



US00D851620S

(12) **United States Design Patent**
Wang et al.

(10) **Patent No.:** **US D851,620 S**
(45) **Date of Patent:** **** Jun. 18, 2019**

(54) **SOUND EQUIPMENT**

(71) Applicants: **Liming Wang**, Guangdong (CN);
Qinming Zhang, Guangdong (CN)

(72) Inventors: **Liming Wang**, Guangdong (CN);
Qinming Zhang, Guangdong (CN)

(**) Term: **15 Years**

(21) Appl. No.: **29/614,029**

(22) Filed: **Aug. 15, 2017**

(30) **Foreign Application Priority Data**

Jun. 27, 2017 (CN) 2017 3 0273037

(51) **LOC (11) Cl.** **14-01**

(52) **U.S. Cl.**
USPC **D14/204**

(58) **Field of Classification Search**
USPC D14/167, 168, 170–172, 188, 204, 210,
D14/214; 181/143, 144, 148, 153, 157,
181/198, 199; 369/6–12; 381/300–303,
381/361–364, 366, 386–388
CPC H04R 1/02; H04R 1/021; H04R 1/025;
H04R 1/026; H04R 1/028; H04R 1/403;
H04R 1/2803; H04R 1/2834; H04R 5/02;
H04R 9/06; H04R 19/013; H04R
2400/00; G06F 1/1688

See application file for complete search history.

(56) **References Cited**

U.S. PATENT DOCUMENTS

D372,917 S * 8/1996 Kobayashi D14/214
D504,409 S * 4/2005 Kim D14/203.3
D532,426 S * 11/2006 Lee D14/203.3
D611,450 S * 3/2010 Miyazaki D14/209.1
D670,264 S * 11/2012 Tsai D14/172
D709,854 S 7/2014 Pan

D710,386 S 8/2014 Aglassinger
D710,387 S 8/2014 Aglassinger
D710,898 S 8/2014 Aglassinger
D714,253 S 8/2014 Aglassinger
D718,748 S 12/2014 Pan
D723,462 S * 3/2015 Druker D13/108
D731,463 S * 6/2015 Ho D14/214
D755,155 S * 5/2016 Paterson D14/204
D760,703 S 7/2016 Aglassinger
D761,234 S 7/2016 Aglassinger et al.
D767,635 S 9/2016 Aglassinger et al.

* cited by examiner

Primary Examiner — Derrick E Holland

Assistant Examiner — Janice Patyk

(74) *Attorney, Agent, or Firm* — Kirk A. Buhler; Buhler & Associates

(57) **CLAIM**

The ornamental design for a sound equipment, as shown and described.

DESCRIPTION

FIG. 1 is a front perspective view of a sound equipment, showing our new design;
FIG. 2 is a front elevation view thereof;
FIG. 3 is a top plan view thereof;
FIG. 4 is a bottom plan view thereof;
FIG. 5 is a rear elevation view thereof;
FIG. 6 is a side elevation view thereof;
FIG. 7 is an opposite side elevation view thereof; and,
FIG. 8 is a partially enlarged top plan view thereof, taken from FIG. 3.

The broken lines in FIGS. 3 and 8 are included to show partially enlarged views only and form no part of the claimed design.

The broken lines in the figures illustrate the portions of the design that form no part of the claimed design.

1 Claim, 8 Drawing Sheets

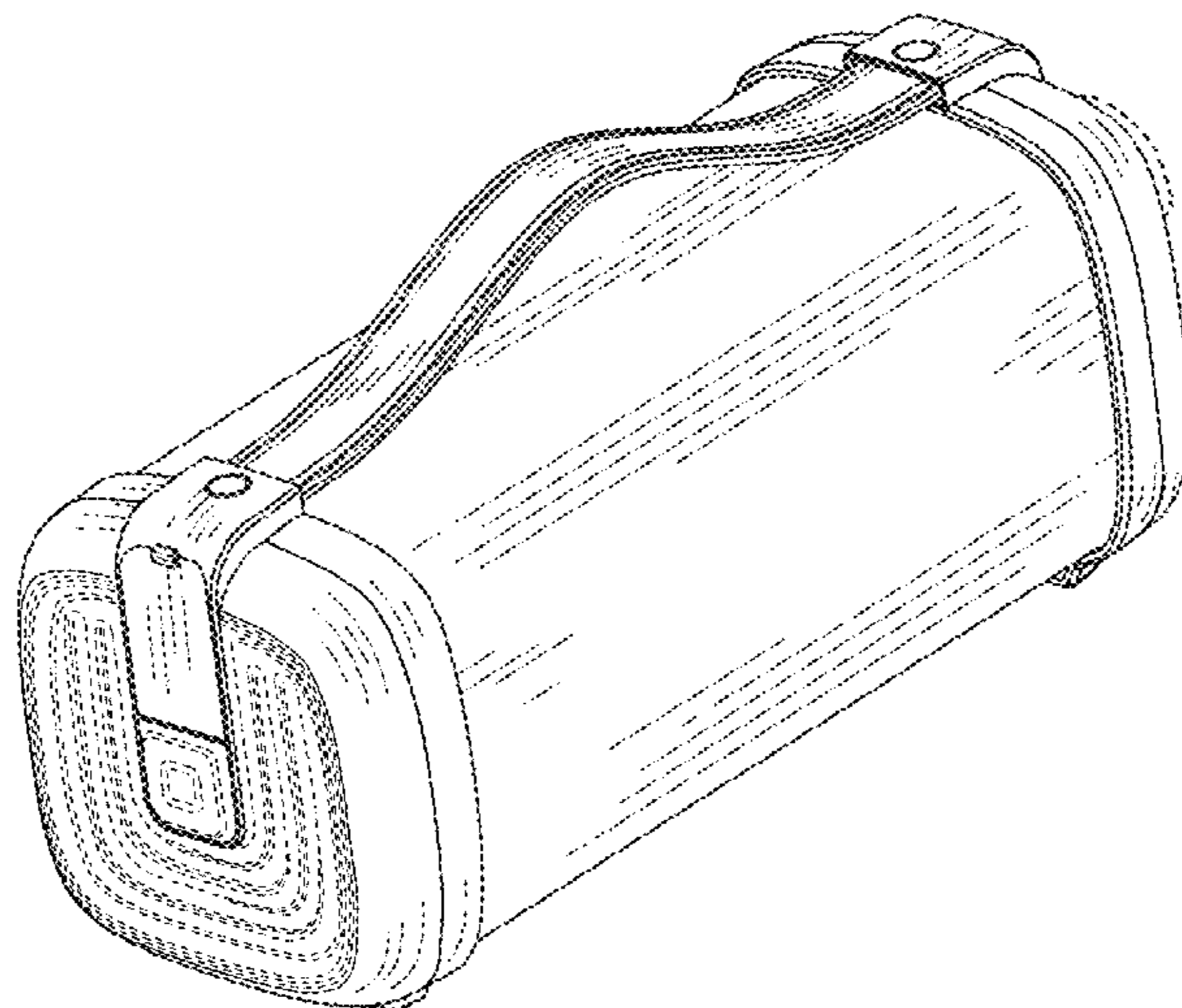

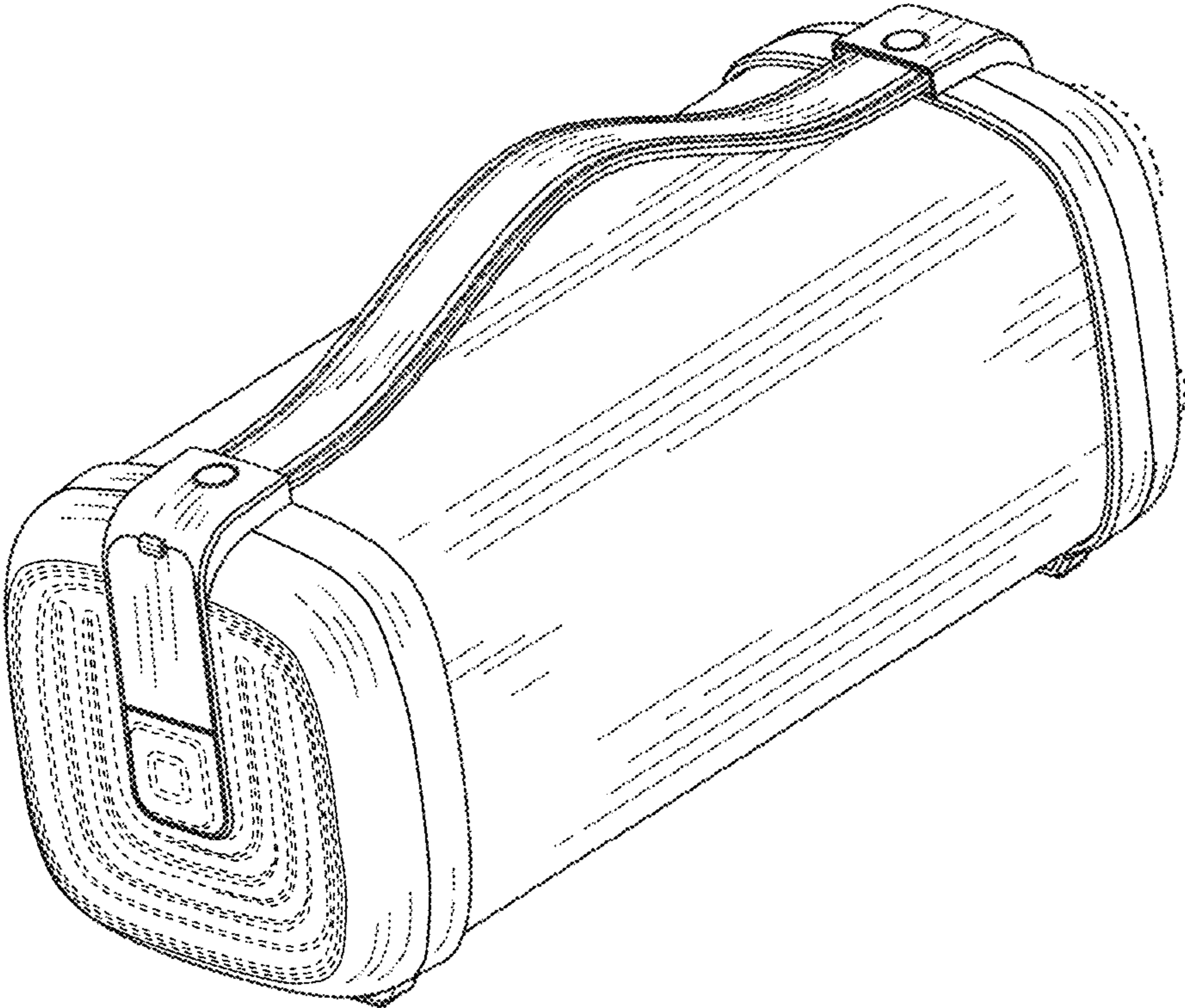

FIG 1

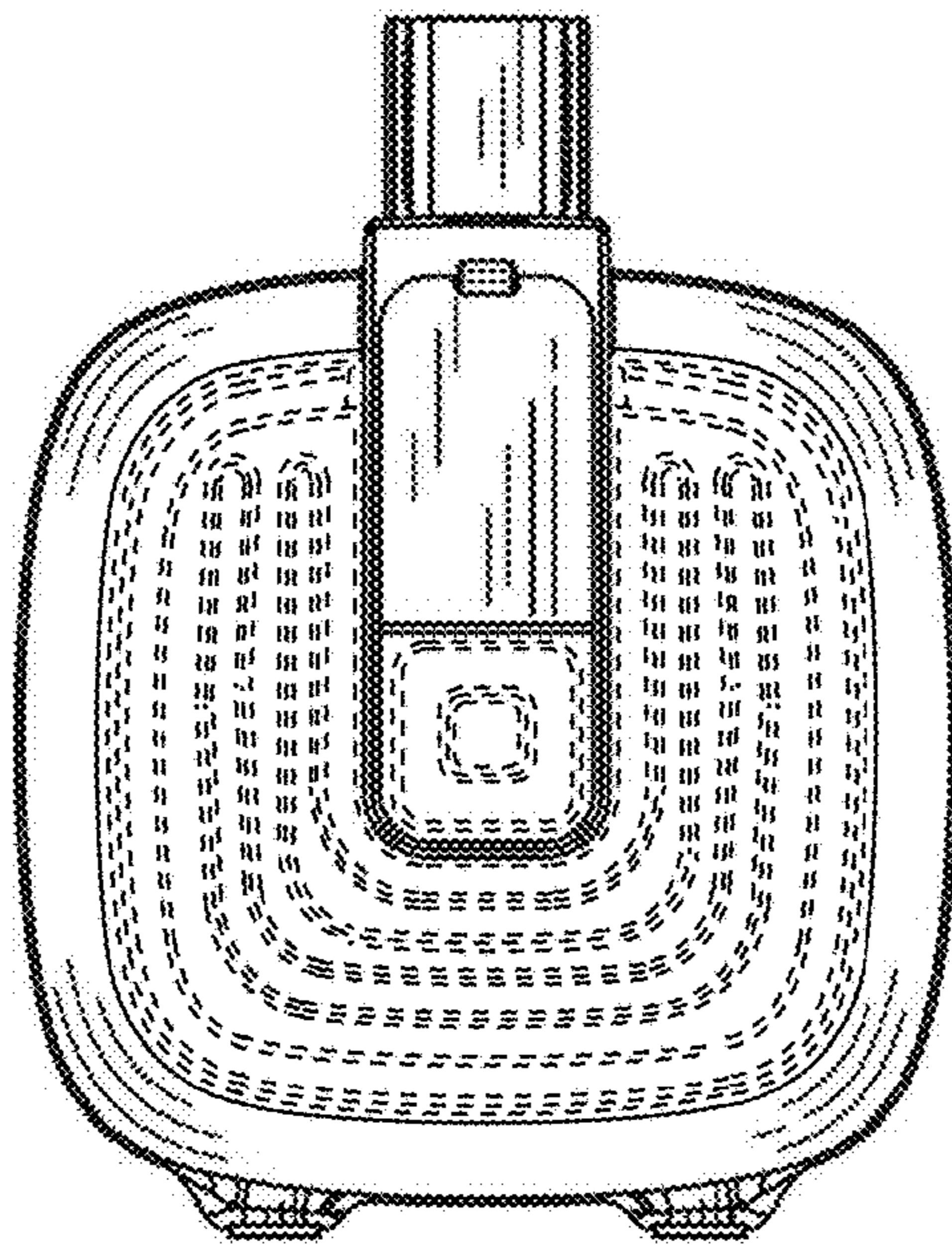

FIG. 2

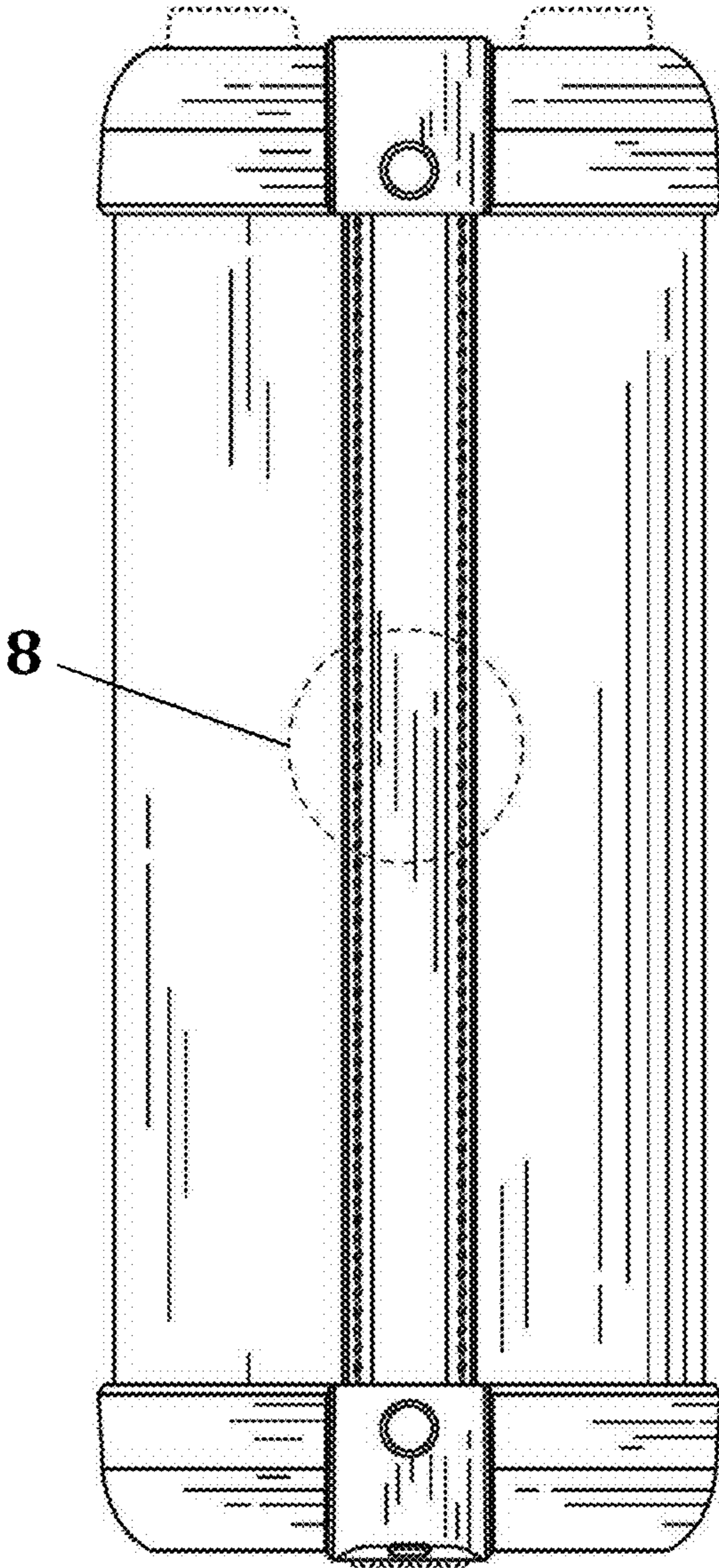

FIG 3

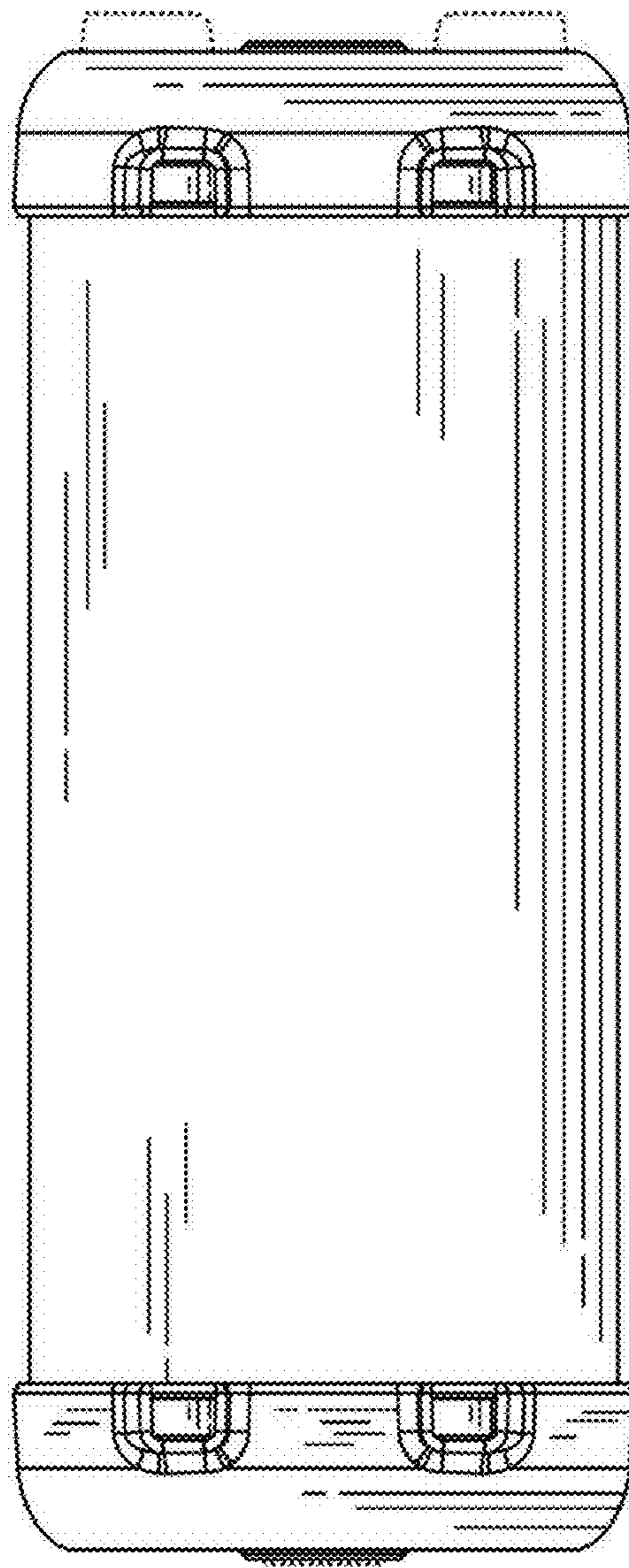

FIG. 4

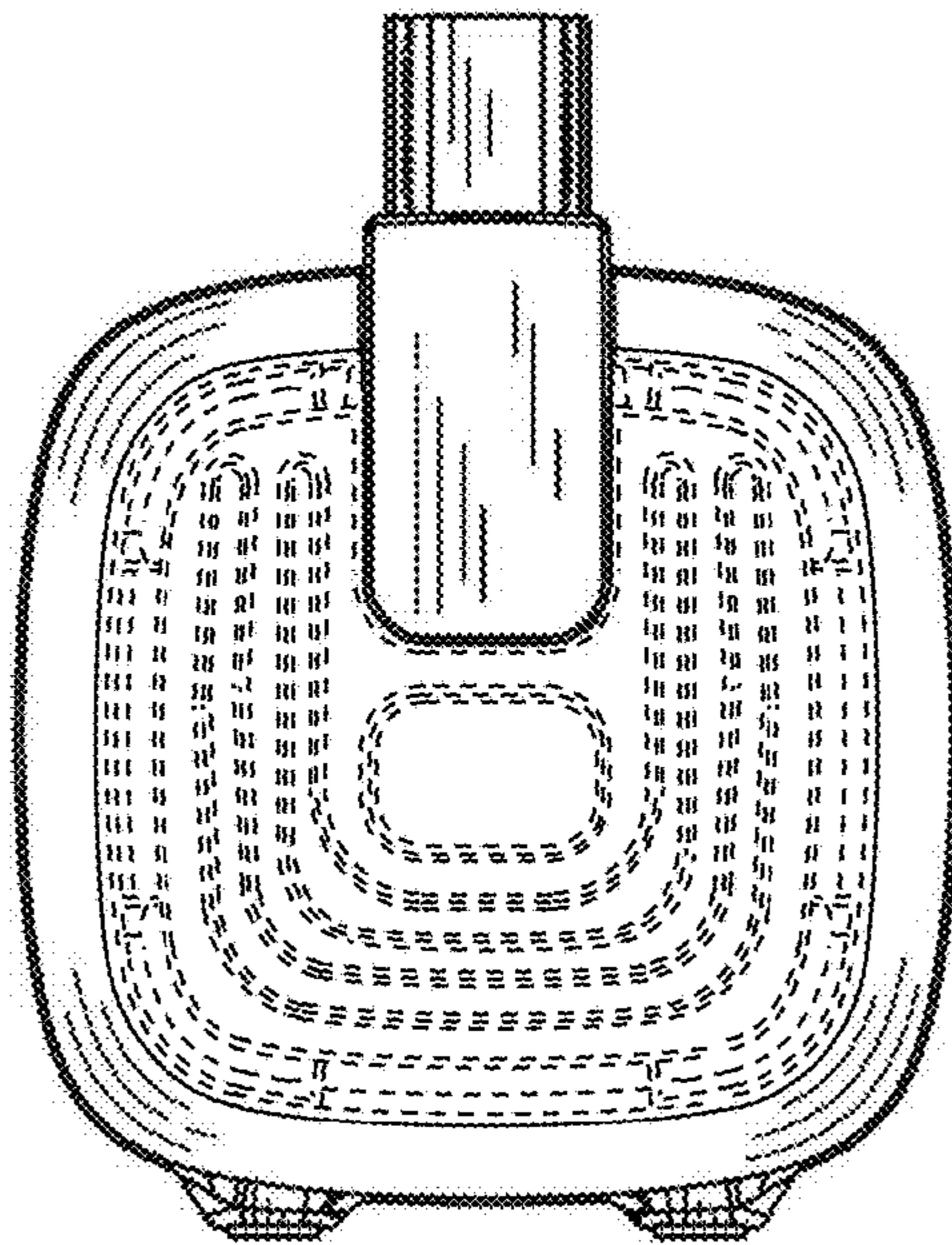

FIG. 5

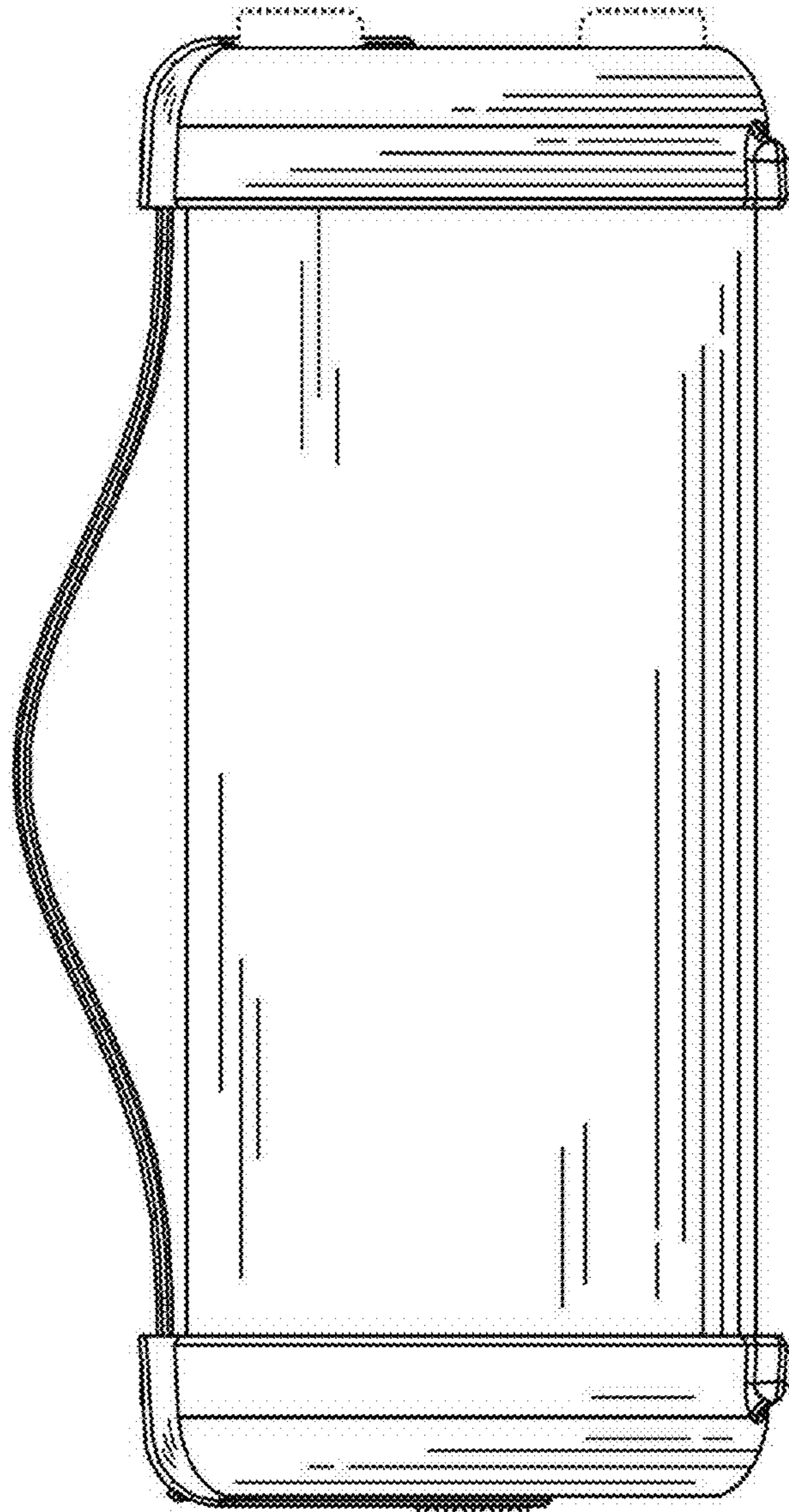

FIG. 6

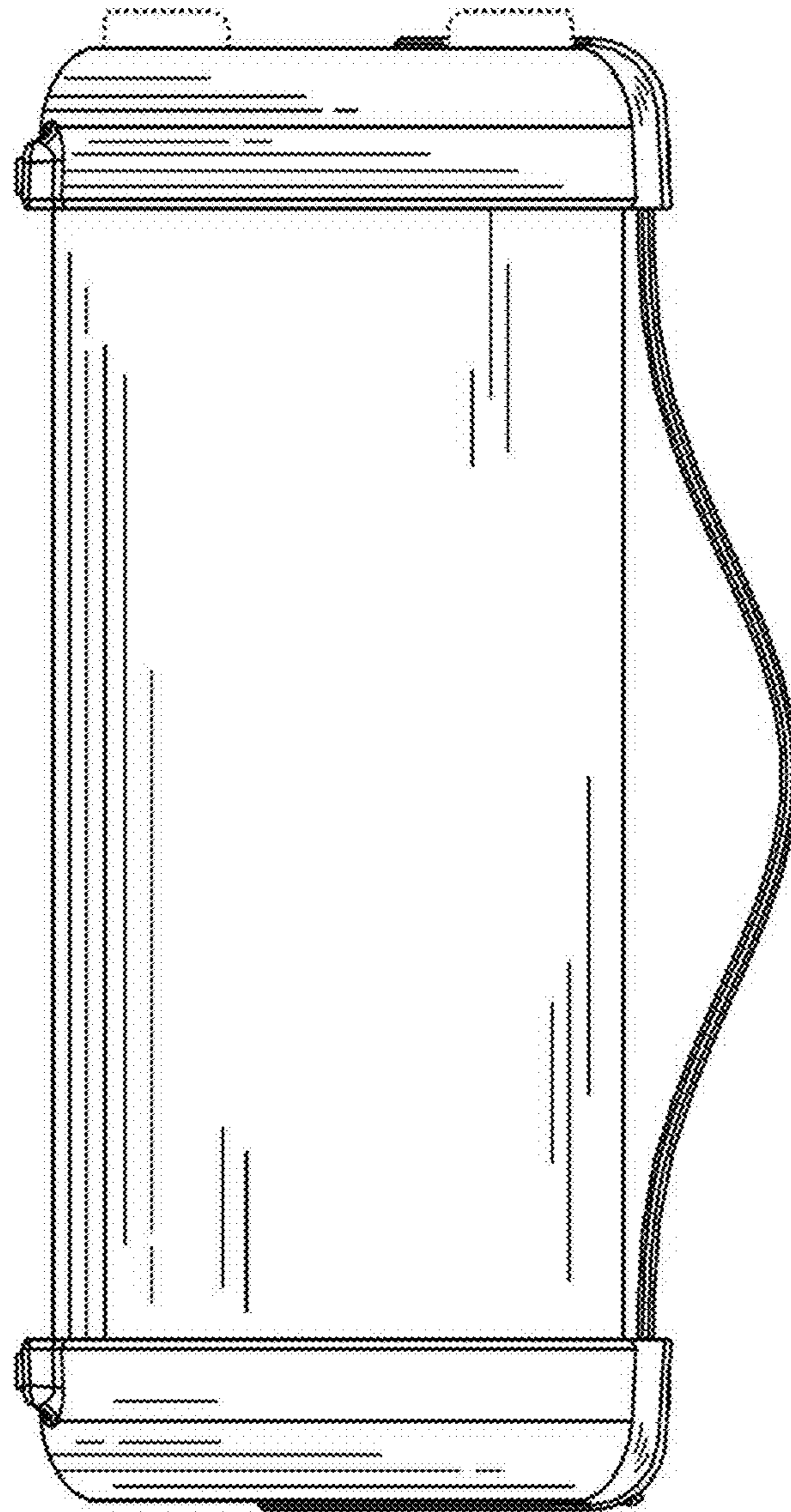

FIG 7

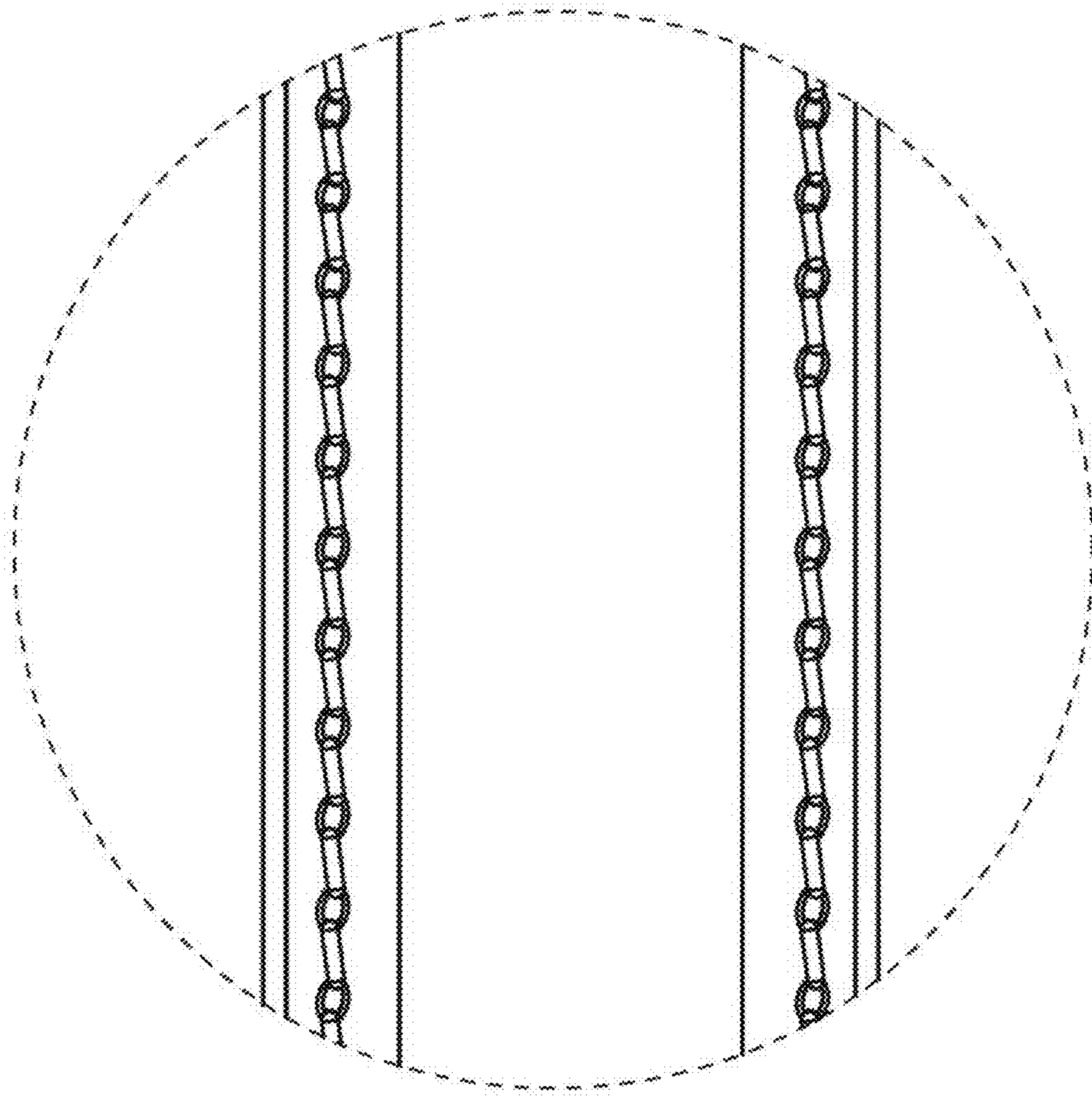

FIG. 8