



US00D851581S

(12) **United States Design Patent**
Sakamoto et al.

(10) **Patent No.:** **US D851,581 S**
(45) **Date of Patent:** **** Jun. 18, 2019**

(54) **AUTOMOBILE TIRE**

D728,457 S * 5/2015 Reim D12/580
D788,026 S * 5/2017 Lundgren D12/605
D805,024 S * 12/2017 Lo D12/579

(71) Applicant: **The Yokohama Rubber Co., Ltd.**,
Minato-ku, Tokyo (JP)

(72) Inventors: **Yosuke Sakamoto**, Hiratsuka (JP);
Noboru Kuwahara, Tokyo (JP)

(73) Assignee: **The Yokohama Rubber Co., Ltd.** (JP)

(**) Term: **15 Years**

(21) Appl. No.: **29/611,190**

(22) Filed: **Jul. 19, 2017**

(30) **Foreign Application Priority Data**

Jan. 20, 2017 (JP) 2017-000894

(51) **LOC (11) Cl.** **12-15**

(52) **U.S. Cl.**
USPC **D12/604**

(58) **Field of Classification Search**
USPC D12/579, 600, 602, 604, 605
CPC B60C 11/032; B60C 11/0388
See application file for complete search history.

(56) **References Cited**

U.S. PATENT DOCUMENTS

D414,727 S * 10/1999 Brown D12/579
D498,208 S * 11/2004 Cazin-Bourguignon D12/600
D520,939 S * 5/2006 Allen D12/600
D653,200 S * 1/2012 Kuwano D12/605

OTHER PUBLICATIONS

Design U.S. Appl. No. 29/611,177, by Sakamoto et al., filed Jul. 17, 2017.

Design U.S. Appl. No. 29/611,179, by Sakamoto et al., filed Jul. 17, 2017.

* cited by examiner

Primary Examiner — Robert M. Spear

(74) *Attorney, Agent, or Firm* — RatnerPrestia

(57) **CLAIM**

The ornamental design for an automobile tire, as shown and described.

DESCRIPTION

FIG. 1 is a perspective view of an automobile tire showing our new design;

FIG. 2 is a front view thereof;

FIG. 3 is a rear view thereof;

FIG. 4 is a top plan view thereof;

FIG. 5 is a bottom plan views thereof;

FIG. 6 is a left side view thereof;

FIG. 7 is a right side view thereof; and,

FIG. 8 is an enlarged fragmental perspective view taken along lines 8-8 in FIG. 1.

The dashed broken lines in the drawings are for the purpose of illustrating unclaimed portions of the tire and form no part of the claimed design.

1 Claim, 6 Drawing Sheets

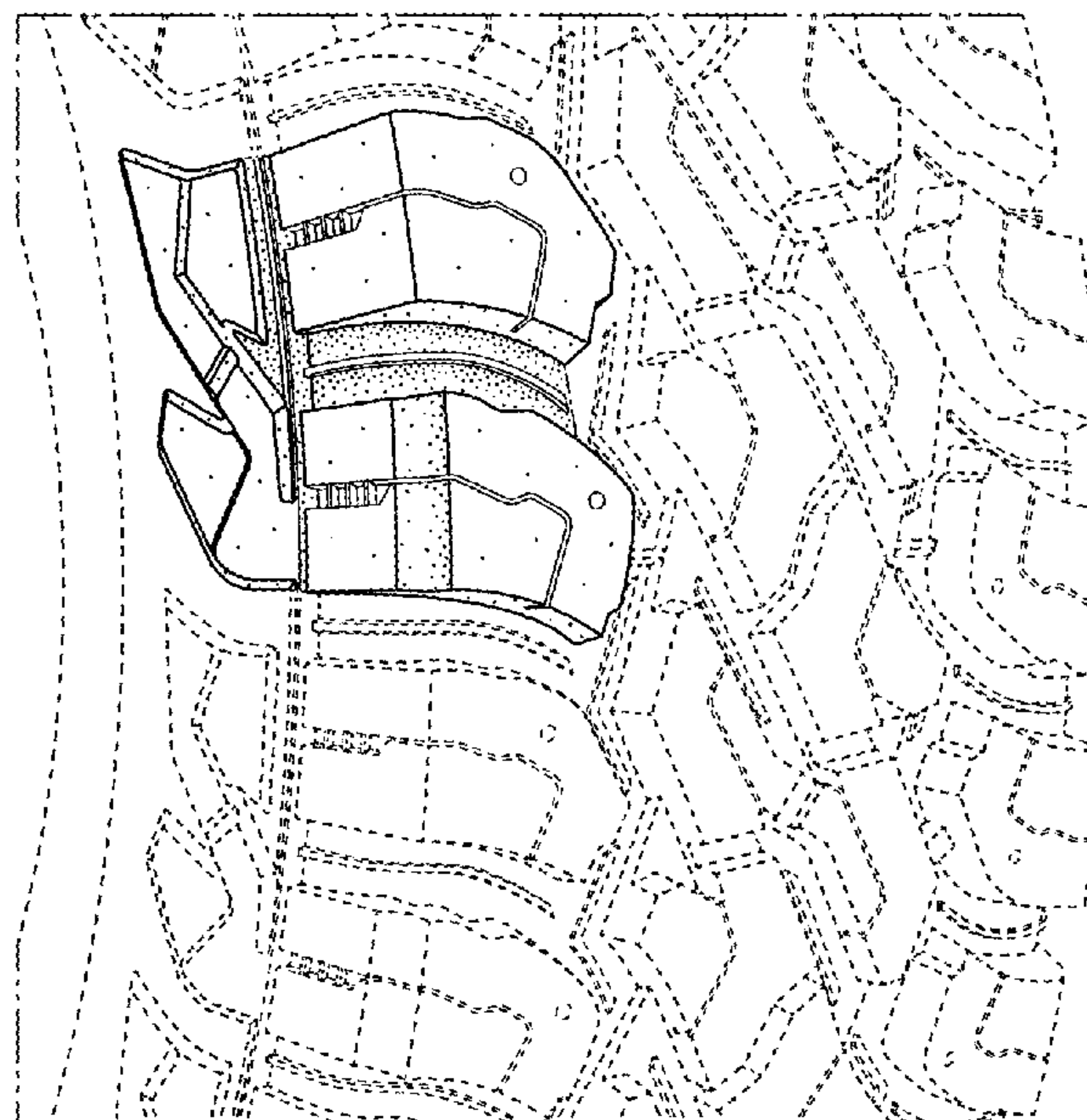

FIG. 1

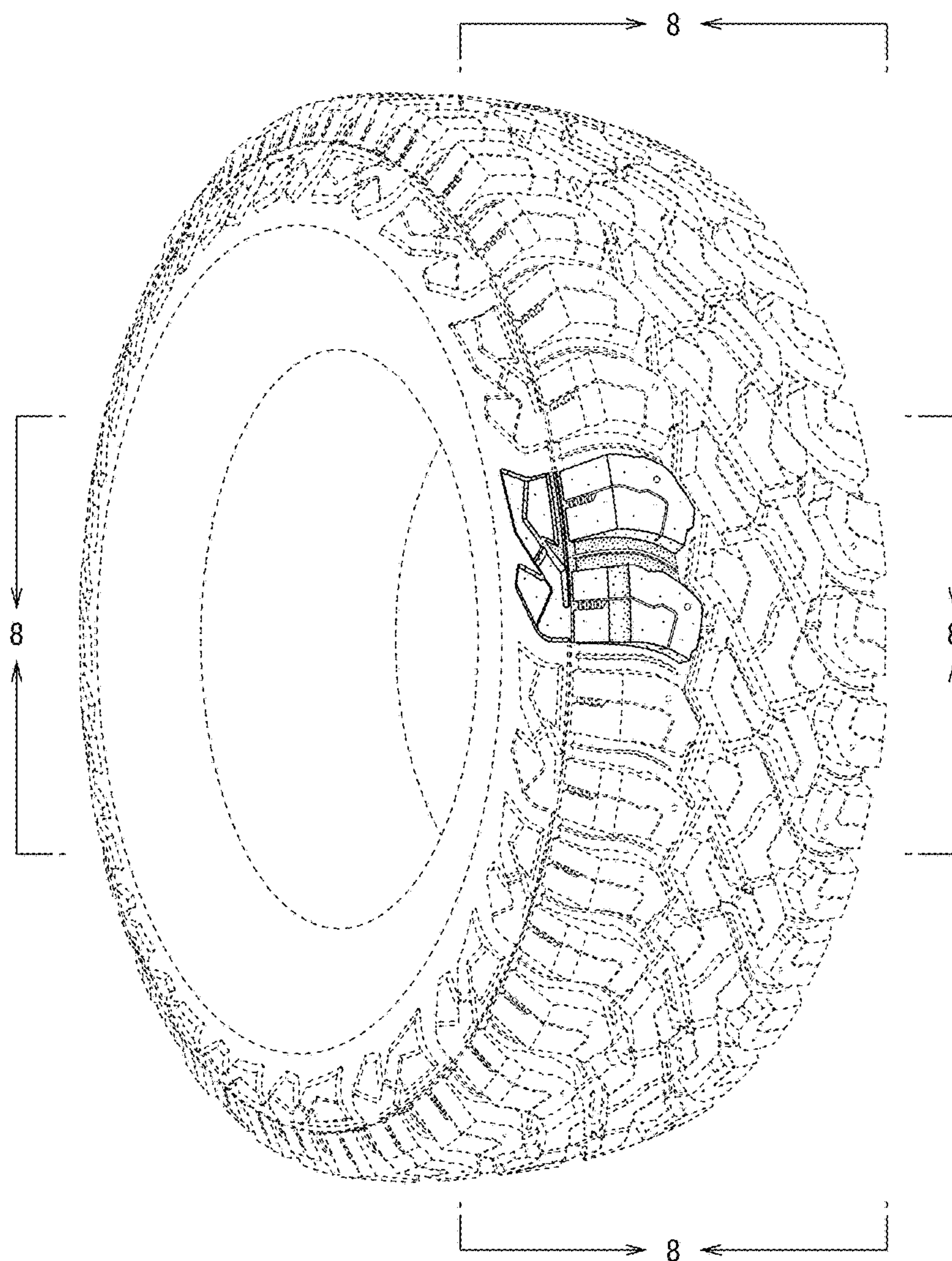

FIG. 2

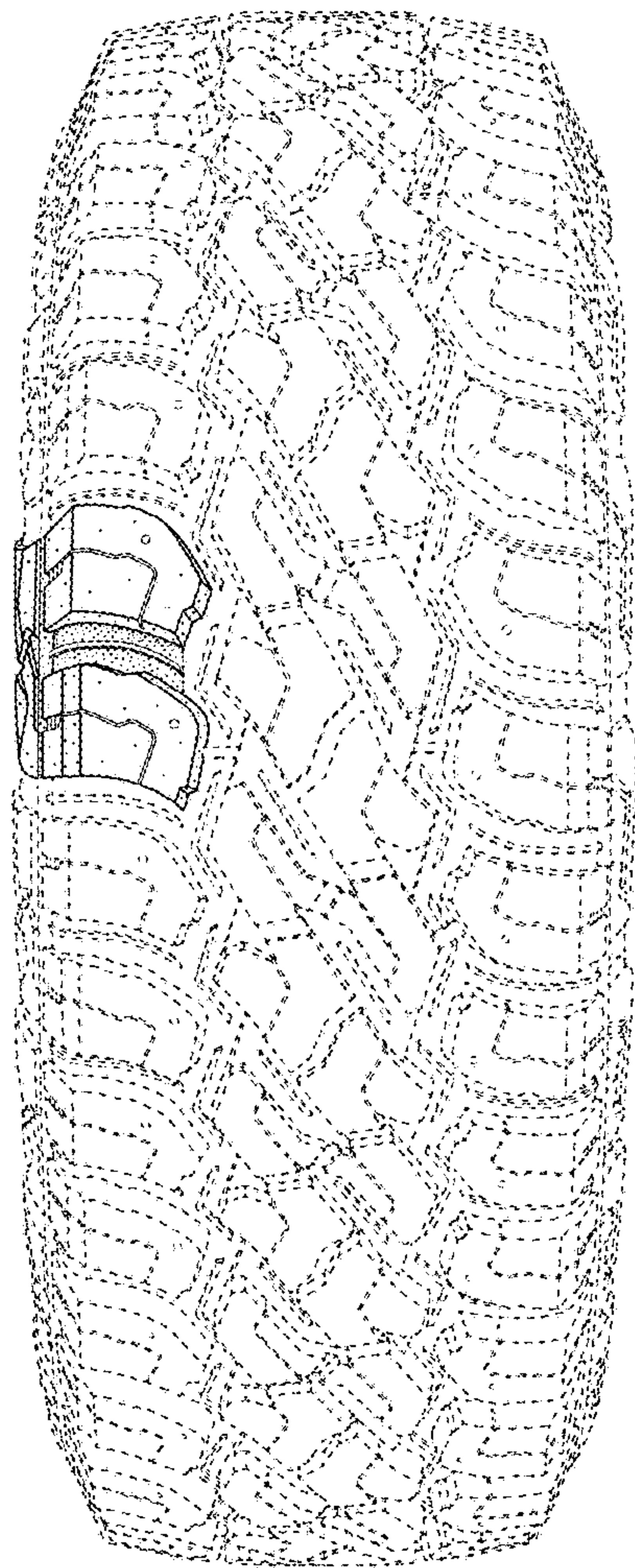

FIG. 3

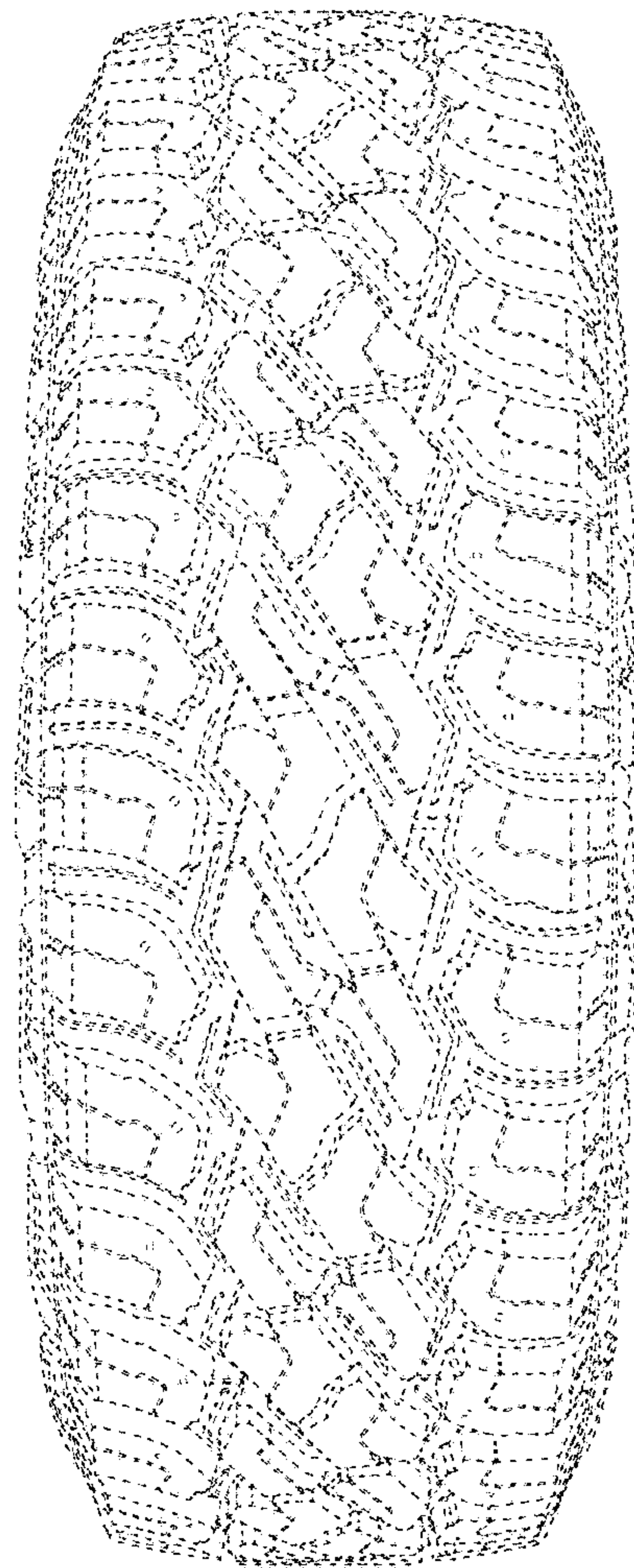

FIG. 4

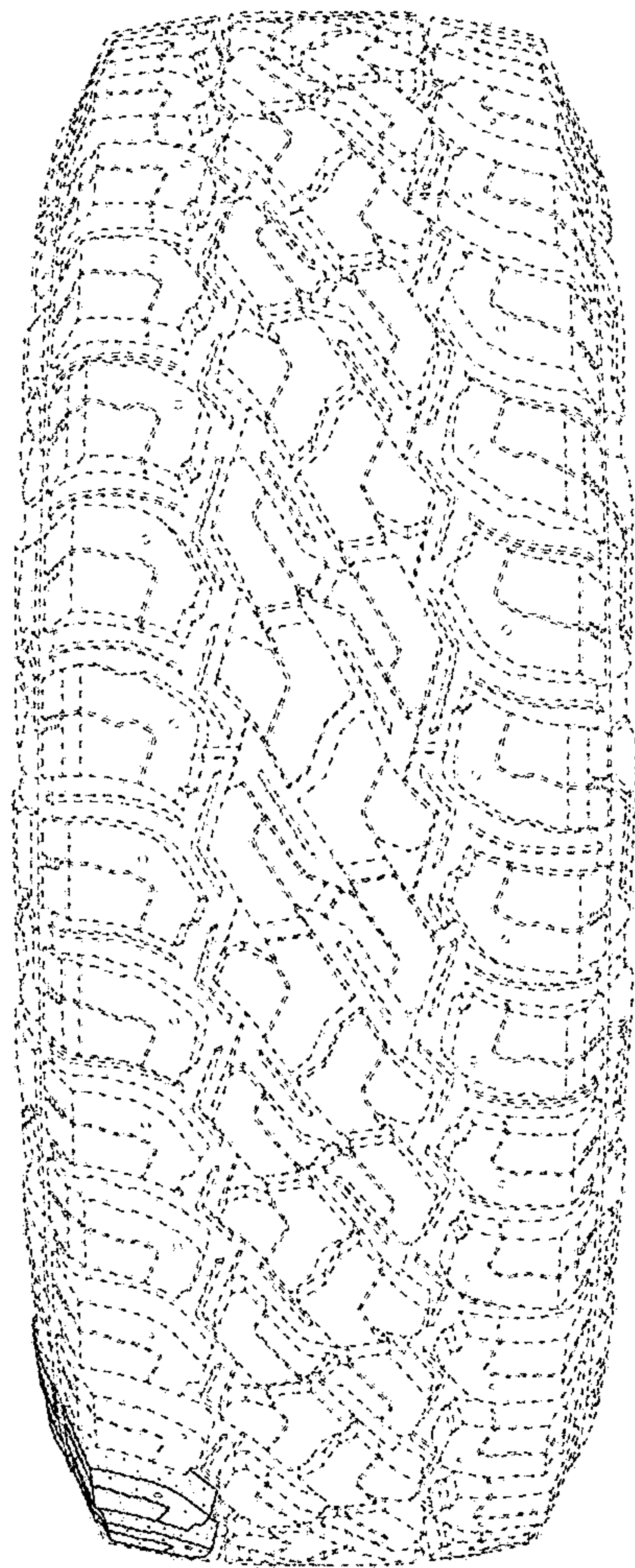

FIG. 5

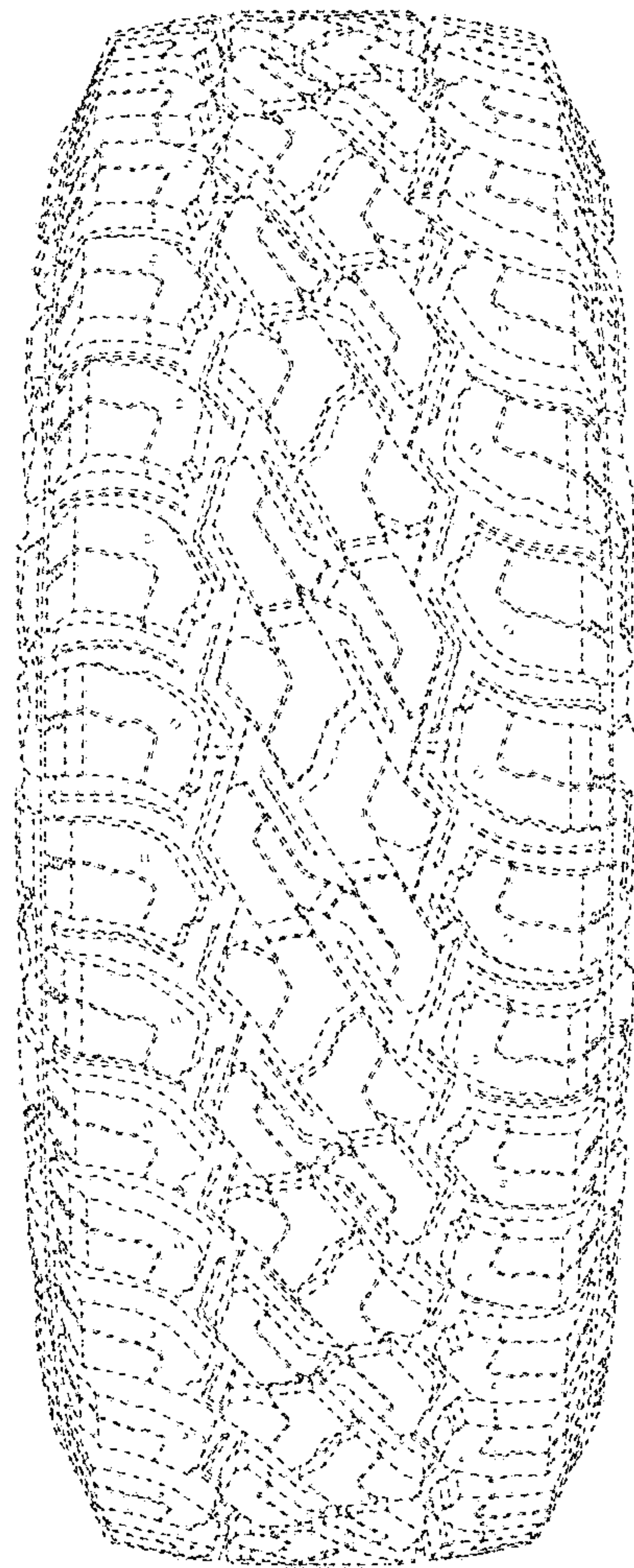

FIG. 6

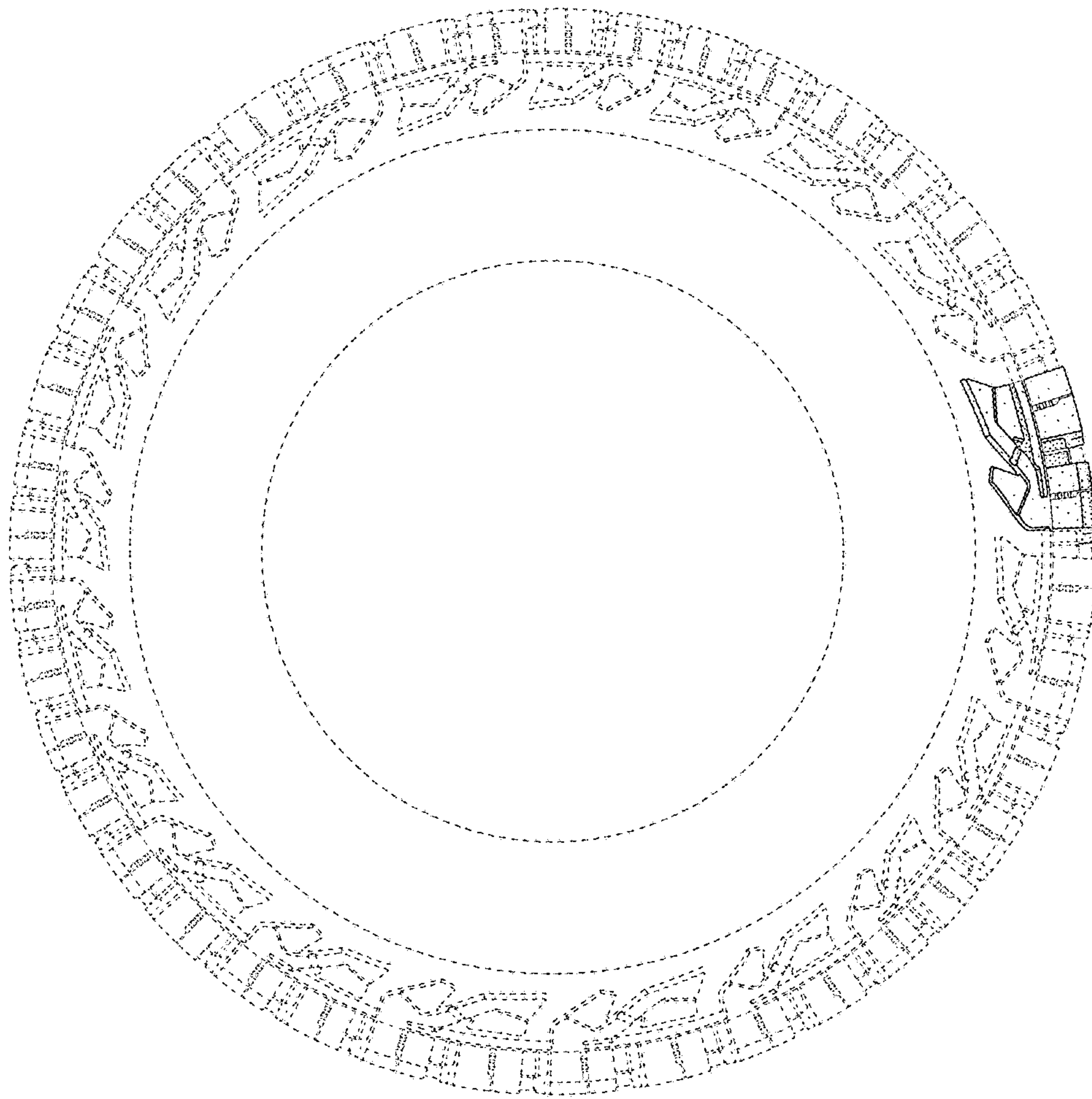

FIG. 7

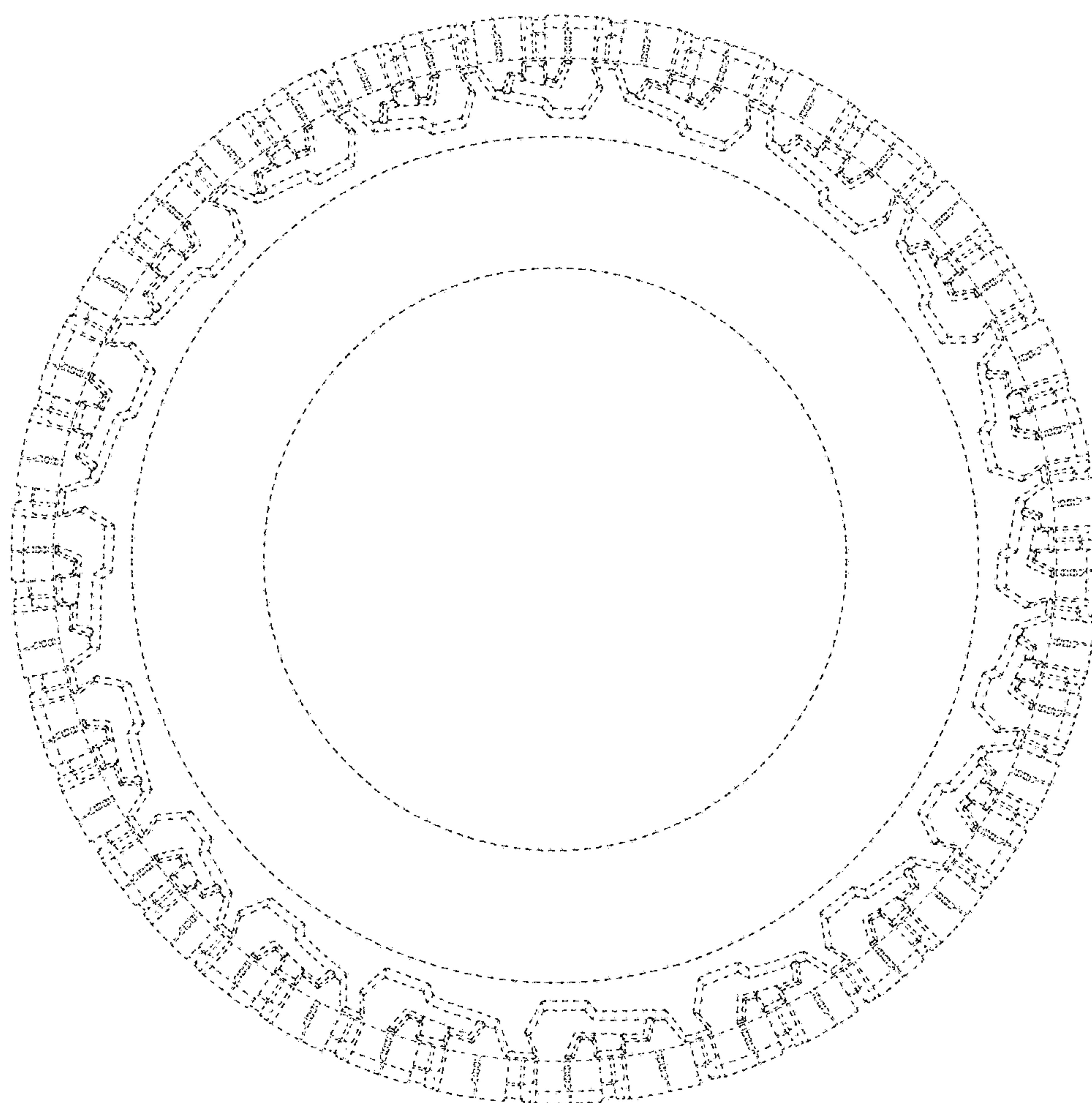

FIG. 8

