



US00D851449S

(12) **United States Design Patent**
Ko et al.

(10) **Patent No.:** **US D851,449 S**
(45) **Date of Patent:** **** Jun. 18, 2019**

(54) **BACK PANEL FOR CLAMSHELL GRIDDLE**

(71) Applicant: **KCP FOOD (U.S.) INC.**, New York, NY (US)

(72) Inventors: **Richard Ko**, Lexington, MA (US);
Wilson Suen, Ontario (CA)

(73) Assignee: **KCP Food (U.S.) Inc.**, New York, NY (US)

(**) Term: **15 Years**

(21) Appl. No.: **29/614,330**

(22) Filed: **Aug. 17, 2017**

(51) **LOC (11) Cl.** **07-02**

(52) **U.S. Cl.**
USPC **D7/405**

(58) **Field of Classification Search**
USPC D7/402-409, 332, 337, 339-341,
D7/346-349, 350.1-351, 362-363, 323,
D7/550.1, 552.1, 554.3, 554.4; D8/315,
D8/300
CPC A47J 37/0786; F24C 15/16; F24C 3/082;
F24C 3/085; F24C 7/083
See application file for complete search history.

(56) **References Cited**

U.S. PATENT DOCUMENTS

D302,923 S * 8/1989 Schmidt D7/552.1
5,911,812 A * 6/1999 Stanek A47J 37/067
126/25 R
D427,008 S * 6/2000 Wasner D7/339
D498,387 S * 11/2004 Hojnoski D7/402

D679,133 S * 4/2013 Borovicka D7/402
D758,798 S * 6/2016 Hunt D7/352
D778,110 S * 2/2017 Lee D7/406
D786,014 S * 5/2017 Knight D7/405
D825,263 S * 8/2018 Funnell, II D7/402
2007/0113837 A1* 5/2007 Liu A47J 36/12
126/25 R
2013/0319398 A1* 12/2013 Braden F24C 15/04
126/200

* cited by examiner

Primary Examiner — Sheryl Lane

Assistant Examiner — Nicole C Shiflet

(74) *Attorney, Agent, or Firm* — Tarter Krinsky & Drogin LLP

(57) **CLAIM**

The ornamental design for a back panel for a clamshell griddle, as shown and described.

DESCRIPTION

FIG. 1 is a front perspective view of a back panel for a clamshell griddle;
FIG. 2 is a front view thereof;
FIG. 3 is a first side view thereof;
FIG. 4 is a second side view thereof;
FIG. 5 is a top view thereof;
FIG. 6 is a bottom view thereof; and,
FIG. 7 is a perspective view of the back panel being used in conjunction with a clamshell griddle.
The broken lines showing environment form no part of the claimed design.

1 Claim, 6 Drawing Sheets

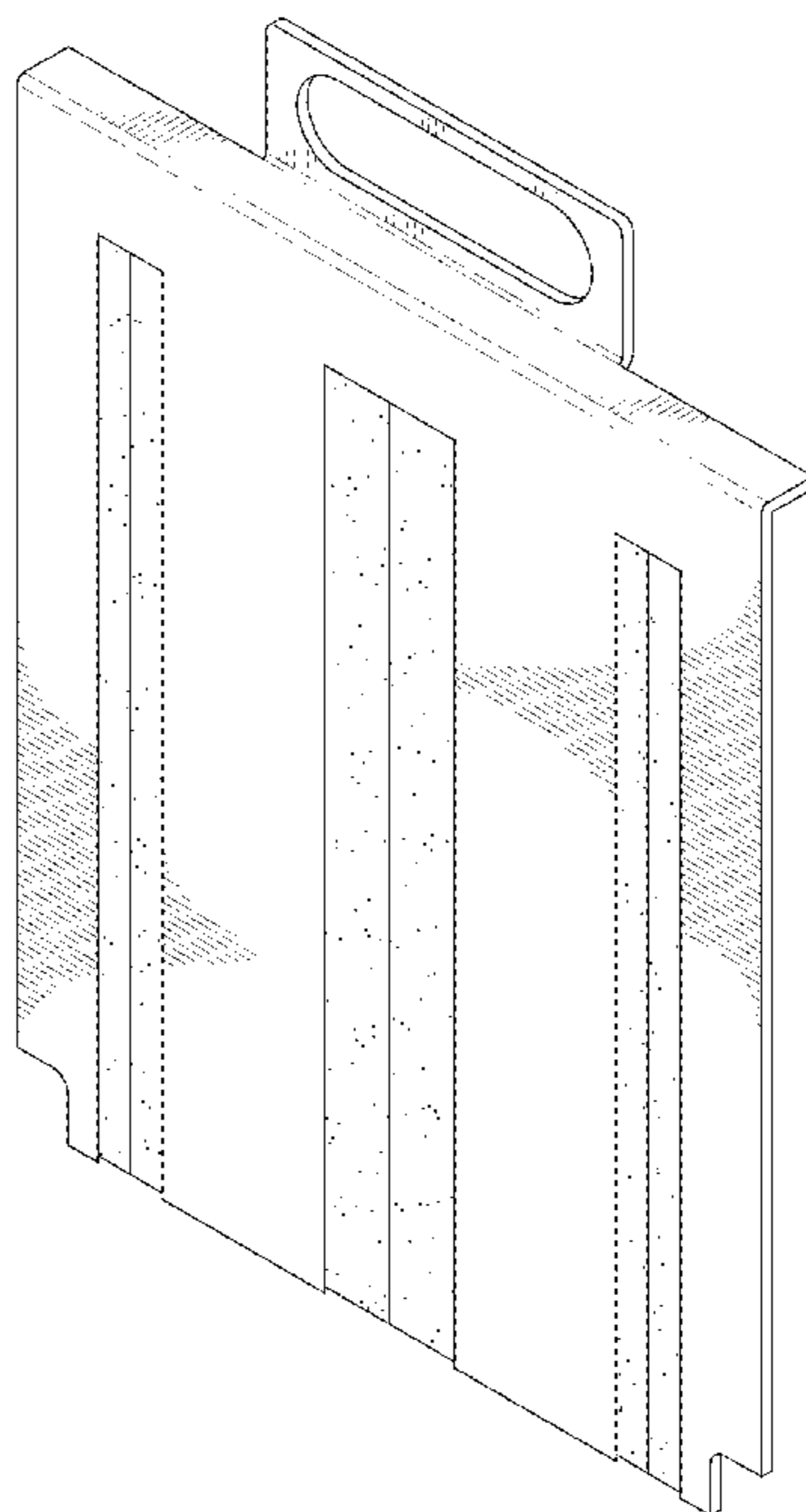

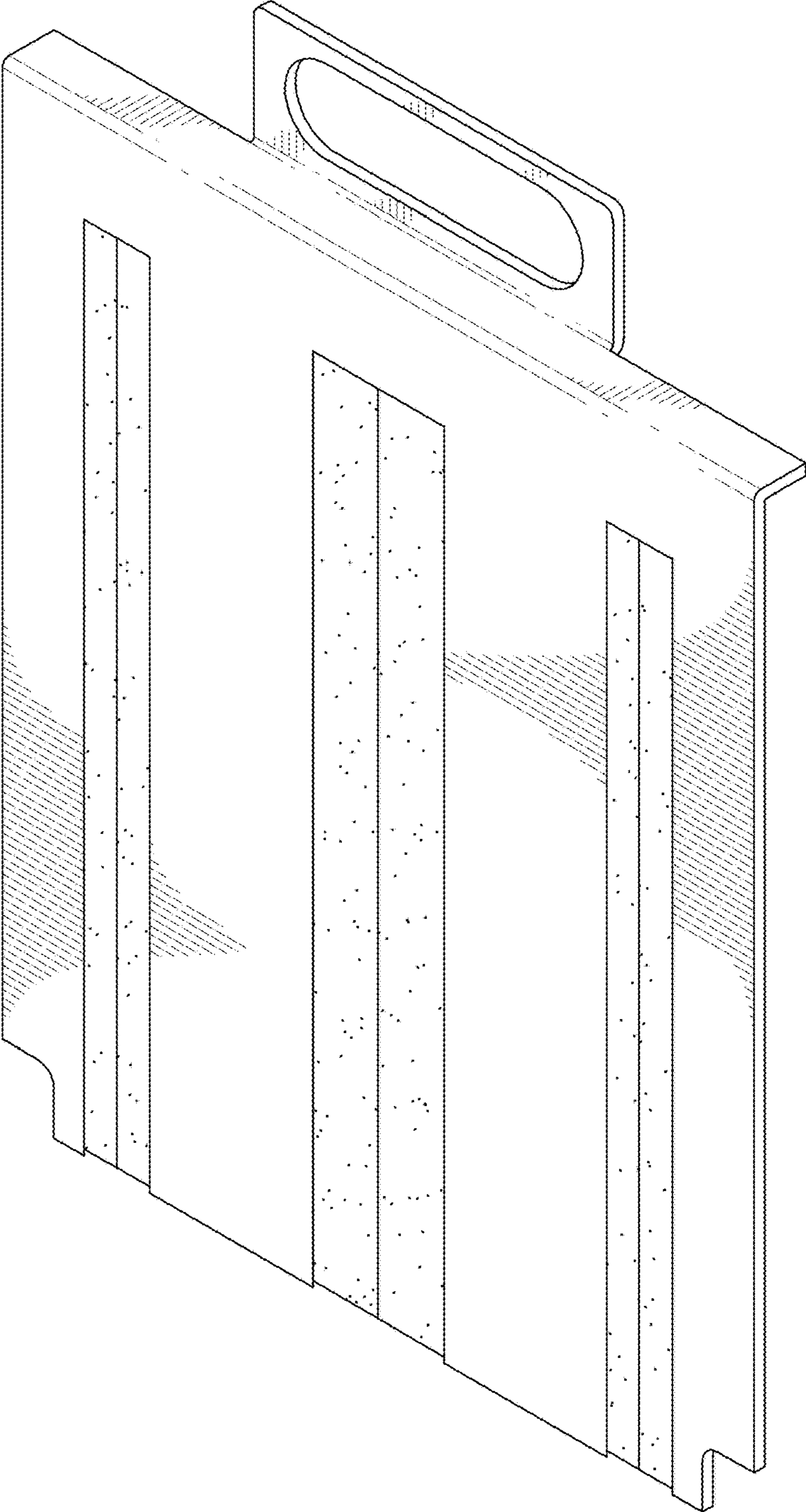

FIG. 1

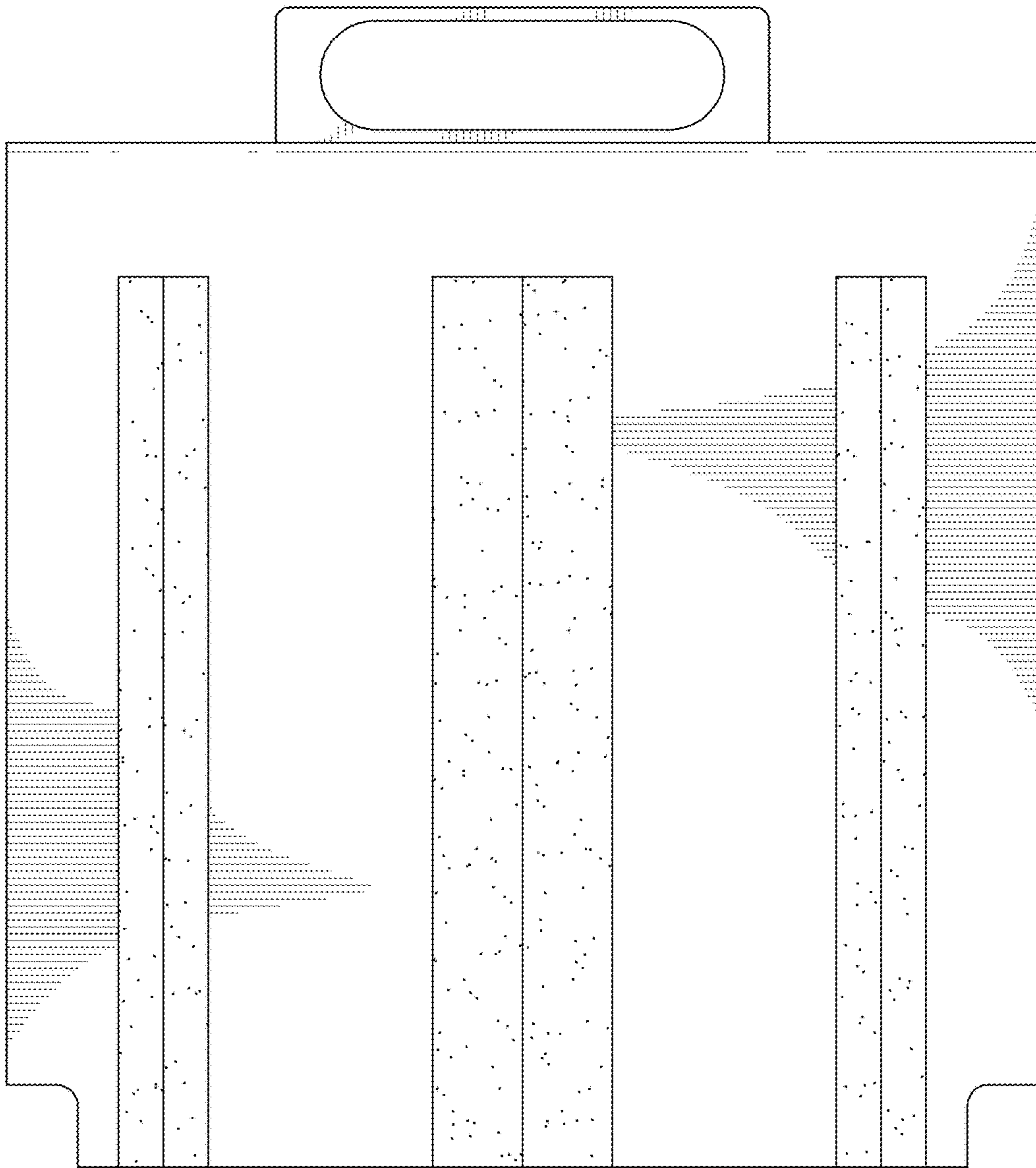

FIG.2

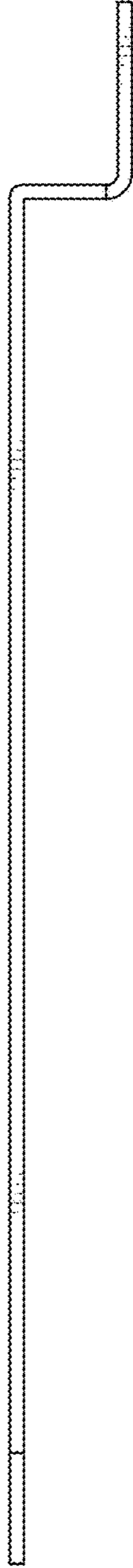

FIG. 3

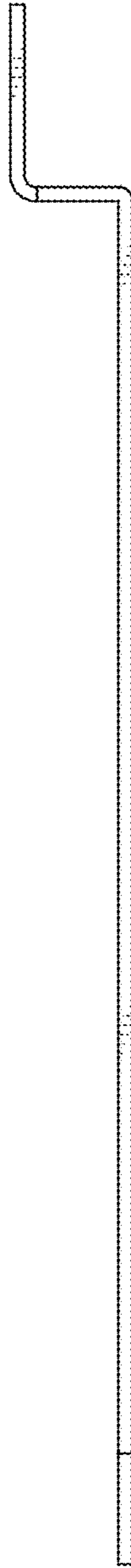

FIG.4

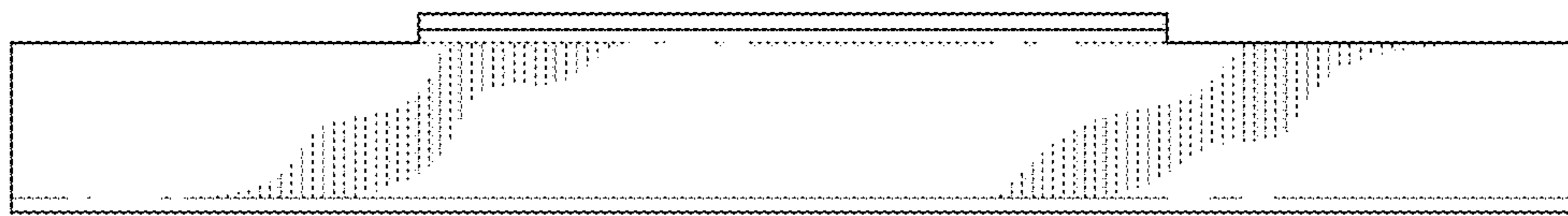

FIG. 5

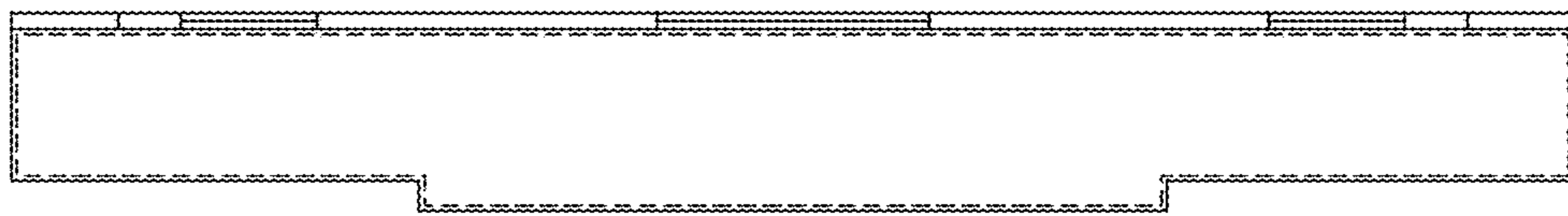

FIG. 6

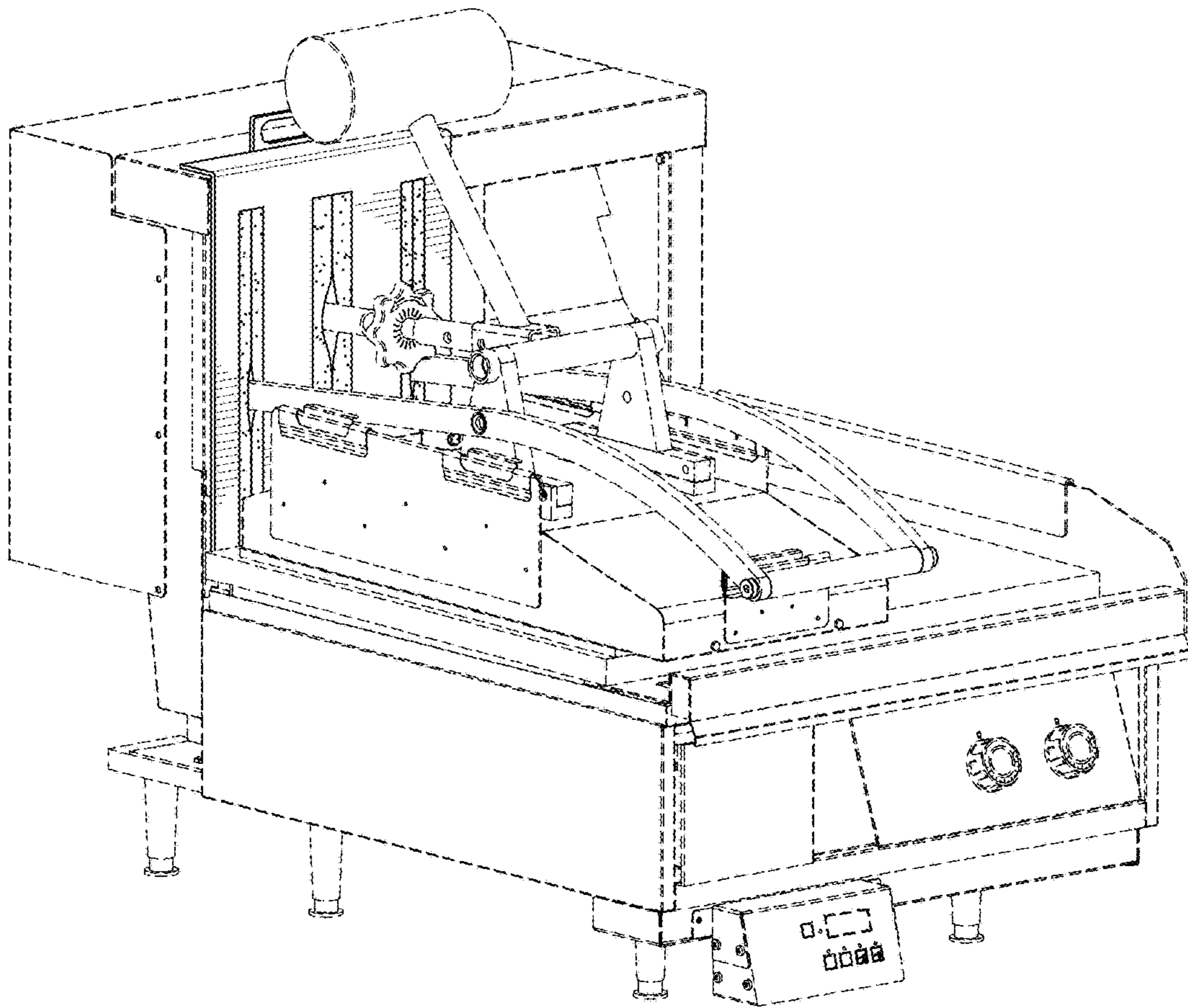

FIG.7