



US00D851445S

(12) **United States Design Patent**
Silsby

(10) **Patent No.:** **US D851,445 S**

(45) **Date of Patent:** **** Jun. 18, 2019**

(54) **BEVERAGE CONTAINER LID**

- (71) Applicant: **Pacific Market International, LLC**,
Seattle, WA (US)
- (72) Inventor: **Jacob D. Silsby**, Seattle, WA (US)
- (73) Assignee: **PACIFIC MARKET INTERNATIONAL, LLC**, Seattle, WA (US)
- (**) Term: **15 Years**

(21) Appl. No.: **29/599,788**

(22) Filed: **Apr. 6, 2017**

(51) **LOC (11) Cl.** **07-99**

(52) **U.S. Cl.**
USPC **D7/392.1; D9/449**

(58) **Field of Classification Search**
USPC D3/202; D7/300, 300.1, 313, 314, 316, D7/387, 392.1, 393, 396, 396.1, 396.2, D7/397, 398, 401.1, 509, 510, 511, 523, D7/525, 526, 527, 528, 536, 538, 900; D9/434, 435, 436, 437, 438, 440, 443, D9/446, 447, 448, 449, 452, 453, 454, D9/686, 688, 690, 723, 724, 763, 772
CPC B65D 39/00; B65D 39/0005; B65D 39/02; B65D 39/08; B65D 39/14; B65D 39/19; B65D 39/0047; B65D 50/00; B65D 50/041; B65D 21/0228; B65D 51/02; B65D 51/04; B65D 51/18; B65D 51/28; B65D 51/242; B65D 51/2814; B65D 51/2821; B65D 47/0895; B65D 47/148; B65D 47/36; B65D 47/08; B65D 47/265; B65D 43/02; B65D 43/14; B65D 43/16; B65D 43/26; B65D

(Continued)

(56) **References Cited**

U.S. PATENT DOCUMENTS

- D363,666 S * 10/1995 Goto D7/900
- D485,759 S * 1/2004 Janky D7/392.1

(Continued)

OTHER PUBLICATIONS

Hydro Flask Lids: Announced Oct. 8, 2016 [online]. Site Visited [Apr. 1, 2018]. Available from Internet URL: <https://hydrationanywhere.com/easy-guide-to-hydro-flask-lids/>.*

(Continued)

Primary Examiner — Jennifer Rivard
Assistant Examiner — Catherine S Posthauer
 (74) *Attorney, Agent, or Firm* — Davis Wright Tremaine LLP; George C. Rondeau, Jr.

(57) **CLAIM**

The ornamental design for a beverage container lid, as shown and described.

DESCRIPTION

FIG. 1 is a top perspective view of a beverage container lid showing my new design.
 FIG. 2 is a bottom perspective view thereof;
 FIG. 3 is a right side elevational view thereof;
 FIG. 4 is a left side elevational view thereof;
 FIG. 5 is a rear elevational view thereof;
 FIG. 6 is a front elevational view thereof;
 FIG. 7 is a top plan view thereof;
 FIG. 8 is a bottom plan view thereof;
 FIG. 9 is a top perspective view of a second embodiment thereof;
 FIG. 10 is a bottom perspective view thereof;
 FIG. 11 is a right side elevational view thereof;
 FIG. 12 is a left side elevational view thereof;
 FIG. 13 is a rear elevational view thereof;
 FIG. 14 is a front elevational view thereof;
 FIG. 15 is a top plan view thereof; and,
 FIG. 16 is a bottom plan view thereof.
 The broken lines immediately adjacent the shaded surfaces of the article represent boundaries of the claimed design and form no part thereof.

1 Claim, 12 Drawing Sheets

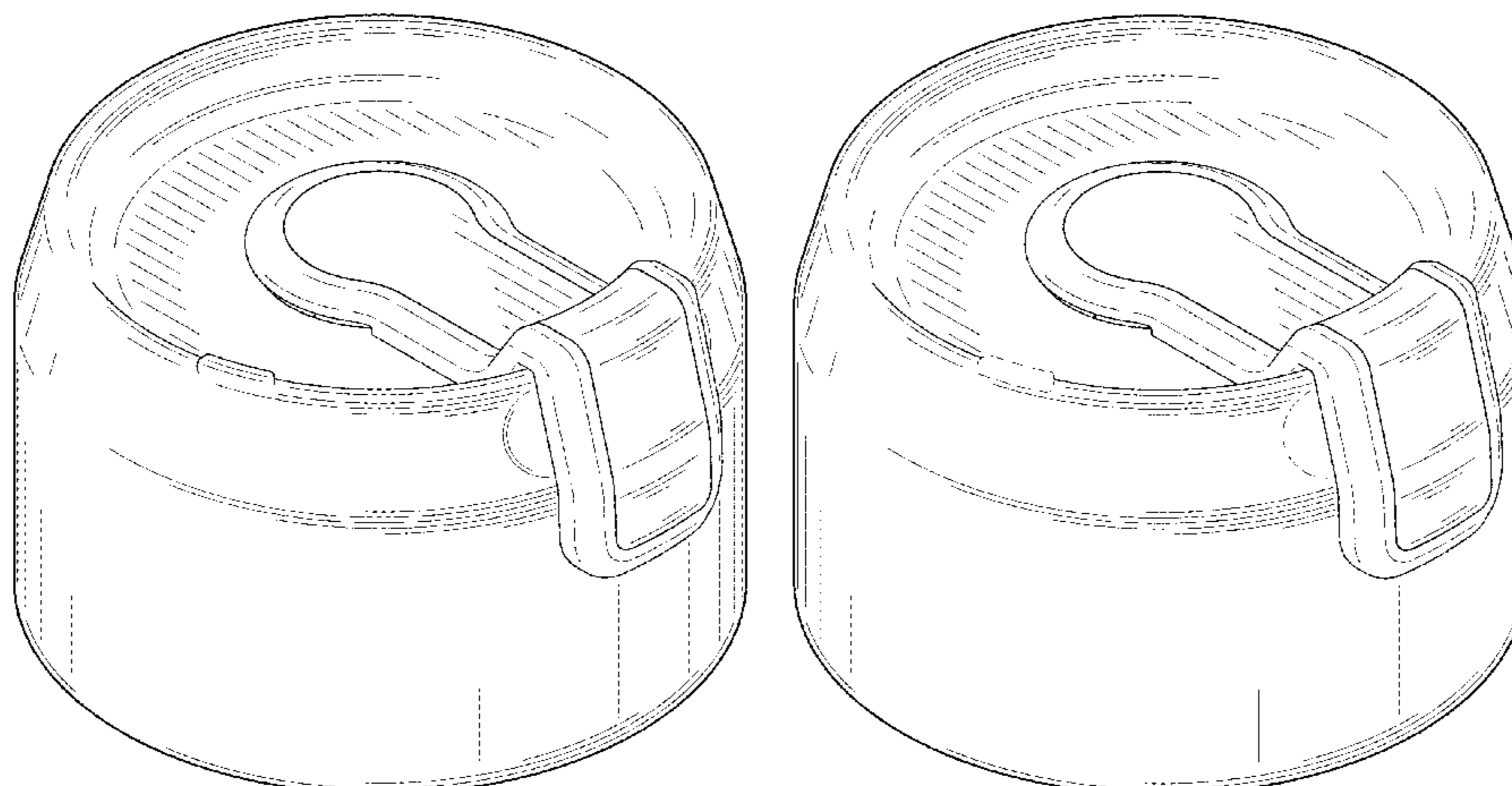

(58) **Field of Classification Search**

CPC 43/0202; B65D 43/0208; B65D 71/00;
 B65D 5/36; B65D 5/503; B65D 53/00;
 B65D 53/02; B65D 53/04; B65D
 2251/0018; B65D 2251/0081; B65D
 2251/0026; B65D 2251/009; B65D 25/00;
 B65D 25/40; B65D 25/42; B65D 25/46;
 B65D 25/48; B65D 25/77; B65D 23/08;
 B65D 83/40; B65D 83/205; B65D
 83/206; B65D 83/345; B65D 2255/00;
 B65D 55/02; B65D 55/024; B65D 41/00;
 B65D 2543/00092; B65D 2543/00351;
 B65D 2543/00555; B65D 2543/00685;
 B65D 2543/00796; B65D 2543/00296;
 B65D 2543/00416; B65D 2543/00638;
 B65D 2543/00731; B65D 41/16; B65D
 41/17; B65D 41/32; B65D 41/26; B65D
 41/0483; B65D 41/0414; B65D 41/0421;
 B65D 41/0485; B65D 41/0492; B65D
 41/0471; B65D 41/0428; B65D 41/3428;
 B65D 41/48; B65D 41/485; B65D
 41/026; B65D 41/003; B65D 41/02;
 B65D 41/045; A47J 43/27; A47J 36/06;
 A47J 36/10; A47J 36/14; A47G 19/22;
 A47G 19/2205; A47G 19/2222; A47G
 19/2266; A47G 19/2272; A47G 19/2294;
 A45D 40/081; A45D 40/0026; A45D
 40/009; A45D 34/00; B65B 11/0032;
 B65B 11/0056; B65B 11/3059; B65B
 11/3097; A61J 2205/50

See application file for complete search history.

(56)

References Cited

U.S. PATENT DOCUMENTS

D490,710 S * 6/2004 Bayer D9/448
 D609,092 S * 2/2010 Laib D9/449
 D623,017 S * 9/2010 George D7/510
 D644,060 S * 8/2011 Komeiji D7/392.1

D647,753 S * 11/2011 Lin D7/392.1
 D691,416 S * 10/2013 Eyal D7/396.2
 D709,734 S * 7/2014 Kotani D7/608
 D719,023 S * 12/2014 Hu D9/449
 D721,535 S * 1/2015 Chapman D7/396.2
 D755,048 S * 5/2016 Baissero D9/449
 9,334,090 B1 * 5/2016 Maple B65D 47/0866
 D761,618 S * 7/2016 Lapsker D7/392.1
 D772,651 S * 11/2016 Leonard D7/510
 9,643,758 B2 * 5/2017 George B65D 43/26
 D789,737 S * 6/2017 Eyal D7/300.1
 D794,455 S * 8/2017 Rummel D9/449
 D801,746 S * 11/2017 Thuma D7/392.1
 D805,838 S * 12/2017 Guthrie D7/392.1
 D806,545 S * 1/2018 Circosta D9/449
 D807,692 S * 1/2018 Yao D7/392.1
 D814,240 S * 4/2018 Kabalin D7/510
 2003/0150834 A1 * 8/2003 Verderber B65D 41/185
 215/254
 2007/0196542 A1 * 8/2007 Rathbone A23G 3/563
 426/106
 2012/0097690 A1 * 4/2012 Chien B65D 43/0212
 220/713
 2013/0140309 A1 * 6/2013 George A47G 19/2272
 220/254.1
 2013/0228586 A1 * 9/2013 Schandl B65D 45/22
 220/825
 2016/0264312 A1 * 9/2016 Choltco-Devlin
 B65D 47/0895
 2017/0208832 A1 * 7/2017 Erhart A23F 5/26
 2017/0225850 A1 * 8/2017 Sorensen B65D 47/0895
 2017/0253392 A1 * 9/2017 Bann B65D 43/22
 2017/0253396 A1 * 9/2017 Coon B65D 47/0866
 2017/0320643 A1 * 11/2017 Green B65D 51/005

OTHER PUBLICATIONS

Hydro Flask Lid: Announced Apr. 1, 2016 [online]. Site Visited
 [Apr. 16, 2018]. Available from Internet URL: <https://www.hydroflask.com/hydro-flip/color,black,a,92,o,20>.
 "Stanley Hydrate and Go Bottle," 1 page, Stanley product publicly
 disclosed prior to Apr. 6, 2017.

* cited by examiner

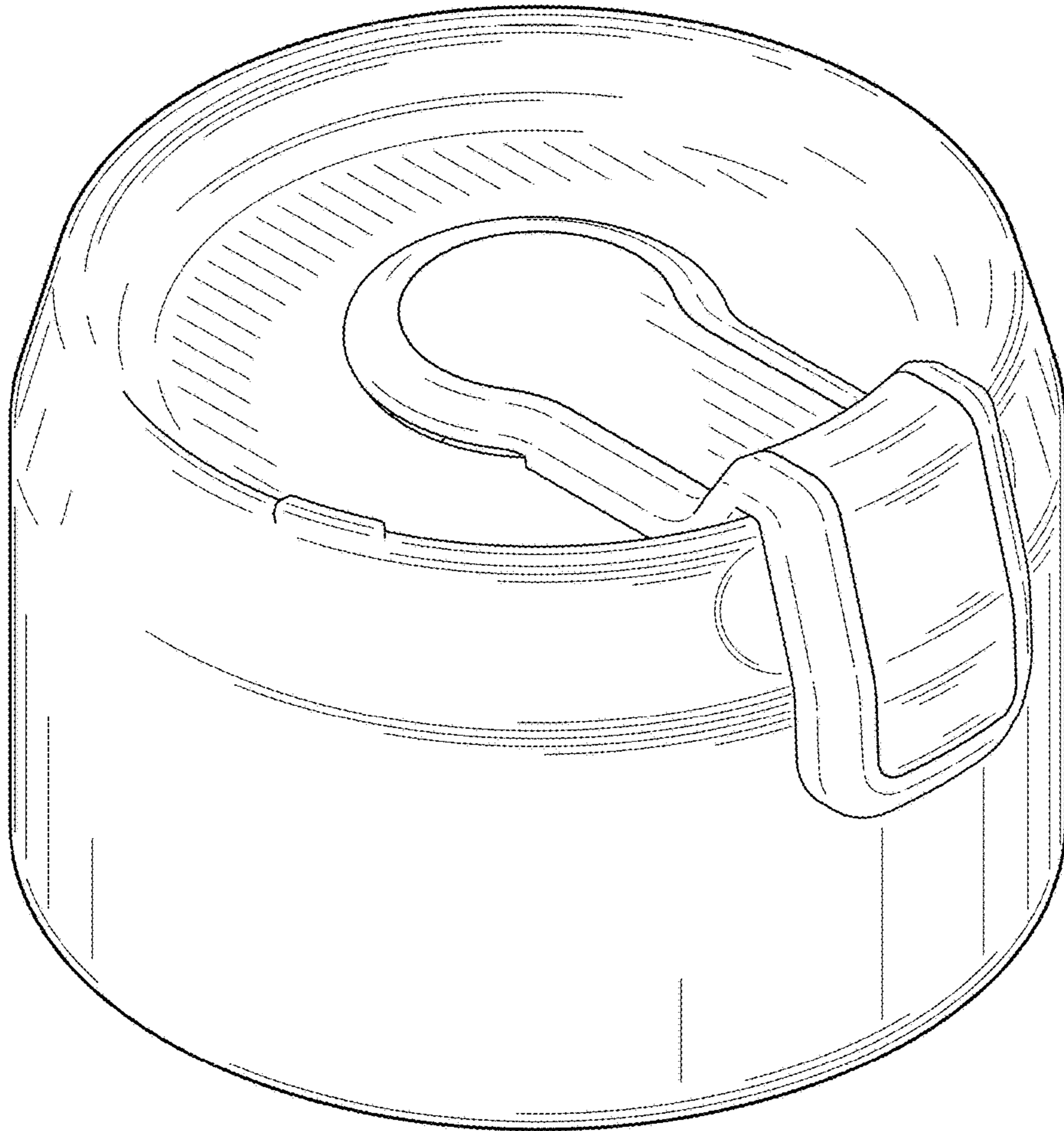

FIG. 1

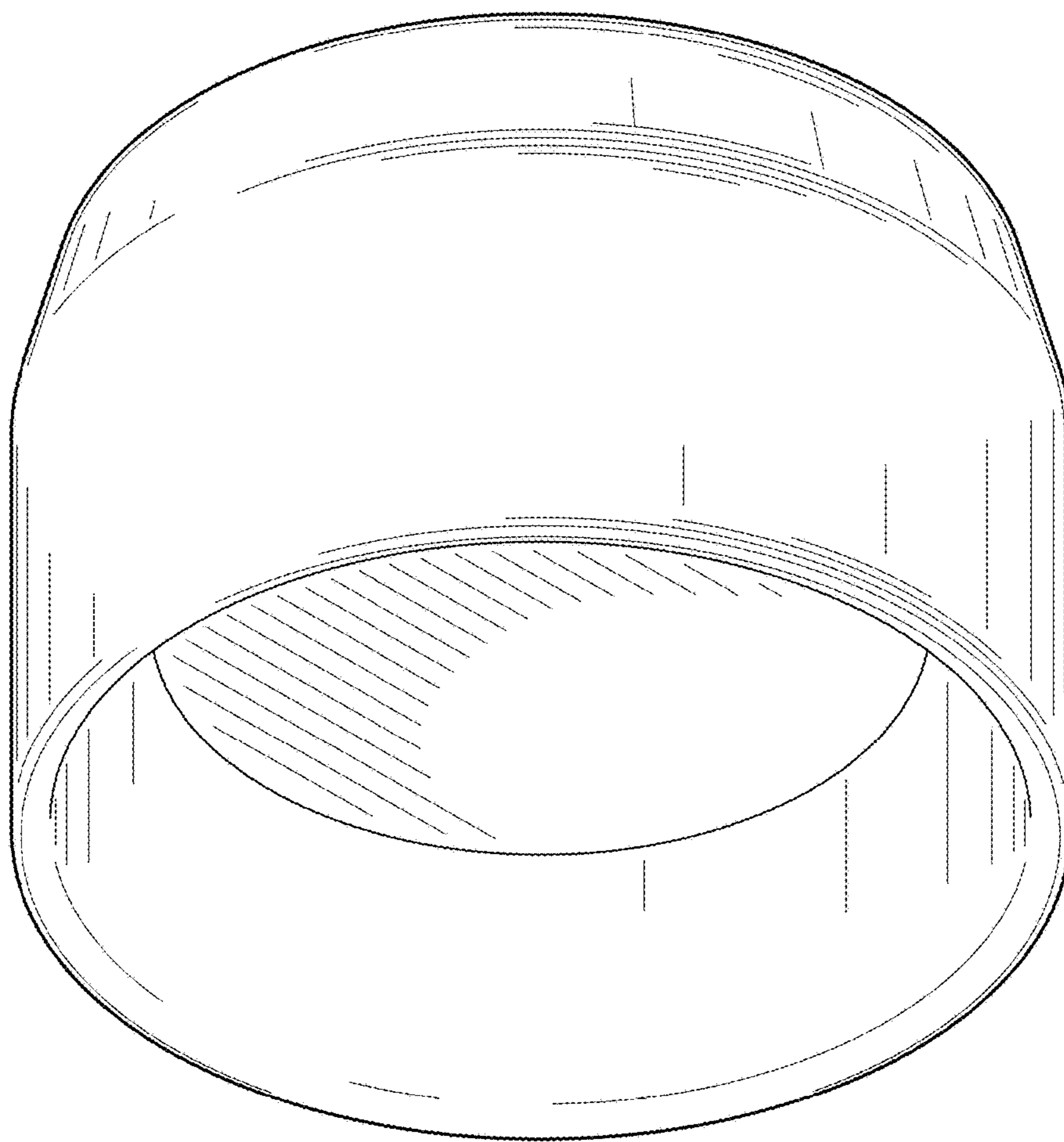

FIG. 2

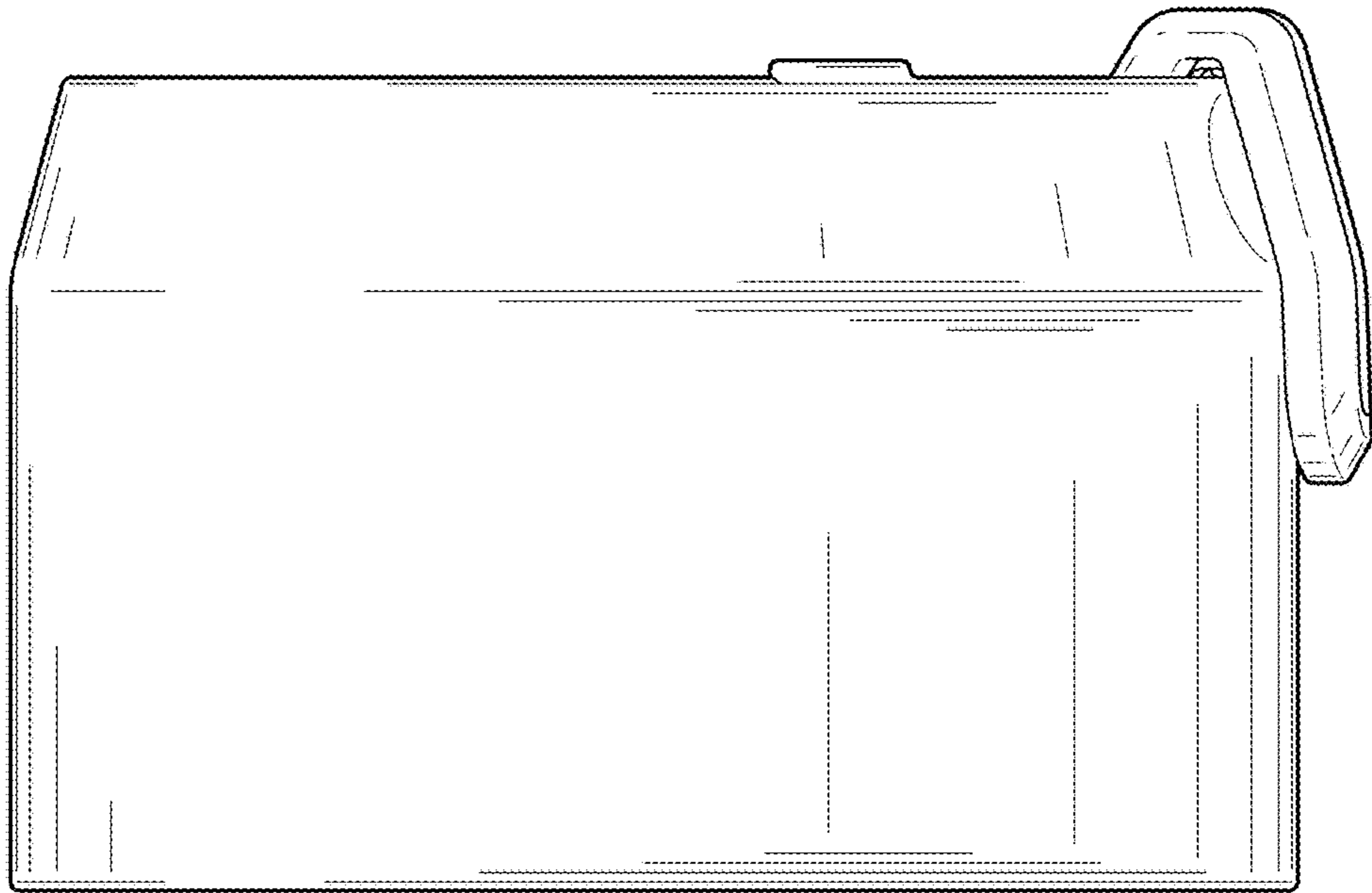

FIG. 3

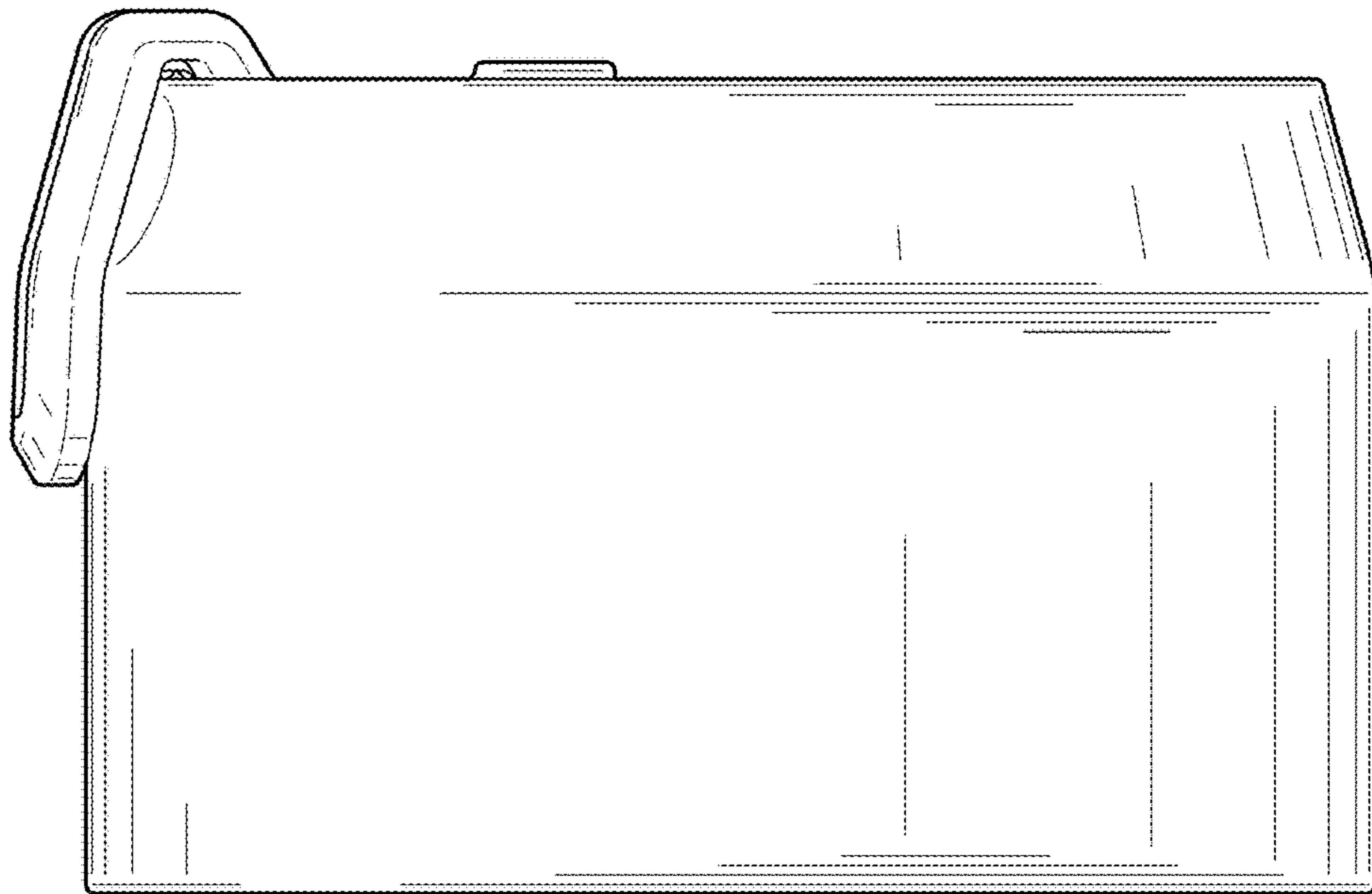

FIG. 4

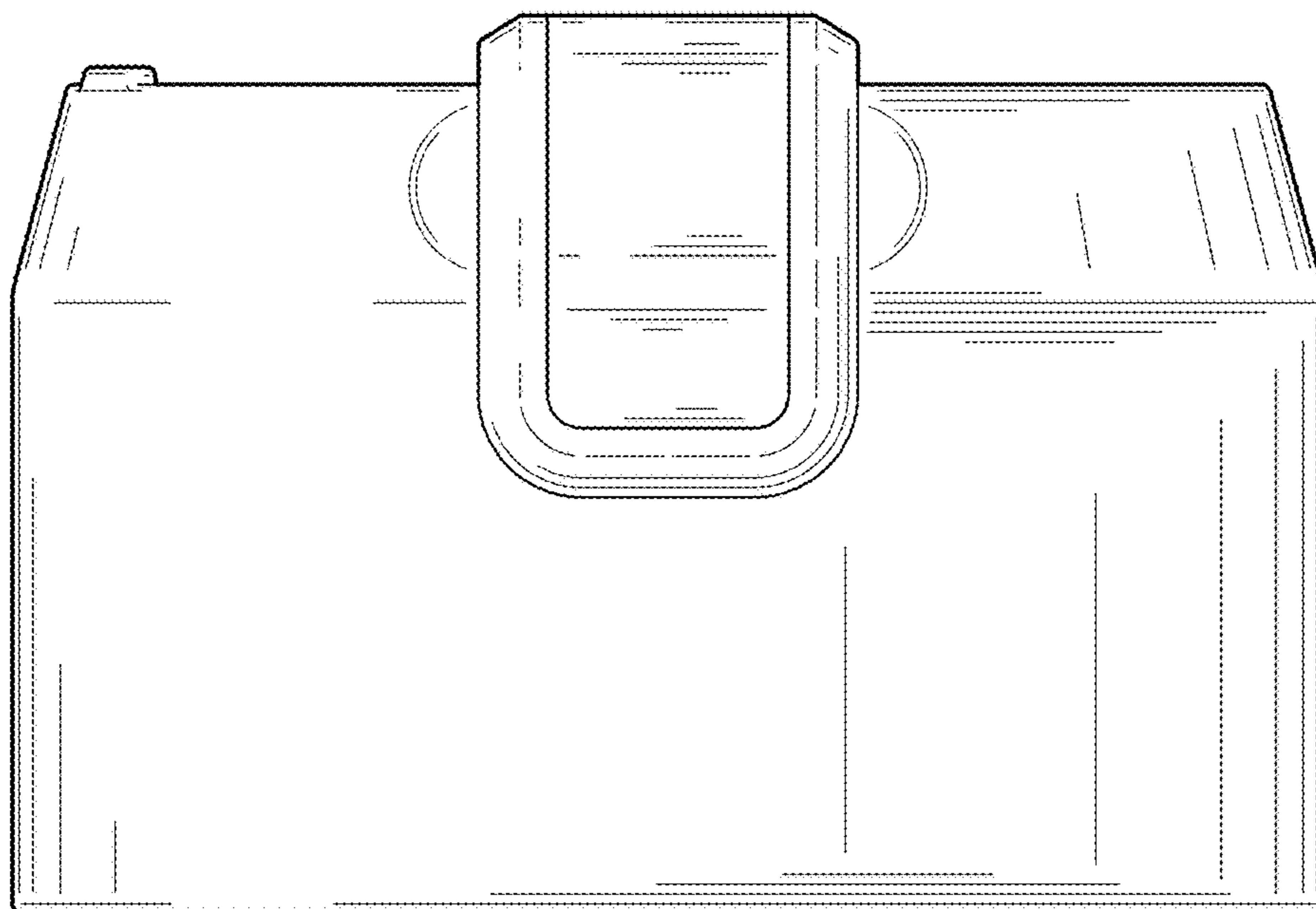

FIG. 5

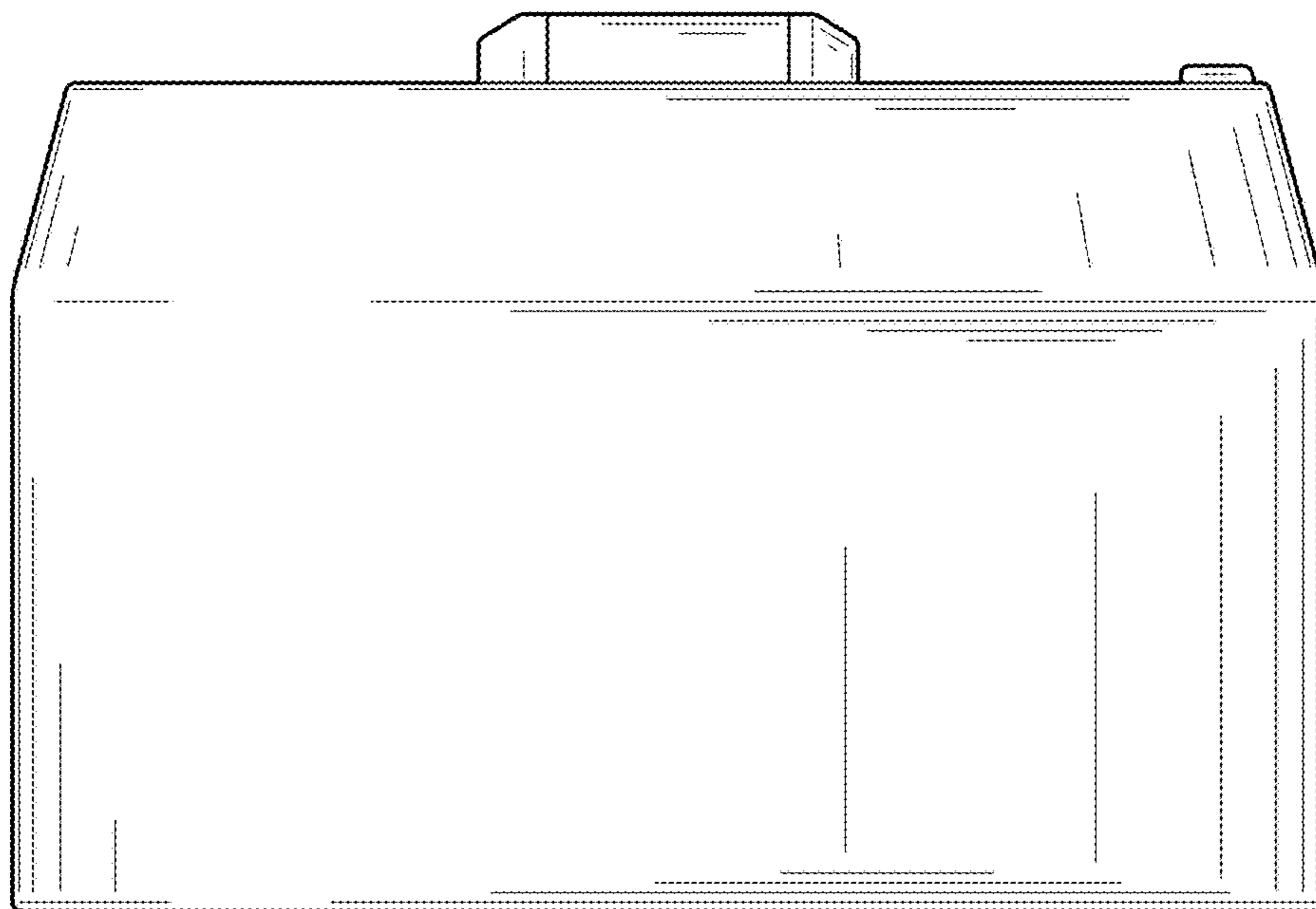

FIG. 6

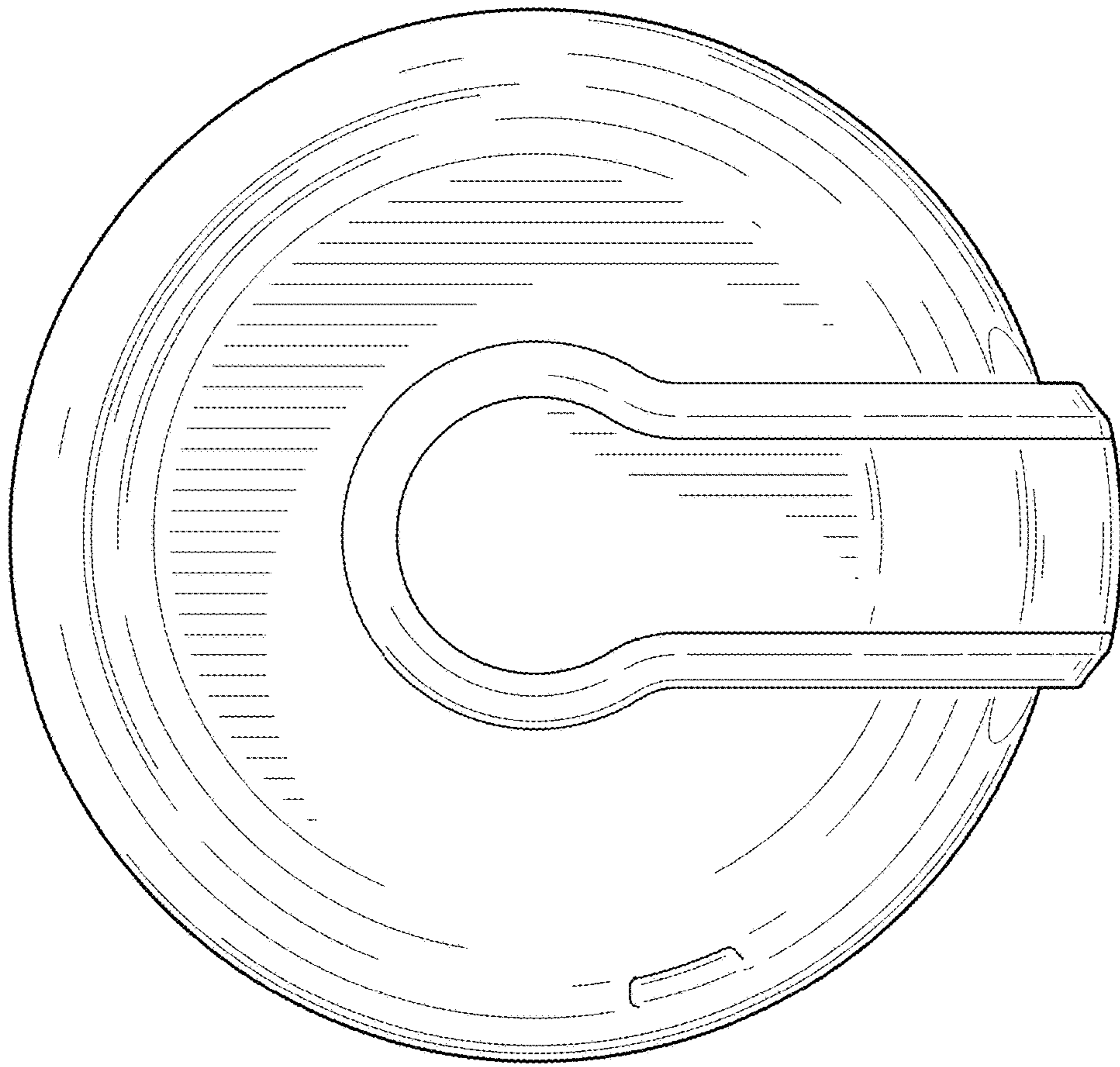

FIG. 7

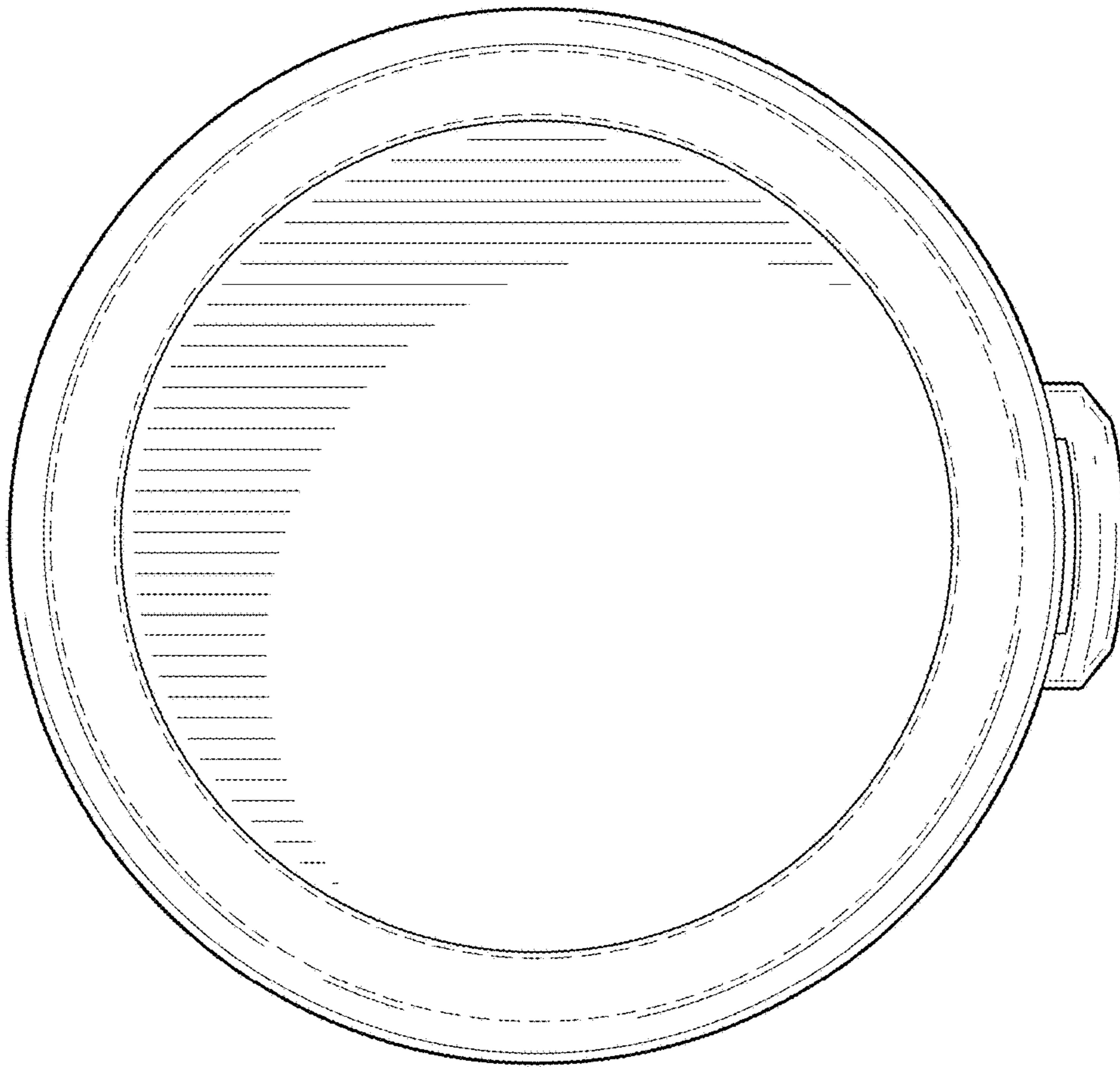

FIG. 8

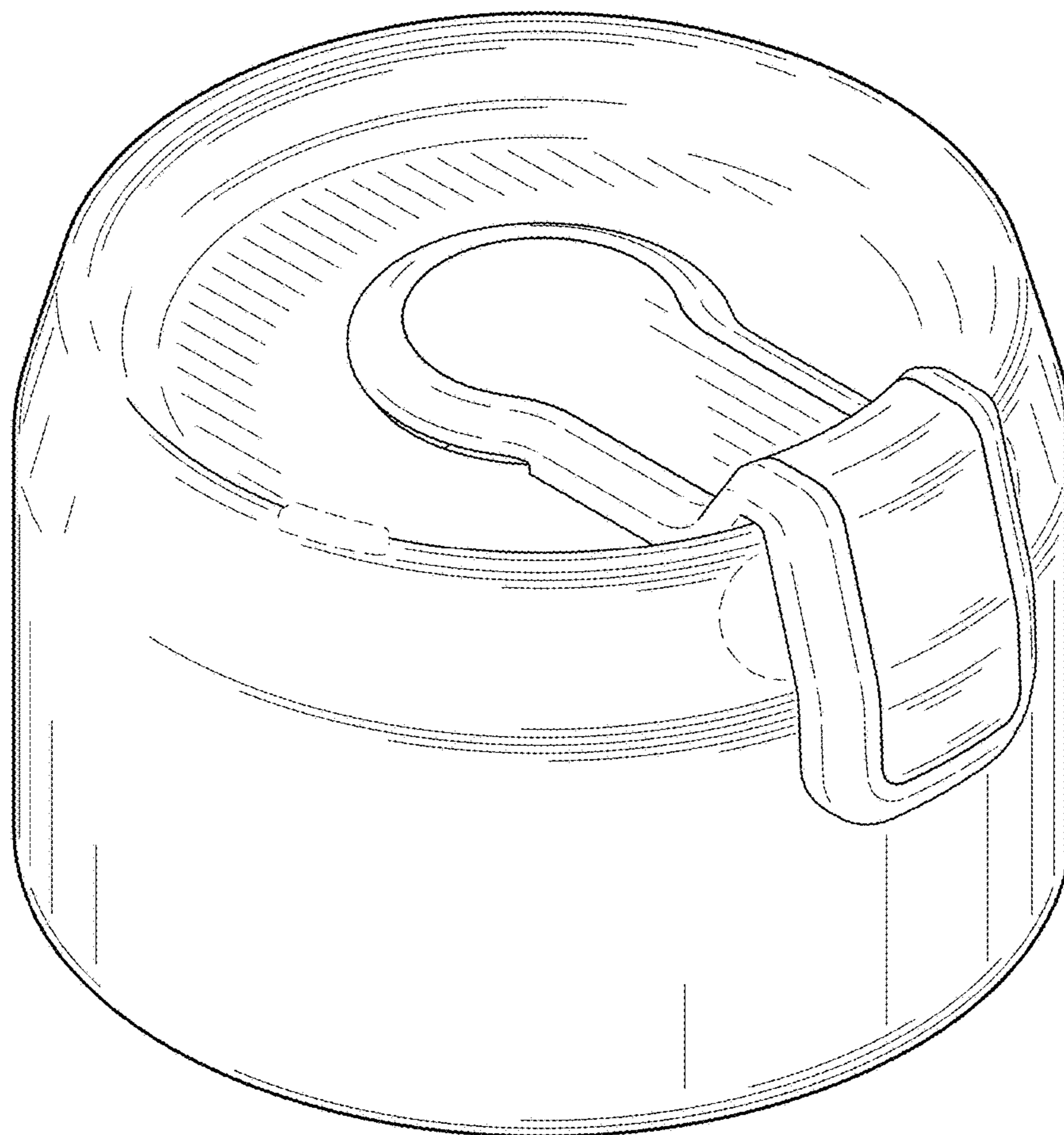

FIG. 9

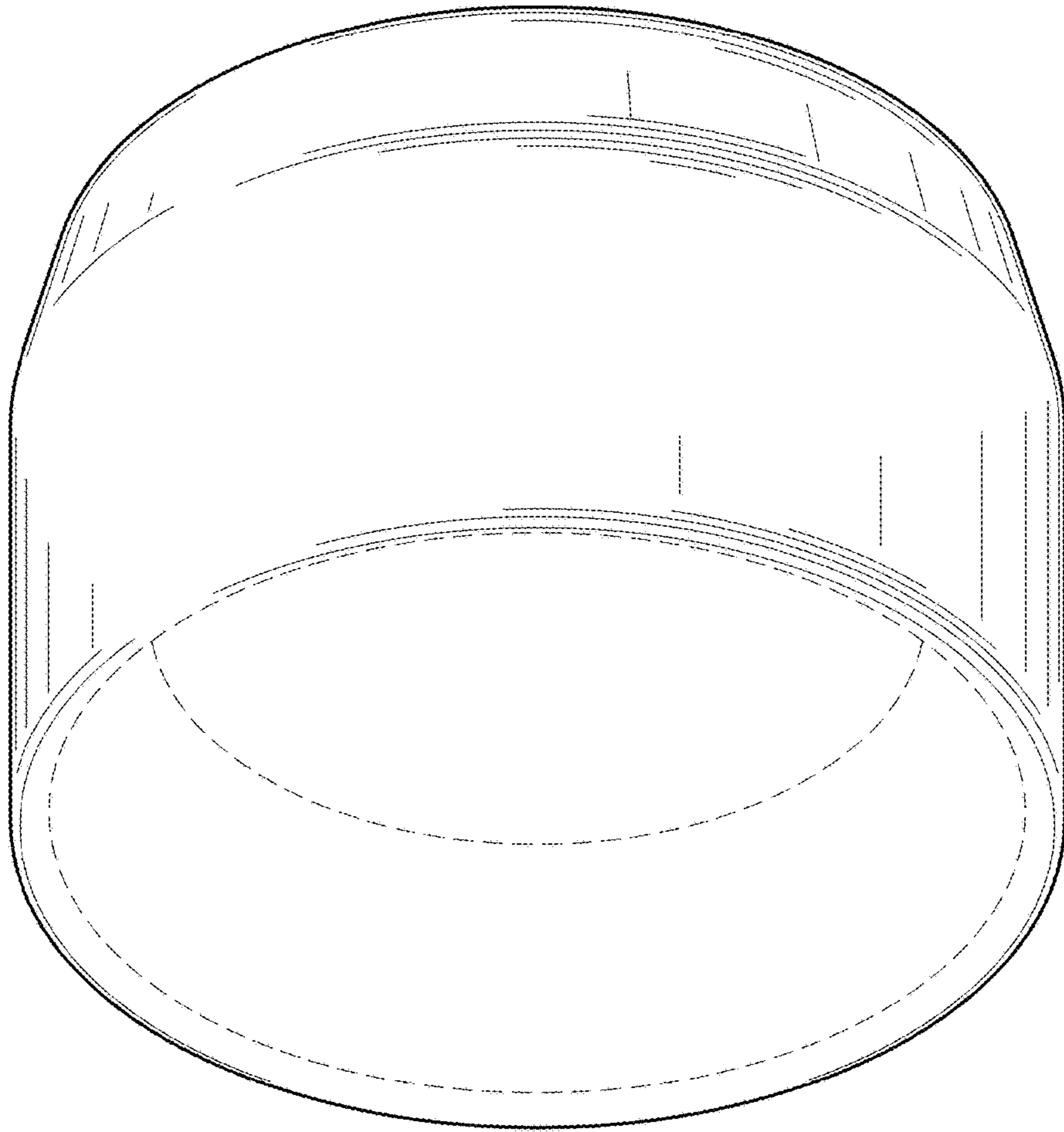

FIG. 10

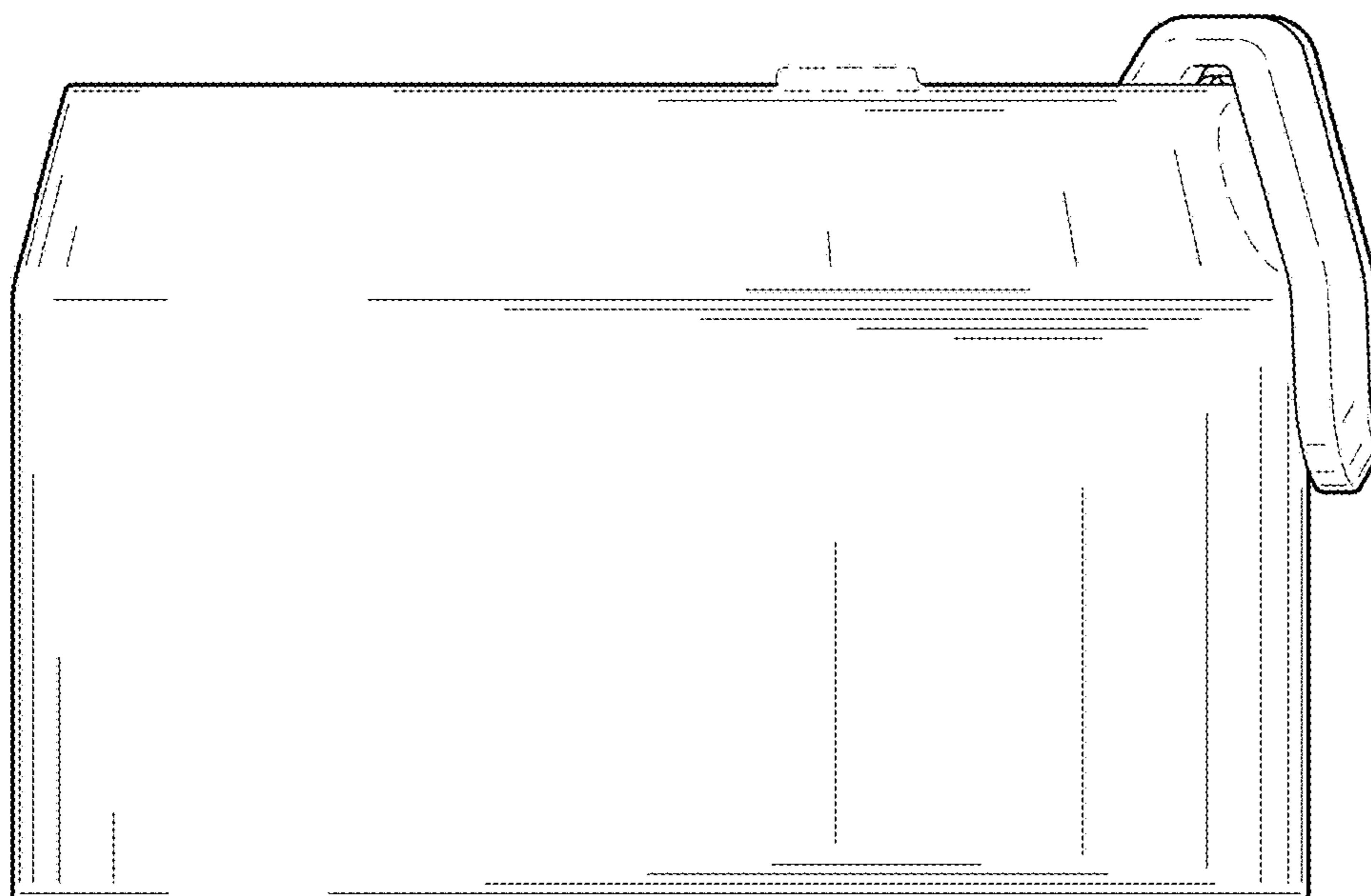

FIG. 11

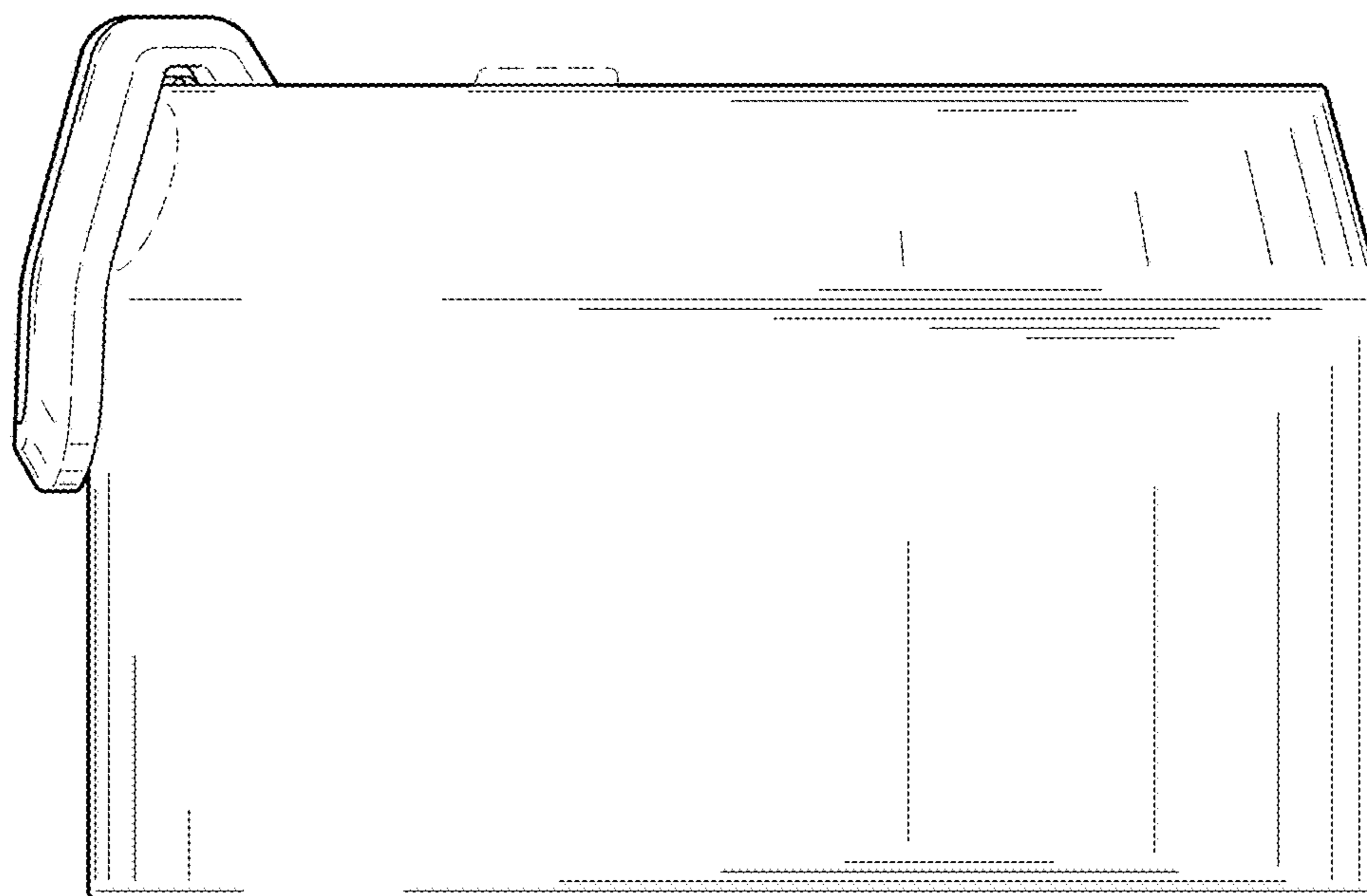

FIG. 12

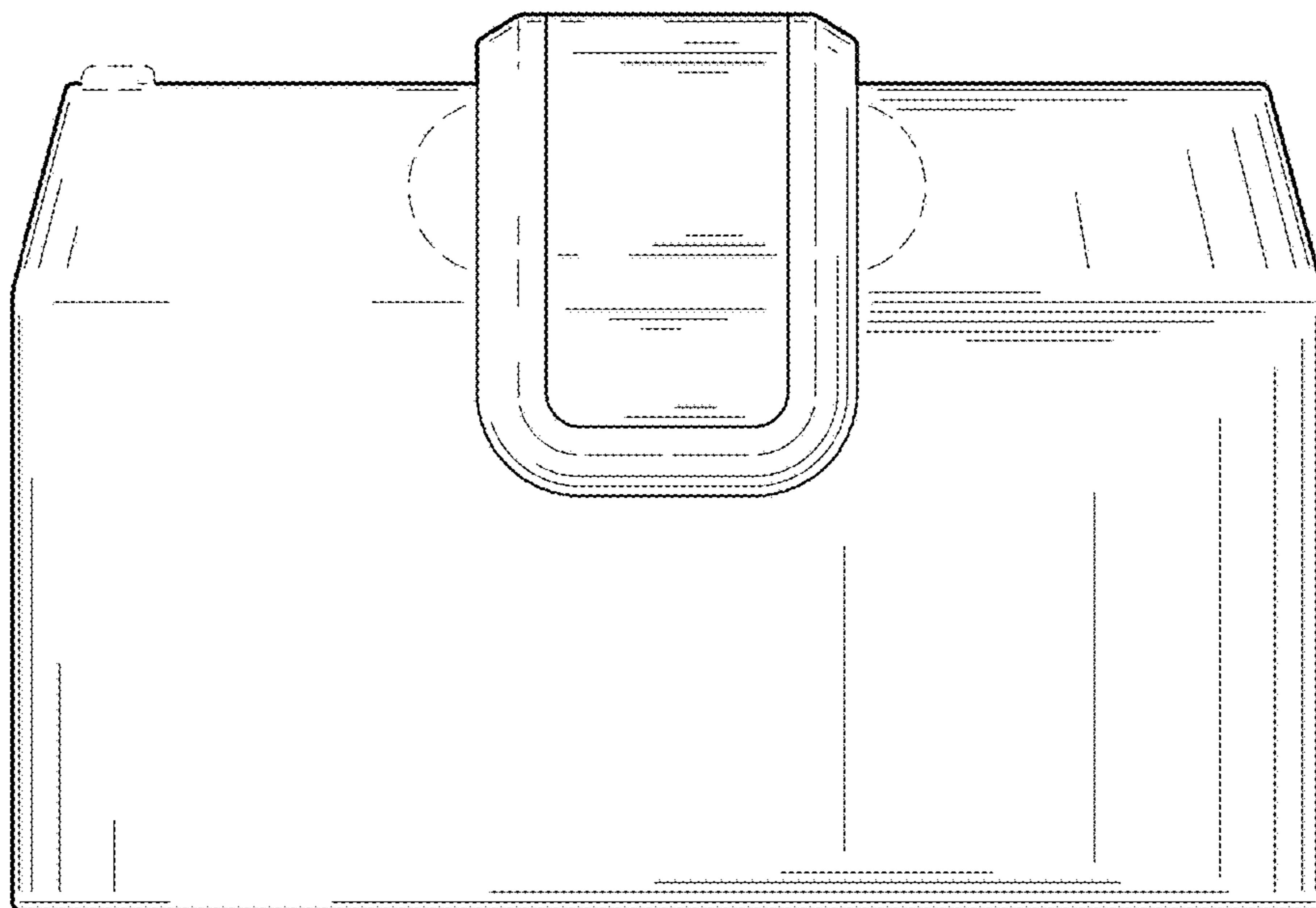

FIG. 13

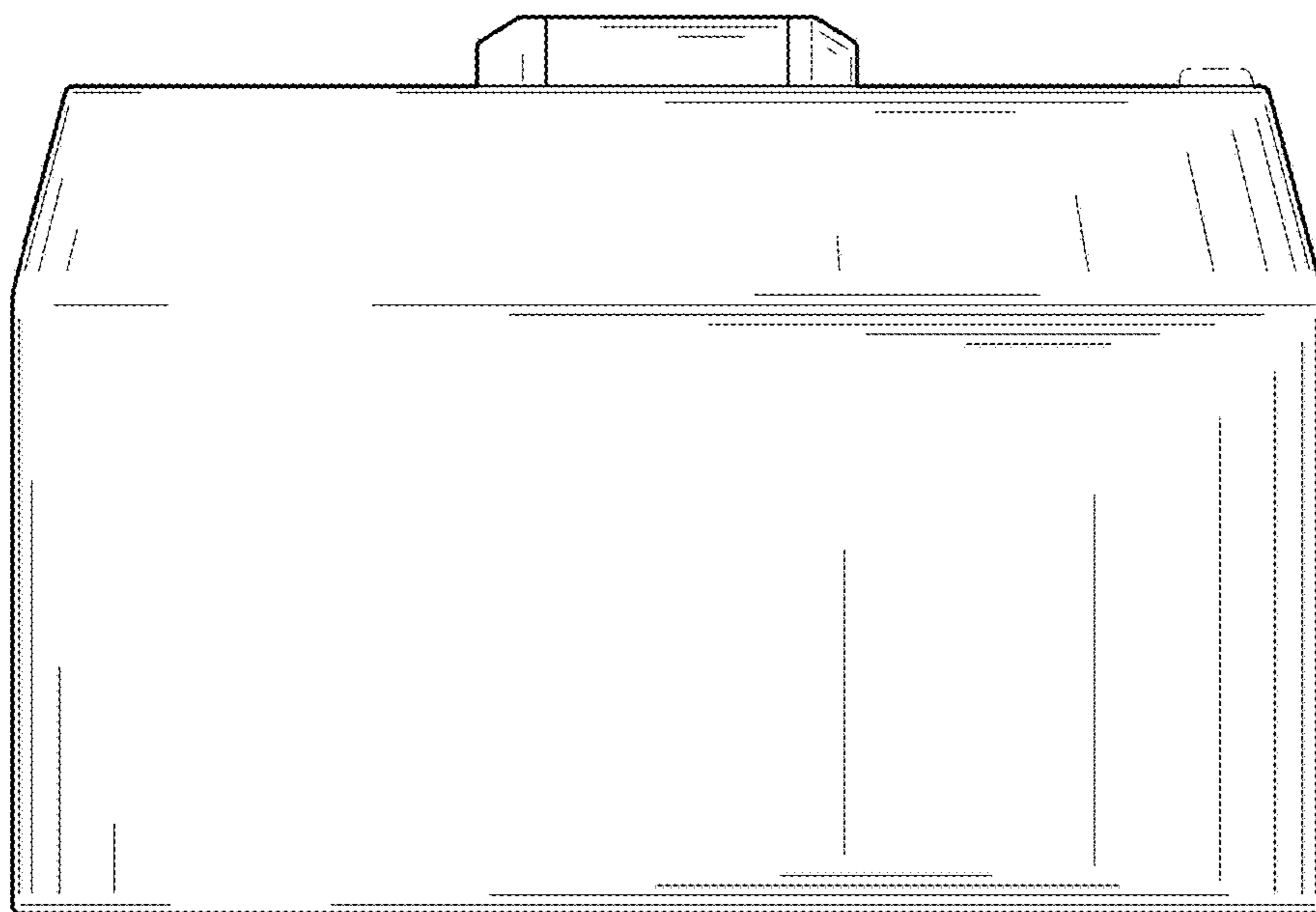

FIG. 14

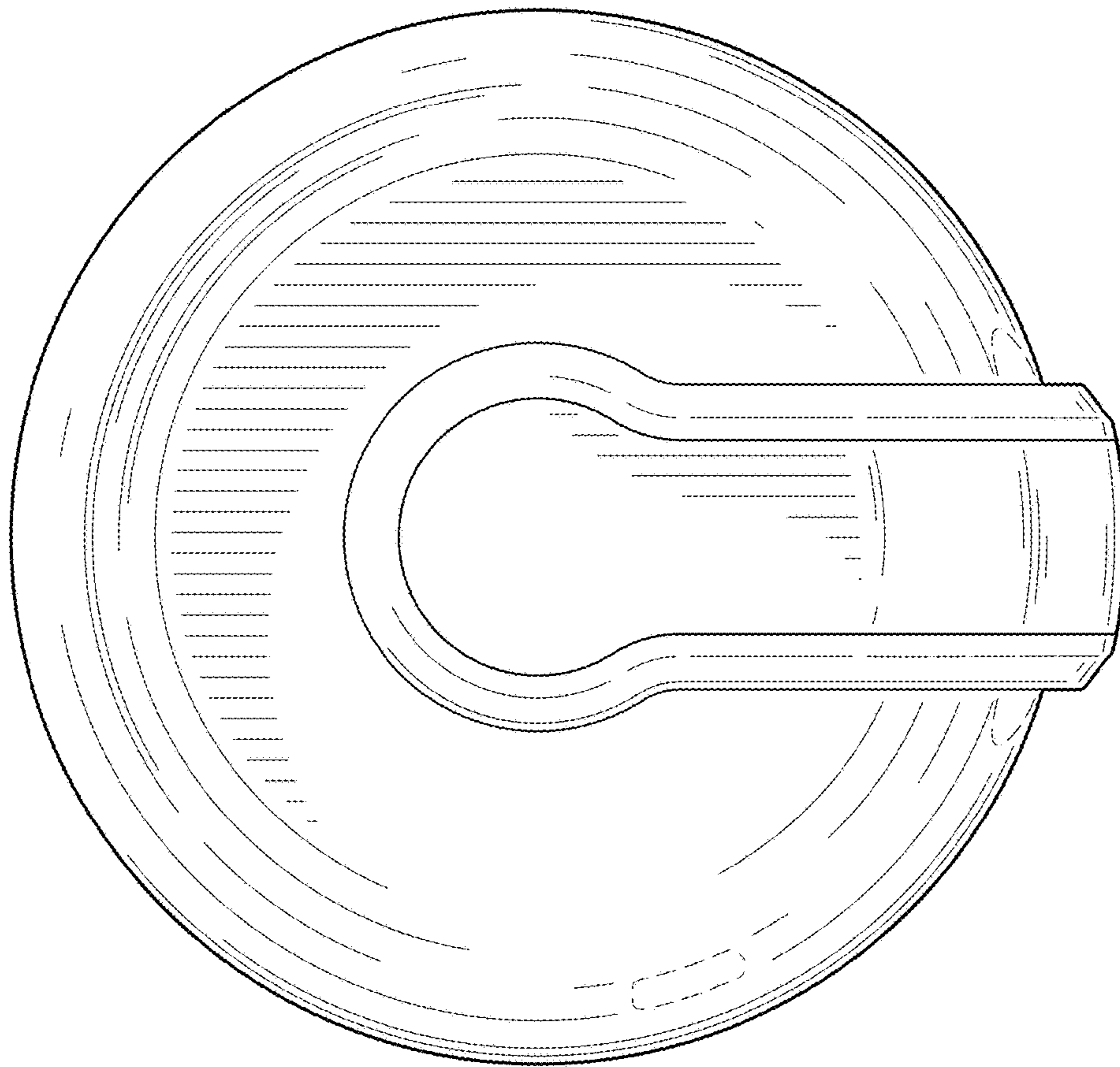

FIG. 15

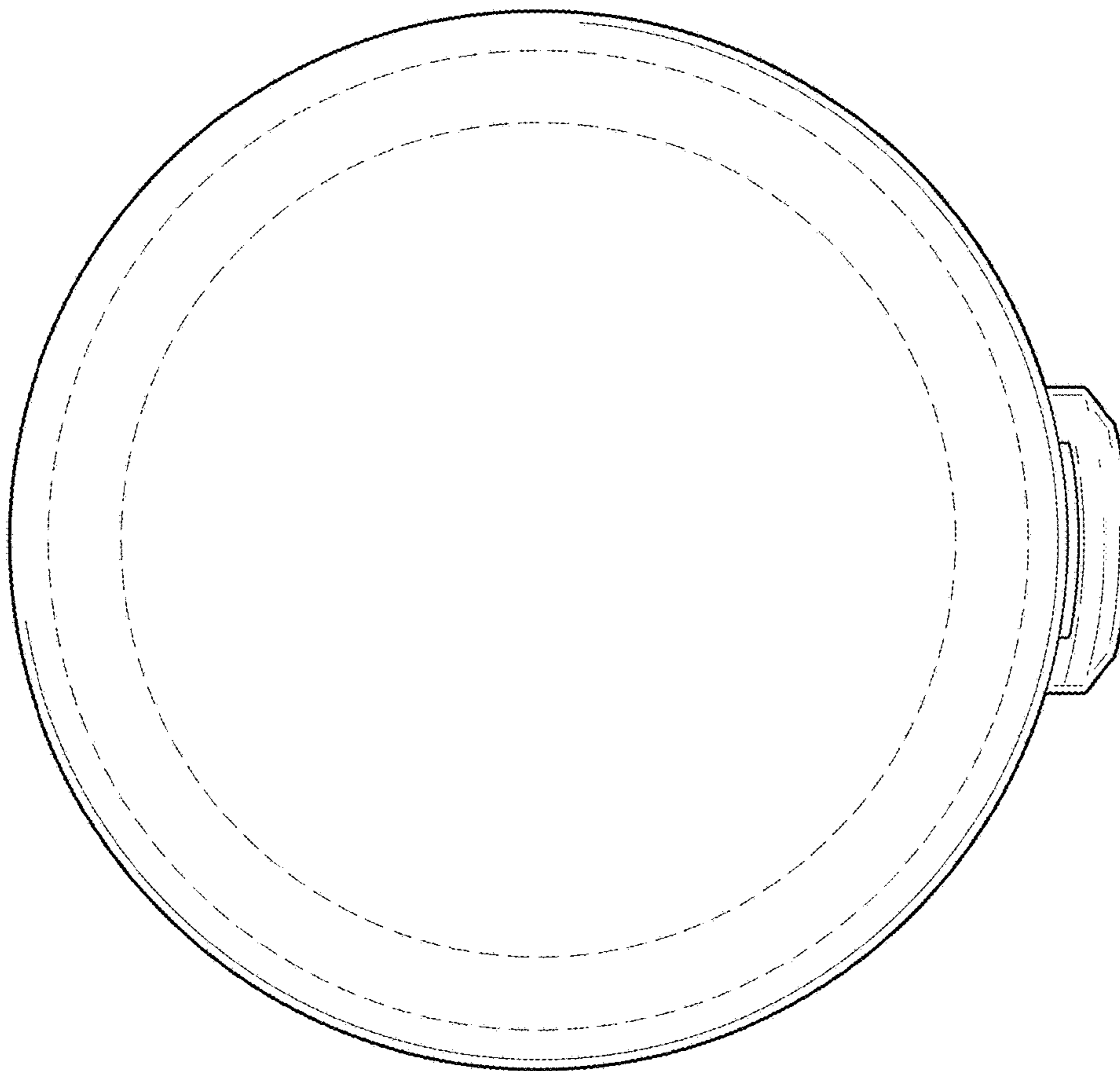

FIG. 16