



US00D851272S

(12) **United States Design Patent**
Huang

(10) **Patent No.:** **US D851,272 S**
(45) **Date of Patent:** **** Jun. 11, 2019**

(54) **NECK AND SHOULDER MASSAGER**

(71) Applicant: **ZYLLION, INC.**, Lake Forest, CA
(US)

(72) Inventor: **Hao-Chun Huang**, Taichung (TW)

(73) Assignee: **ZYLLION, INC.**, Lake Forest, CA
(US)

(**) Term: **15 Years**

(21) Appl. No.: **29/626,650**

(22) Filed: **Nov. 17, 2017**

(51) **LOC (11) Cl.** **28-03**

(52) **U.S. Cl.**
USPC **D24/215**

(58) **Field of Classification Search**
USPC D24/200, 211, 212, 213, 214, 215;
601/19, 22, 40, 46, 52, 63, 99, 110–113,
(Continued)

(56) **References Cited**

U.S. PATENT DOCUMENTS

5,143,057 A * 9/1992 DePasquale A61H 7/001
482/131
D389,584 S * 1/1998 Leventhal D24/200
(Continued)

OTHER PUBLICATIONS

Inerzen Shiatsu Neck Shoulder and Back Body Kneading Massager with Heat—Arm Straps, Portable, Lightweight, Inerzen, retrieved from the Internet at least as early as Jan. 10, 2018, <URL: https://www.amazon.com/Inerzen-Shiatsu-Shoulder-Kneading-Massager/dp/B011FKF5ZG/ref=sr_1_7_a_it?ie=UTF8&qid=1514589754&sr=8-7&keywords=massager+with+strap>.

(Continued)

Primary Examiner — Sandra S Snapp

(74) *Attorney, Agent, or Firm* — Klein, O’Neill & Singh, LLP

(57) **CLAIM**

The ornamental design for a neck and shoulder massager, as shown and described.

DESCRIPTION

FIG. 1 is a perspective view of a first embodiment of a neck and shoulder massager with the neck massager shown in phantom;

FIG. 2 is a front view of the neck and shoulder massager shown in FIG. 1;

FIG. 3 is a back view of the neck and shoulder massager shown in FIG. 1;

FIG. 4 is a left view of the neck and shoulder massager shown in FIG. 1;

FIG. 5 is a right view of the neck and shoulder massager shown in FIG. 1;

FIG. 6 is a top view of the neck and shoulder massager shown in FIG. 1;

FIG. 7 is a bottom view of the neck and shoulder massager shown in FIG. 1;

FIG. 8 is a perspective view of a second embodiment of the neck and shoulder massager;

FIG. 9 is a front view of the neck and shoulder massager shown in FIG. 8;

FIG. 10 is a back view of the neck and shoulder massager shown in FIG. 8;

FIG. 11 is a left view of the neck and shoulder massager shown in FIG. 8;

FIG. 12 is a right view of the neck and shoulder massager shown in FIG. 8;

FIG. 13 is a top view of the neck and shoulder massager shown in FIG. 8; and,

FIG. 14 is a bottom view of the neck and shoulder massager shown in FIG. 8.

The broken lines depict portions of the neck and shoulder massager and form no part of the claimed design.

1 Claim, 14 Drawing Sheets

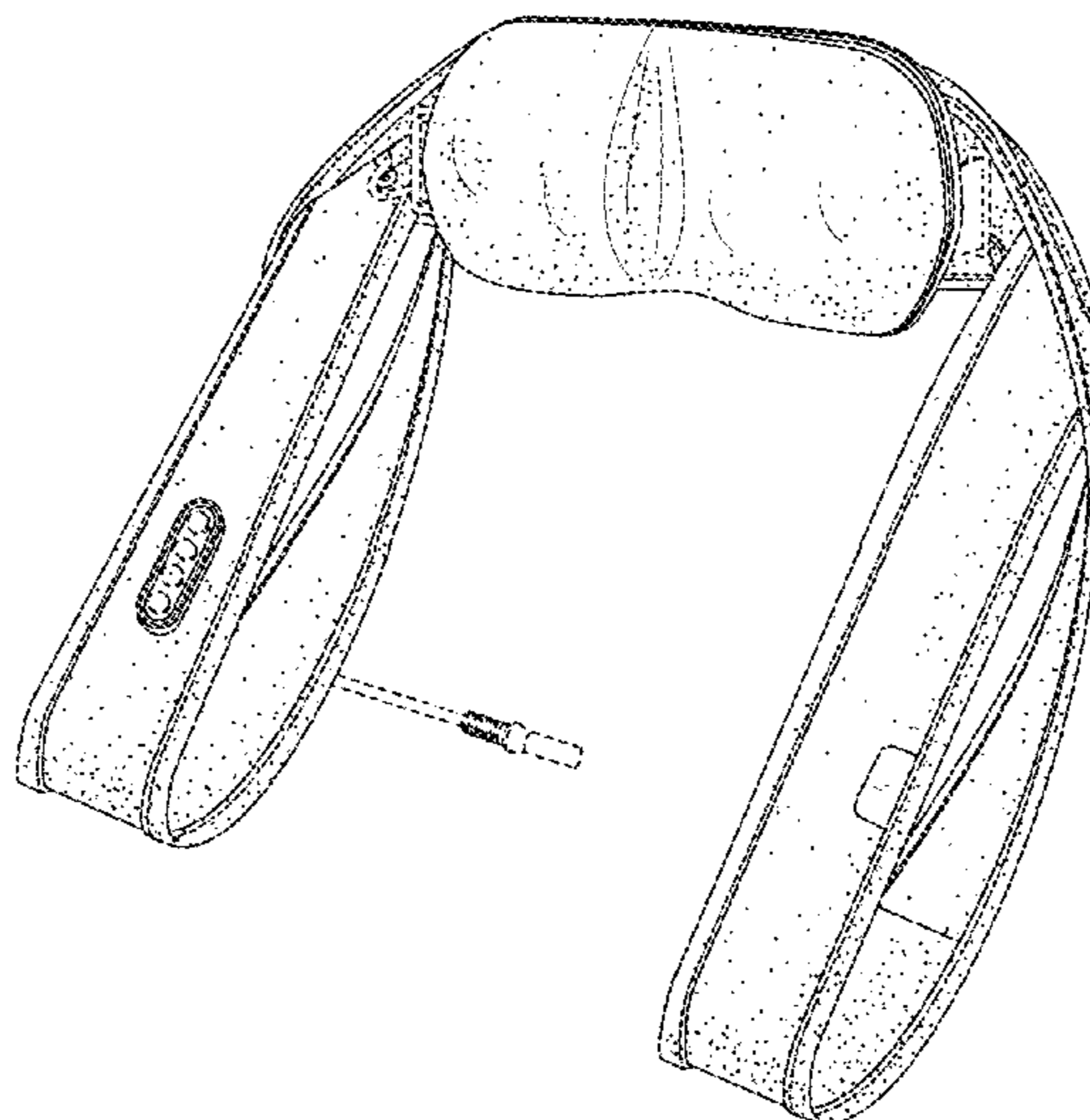

(58) **Field of Classification Search**

USPC 601/118-120, 125, DIG. 12, DIG. 14,
601/DIG. 15, DIG. 16, DIG. 17
CPC A61H 1/00; A61H 2015/0007; A61H
2015/0014; A61H 2015/0042; A61H
15/00; A61H 11/00; A61H 21/00; A61H
37/00

See application file for complete search history.

D817,508 S * 5/2018 Gan D24/215
D818,596 S * 5/2018 Zheng D24/200
9,958,275 B2 * 5/2018 Chelian H04B 1/385
10,012,505 B2 * 7/2018 Dayal G06F 17/30
2009/0118652 A1 * 5/2009 Carlucci A61H 7/007
601/134

OTHER PUBLICATIONS

(56)

References Cited

U.S. PATENT DOCUMENTS

6,699,271 B2 * 3/2004 Clayton A61F 7/02
607/109
D517,217 S * 3/2006 Zou D24/215
D609,818 S * 2/2010 Tsang D24/215
D625,427 S * 10/2010 Lee D24/214
D649,655 S * 11/2011 Petersen D24/215
D674,501 S * 1/2013 Petersen D24/215
D705,436 S * 5/2014 Chen D24/215
D768,024 S * 10/2016 Dayal D10/65
9,629,774 B2 * 4/2017 Dayal G01C 21/206
9,677,901 B2 * 6/2017 Yamamoto G01C 21/3655
9,898,039 B2 * 2/2018 Moore A61B 5/02438
D812,238 S * 3/2018 Ho D24/200
D816,858 S * 5/2018 Gan D24/215

Nursal Cordless Shoulder Massager Shiatsu Massage with Heat for Neck, Waist and Back, Longer Straps and Rechargeable Battery, Deep-Kneading for Travel Home Office Use, Nursal, retrieved from the Internet at least as early as Jan. 10, 2018, <URL:https://www.amazon.com/NURSAL-Cordless-Shoulder-Rechargeable-Deep-Kneading/dp/B074W87M9V/ref=sr_1_3_a_it?ie=UTF8&qid=1514589754&sr=8-3&keywords=massager+with+strap>.
Shiatsu Shoulder and Neck Massager with Heat, Augymer Back Massager Kneading Massage for Office Car Home Muscles Pain Relieve, Augymer, retrieved from the Internet at least as early as Jan. 10, 2018, <URL:https://www.amazon.com/AUGYMER-Shoulder-Shiatsu-Massager-Kneading/dp/B01J7L899Q/ref=sr_1_9_a_it?ie=UTF8&qid=1514589754&sr=8-9&keywords=massager+with+strap>.

* cited by examiner

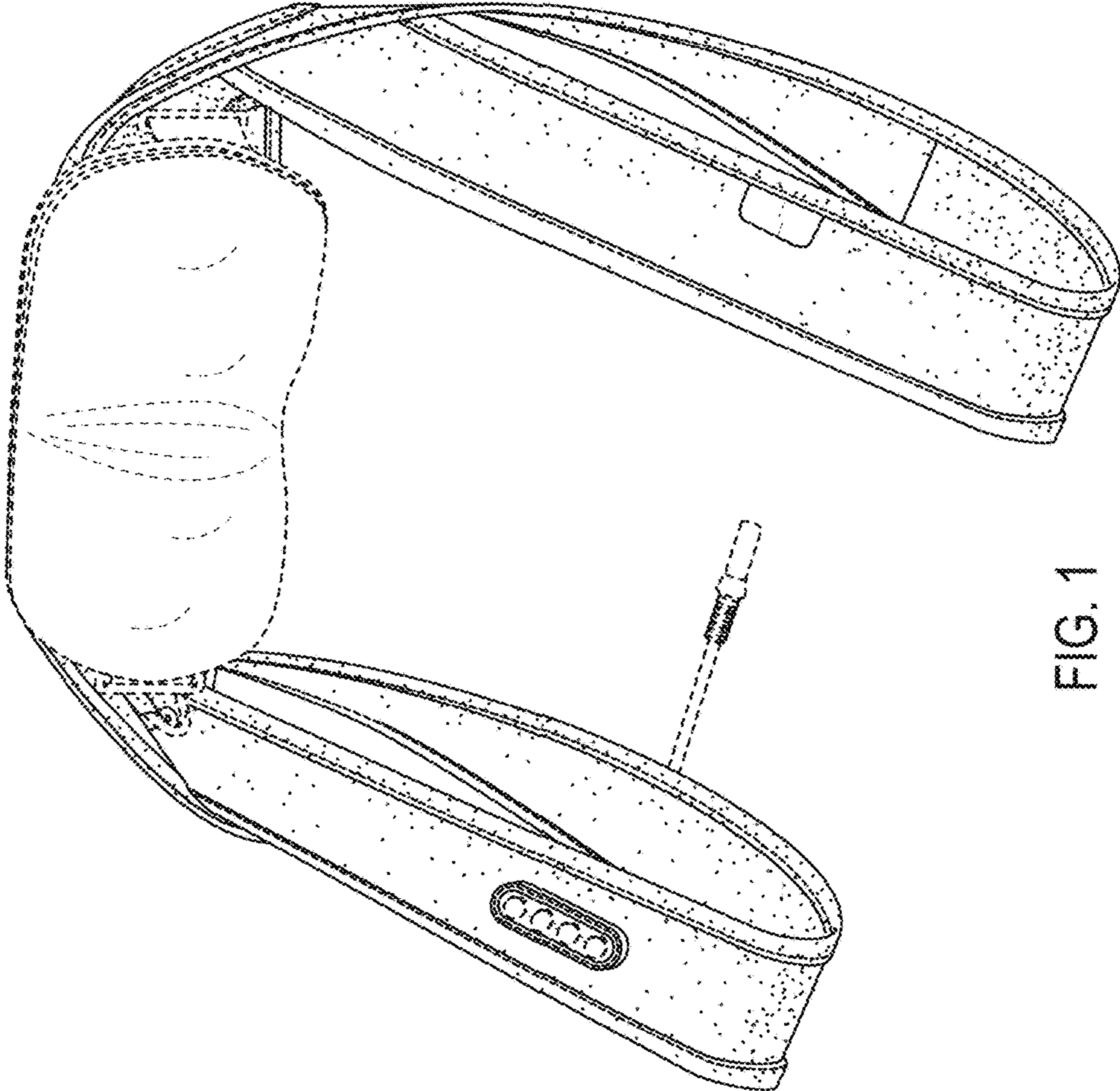

FIG. 1

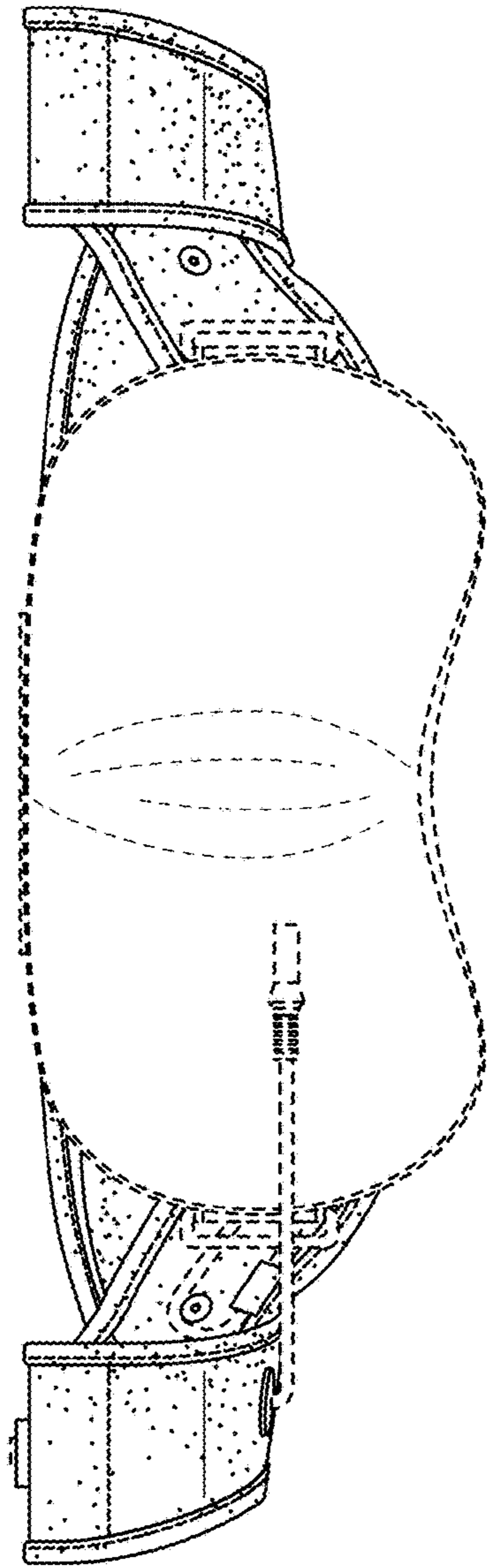

FIG. 2

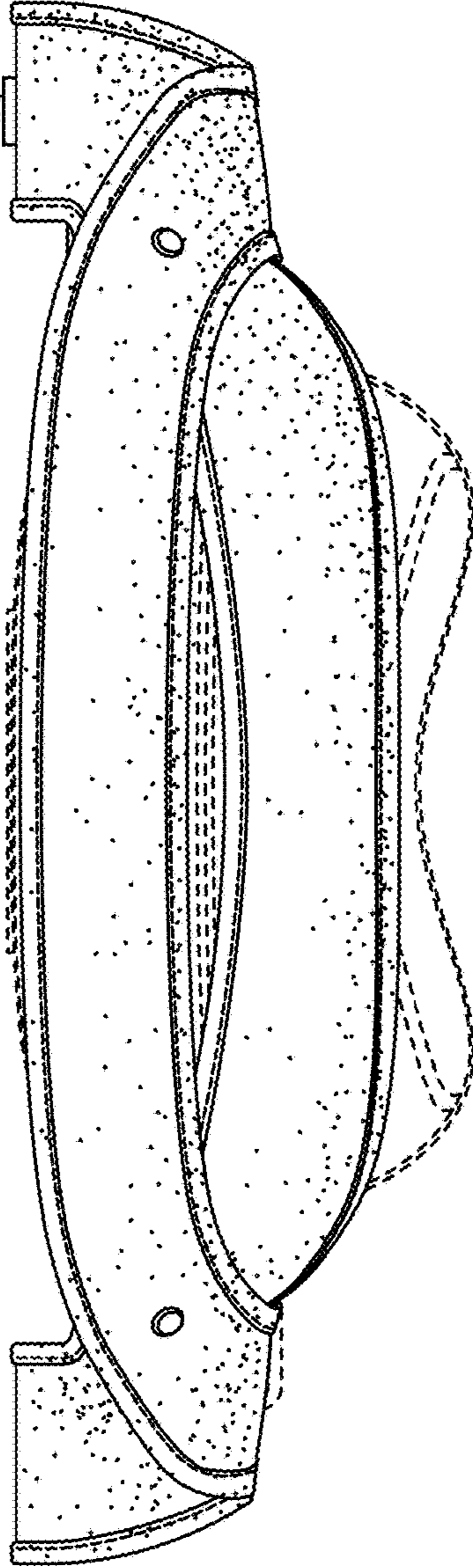

FIG. 3

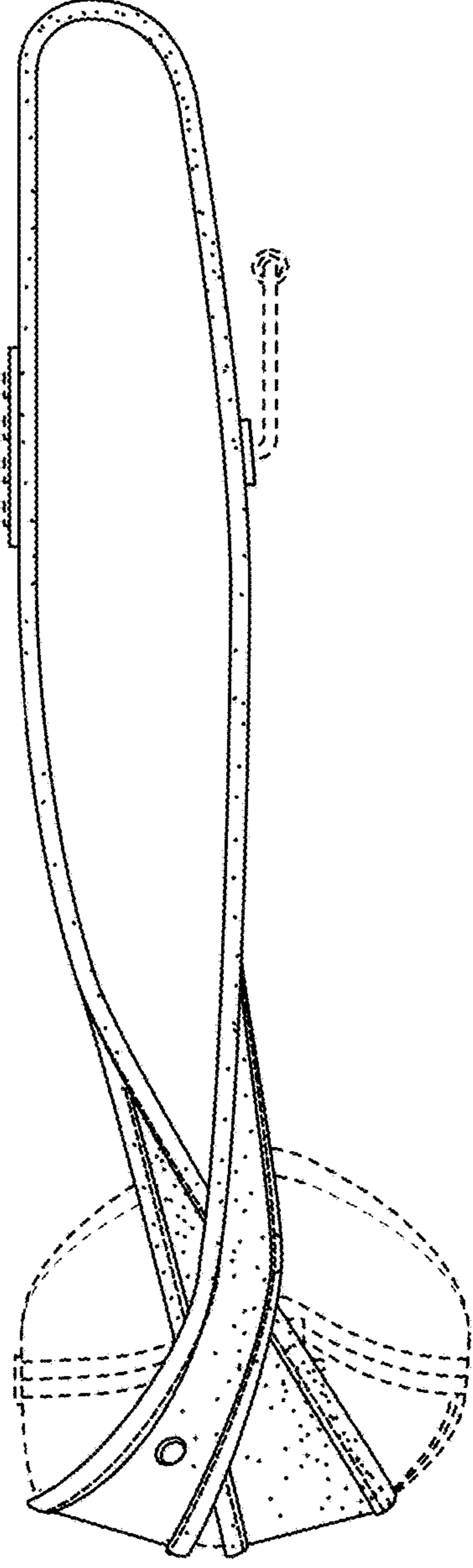

FIG. 4

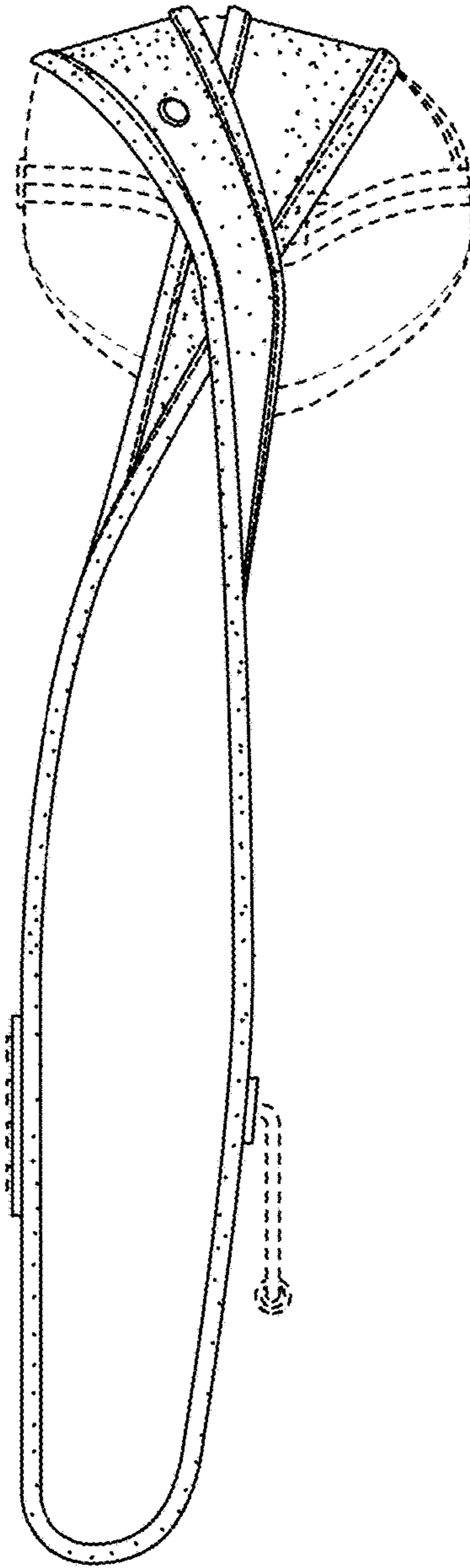

FIG. 5

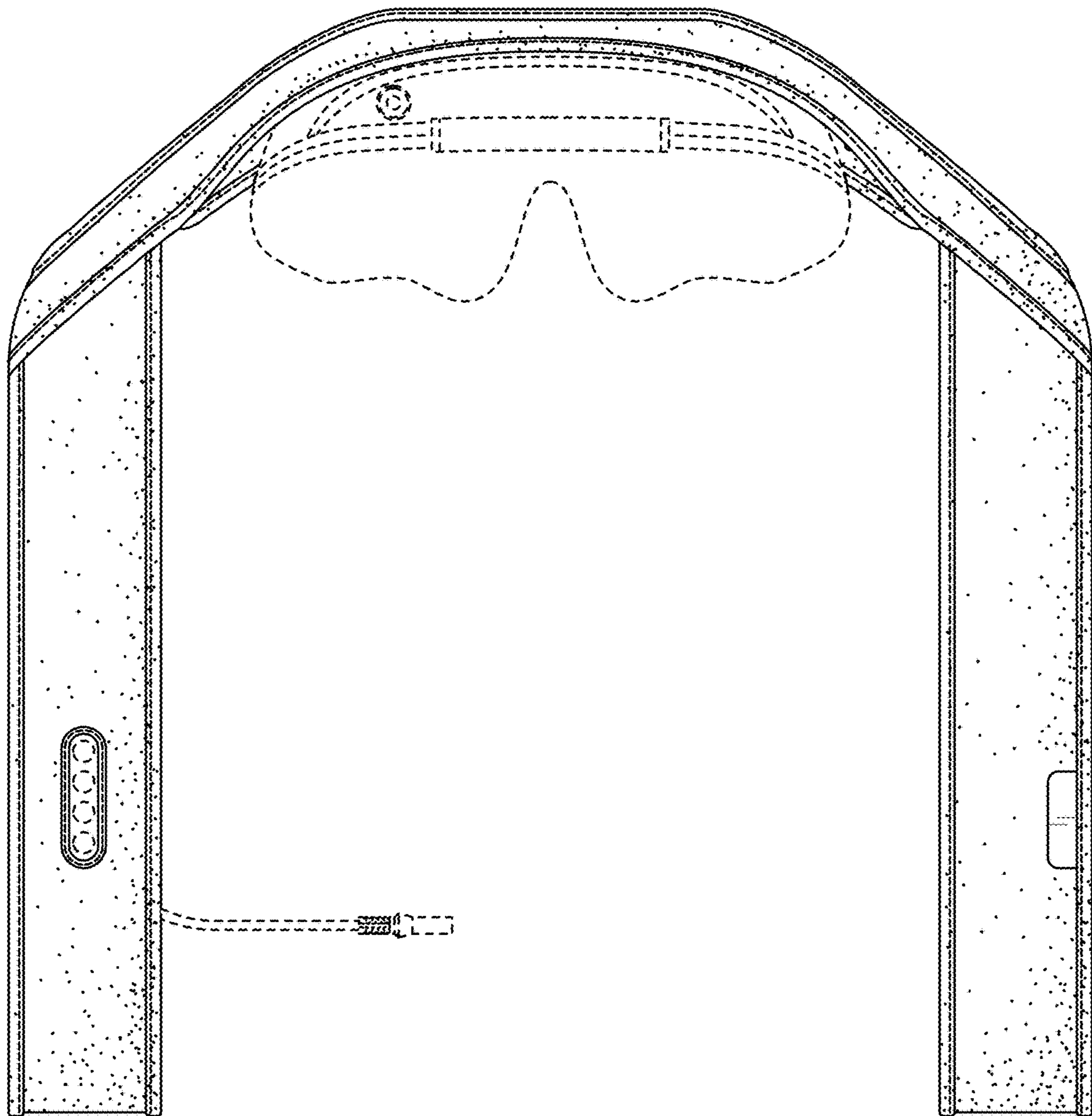

FIG. 6

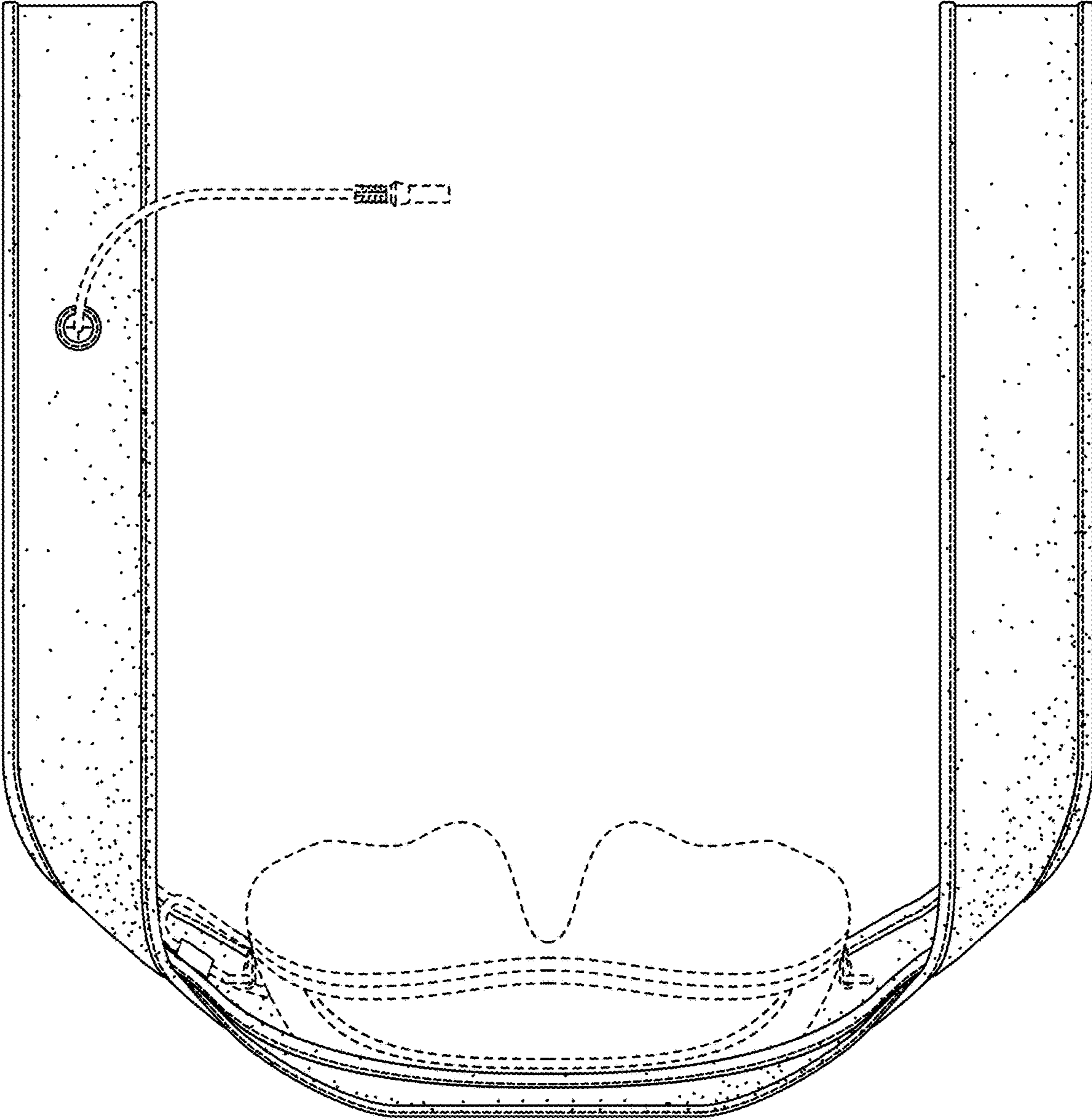

FIG. 7

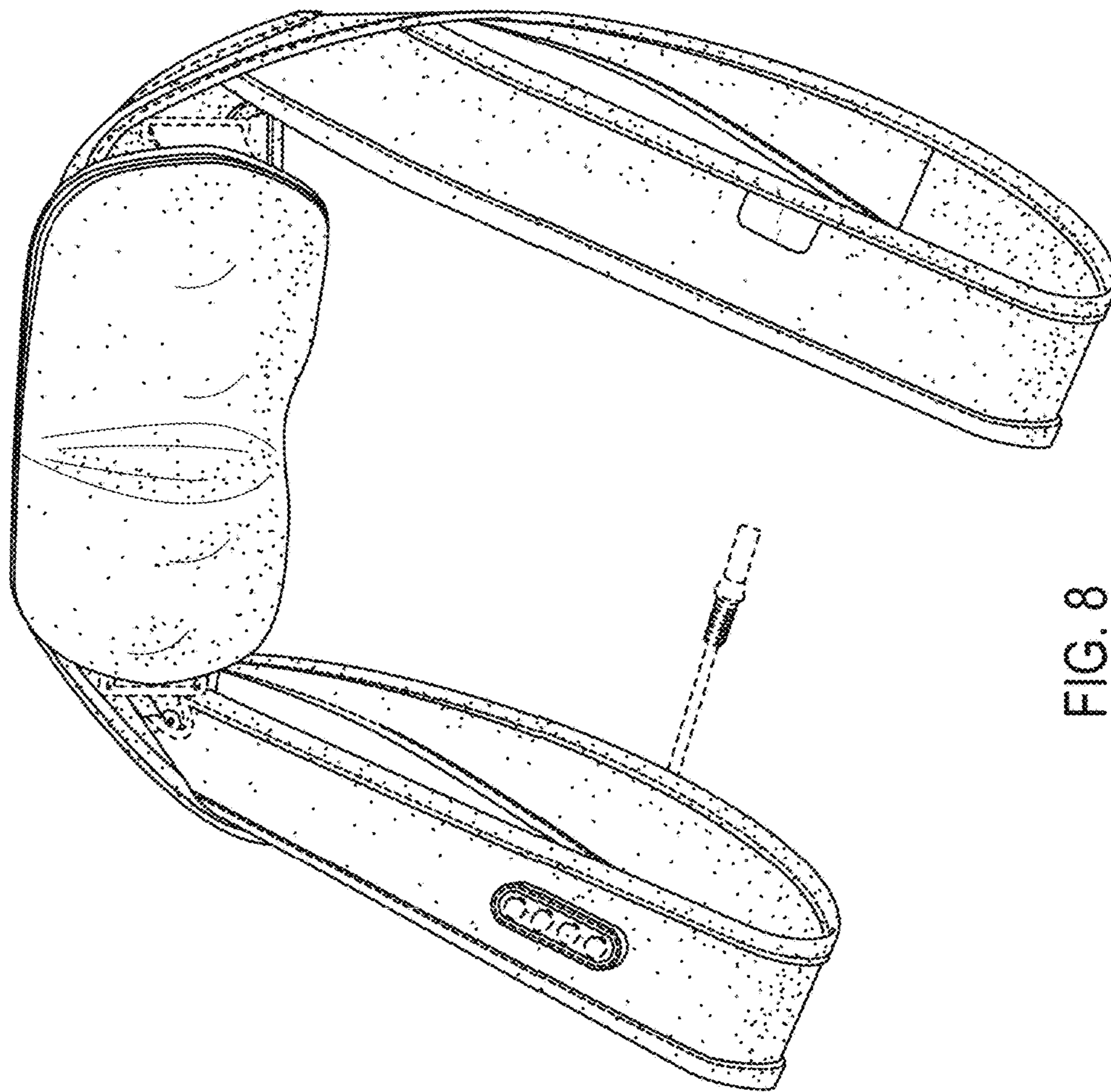

FIG. 8

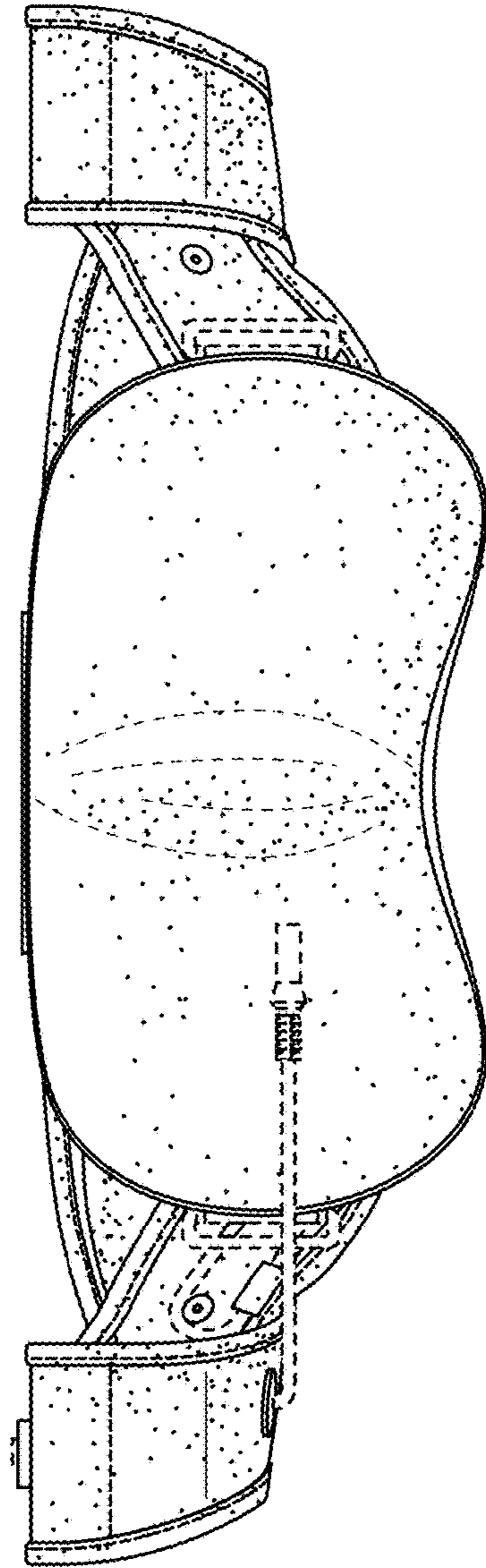

FIG. 9

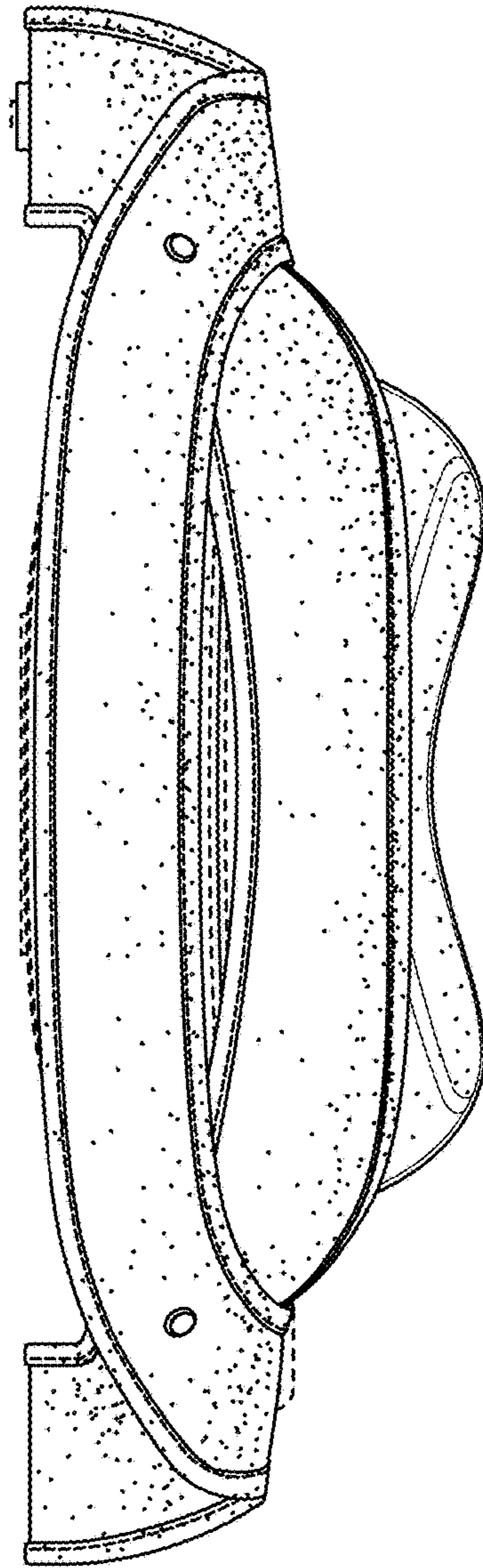

FIG. 10

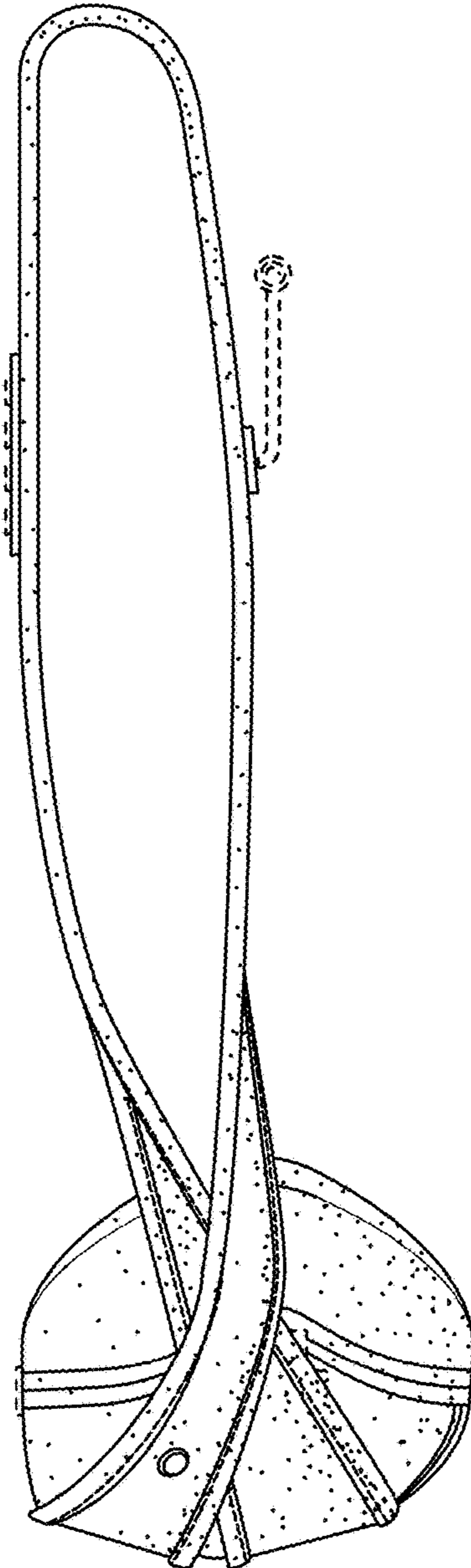

FIG. 11

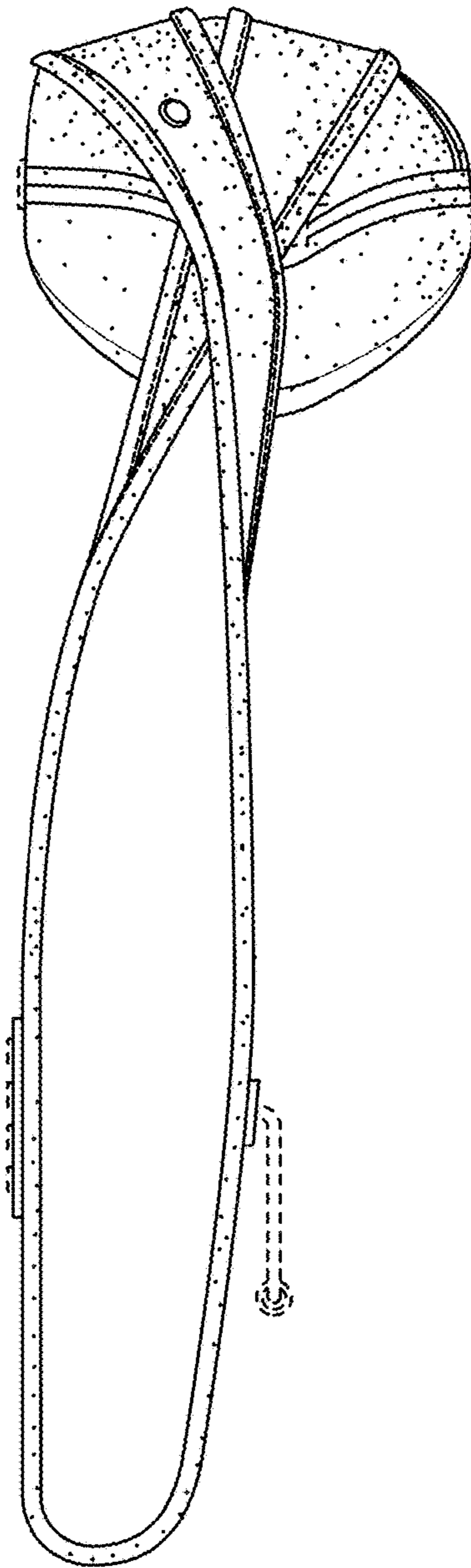

FIG. 12

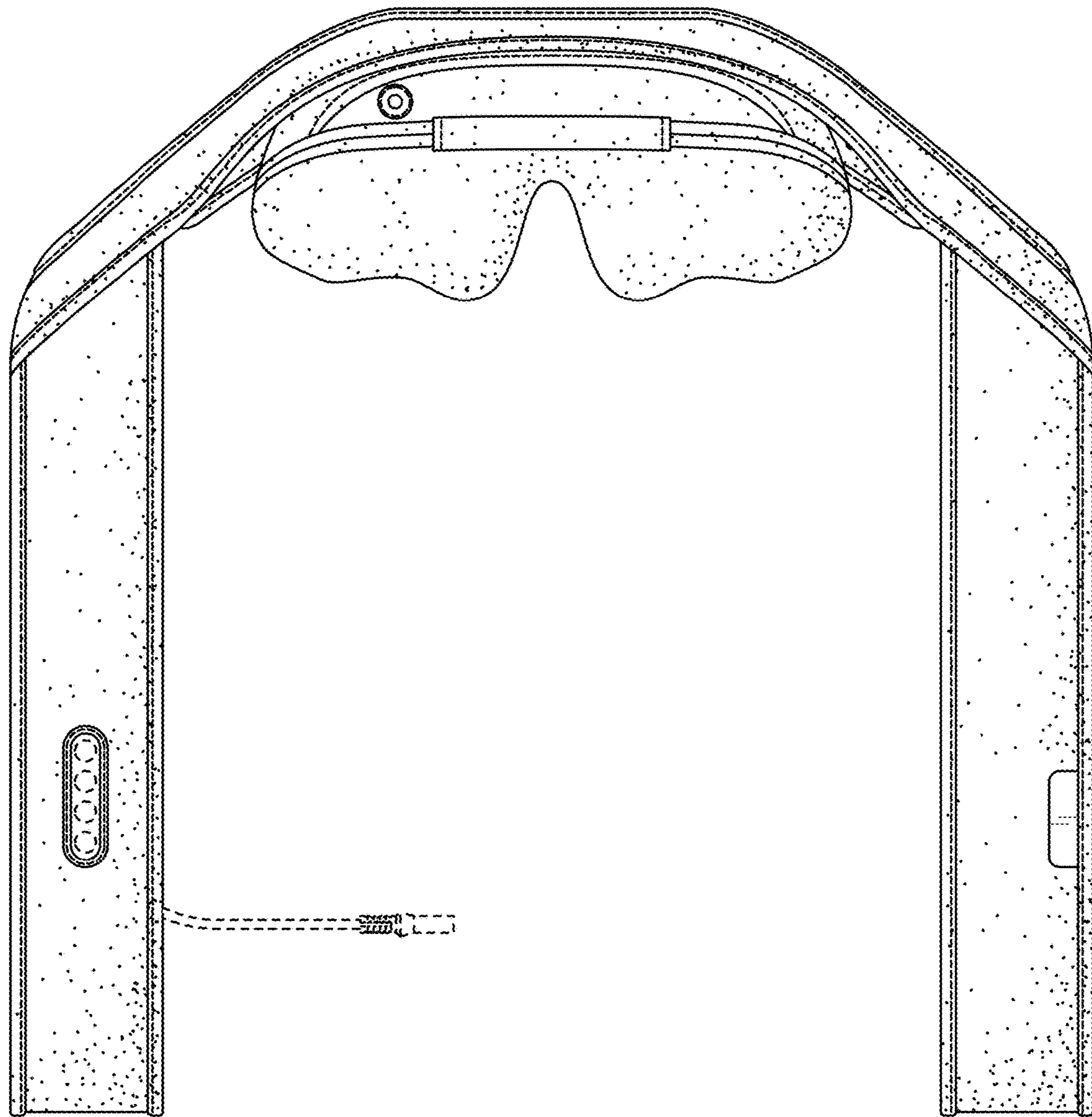

FIG. 13

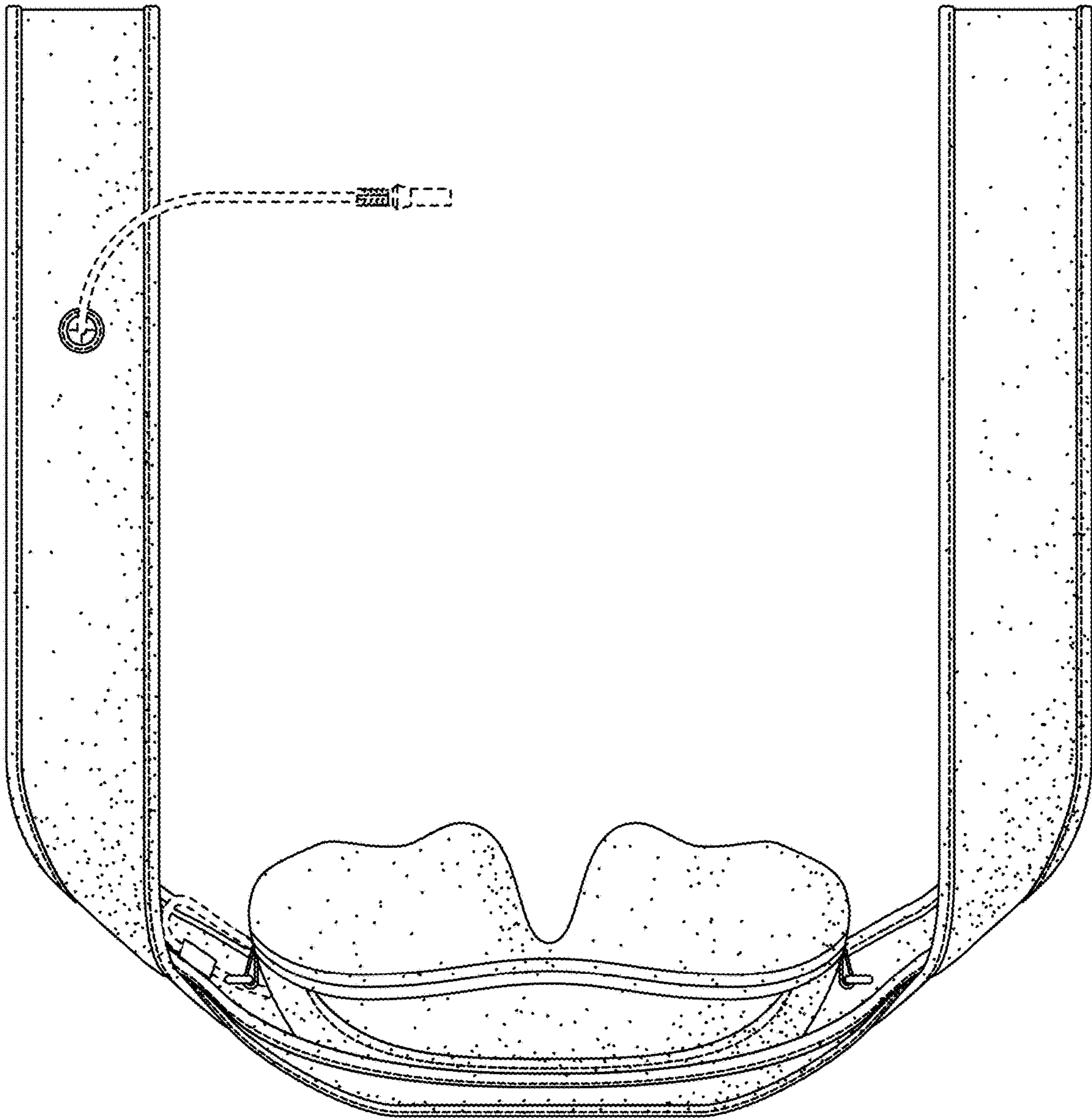

FIG. 14