



US00D851146S

(12) **United States Design Patent**
Thoni et al.

(10) **Patent No.:** **US D851,146 S**
(45) **Date of Patent:** **** Jun. 11, 2019**

- (54) **ACTUATOR**
- (71) Applicant: **Johnson Controls Technology Company**, Plymouth, MI (US)
- (72) Inventors: **Mark A. Thoni**, Pewaukee, WI (US); **Jeff Papendorf**, Milwaukee, WI (US); **John T. Pierson**, Whitefish Bay, WI (US); **Hyunchul Kim**, Chicago, IL (US); **Thomas Richardson**, Chicago, IL (US); **Scott J. Thorne**, Chicago, IL (US)
- (73) Assignee: **Johnson Controls Technology Company**, Auburn Hills, MI (US)
- (**) Term: **15 Years**
- (21) Appl. No.: **29/602,634**
- (22) Filed: **May 2, 2017**
- (51) **LOC (11) Cl.** **15-09**
- (52) **U.S. Cl.**
USPC **D15/148**
- (58) **Field of Classification Search**
USPC D12/345; D13/118, 158, 162, 184;
D15/1-5, 7, 9, 143, 148, 149, 199
CPC B66F 3/18; F16H 19/04; F16H 19/039;
H01F 7/066
See application file for complete search history.

- (56) **References Cited**
U.S. PATENT DOCUMENTS
- 4,510,850 A * 4/1985 Mack F15B 15/12
277/644
- 5,101,862 A * 4/1992 Leete F15B 15/12
137/486
- 5,283,704 A * 2/1994 Reidenbach G11B 21/16
360/244.5
- D400,220 S * 10/1998 Nemoto D15/148

6,003,431 A *	12/1999	Bertini	F15B 15/24 91/405
D597,111 S	7/2009	Takeuchi et al.		
D597,112 S	7/2009	Takeuchi et al.		
D610,655 S *	2/2010	Schmidt	D23/249
D628,219 S *	11/2010	Fukano	D15/143
D638,454 S	5/2011	Torii et al.		
D639,321 S	6/2011	Torii et al.		
D660,333 S	5/2012	Takeuchi et al.		
D660,334 S	5/2012	Takeuchi et al.		
D674,423 S *	1/2013	Mangold	D15/143
D719,595 S *	12/2014	Landerholm	D15/143
D749,226 S *	2/2016	Cooper	D24/188
D775,677 S *	1/2017	Jorgensen	D15/143
D789,432 S	6/2017	Tokuda		
D790,616 S	6/2017	Tokuda		
D790,617 S *	6/2017	Tokuda	D15/148
D795,935 S *	8/2017	Jorgensen	D15/148
D810,798 S *	2/2018	Tabuchi	D15/148
2004/0102274 A1 *	5/2004	Tesar	B64C 13/34 475/168

(Continued)

Primary Examiner — Patricia A Palasik
(74) *Attorney, Agent, or Firm* — Foley & Lardner LLP

(57) **CLAIM**

We claim the ornamental design for an actuator, as shown and described.

DESCRIPTION

FIG. 1 is a top, front, left perspective view of the claimed actuator;
 FIG. 2 is a bottom, rear, right perspective view thereof;
 FIG. 3 is a front view thereof;
 FIG. 4 is a rear view thereof;
 FIG. 5 is a left side view thereof;
 FIG. 6 is a right side view thereof;
 FIG. 7 is a top view thereof; and,
 FIG. 8 is a bottom view thereof.
 Any portion of the article depicted in broken lines forms no part of the claimed design.

1 Claim, 8 Drawing Sheets

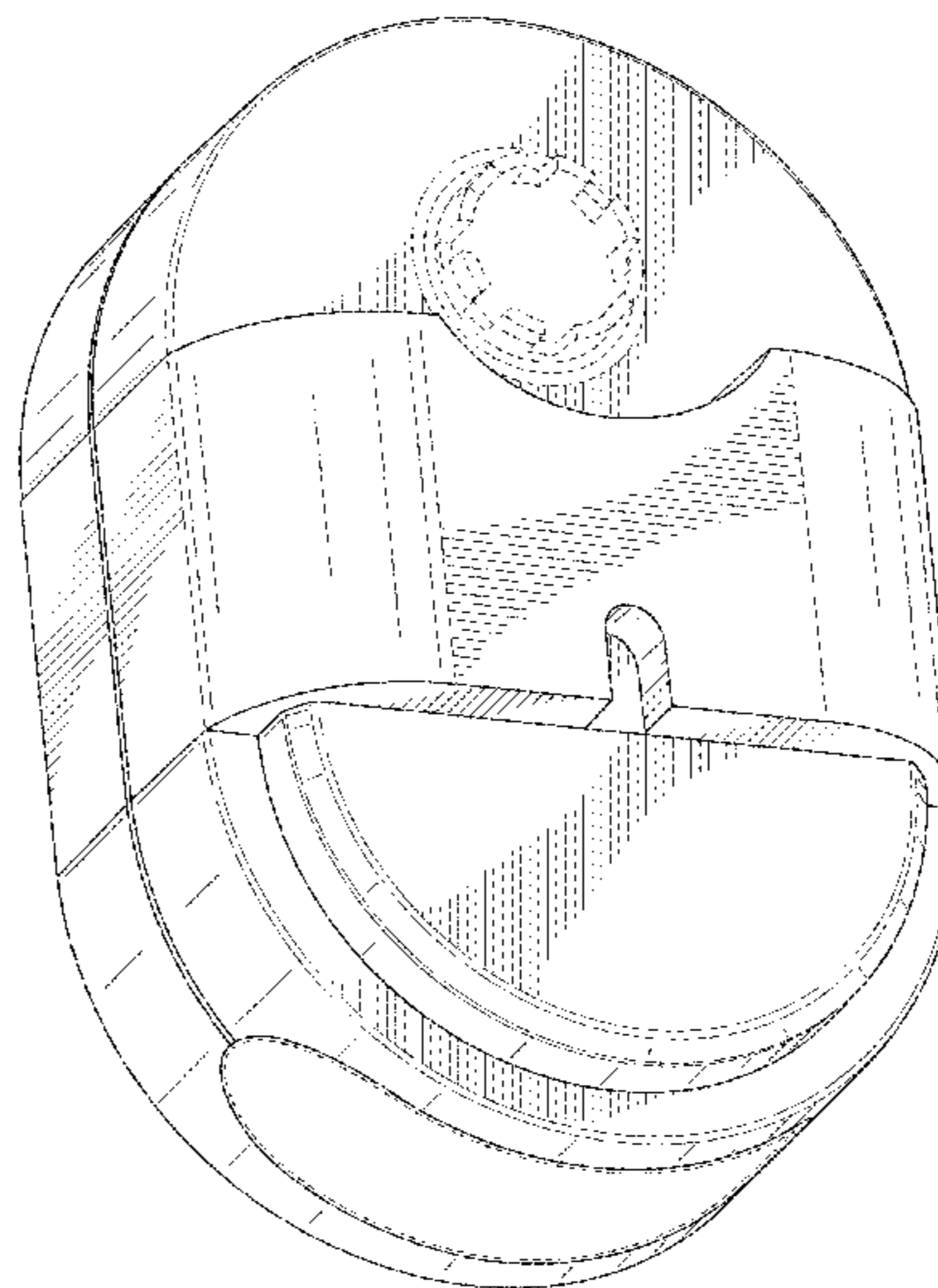
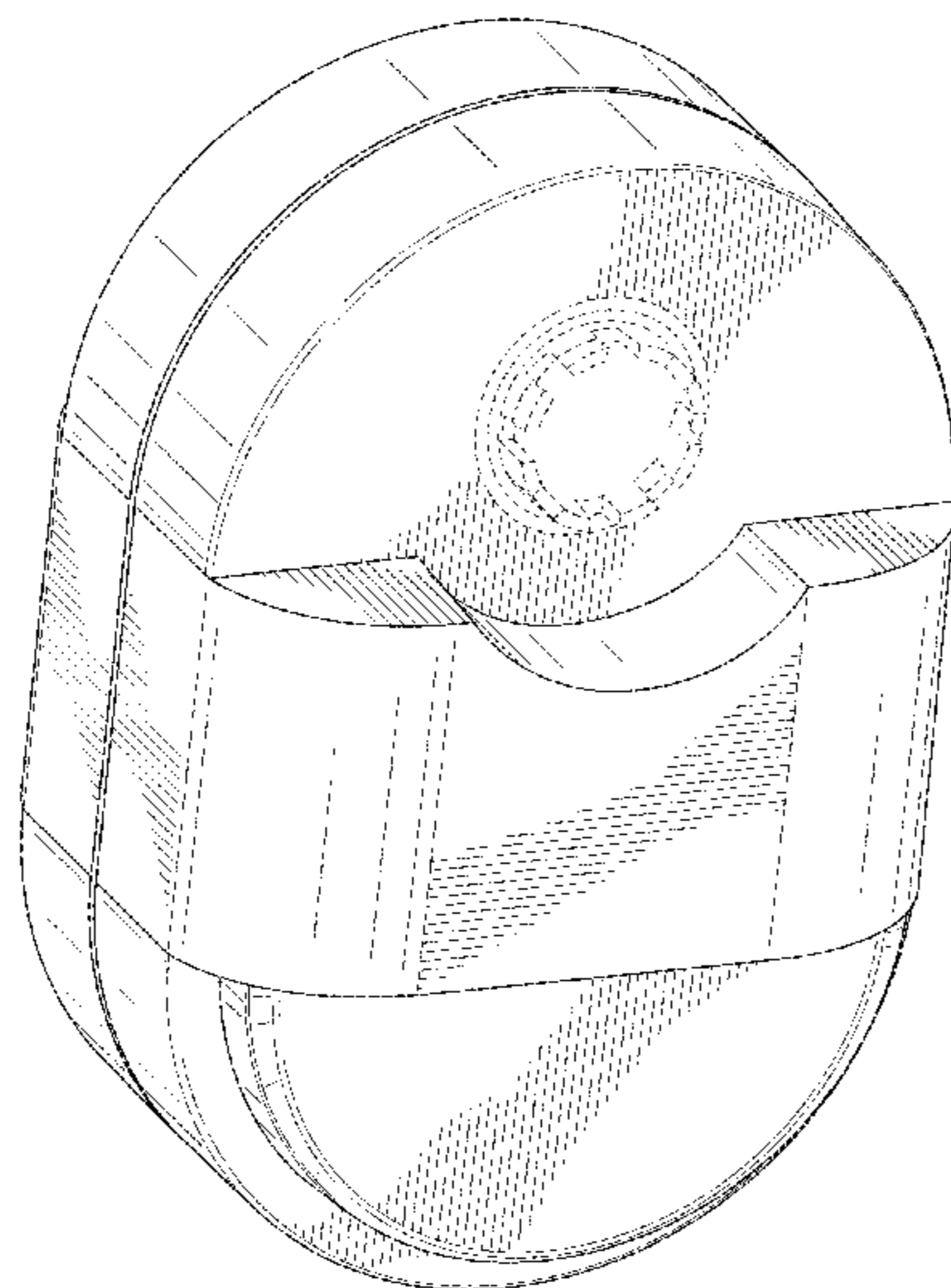

(56)

References Cited

U.S. PATENT DOCUMENTS

2005/0122855 A1* 6/2005 Choi G11B 7/0933
369/44.15
2006/0125300 A1* 6/2006 Stemmer B60N 2/167
297/353
2007/0249457 A1* 10/2007 Tesar B64C 13/34
475/180
2008/0120977 A1* 5/2008 Safran F03G 7/06
60/531
2010/0064885 A1* 3/2010 Werkhoven F15B 1/12
92/121
2010/0234967 A1* 9/2010 Whiteley H02K 7/116
623/24
2011/0113912 A1* 5/2011 Heurich F16H 61/28
74/473.11
2014/0224064 A1* 8/2014 Tesar H02K 7/116
74/606 R
2015/0117938 A1* 4/2015 Flatley F16D 1/108
403/292
2015/0226367 A1* 8/2015 Day F16K 31/086
62/50.7
2016/0290371 A1* 10/2016 Ryu F15B 15/12
2017/0114808 A1* 4/2017 Cowie E21B 34/02
2017/0222517 A1* 8/2017 Kobayashi H02K 7/116
2018/0172032 A1* 6/2018 Modinger F16K 31/1635

* cited by examiner

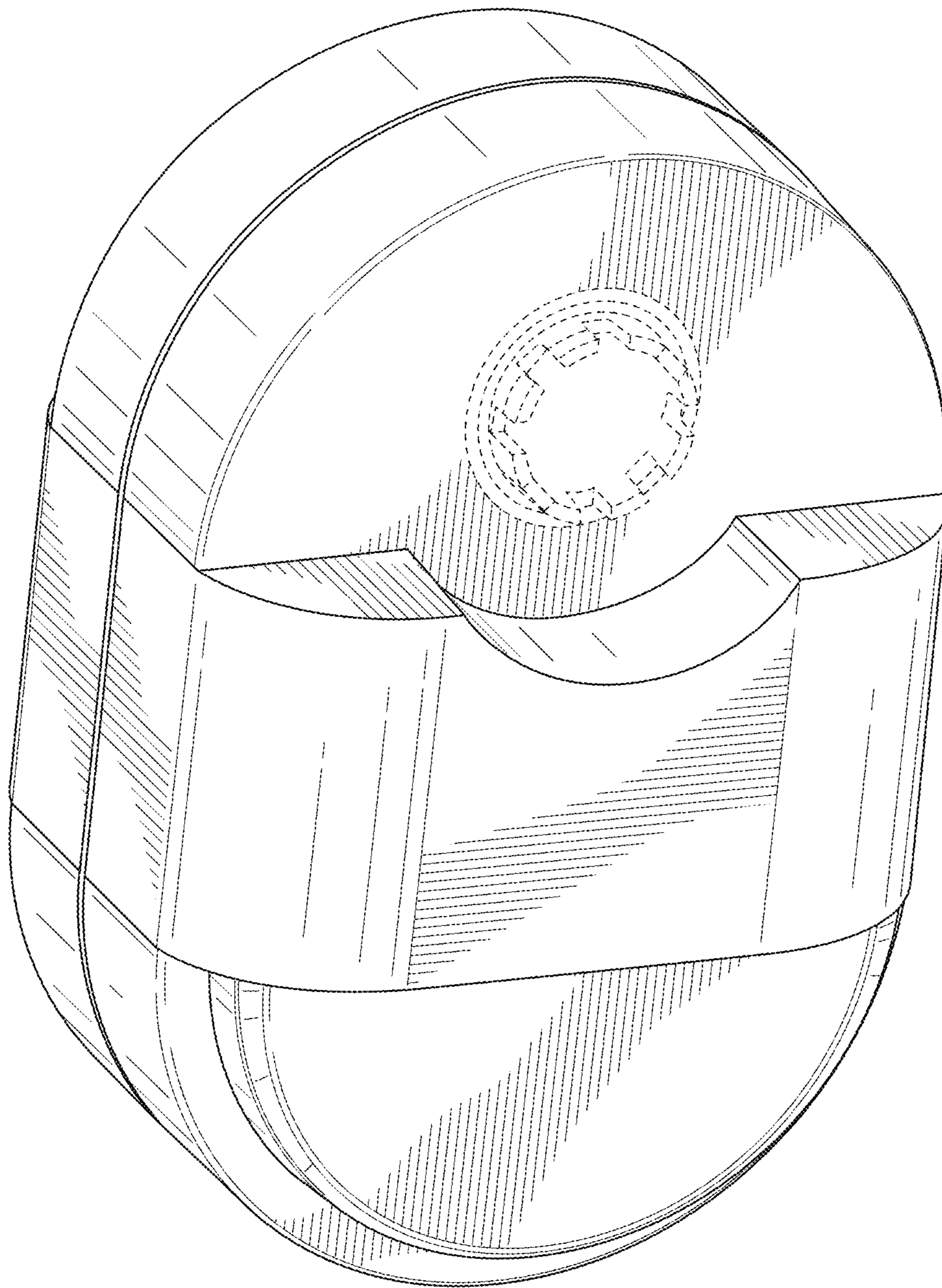

FIG. 1

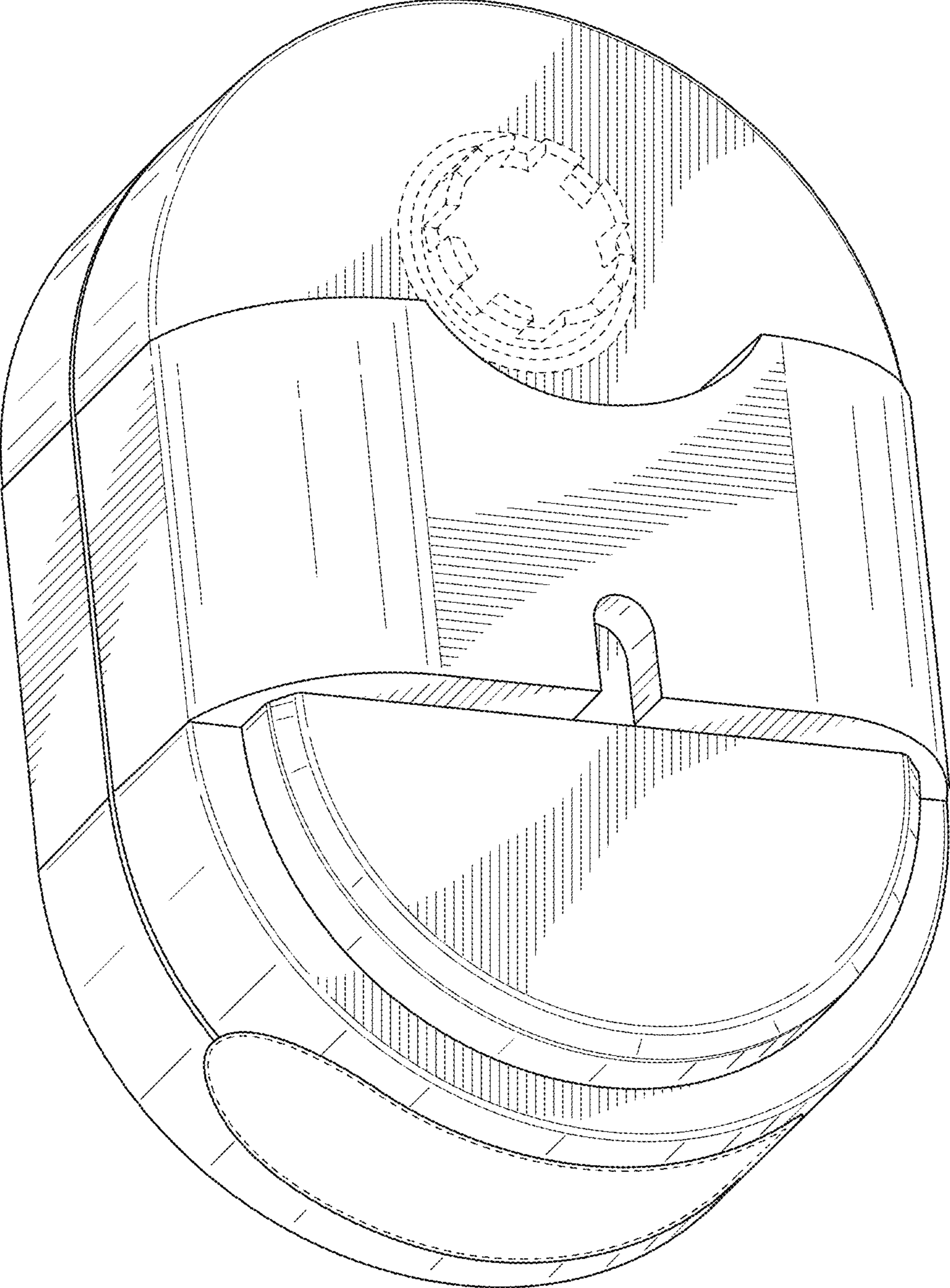

FIG. 2

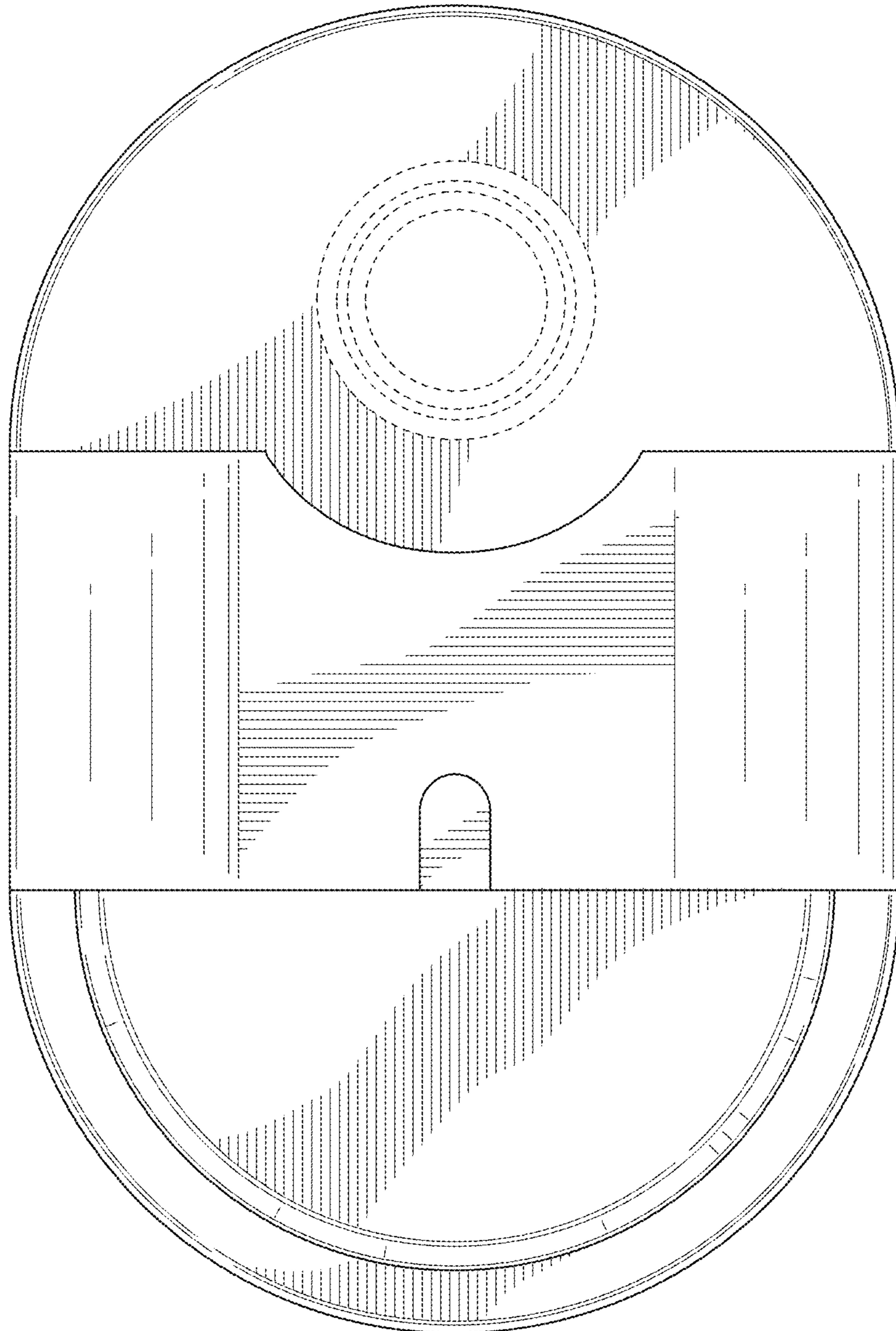

FIG. 3

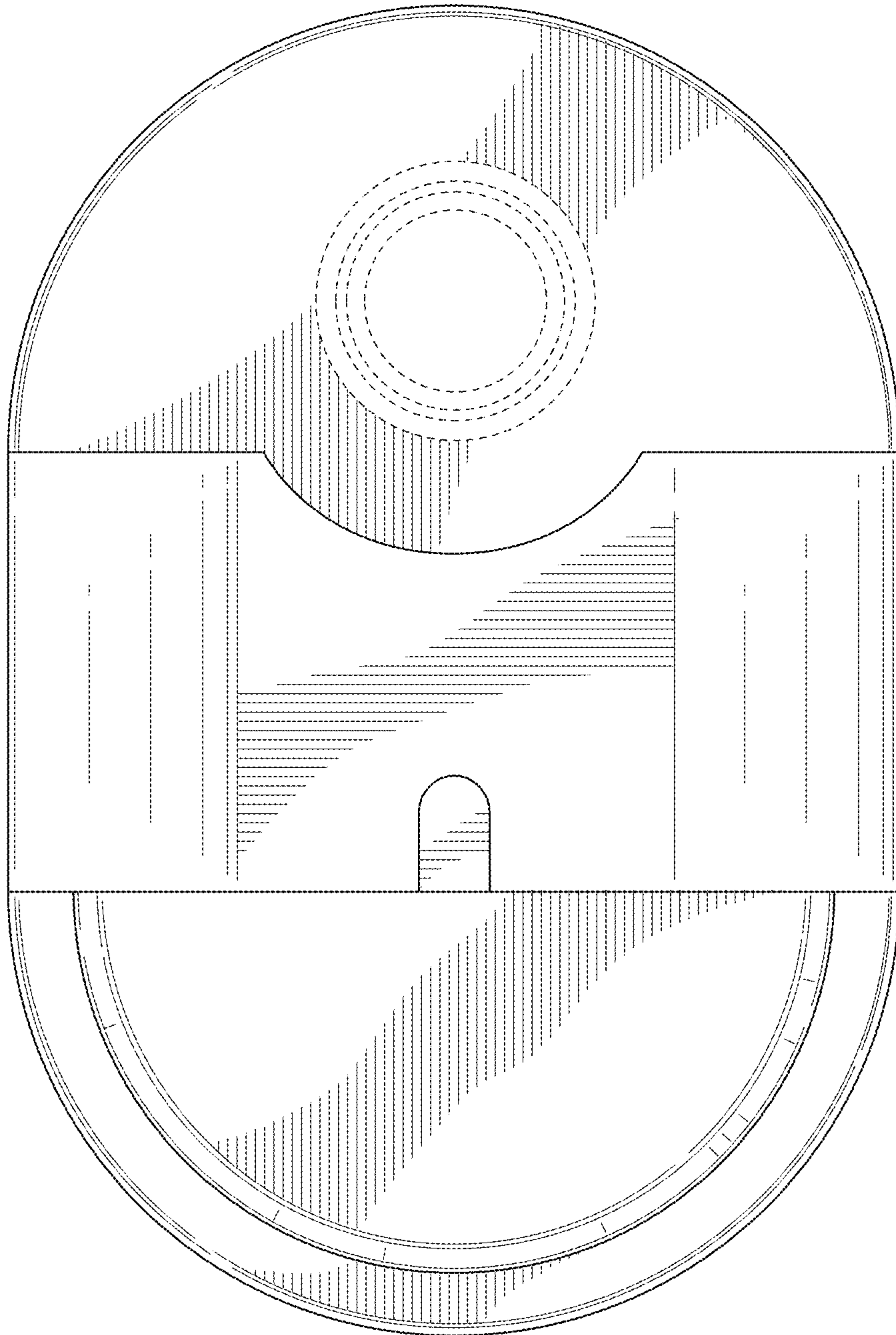

FIG. 4

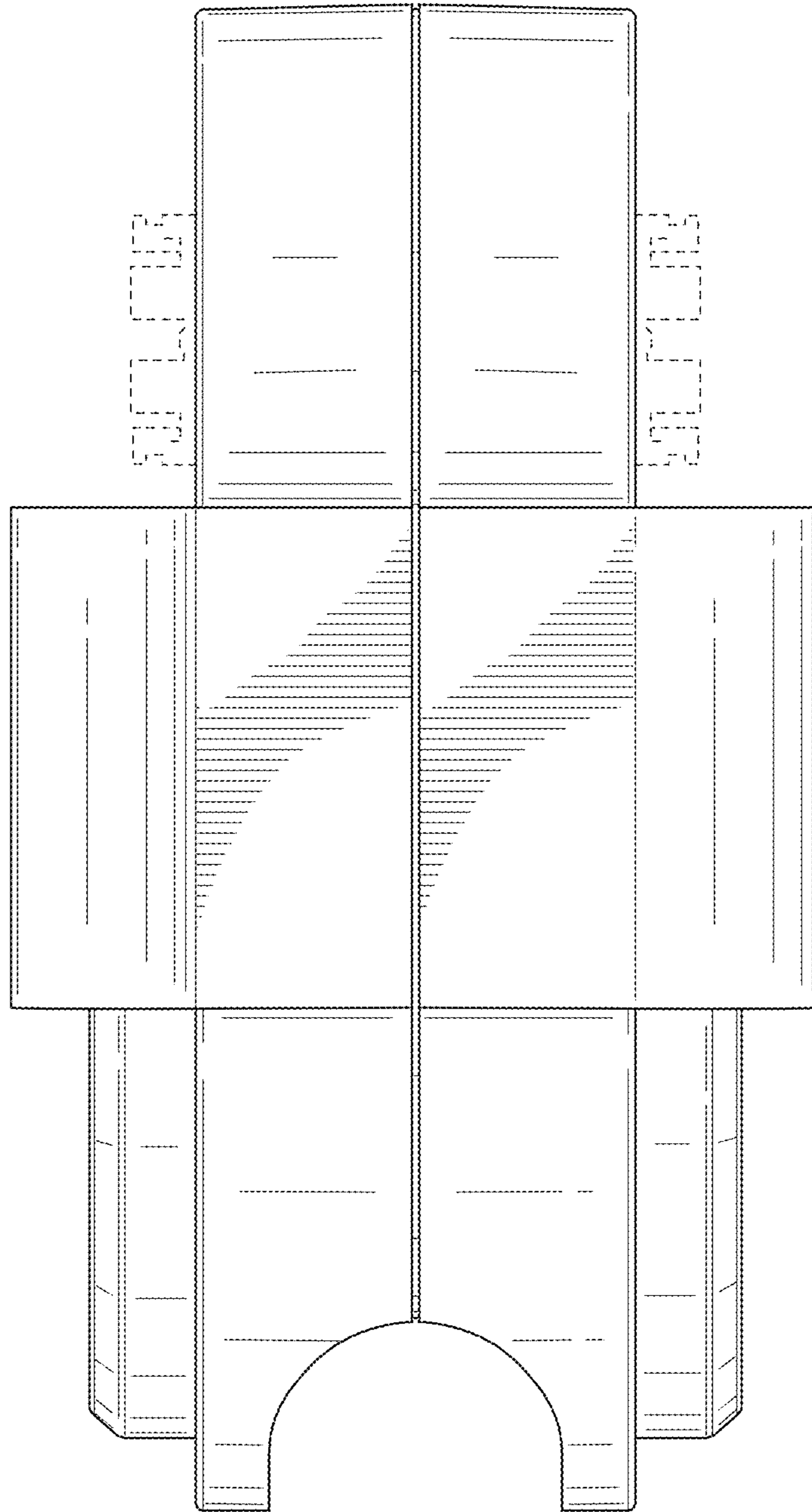

FIG. 5

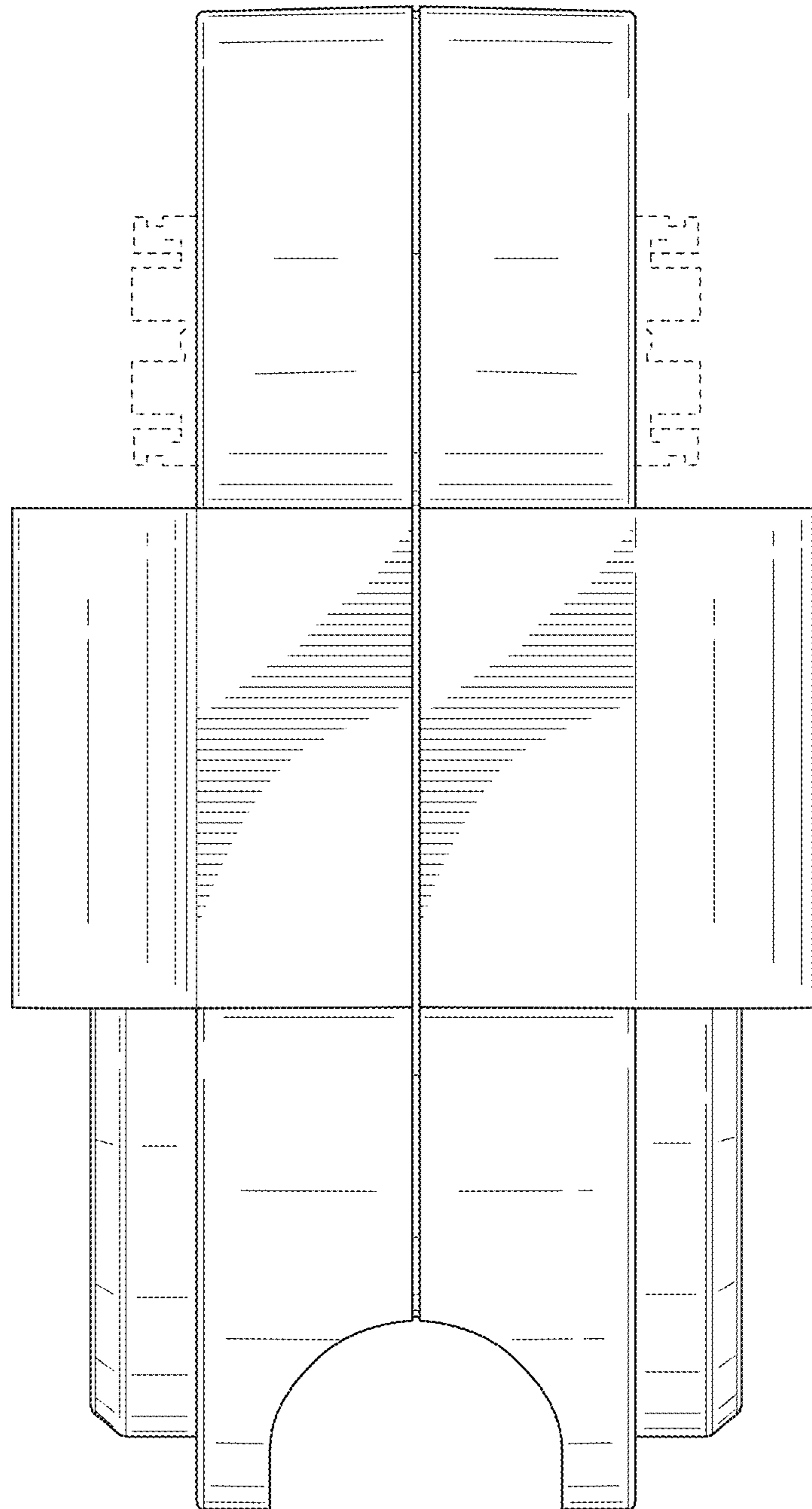

FIG. 6

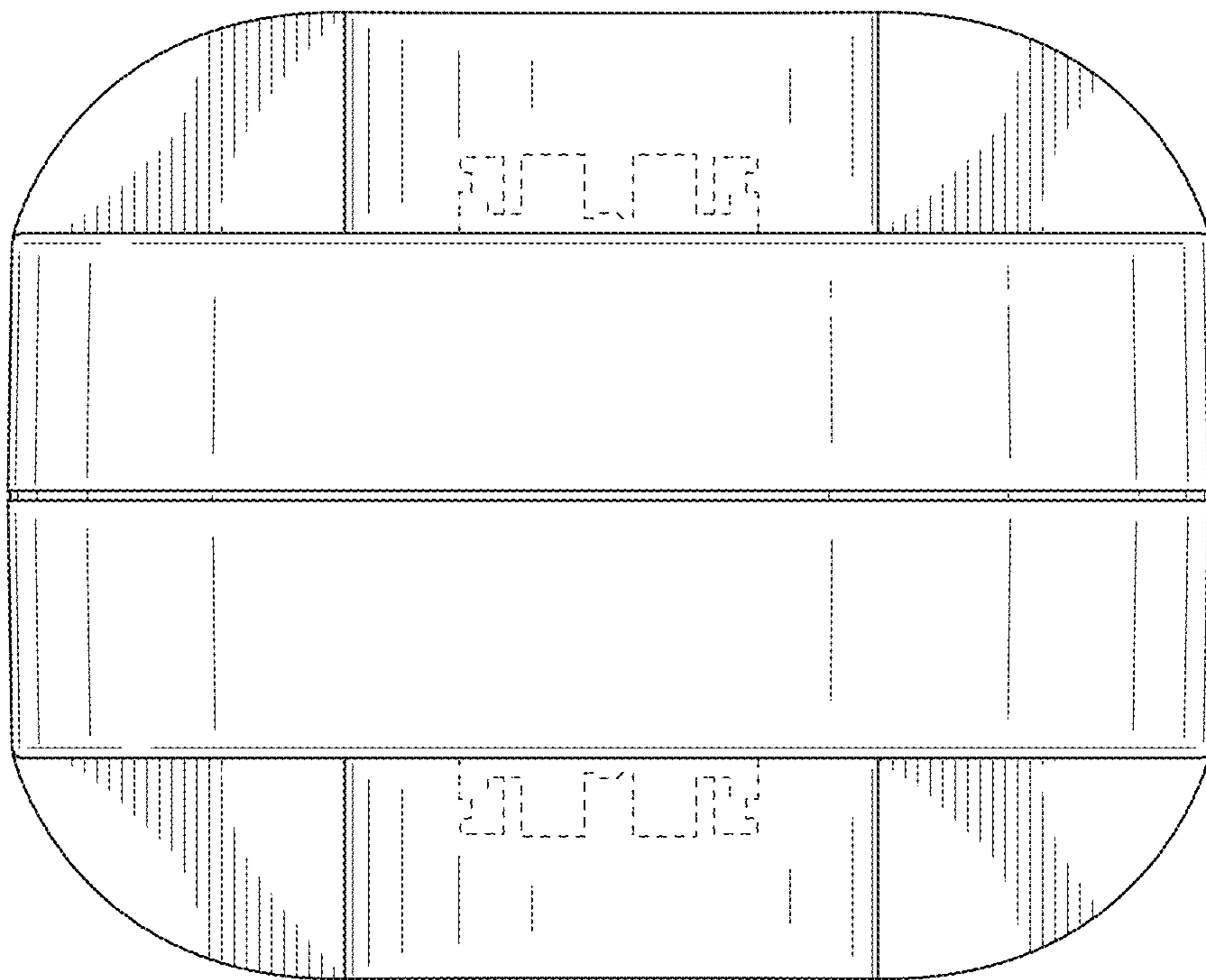

FIG. 7

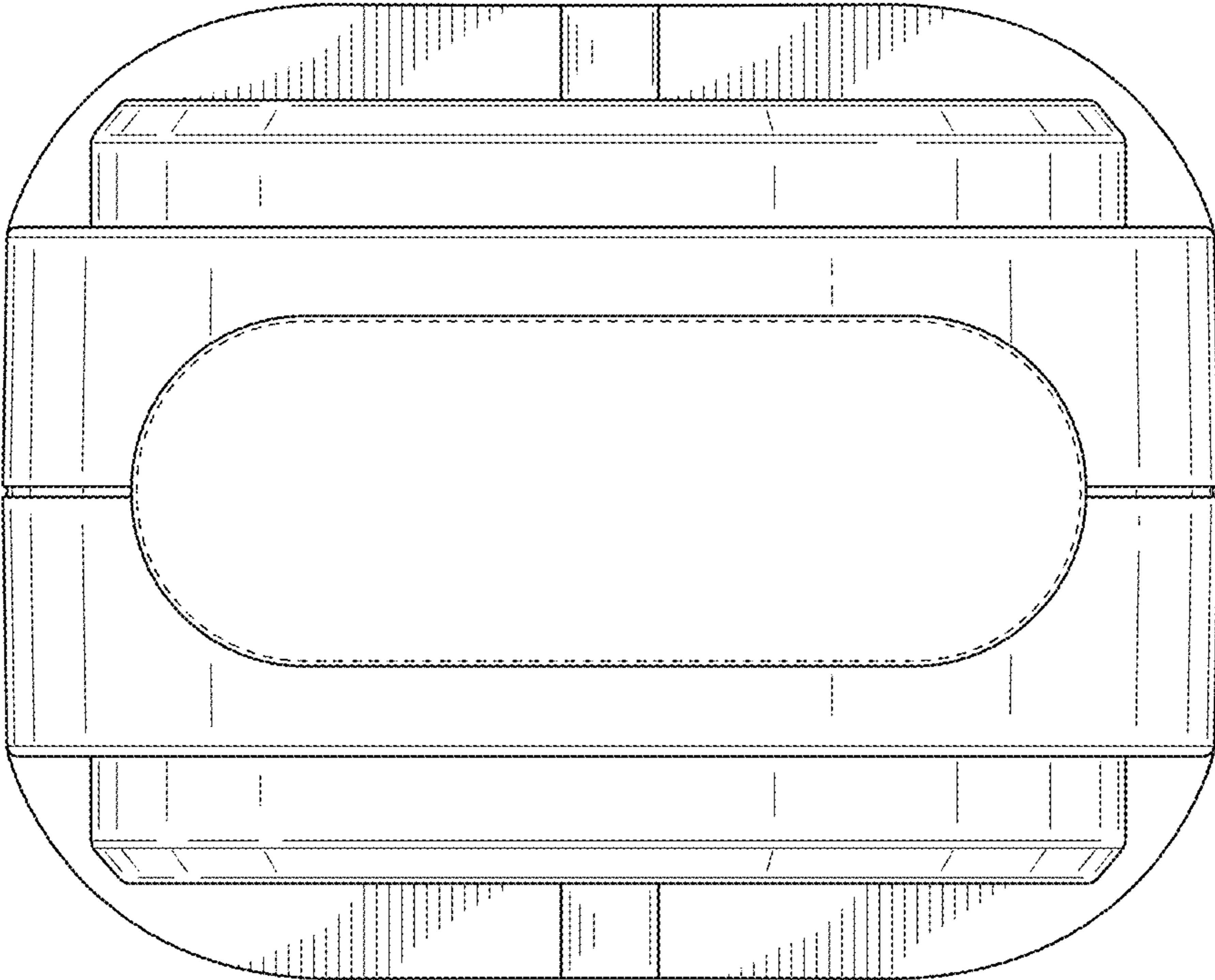

FIG. 8