



US00D851054S

(12) **United States Design Patent** (10) **Patent No.:** **US D851,054 S**
Nalbandian et al. (45) **Date of Patent:** **** Jun. 11, 2019**

(54) **MOBILE DEVICE**

(71) Applicant: **Razer (Asia-Pacific) Pte. Ltd.**,
Singapore (SG)

(72) Inventors: **Saro Nalbandian**, San Francisco, CA
(US); **Scott Croyle**, San Francisco, CA
(US)

(73) Assignee: **RAZER (ASIA-PACIFIC) PTE. LTD.**,
Singapore (SG)

(**) Term: **15 Years**

(21) Appl. No.: **29/623,587**

(22) Filed: **Oct. 25, 2017**

(51) **LOC (11) Cl.** **14-03**

(52) **U.S. Cl.**
USPC **D14/138 G**

(58) **Field of Classification Search**
USPC D14/138 G, 341

(Continued)

(56) **References Cited**

U.S. PATENT DOCUMENTS

D502,162 S * 2/2005 Kim D14/138 AD
D541,785 S * 5/2007 Hwang D14/138 G

(Continued)

OTHER PUBLICATIONS

Apple iPhone 7 Plus, announced Sep. 2016, [online], [retrieved on
Jan. 26, 2019]. Retrieved from Internet, <URL: <http://www.gsmarena.com>>.*

(Continued)

Primary Examiner — Bridget L Eland

(74) *Attorney, Agent, or Firm* — Polsinelli PC

(57) **CLAIM**

We claim the ornamental design for a mobile device, as
shown and described.

DESCRIPTION

The patent or application file contains at least one drawing
executed in color. Copies of this patent or patent application
publication with color drawing(s) will be provided by the
Office upon request and payment of the necessary fee.

FIG. 1 is a perspective view of a first embodiment of a
mobile device, showing our new design;

FIG. 2 is a front elevation view thereof;

FIG. 3 is a rear elevation view thereof;

FIG. 4 is a right side elevation view thereof;

FIG. 5 is a left side elevation view thereof;

FIG. 6 is a top plan view thereof; and

FIG. 7 is a bottom plan view thereof.

FIG. 8 is a perspective view of a second embodiment of a
mobile device, showing our new design;

FIG. 9 is a front, right side perspective view thereof;

FIG. 10 is a right side elevation view thereof;

FIG. 11 is a rear elevation view thereof; and

FIG. 12 is a left side rear perspective view thereof.

FIG. 13 is a perspective view of a third embodiment of a
mobile device, showing our new design;

FIG. 14 is a front, right side perspective view thereof;

FIG. 15 is a right side elevation view thereof;

FIG. 16 is a rear elevation view thereof; and,

FIG. 17 is a left side rear perspective view thereof.

The outermost broken lines immediately adjacent the claim,
encompassing regions blocked out by white or grey, repre-
sent the bounds of the claimed design while all other broken
lines are directed to environment and are for illustrative
purposes only; the broken lines form no part of the claimed
design.

The logo in the Embodiments forming part of the disclosure
is a registered trademark of RAZER (ASIA-PACIFIC) PTE.
LTD.

1 Claim, 17 Drawing Sheets
(4 of 17 Drawing Sheet(s) Filed in Color)

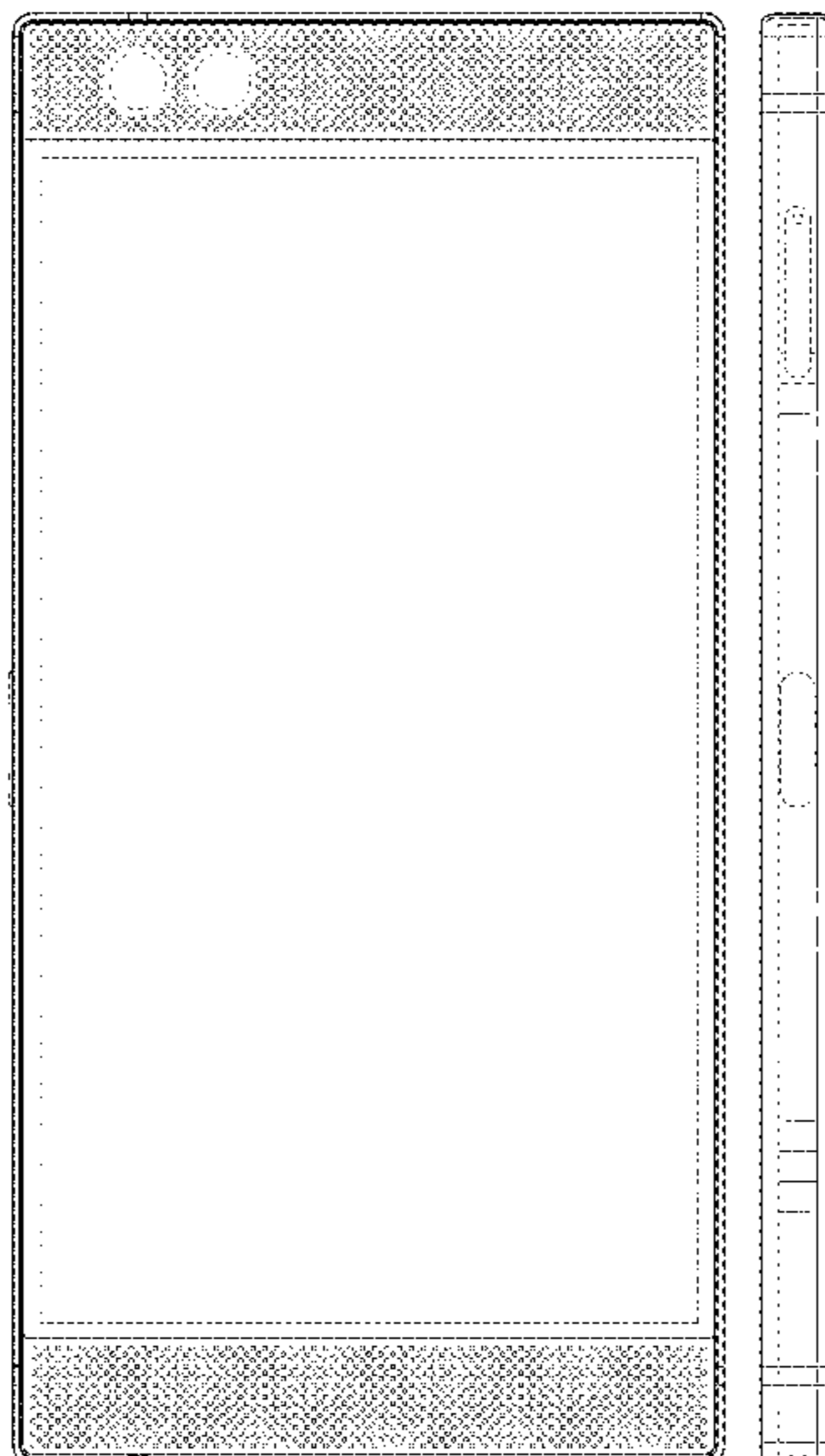

(58) **Field of Classification Search**

CPC H04M 1/0202; H04M 1/0235; H04M
1/0237; H04M 1/0239; H04M 1/0266;
H04M 1/0268; H04M 1/027; H04M
1/0295

See application file for complete search history.

(56) **References Cited**

U.S. PATENT DOCUMENTS

D546,810 S * 7/2007 Kwak D14/138 AA
D583,344 S * 12/2008 Sohn D14/138 AD
D583,346 S * 12/2008 Jung D14/138 AD
D609,680 S * 2/2010 Kim D14/138 AD
D616,852 S * 6/2010 Kim D14/138 AD
D622,718 S * 8/2010 Andre D14/341
D622,719 S * 8/2010 Andre D14/341
D654,464 S * 2/2012 Han D14/138 G
D662,907 S * 7/2012 Sim D14/138 G
D670,262 S * 11/2012 Mitchell D14/138 G
D673,924 S * 1/2013 Mitchell D14/138 G
D683,711 S * 6/2013 Hofer D14/138 G
D695,704 S * 12/2013 Kim D14/138 G
D736,766 S * 8/2015 Paschke D14/138 G
D745,004 S * 12/2015 Kim H04M 1/0268
D14/341
D745,483 S * 12/2015 Dhondt D14/138 G
D755,148 S * 5/2016 Wu D14/138 G
D760,707 S * 7/2016 Walliser D14/248
D762,607 S * 8/2016 Yoon D14/138 G
D768,594 S * 10/2016 Szeto D14/138 G

D770,433 S * 11/2016 Kangasmaa D14/248
D774,486 S * 12/2016 Defazio D14/138 G
D777,700 S * 1/2017 Kwon D14/138 G
D780,179 S * 2/2017 Bae D14/138 G
D783,564 S * 4/2017 Park D14/138 C
D788,733 S * 6/2017 Park D14/138 G
D791,732 S * 7/2017 Xu D14/138 G
D801,947 S * 11/2017 Gordon D14/138 G
D808,952 S * 1/2018 Defazio D14/341
D812,049 S * 3/2018 Akana D14/341
D817,297 S * 5/2018 Lee D14/138 G
D820,801 S * 6/2018 Yeom D14/138 AB
D822,633 S * 7/2018 Yeom D14/138 AB
D823,272 S * 7/2018 Croyle D14/138 G
D827,625 S * 9/2018 Berneth D14/248
D838,270 S * 1/2019 Cho D14/341
2008/0045279 A1 * 2/2008 Ohki H04M 1/0247
455/575.1

OTHER PUBLICATIONS

Plum Might, announced May 2012, [online], [retrieved on Nov. 28, 2012]. Retrieved from Internet ,<URL: <http://www.gsmarena.com>>.*
HTC One, announced Feb. 2013, [online], [retrieved on Mar. 4, 2013]. Retrieved from Internet ,<URL: <http://www.gsmarena.com>>.*
BlackBerry Z10, announced Jan. 2013, [online], [retrieved on Mar. 4, 2013]. Retrieved from Internet ,<URL: <http://www.gsmarena.com>>.*

* cited by examiner

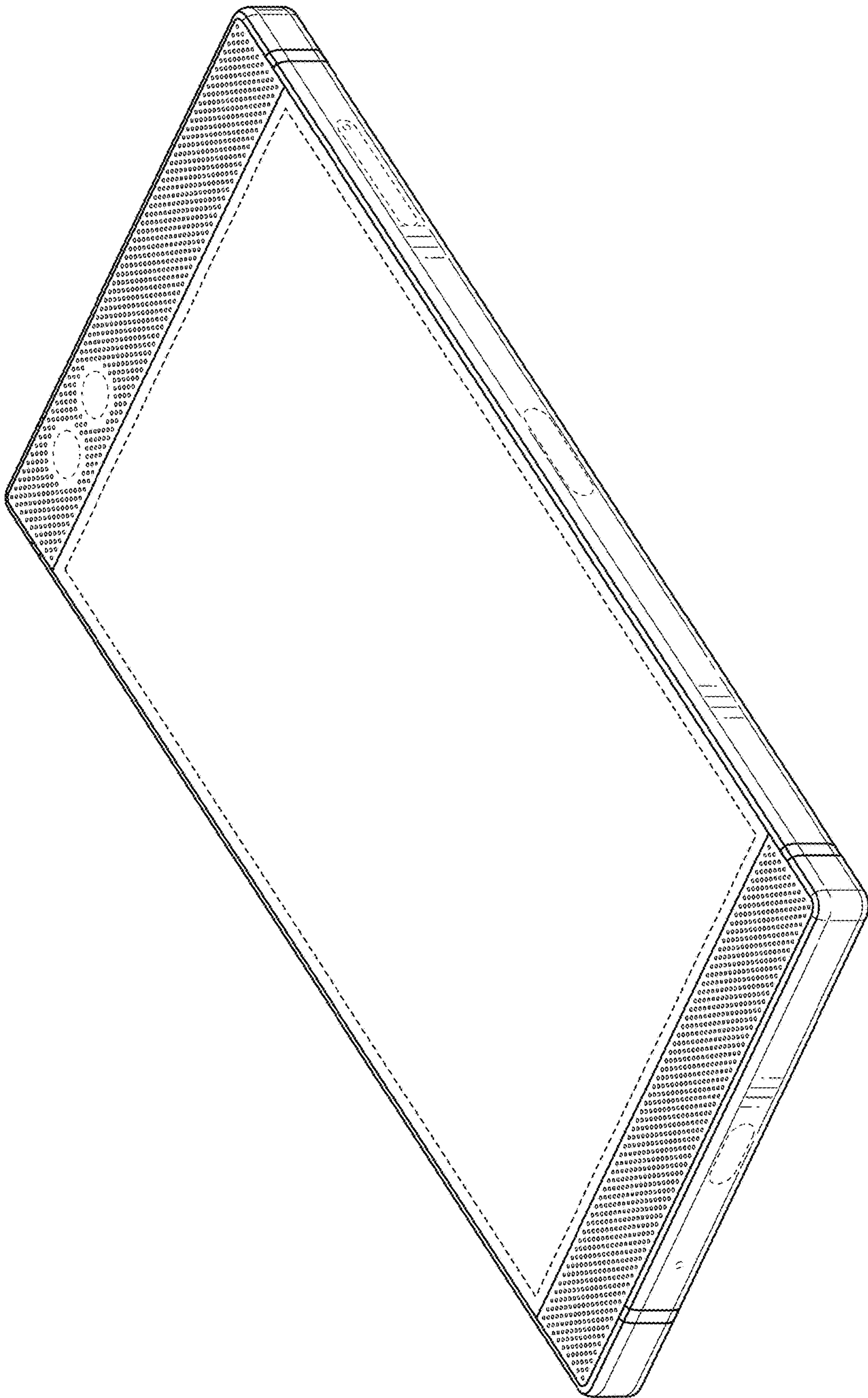

FIG. 1

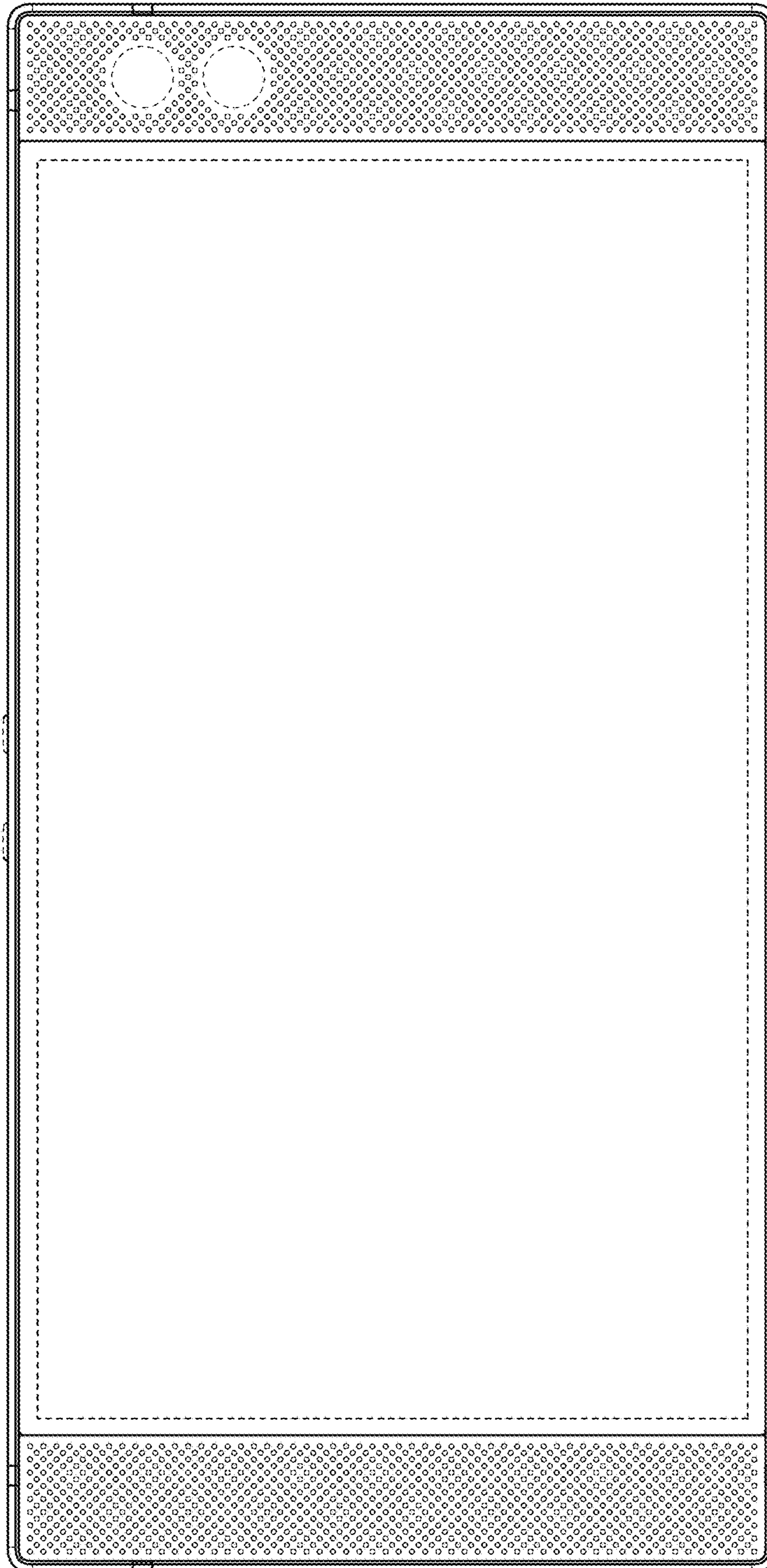

FIG. 2

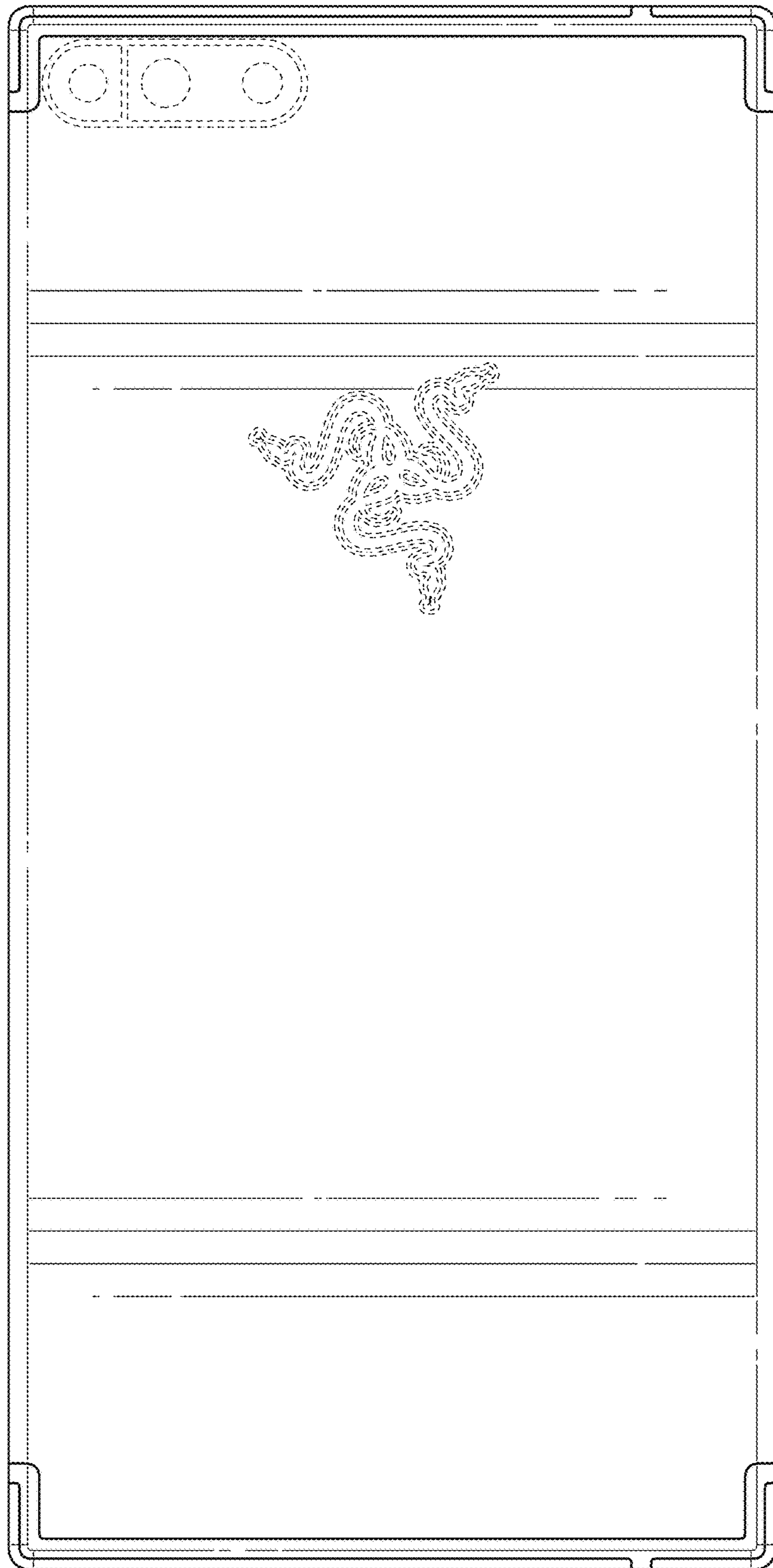

FIG. 3

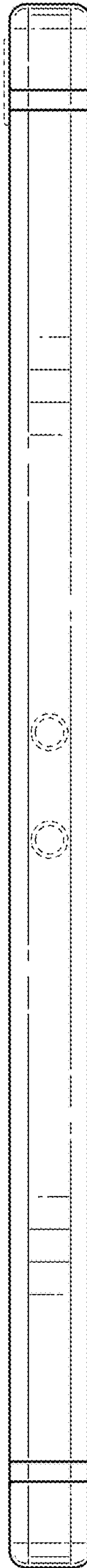

FIG. 4

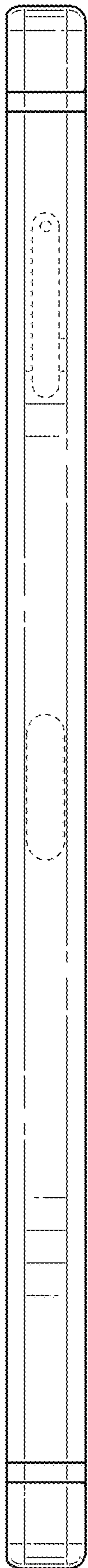

FIG. 5

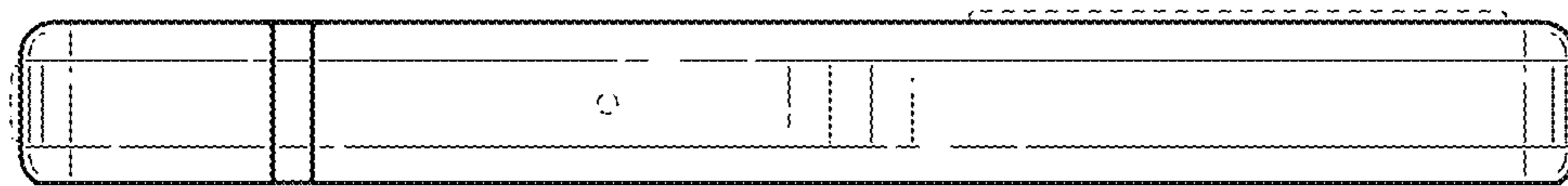

FIG. 6

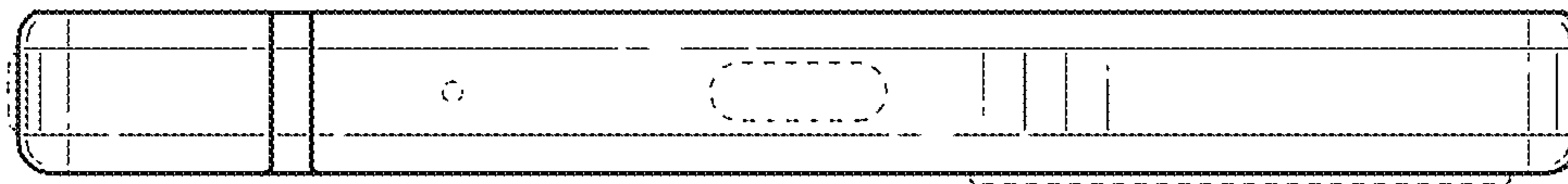

FIG. 7

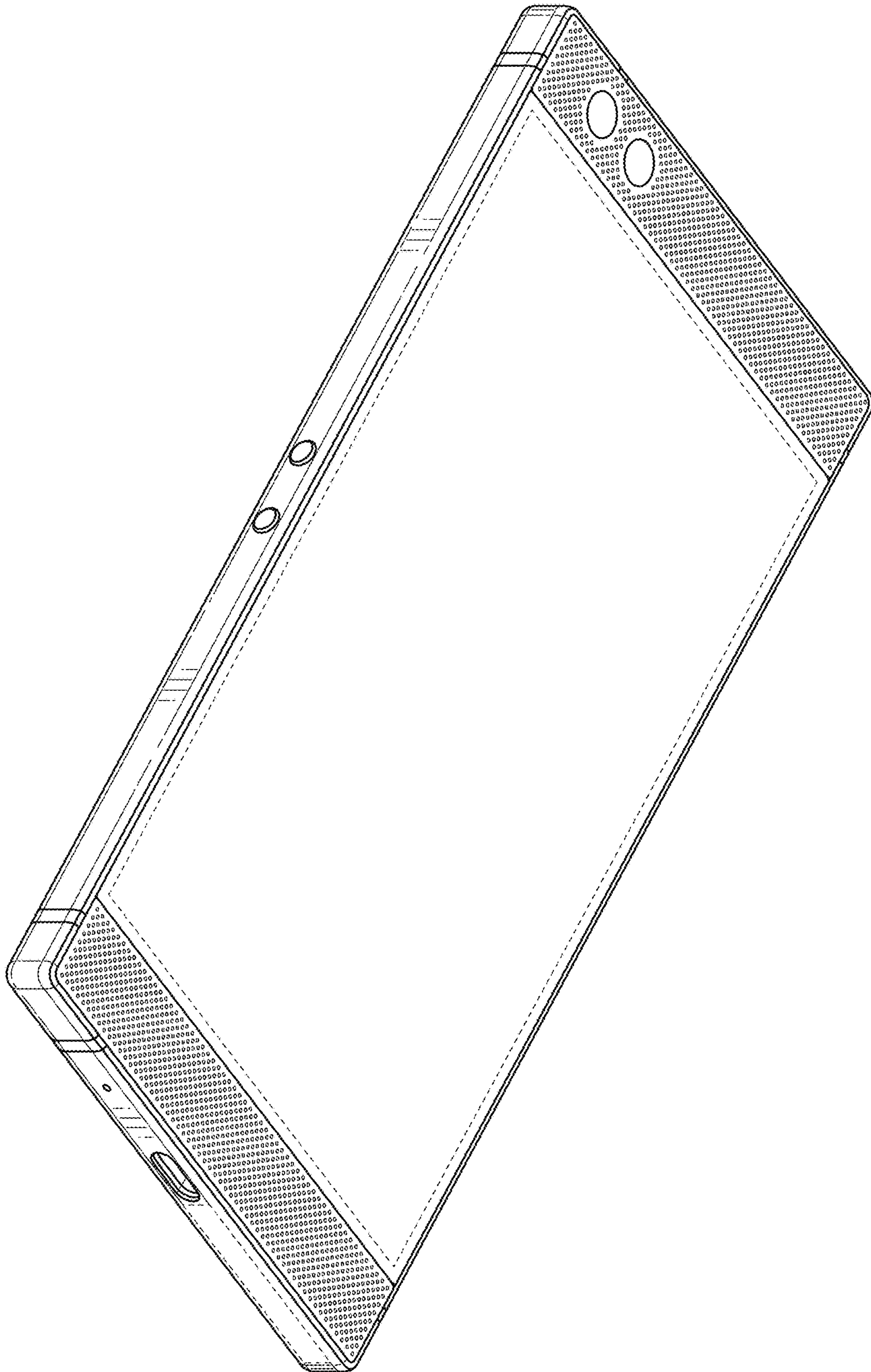

FIG. 8

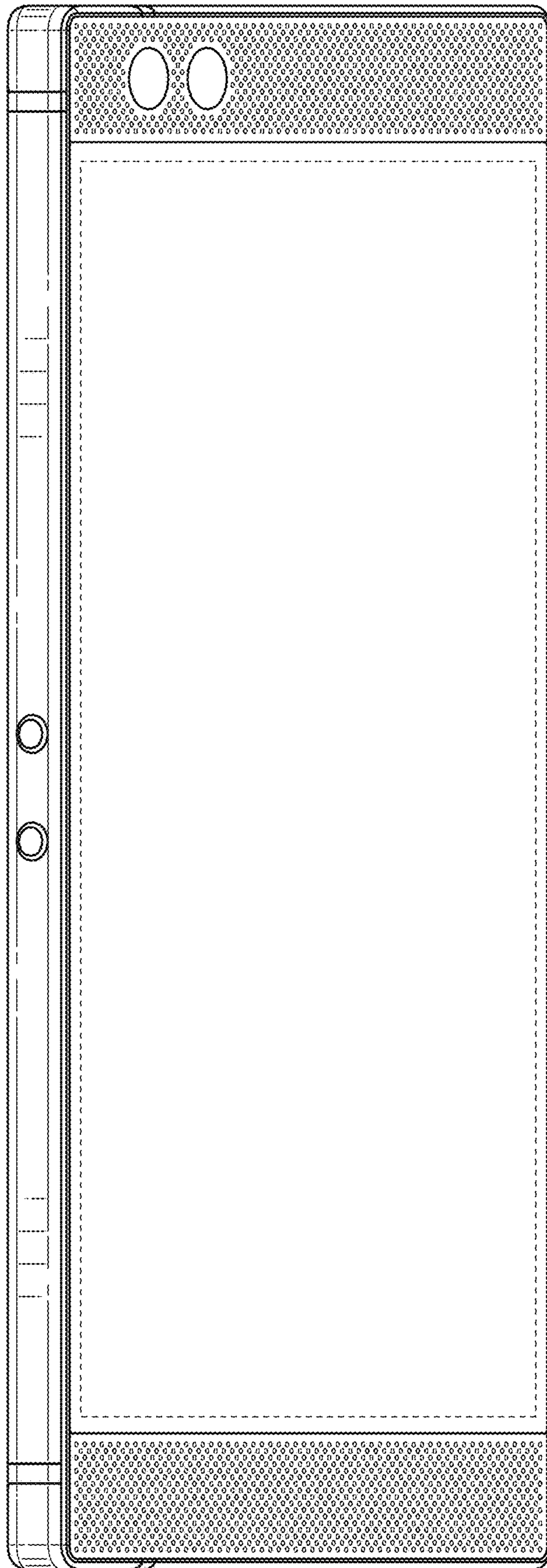

FIG. 9

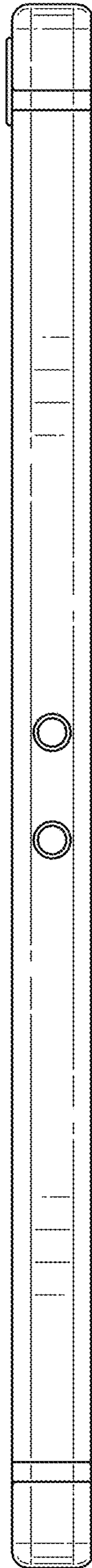

FIG. 10

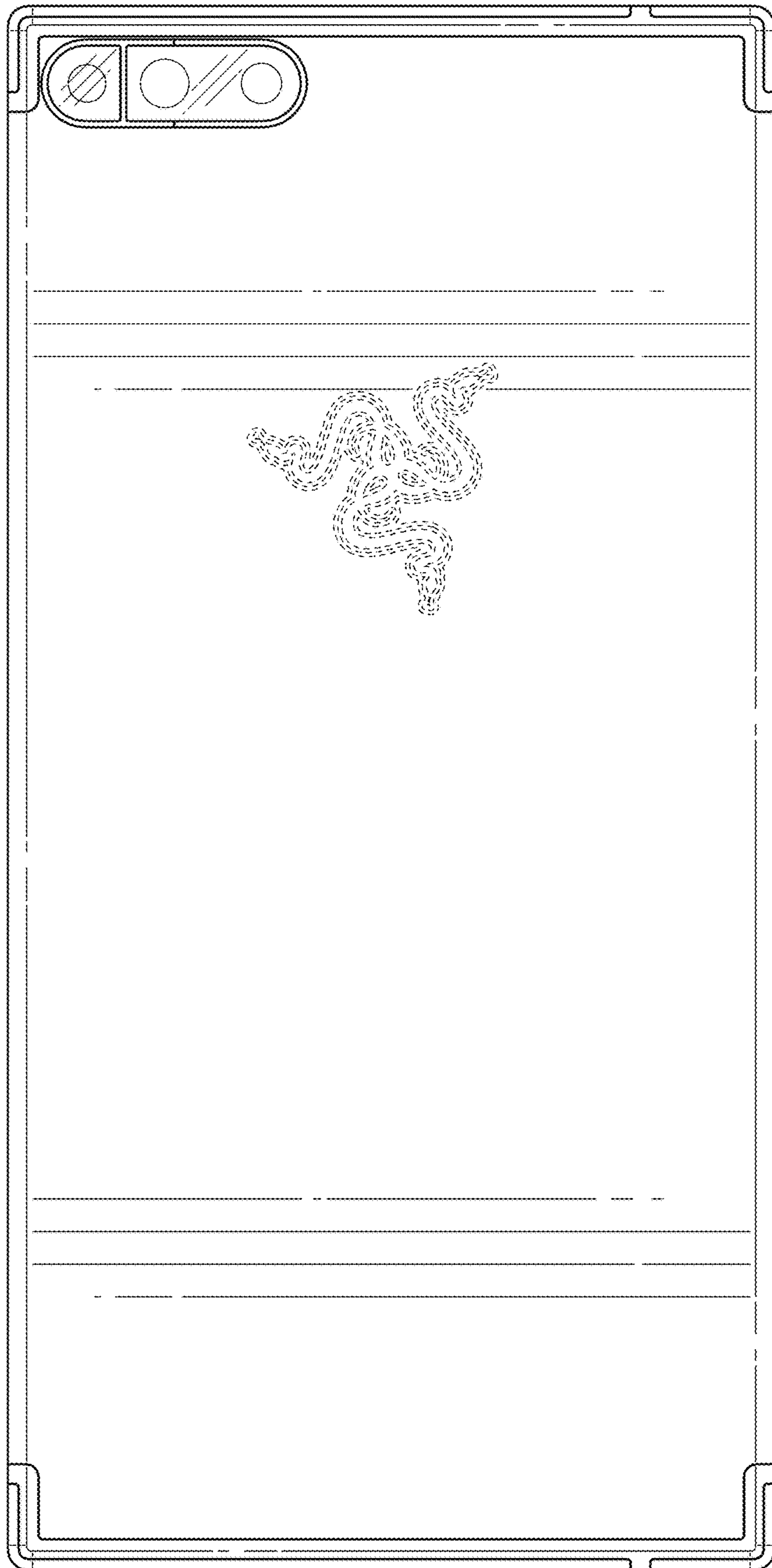

FIG. 11

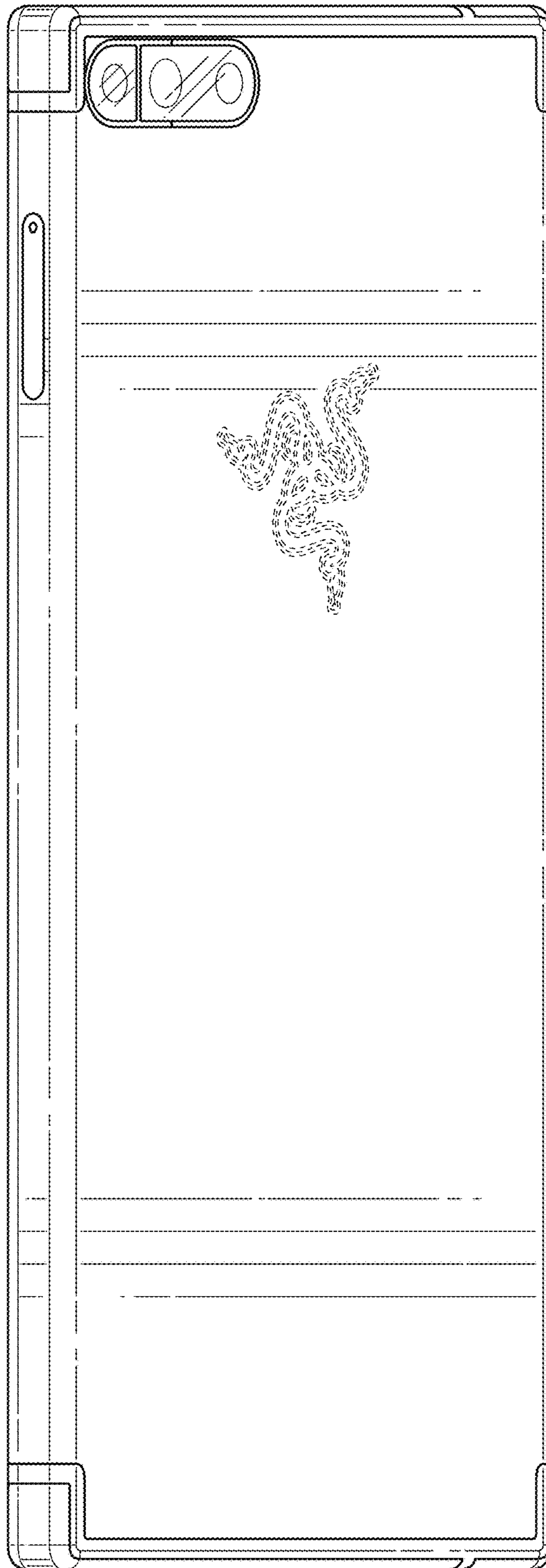

FIG. 12



FIG. 13

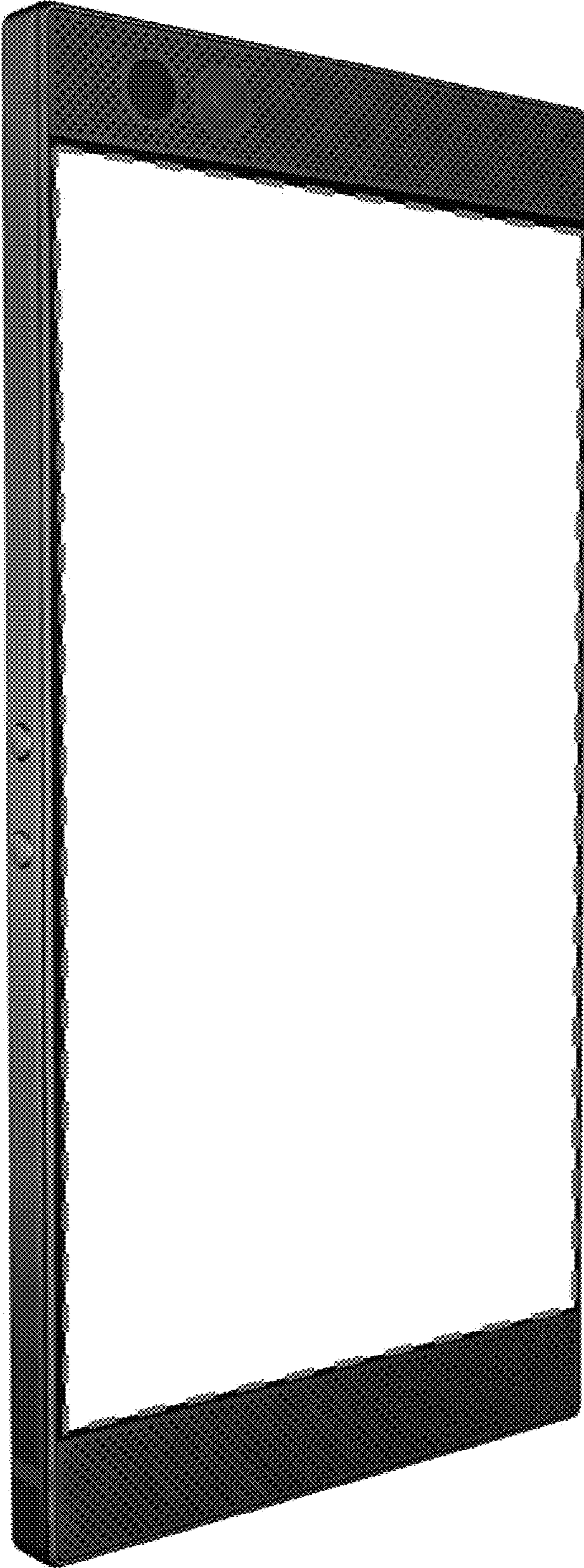

FIG. 14

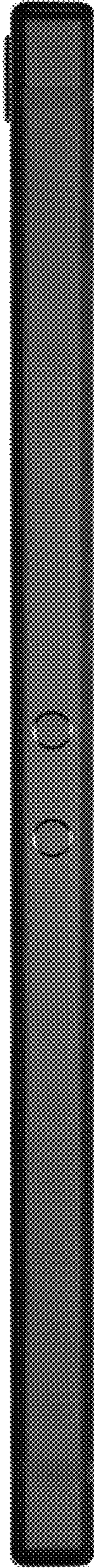

FIG. 15

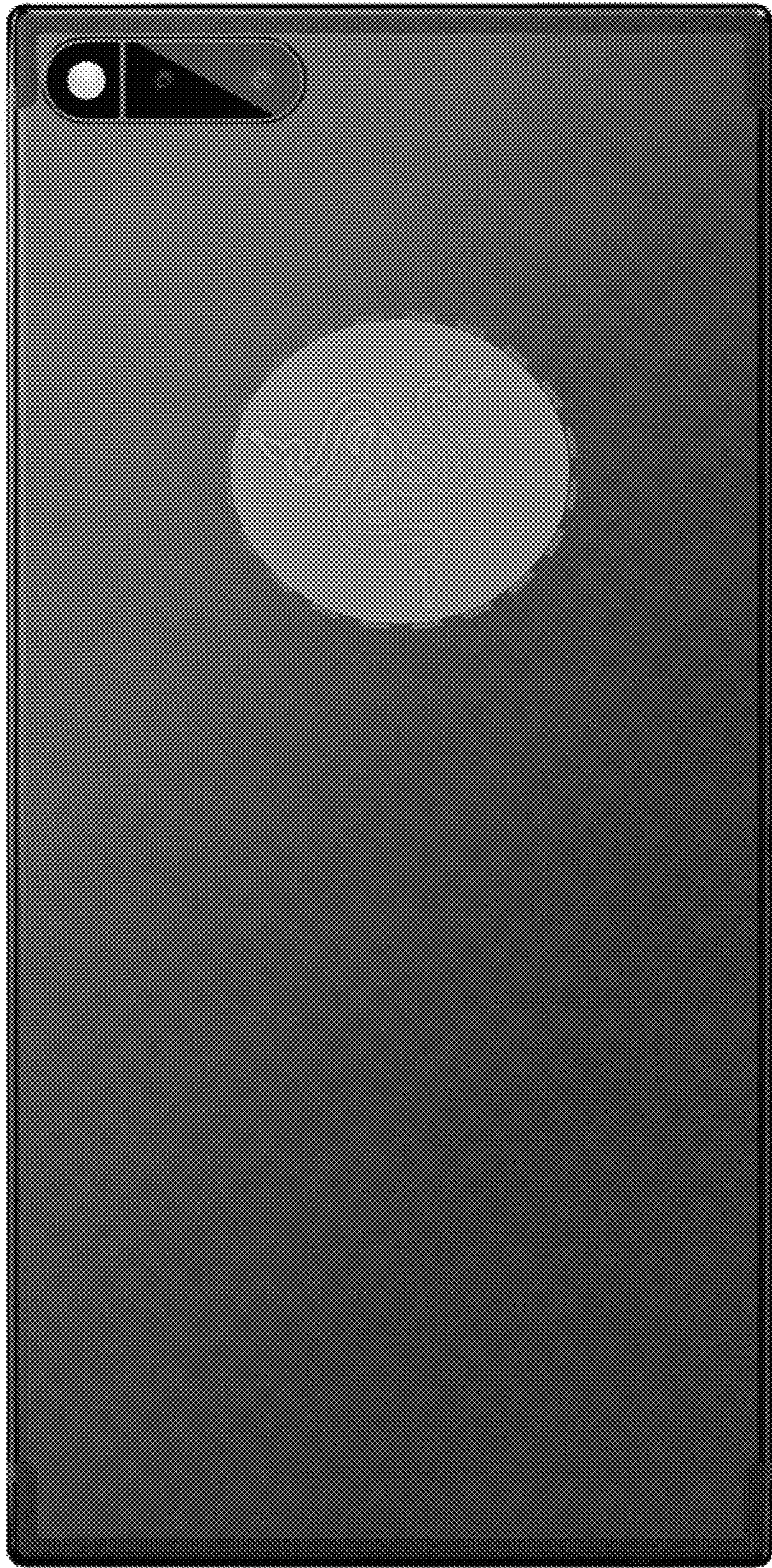

FIG. 16

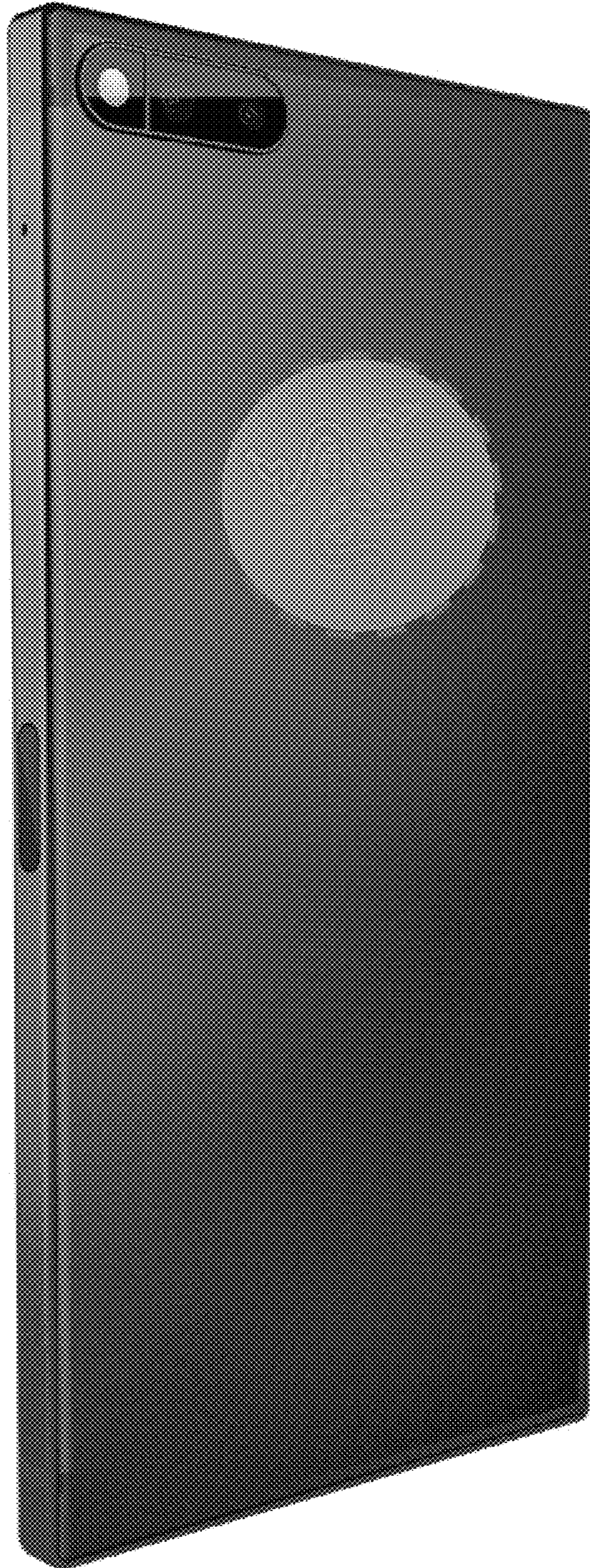

FIG. 17