



US00D851051S

(12) **United States Design Patent**
Ueda

(10) **Patent No.:** **US D851,051 S**
(45) **Date of Patent:** **** Jun. 11, 2019**

- (54) **HEAT SINK**
- (71) Applicant: **SAIJOINX Co., Ltd.**, Kyoto-shi (JP)
- (72) Inventor: **Naoki Ueda**, Kyoto (JP)
- (73) Assignee: **SAIJOINX Co., Ltd.**, Kyoto-shi (JP)
- (**) Term: **15 Years**
- (21) Appl. No.: **29/613,032**
- (22) Filed: **Aug. 7, 2017**

(30) **Foreign Application Priority Data**

Feb. 15, 2017 (JP) 2017-002913

(51) **LOC (11) Cl.** **13-03**

(52) **U.S. Cl.**
USPC **D13/179**

(58) **Field of Classification Search**
USPC D13/179, 122, 182; D26/138, 241, 67,
D26/152
CPC .. H05K 7/20; H05K 7/20172; H05K 7/20127;
H05K 7/20336; H05K 7/202; H05K
7/20272; H01L 23/34; H01L 23/3672;
H01L 23/40; H01L 23/4006; H01L
23/4093; F28D 15/0208; F28D 15/04
See application file for complete search history.

(56) **References Cited**

U.S. PATENT DOCUMENTS

- 3,239,003 A * 3/1966 Boudette B21D 53/02
165/185
- D267,005 S * 11/1982 Dennis D13/179
- D458,232 S * 6/2002 Lee D13/179
- 7,443,678 B2 * 10/2008 Han F21K 9/00
361/704
- D619,550 S * 7/2010 Hwang D13/179
- D620,459 S * 7/2010 Huang D13/179
- D672,730 S * 12/2012 Lin D13/179
- D755,740 S * 5/2016 Chen D13/179
- 9,791,219 B2 * 10/2017 Gamborg F28F 3/04

- D810,034 S * 2/2018 Mira D13/179
- 2005/0199371 A1 * 9/2005 Kemink B23K 1/0012
165/80.3
- 2011/0048675 A1 * 3/2011 Xu H01L 23/3672
165/80.3

OTHER PUBLICATIONS

Robinson Fin, "Plain Radial Aluminum", Accessed Jun. 5, 2018.
(<http://www.robfin.com/plain-folded-fins/plain-radial-aluminum-37/>).*
Saijo, "Folding Fin", Original web page cache from Jun. 10, 2016.
(<https://web.archive.org/web/20160610131301/http://www.saijoinx.com/en/this/foldingfin/>).*

* cited by examiner

Primary Examiner — Jennifer Rivard

Assistant Examiner — April Rivas

(74) *Attorney, Agent, or Firm* — Locke Lord LLP

(57) **CLAIM**

The ornamental design for a heat sink, as shown and described.

DESCRIPTION

FIG. 1 is a front view of the heat sink, with a back view being the same;
FIG. 2 is a top plan view thereof;
FIG. 3 is a right-side view thereof, with a left-side view being the same;
FIG. 4 is a bottom view thereof;
FIG. 5 is an enlarged partial view taken from the indicated area in FIG. 6, thereof;
FIG. 6 is a front view thereof; showing the section where FIG. 5 is taken within broken lines; and,
FIG. 7 is a top perspective view thereof.
The broken lines encircling a section of FIG. 6 are for indicating where the enlarged FIG. 5 view is taken and form no part of the claimed design.

1 Claim, 7 Drawing Sheets

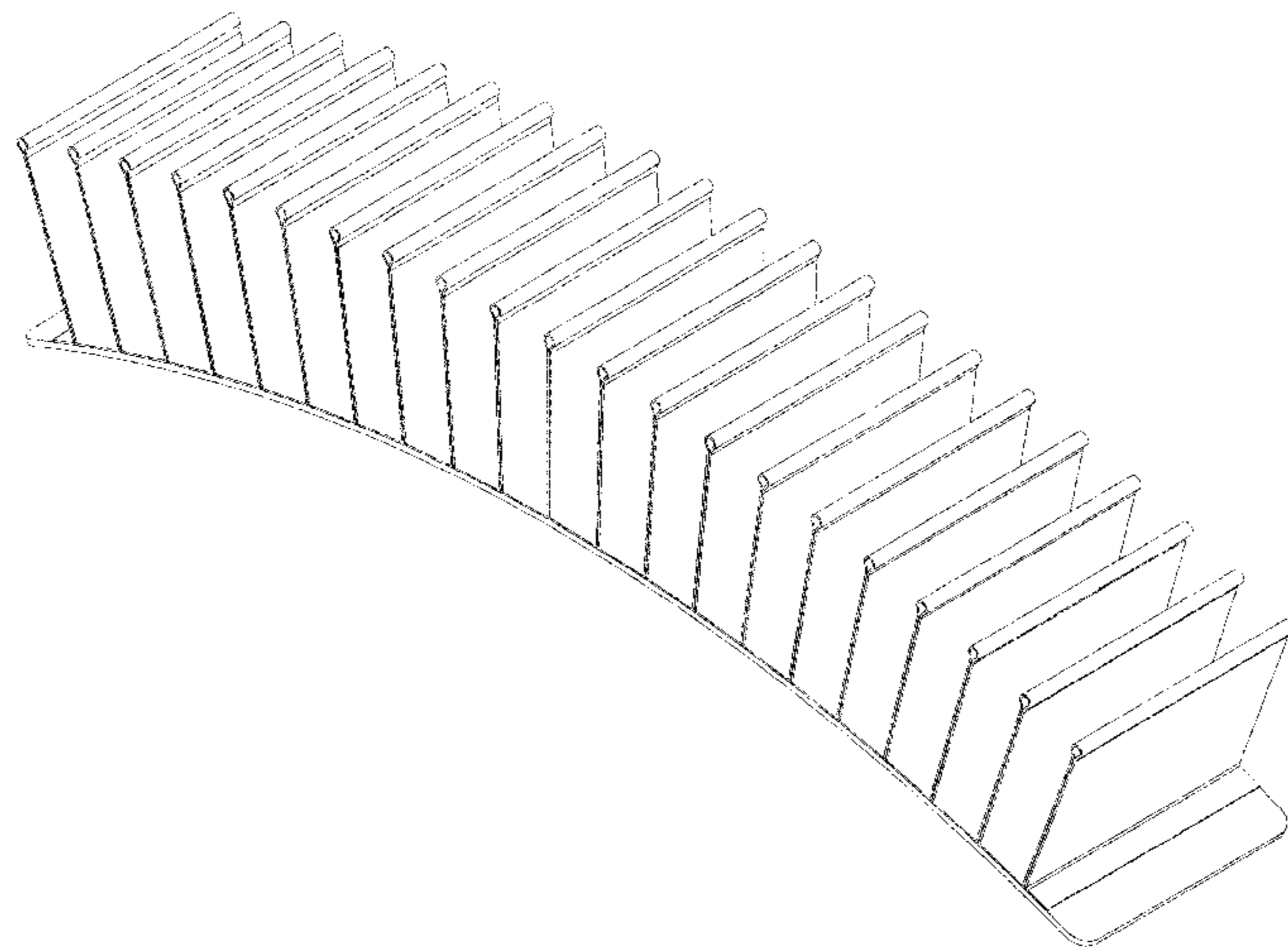

FIG. 1

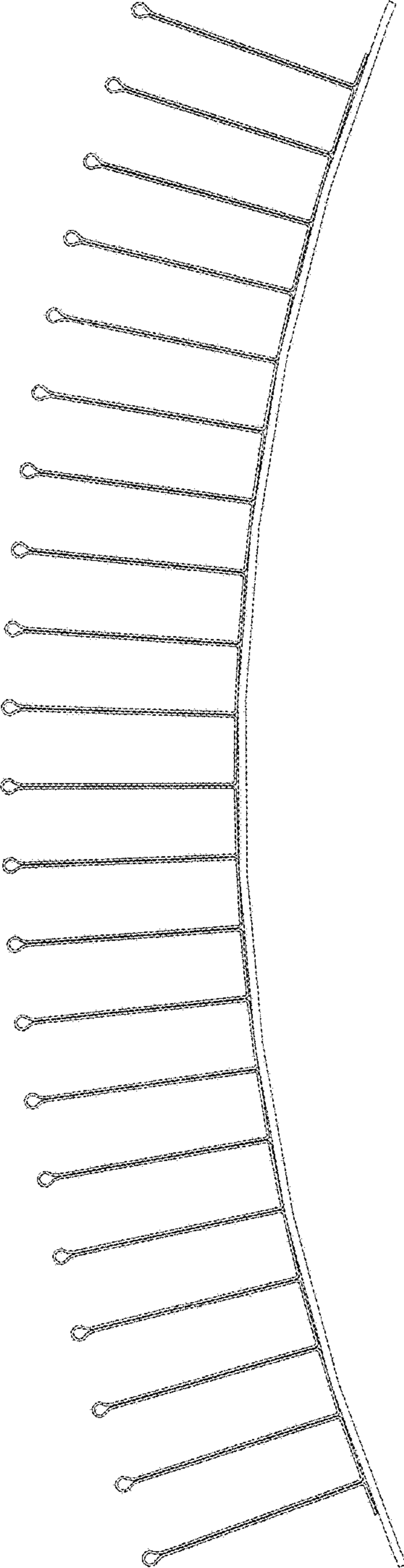

FIG. 2

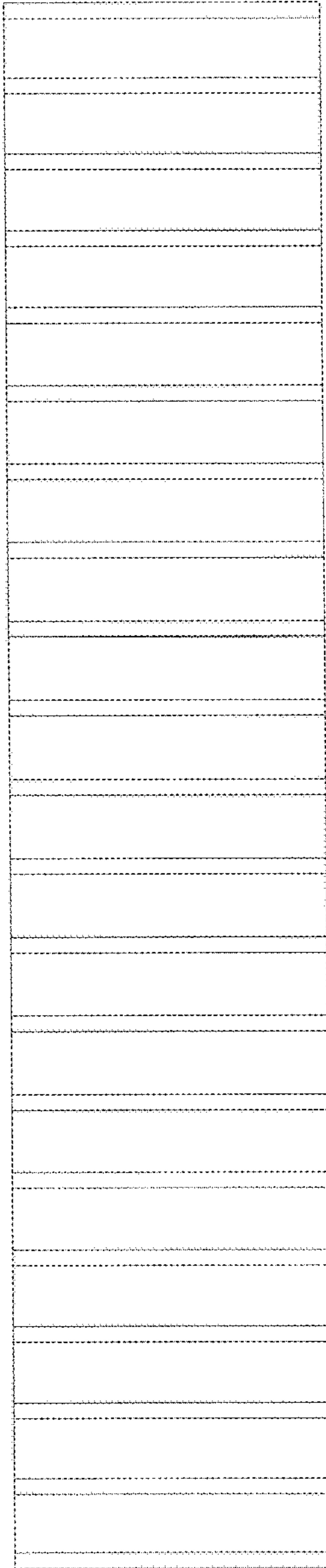

FIG. 3

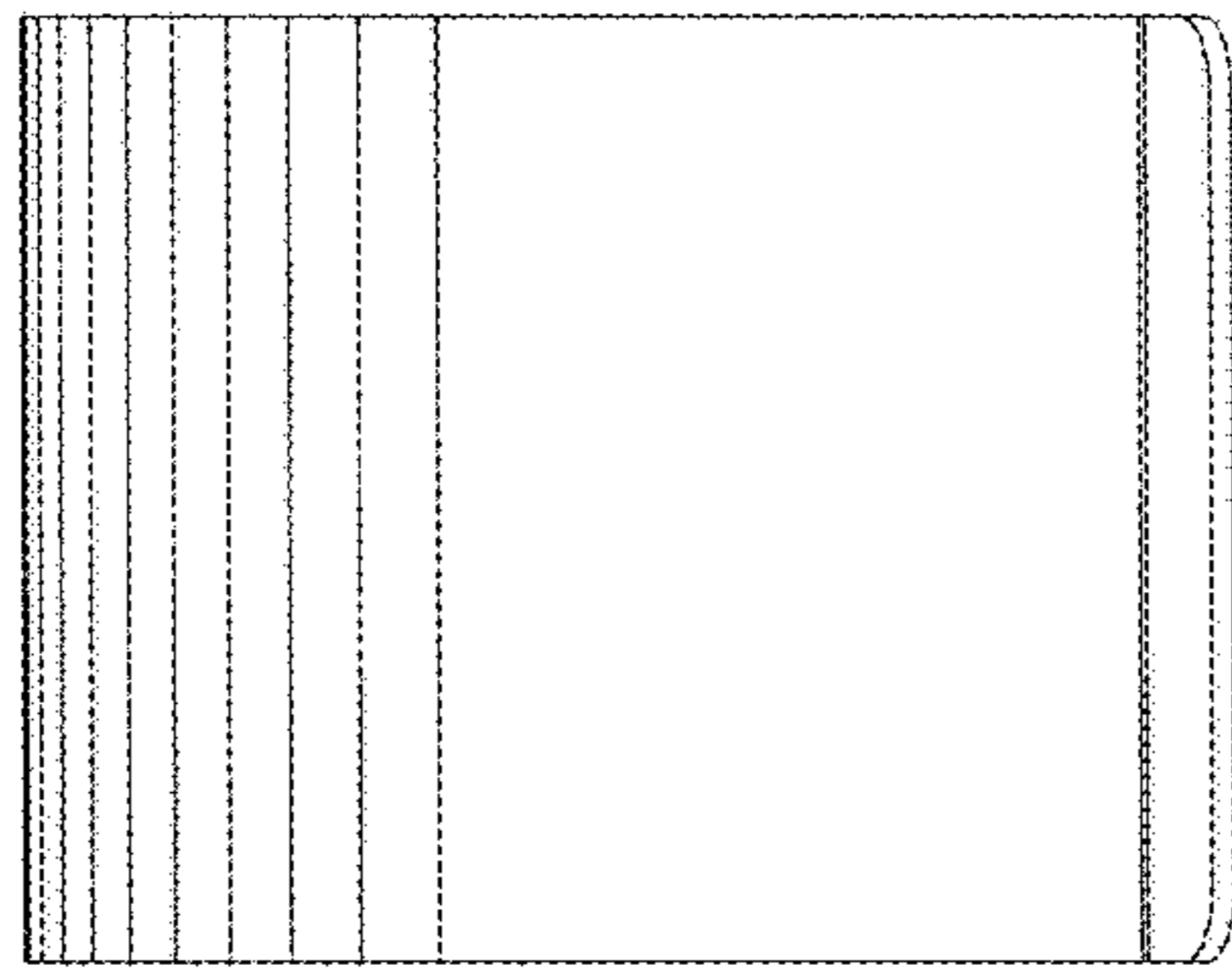
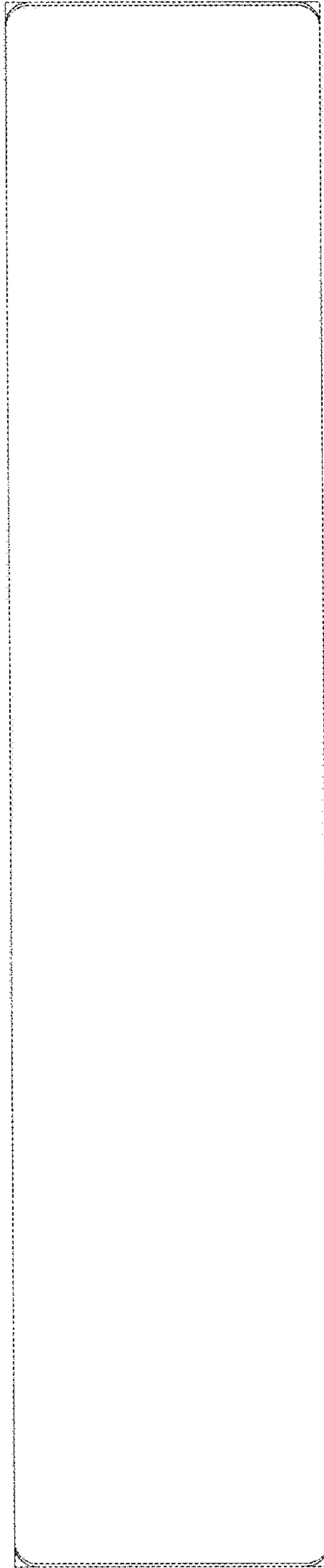

FIG. 4



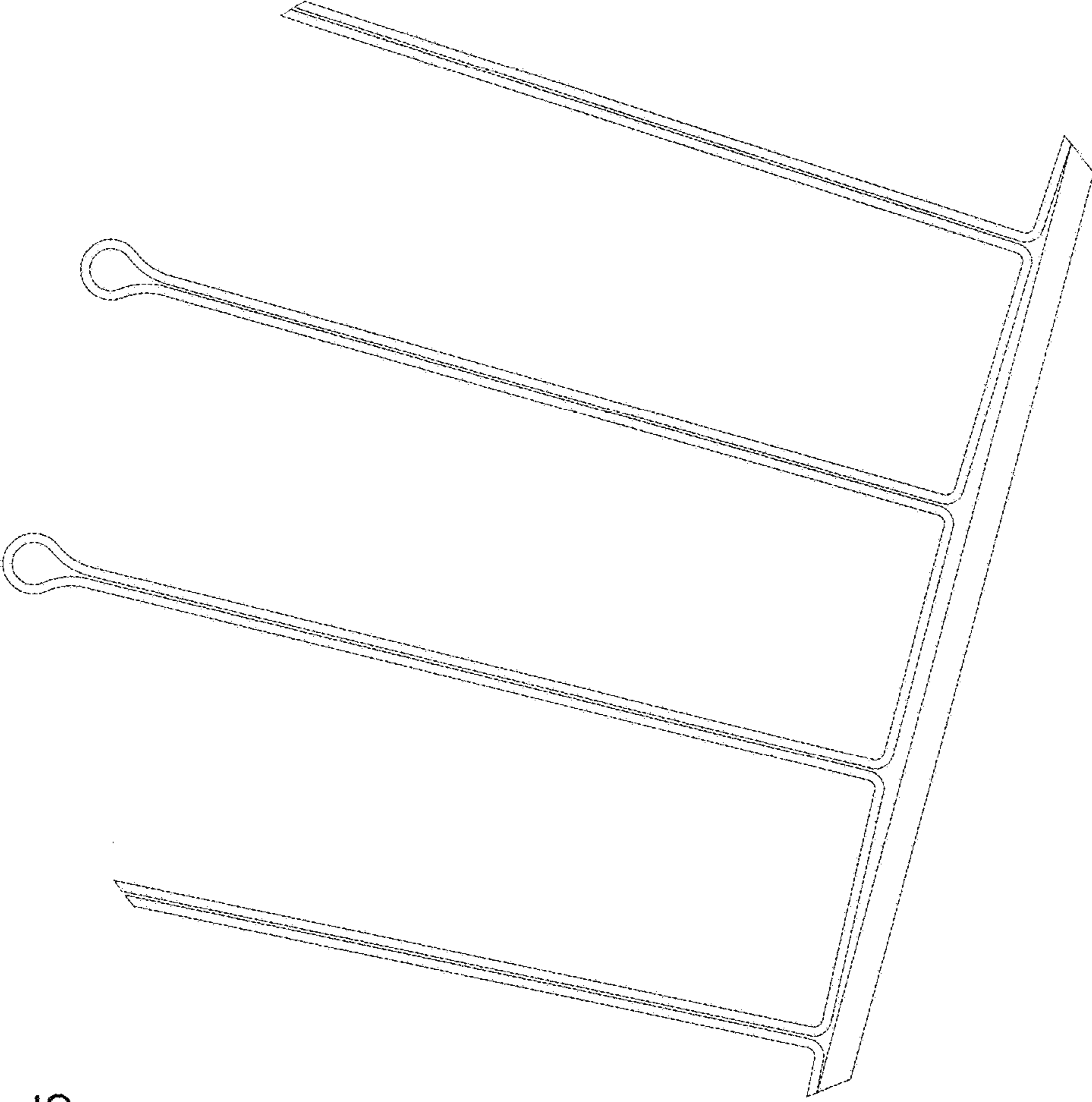

FIG. 5

FIG. 6

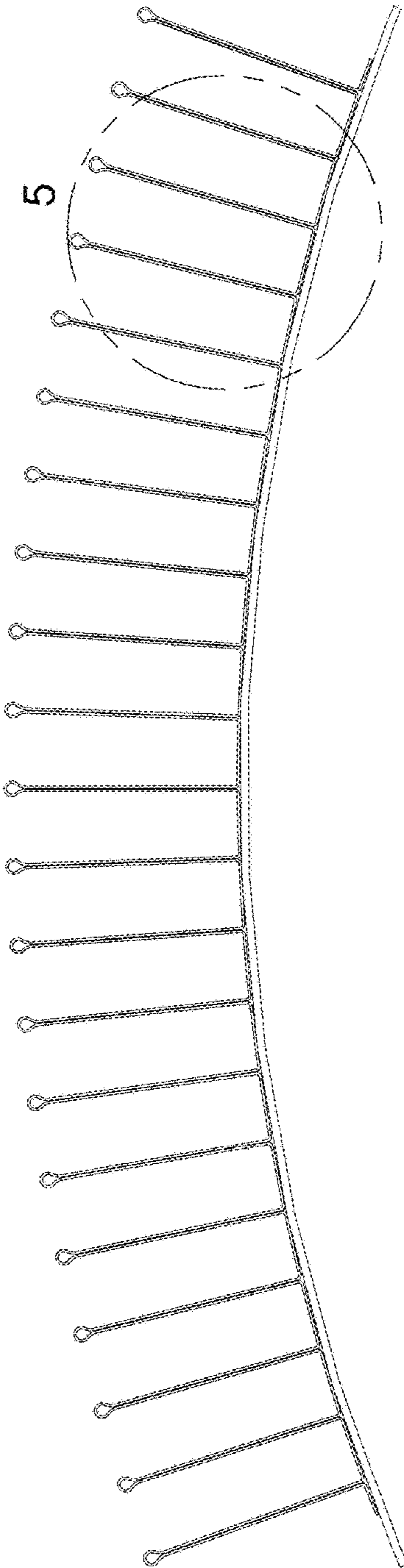

FIG. 7

