

US00D851049S

(12) **United States Design Patent**
Maetani et al.

(10) **Patent No.:** **US D851,049 S**
(45) **Date of Patent:** **** Jun. 11, 2019**

(54) **REMOTE CONTROLLER FOR AIR CONDITIONER**
(71) Applicant: **Mitsubishi Electric Corporation,**
Tokyo (JP)
(72) Inventors: **Noriaki Maetani,** Tokyo (JP); **Yusuke**
Yokosuka, Tokyo (JP); **Yuko**
Fujikawa, Tokyo (JP)
(73) Assignee: **Mitsubishi Electric Corporation,**
Tokyo (JP)
(**) Term: **15 Years**
(21) Appl. No.: **29/630,570**

1,144,487 A * 6/1915 McGinley G09B 19/02
434/203
3,885,794 A * 5/1975 Coffin A63F 9/12
273/160
D307,452 S * 4/1990 Laubscher D21/479
D339,996 S * 10/1993 Rattley D10/104.1
D423,509 S * 4/2000 Park D14/218
D509,534 S * 9/2005 Suzuki D14/248
D546,295 S * 7/2007 Marchetto D13/168
D587,756 S * 3/2009 Rule D19/62
D606,519 S * 12/2009 Painter D14/218
D614,145 S * 4/2010 Arosio D13/168
D632,265 S * 2/2011 Choi D13/168
D647,065 S * 10/2011 Charleux D13/168
D673,512 S * 1/2013 Huang D13/168
D674,441 S * 1/2013 Rule D19/62
D701,841 S * 4/2014 Huang D13/168

(Continued)

(22) Filed: **Dec. 21, 2017**

Primary Examiner — Selina Sikder

(30) **Foreign Application Priority Data**

(74) *Attorney, Agent, or Firm* — Studebaker & Brackett
PC

Jun. 28, 2017 (JP) 2017-013880

(51) **LOC (11) Cl.** **14-03**

(52) **U.S. Cl.**
USPC **D13/168**

(58) **Field of Classification Search**
USPC D13/162, 168; D10/49, 50; D14/218;
D19/62; D21/385, 386, 466, 468, 471,
D21/475, 479, 480, 489, 504, 505
CPC G05D 23/1905; G05D 23/1932; G05D
23/1902; G05D 23/1931; G05B 19/0426;
G05B 19/409; G05B 15/02; G06F
1/1601; G06F 3/041; G06F 3/044; G06F
3/0482; G06F 3/0488; G06F 3/0489;
G02F 1/33308; H01H 9/02; H05B 37/02
See application file for complete search history.

(57) **CLAIM**

The ornamental design for a remote controller for air condi-
tioner, as shown and described.

(56) **References Cited**

DESCRIPTION

FIG. 1 is a front, top and right side perspective view of a
remote controller for air conditioner showing our new
design;
FIG. 2 is a front view thereof;
FIG. 3 is a top view thereof;
FIG. 4 is a bottom view thereof;
FIG. 5 is a left view thereof;
FIG. 6 is a right view thereof; and,
FIG. 7 is reference perspective view showing state in use
thereof.

U.S. PATENT DOCUMENTS

985,253 A * 2/1911 Erickson A63F 9/12
273/160
1,099,009 A * 6/1914 Bennett G09B 19/02
434/203

The parts shown in the broken lines do not form part of the
claimed designs.

1 Claim, 5 Drawing Sheets

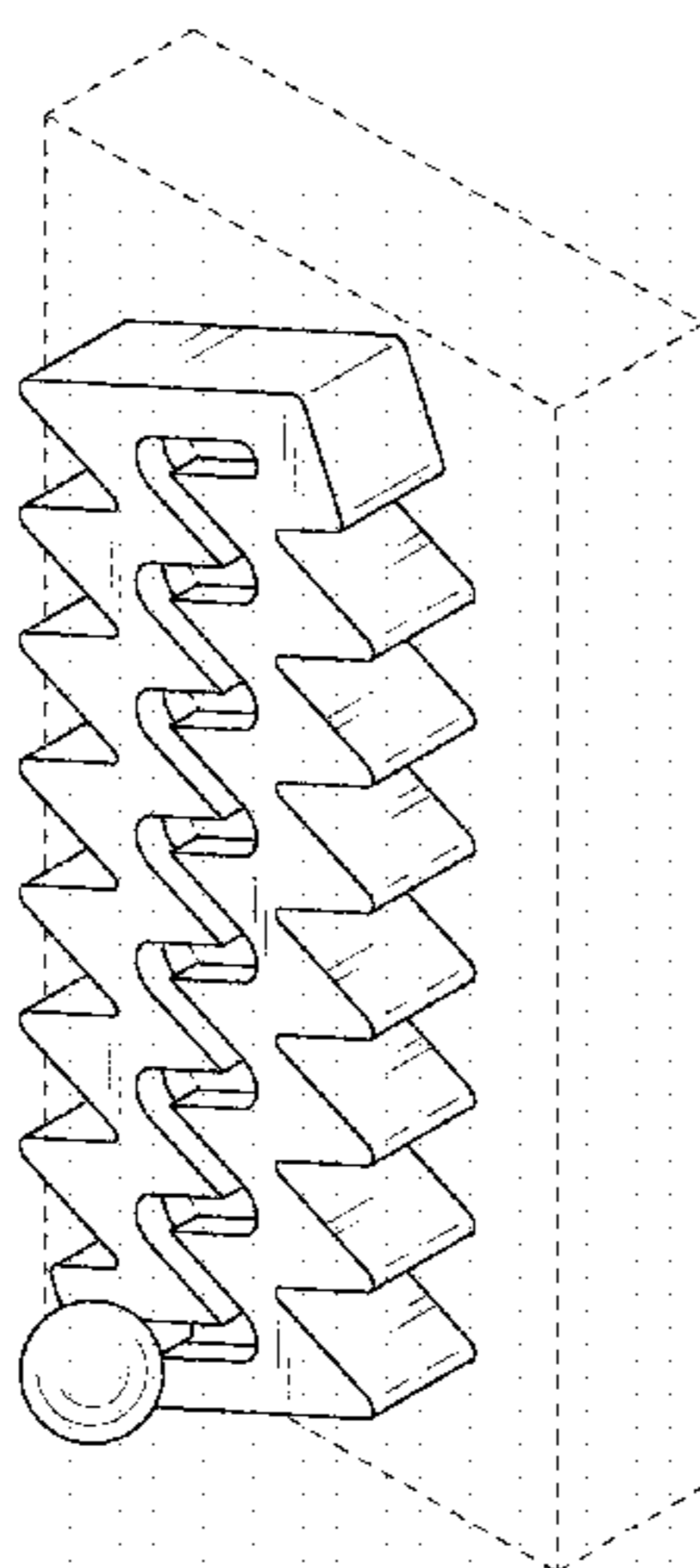

(56)

References Cited

U.S. PATENT DOCUMENTS

D717,743 S * 11/2014 Larkin D13/164
D731,348 S * 6/2015 Vangell D11/11
D740,236 S * 10/2015 Terzoli D13/168
D758,217 S * 6/2016 Kumfer D10/50
D763,204 S * 8/2016 Ikegaya D13/168
D764,418 S * 8/2016 Kashimoto D13/168
D764,419 S * 8/2016 Kashimoto D13/168
D765,053 S * 8/2016 Navarrete D10/104.1
9,423,114 B1 * 8/2016 Malina F21V 23/045
D772,201 S * 11/2016 Lepchenske D14/218
D781,246 S * 3/2017 Zhang D13/162
D808,390 S * 1/2018 Jordan G06F 3/039
D14/388
D813,823 S * 3/2018 Zhang D13/162
2007/0241929 A1 * 10/2007 Marchetto H01H 9/0235
340/13.24
2015/0204561 A1 * 7/2015 Sadwick F24F 11/006
236/1 C
2016/0178230 A1 * 6/2016 Vendt F24F 11/0086
236/1 C
2018/0147913 A1 * 5/2018 Bergin B60H 1/00364

* cited by examiner

Fig. 1

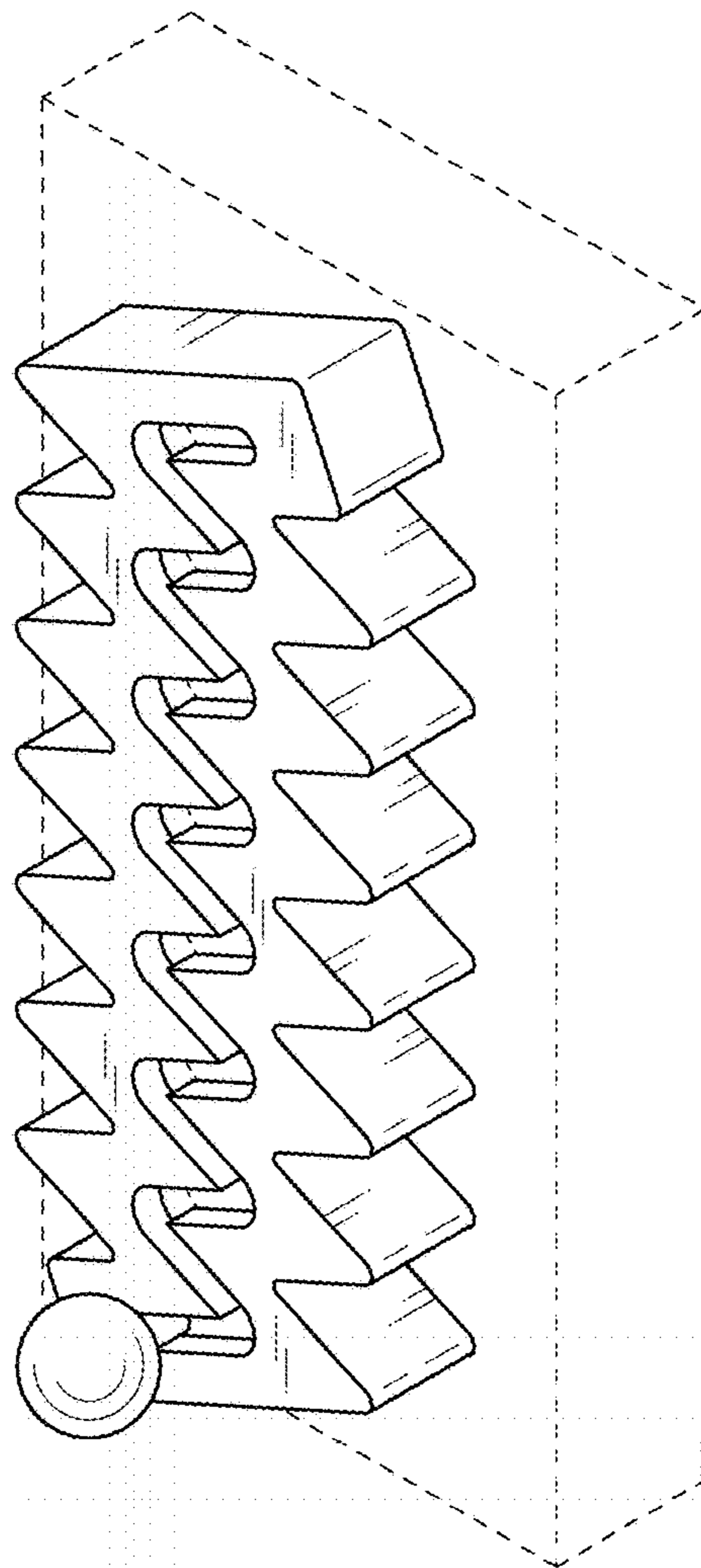

Fig. 2

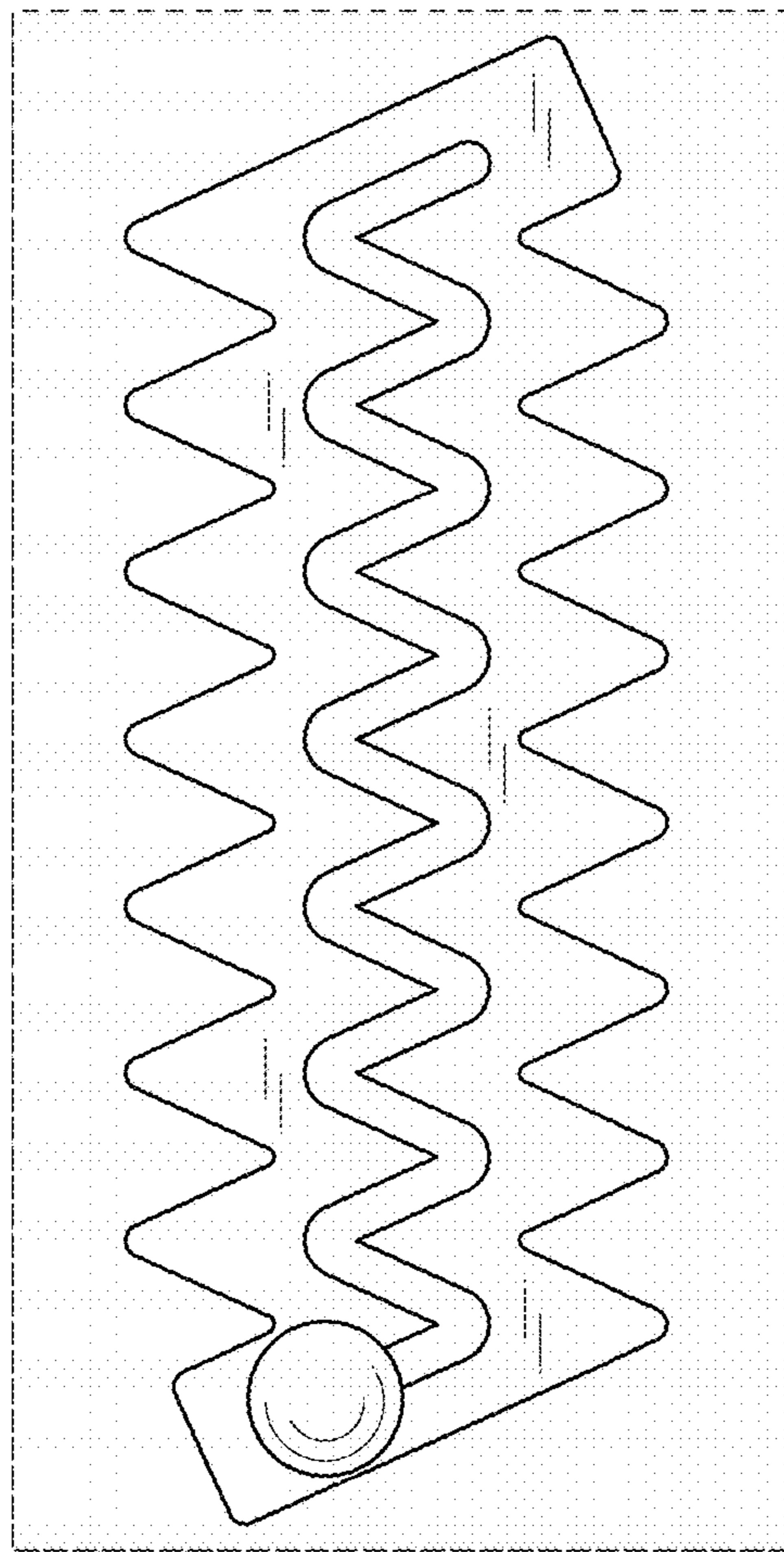

Fig. 3

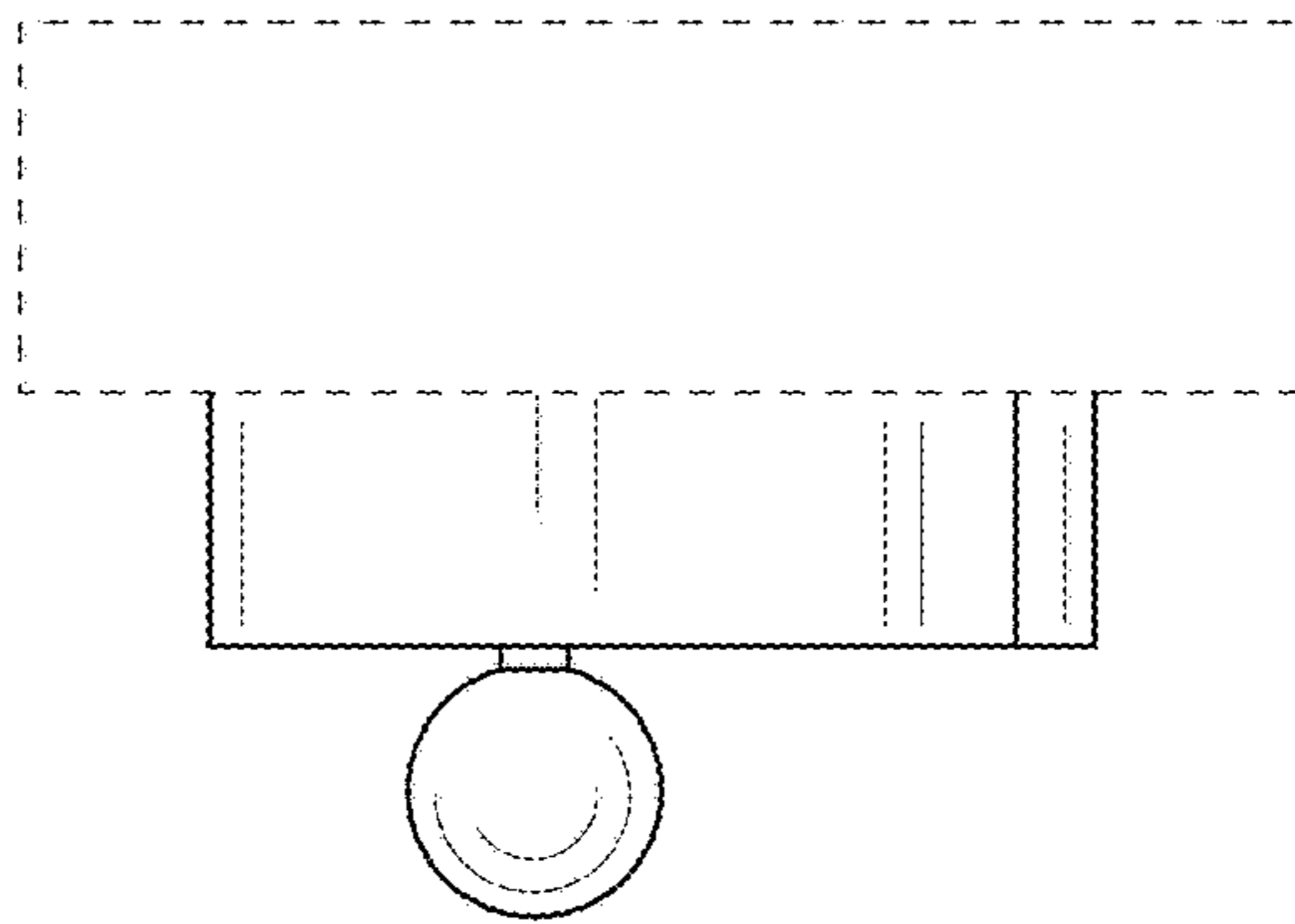

Fig. 4

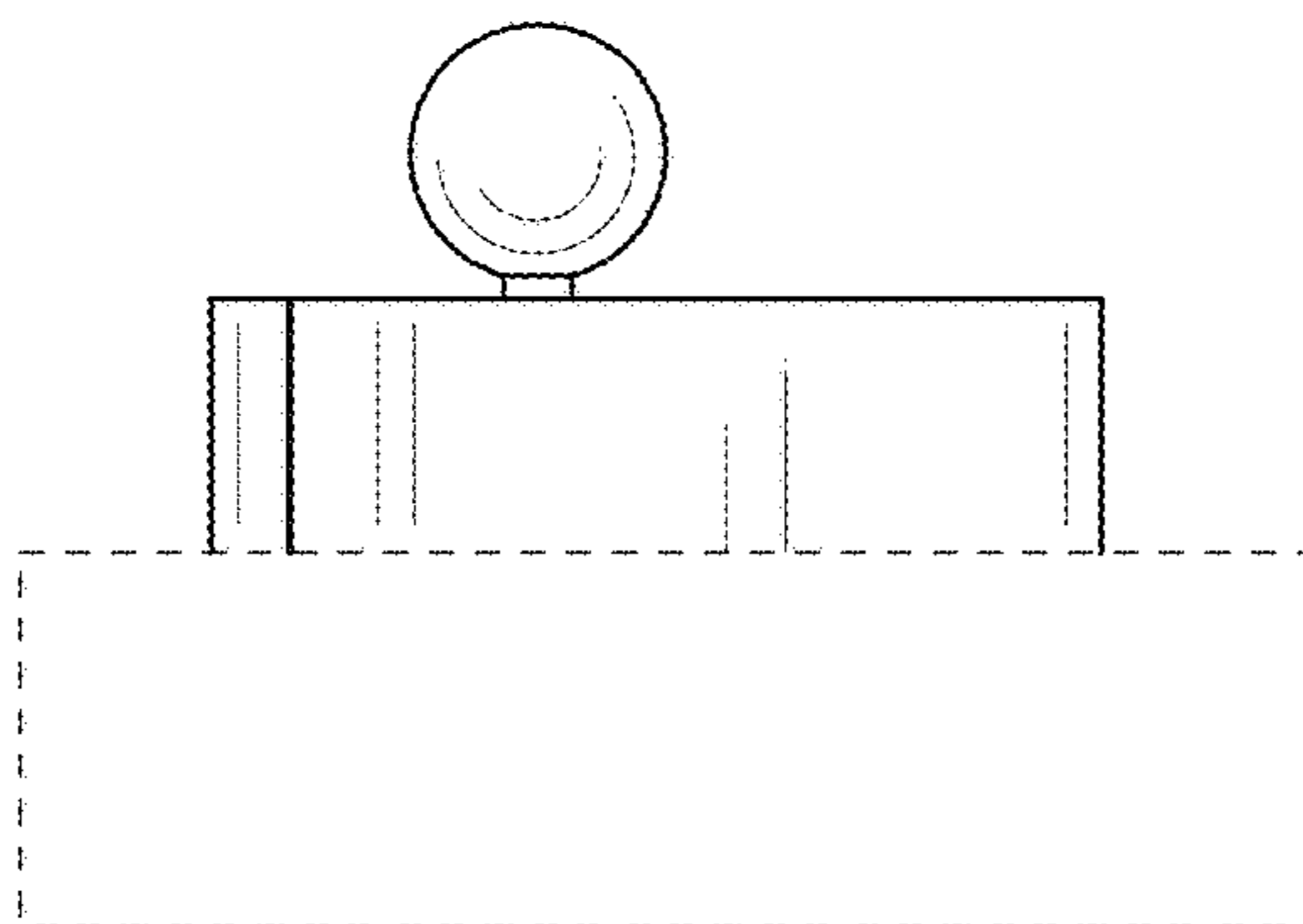

Fig. 5

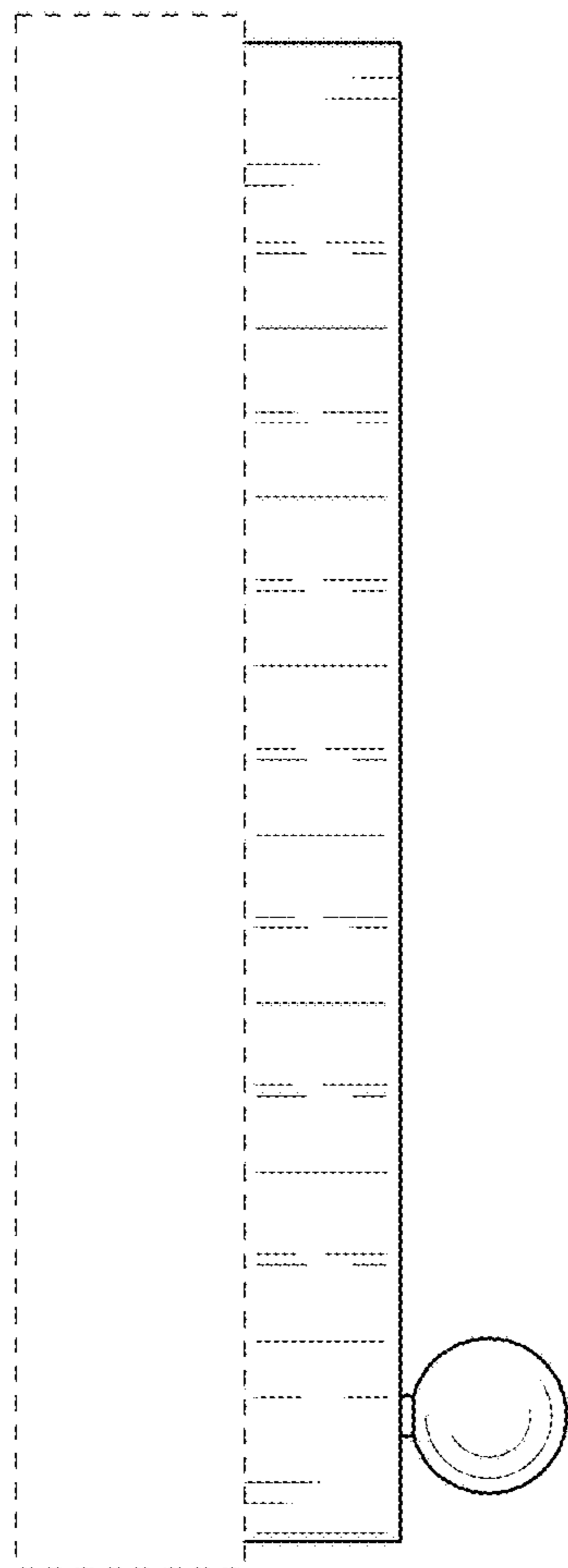

Fig. 6

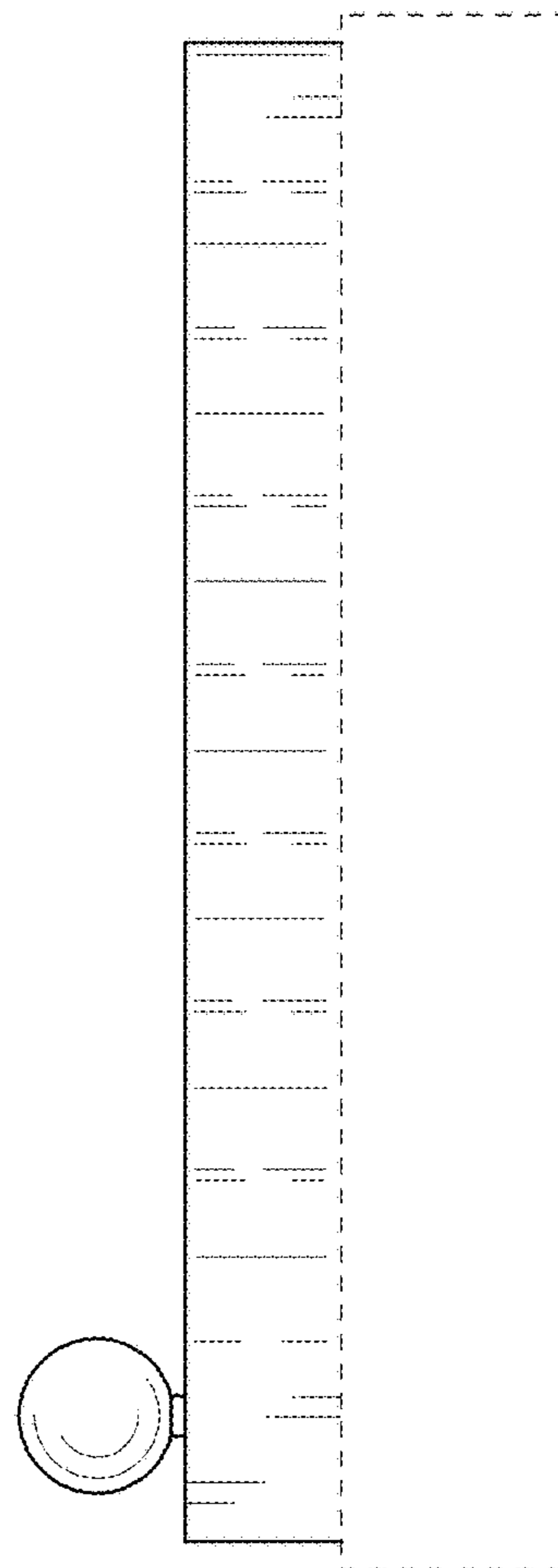

Fig. 7

