



US00D851044S

(12) **United States Design Patent**
Faith et al.

(10) **Patent No.:** **US D851,044 S**
(45) **Date of Patent:** **** Jun. 11, 2019**

(54) **VERTICAL ELECTRICAL CONNECTOR SYSTEM**

(71) Applicant: **Samtec Inc.**, New Albany, IN (US)
(72) Inventors: **Chadrick Paul Faith**, Corydon, IN (US); **Gary Ellsworth Biddle**, Carlisle, PA (US); **Randall Eugene Musser**, Harrisburg, PA (US); **Jonathan Earl Buck**, Hershey, PA (US)
(73) Assignee: **Samtec, Inc.**, New Albany, IN (US)

(**) Term: **15 Years**
(21) Appl. No.: **29/579,623**
(22) Filed: **Sep. 30, 2016**
(51) **LOC (11) Cl.** **13-03**
(52) **U.S. Cl.**
USPC **D13/147**
(58) **Field of Classification Search**
USPC D13/133, 146, 147, 154, 184, 199
(Continued)

(56) **References Cited**

U.S. PATENT DOCUMENTS

D582,859 S * 12/2008 Sasaki D13/147
D582,860 S * 12/2008 Sasaki D13/147
(Continued)

FOREIGN PATENT DOCUMENTS

KR 30-0748546 6/2014
KR 30-0775444 12/2014
(Continued)

OTHER PUBLICATIONS

Samtec, .050 Pitch Terminal Array Assembly, SEAM-XX-XX.X-XX-XX-X-A-XX-K-TR, By: Bratcher, Aug. 9, 2010, 7 sheets.
(Continued)

Primary Examiner — Daniel D Bui
(74) *Attorney, Agent, or Firm* — BakerHostetler

(57) **CLAIM**

The ornamental design for a vertical electrical connector system, as shown and described.

DESCRIPTION

FIG. 1 is a top, left, front perspective view of a vertical electrical connector system, which consists of a first and a second portions in an assembled condition, showing our new design;
FIG. 2 is a bottom, left, rear perspective view thereof;
FIG. 3 is a top, left, rear perspective view thereof;
FIG. 4 is an enlarged top, left, rear perspective view of a portion thereof, as indicated at region FIG. 4 of FIG. 3;
FIG. 5 is a bottom, right, front perspective view of a vertical electrical connector system thereof;
FIG. 6 is an enlarged bottom, right, front perspective view of a portion thereof, as indicated at region FIG. 6 of FIG. 5;
FIG. 7 is a front elevation view of a vertical electrical connector system thereof;
FIG. 8 is a rear elevation view thereof;
FIG. 9 is a top plan view thereof;
FIG. 10 is a bottom plan view thereof;
FIG. 11 is a left side elevation view thereof;
FIG. 12 is a right side elevation view thereof;
FIG. 13 is a top, left, front perspective view of a first portion of a vertical electrical connector system thereof;
FIG. 14 is a bottom, left, rear perspective view thereof;
FIG. 15 is a top, left, rear perspective view thereof;
FIG. 16 is an enlarged top, left, rear perspective view of a portion thereof, as indicated at region FIG. 16 of FIG. 15;
FIG. 17 is a bottom, right, front perspective view of a first portion of a vertical electrical connector system thereof;
FIG. 18 is an enlarged bottom, right, front perspective view of a portion thereof, as indicated at region FIG. 18 of FIG. 17;
FIG. 19 is a rear elevation view of a first portion of a vertical electrical connector system thereof;
FIG. 20 is a front elevation view thereof;
FIG. 21 is a top plan view thereof;
(Continued)

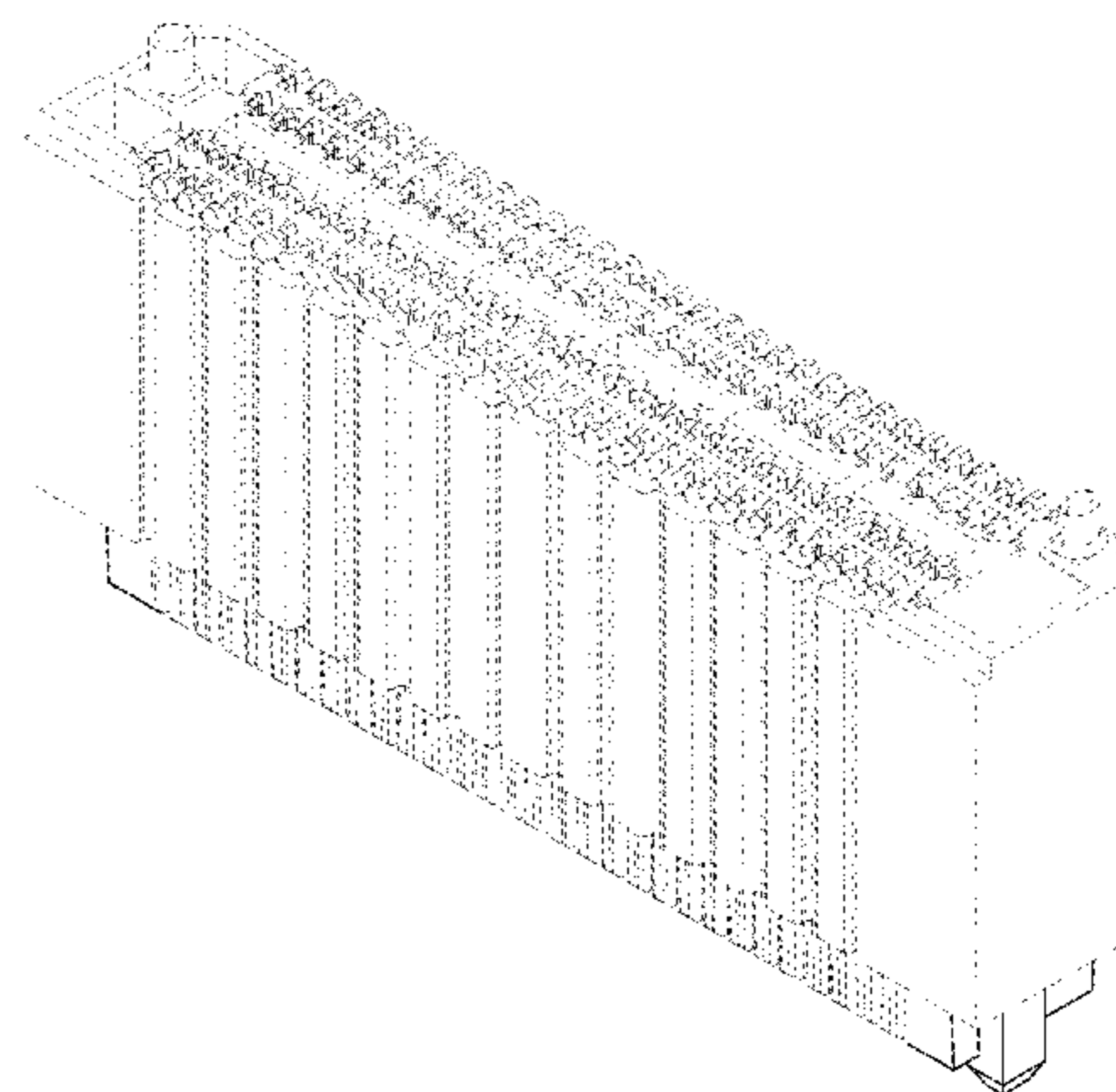
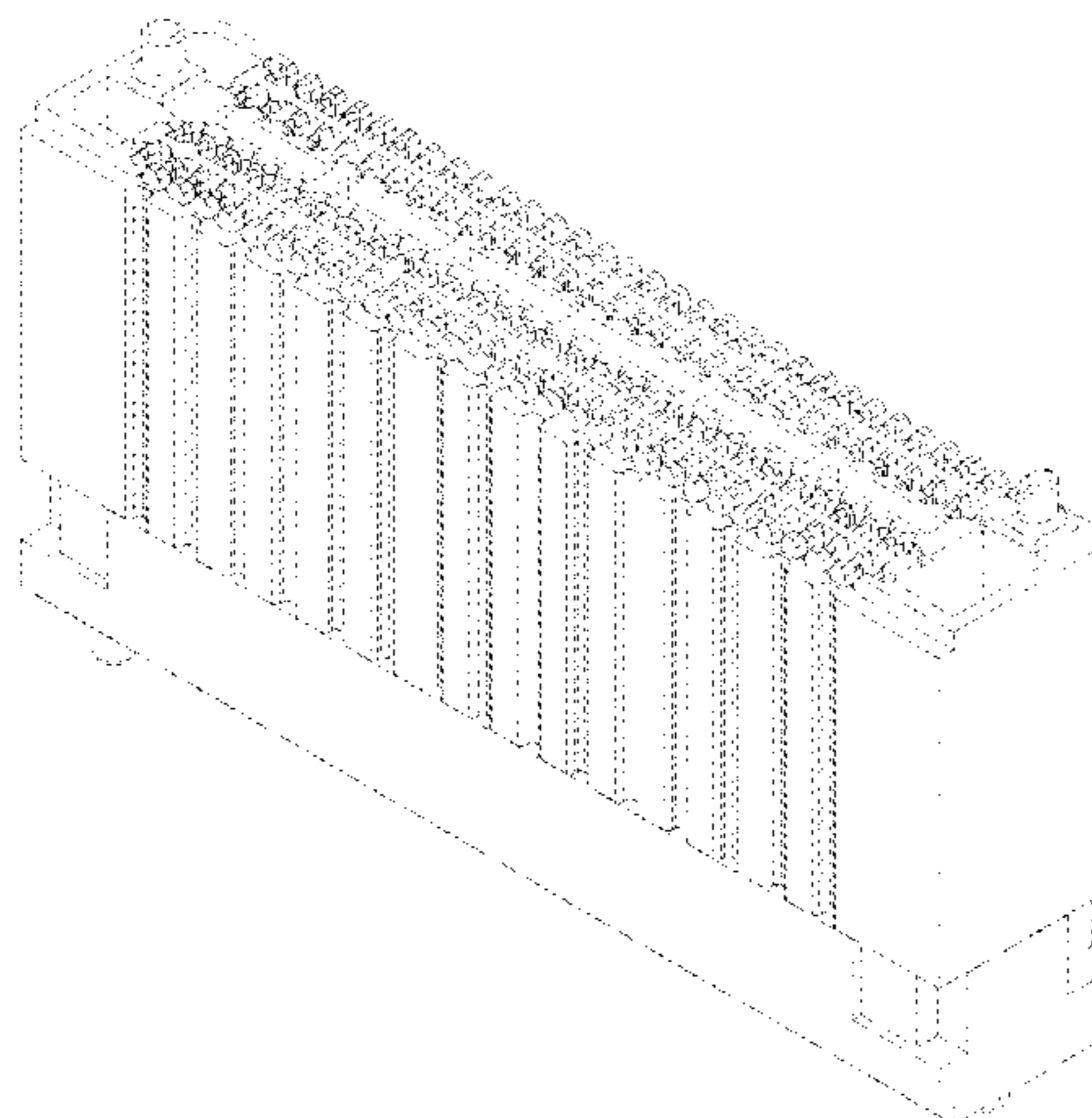

FIG. 22 is a bottom plan view thereof;
 FIG. 23 is a left side elevation view thereof;
 FIG. 24 is right side elevation view thereof;
 FIG. 25 is a top, left, front perspective view of a second portion of a vertical electrical connector system thereof;
 FIG. 26 is an enlarged top, left, front perspective view of a portion thereof, as indicated at region FIG. 26 of FIG. 25;
 FIG. 27 is a bottom, right, front perspective view of a second portion thereof;
 FIG. 28 is an enlarged bottom, right, front perspective view of a portion thereof, as indicated at region FIG. 28 of FIG. 27;
 FIG. 29 is a top, left, rear perspective view of a second portion thereof;
 FIG. 30 is an enlarged top, left, rear perspective view of a portion thereof, as indicated at region FIG. 30 of FIG. 29;
 FIG. 31 is a bottom, right, front perspective view of a second portion thereof;
 FIG. 32 is an enlarged bottom, right, front perspective view of a portion thereof, as indicated at the region FIG. 32 of FIG. 31;
 FIG. 33 is a rear elevation view of a second portion thereof;
 FIG. 34 is a front elevation view thereof;
 FIG. 35 is a top plan view thereof;
 FIG. 36 is a bottom plan view thereof;
 FIG. 37 is a left side elevation view thereof; and,
 FIG. 38 is a right side elevation view thereof.
 The broken line portion of the figure drawings is included to show unclaimed subject matter only for the purpose of illustrating environment and forms no part of the claimed design.
 The dash-dot line represents the boundary of the claimed design.

1 Claim, 18 Drawing Sheets

(58) **Field of Classification Search**

CPC H01R 12/7052; H01R 12/7076;
 H01R 12/73; H01R 13/20; H01R
 13/6271; H01R 13/6272; H01R 13/629;

H01R 13/631; H01R 13/64; H01R
 13/658; H01R 13/65802; H01R 13/6581;
 H01R 12/57; H01R 12/7005; H01R
 12/7011; H01R 12/716; H01R 12/7029;
 H01R 12/707; H01R 12/721; H01R
 12/737

See application file for complete search history.

(56)

References Cited

U.S. PATENT DOCUMENTS

D598,861	S	*	8/2009	Hoshino	D13/147
D635,516	S		4/2011	Faith		
D659,646	S	*	5/2012	Kajiura	H01R 12/77 D13/154
D678,843	S		3/2013	Faith		
D708,580	S	*	7/2014	McCartin	D13/147
8,784,116	B2		7/2014	Buck et al.		
D710,310	S		8/2014	McCartin et al.		
D718,245	S	*	11/2014	Sato	D13/147
9,300,103	B2		3/2016	Buck et al.		
2012/0252232	A1		10/2012	Buck et al.		
2014/0310957	A1		10/2014	Buck et al.		

FOREIGN PATENT DOCUMENTS

KR	30-0856264	5/2016
TW	D149636	10/2012
TW	D151642	2/2013
TW	D151999	2/2013
TW	D157156	11/2013
TW	D159829	4/2014
TW	D167749	5/2015
TW	D171256	10/2015
TW	D172199	12/2015
TW	D172409	12/2015
WO	WO 2012/138519 A2	10/2012

OTHER PUBLICATIONS

Samtec, .050 Pitch Socket Array Assembly, SEAF-XX-XX.X-XX-XX-X-A-XX-K-TR, By: Bratcher, May 27, 2004, 5 sheets.
 Taiwanese Patent Application No. 107303227: Notice of Allowance dated Oct. 30, 2018, 4 pages.

* cited by examiner

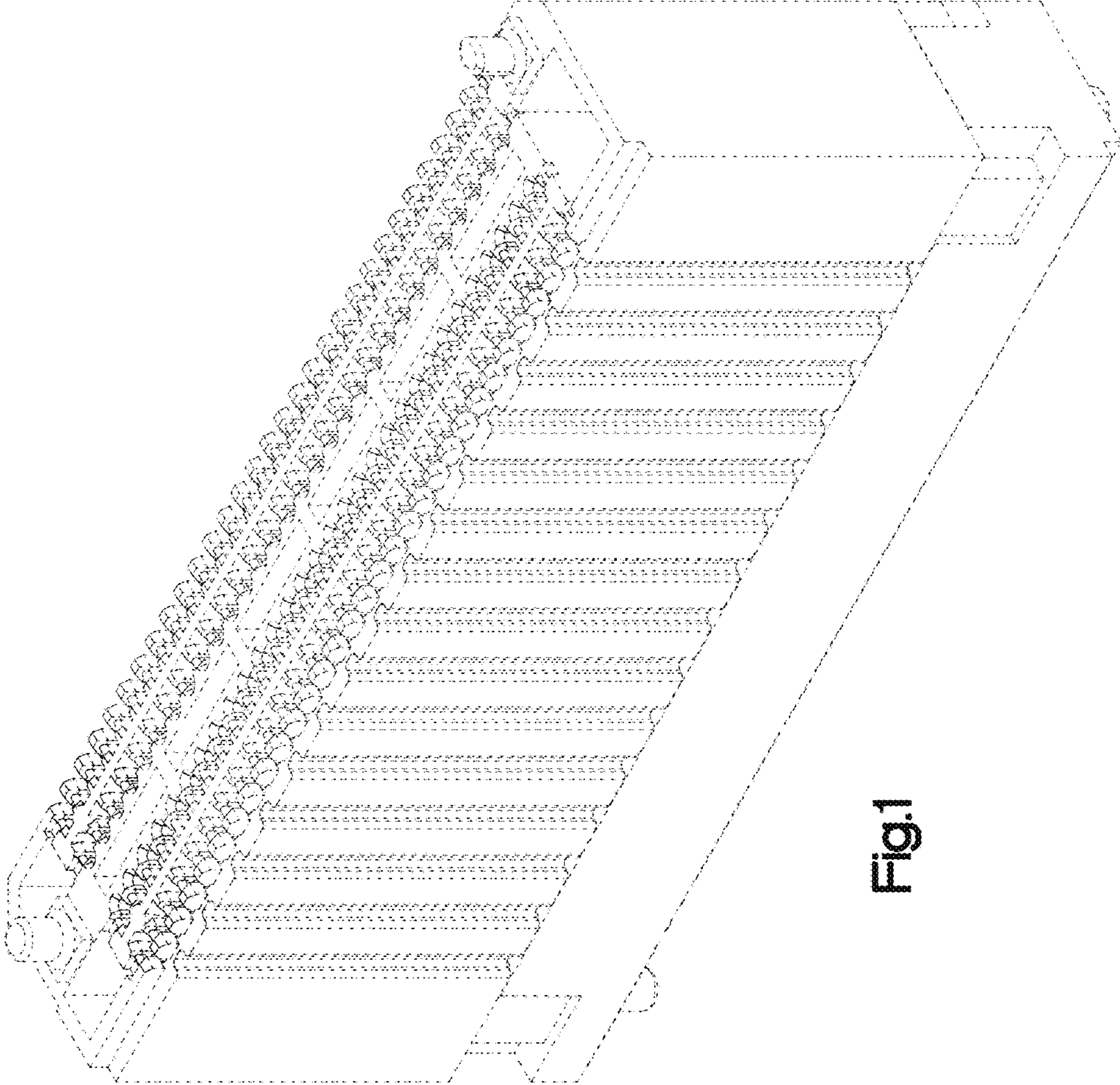

Fig.1

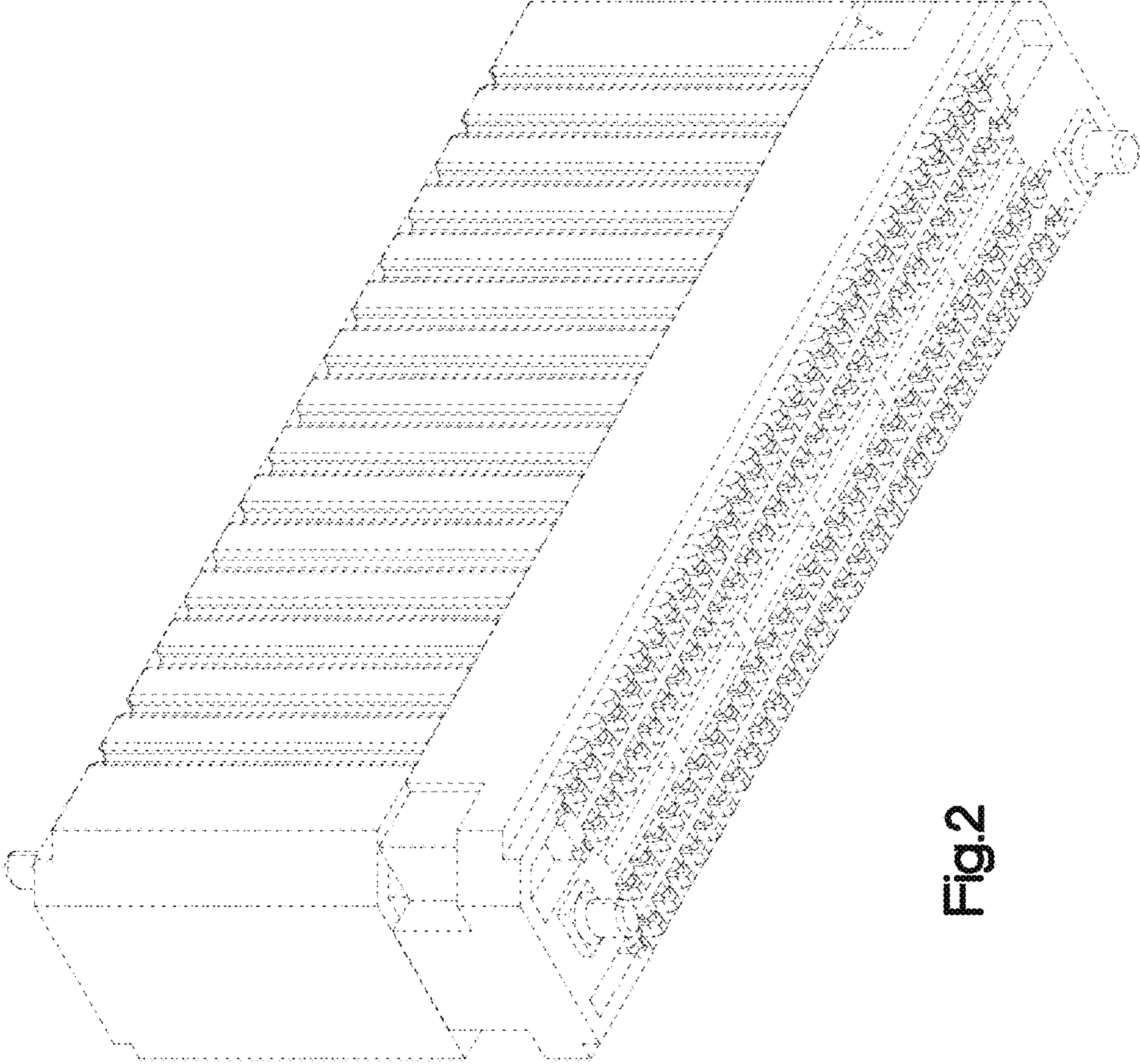
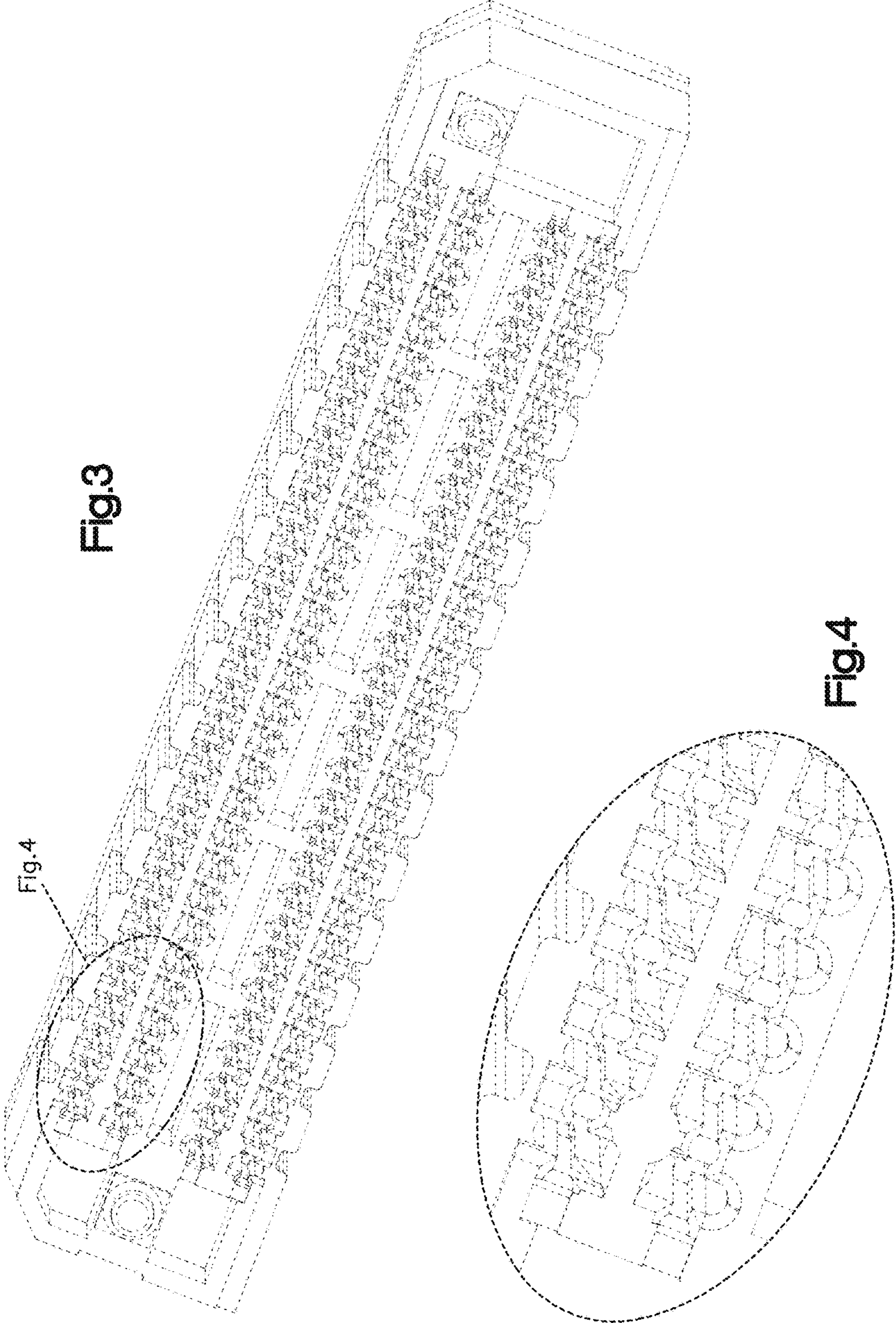

Fig.2



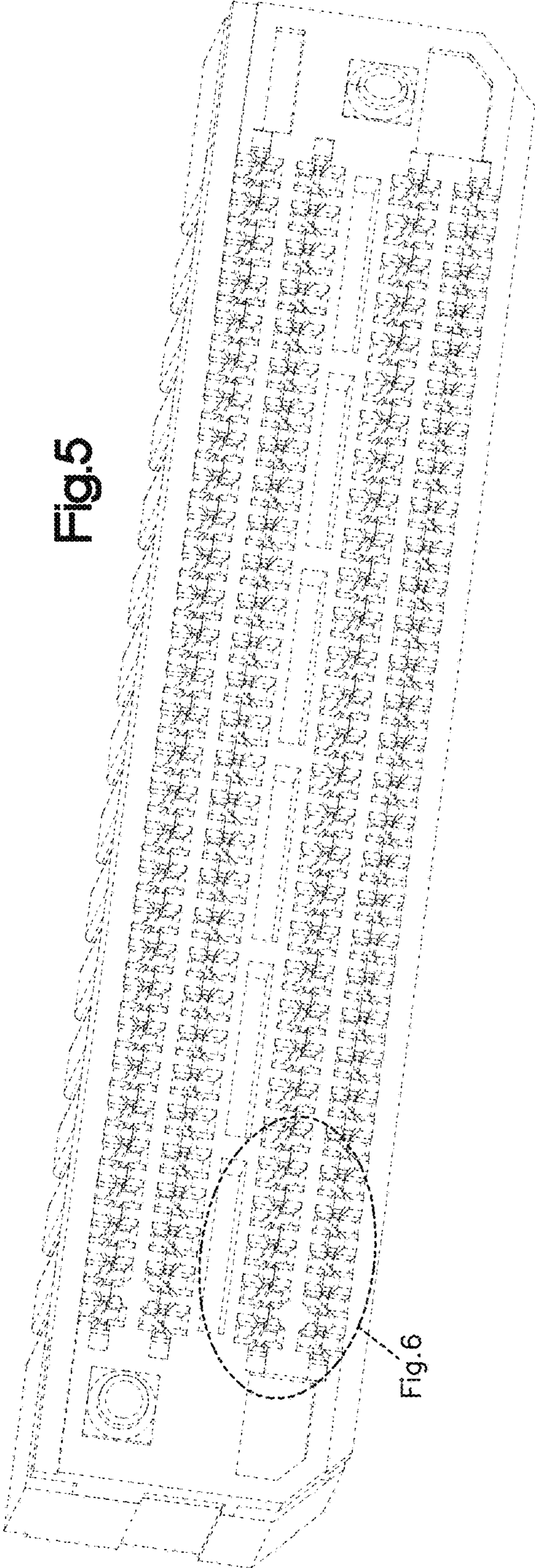

Fig. 5

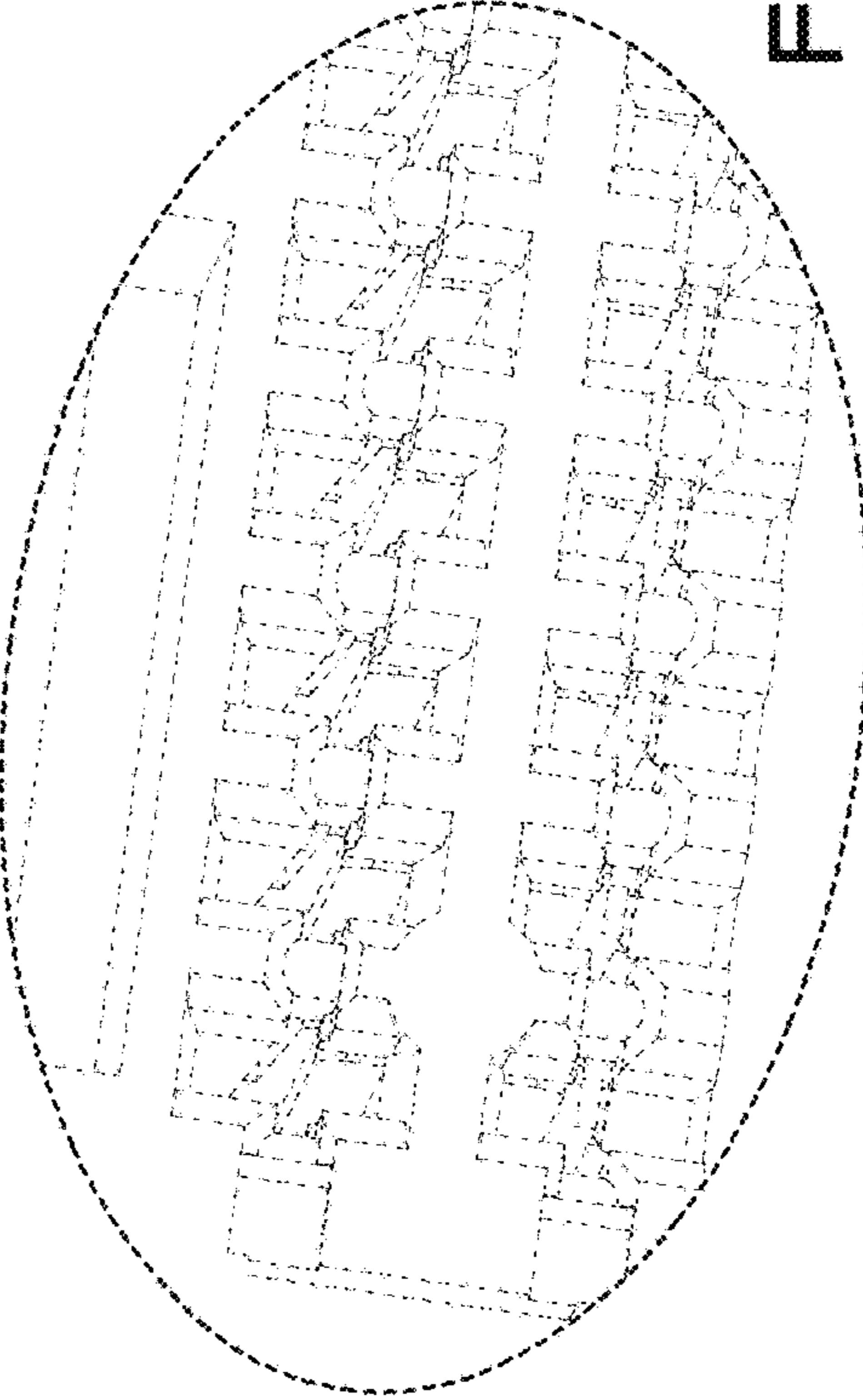

Fig. 6

Fig. 6



Fig.7

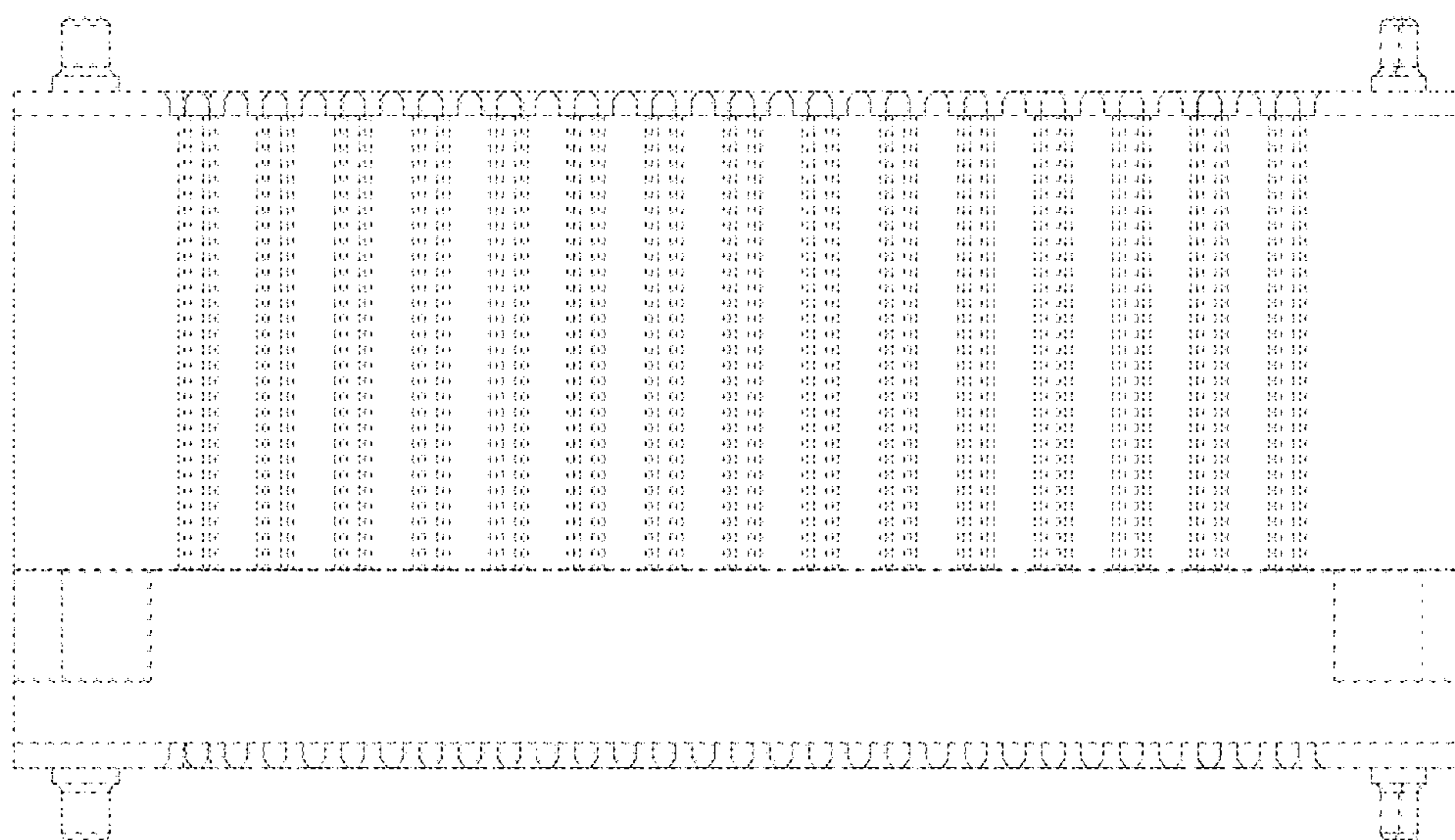

Fig.8

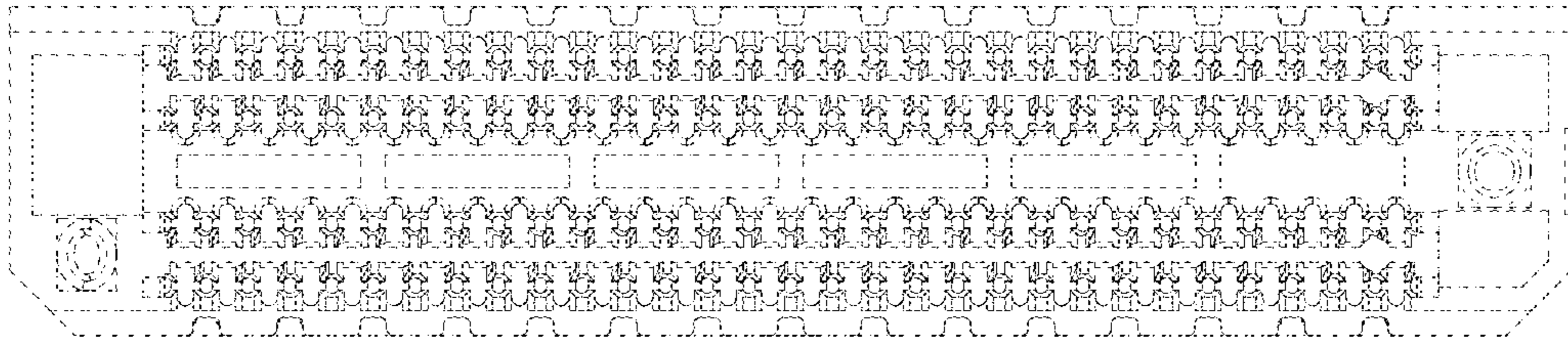

Fig.9

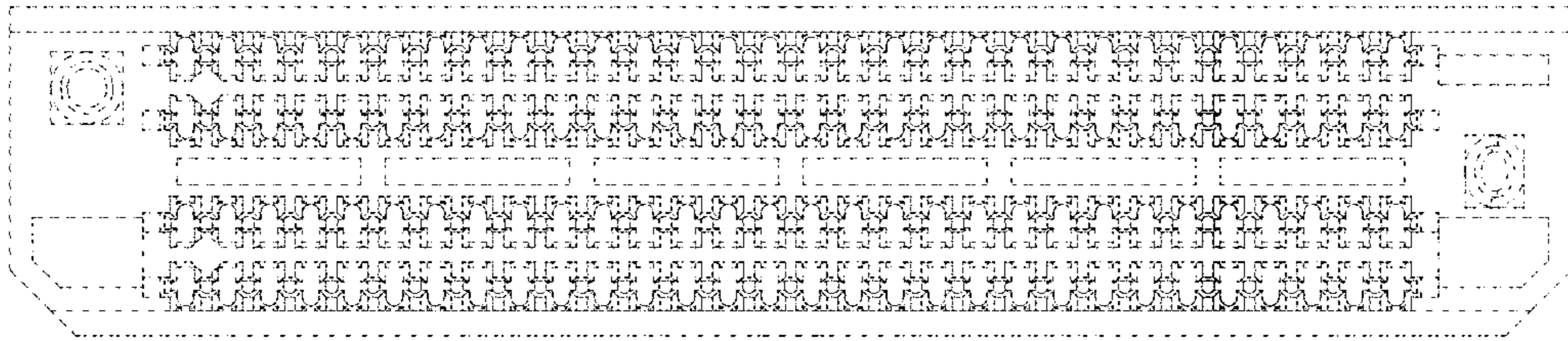

Fig.10

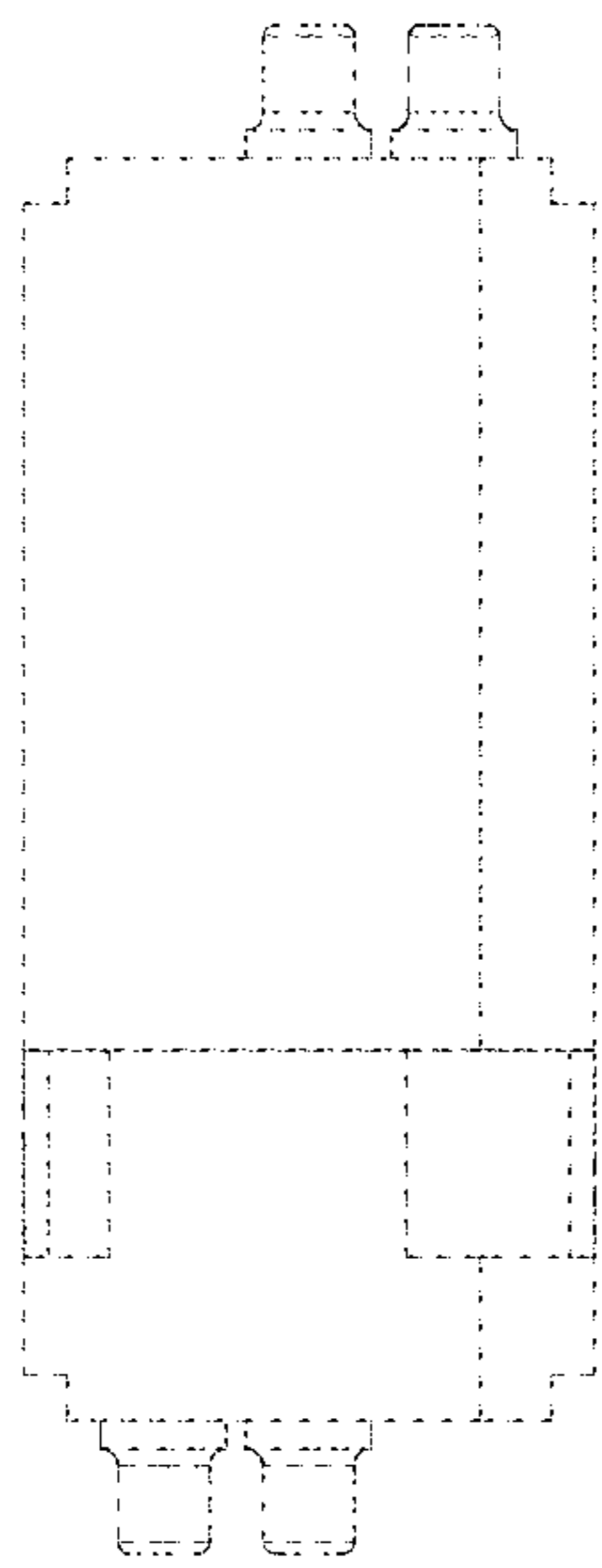

Fig.11

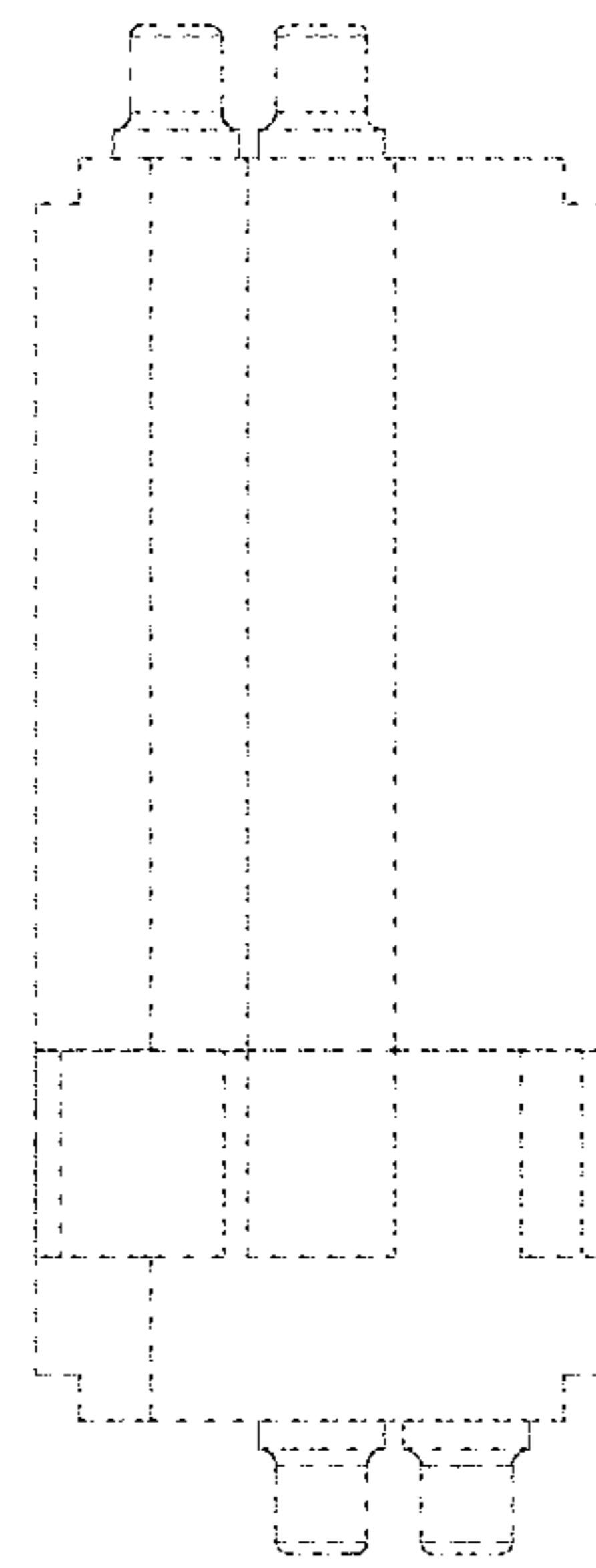

Fig.12

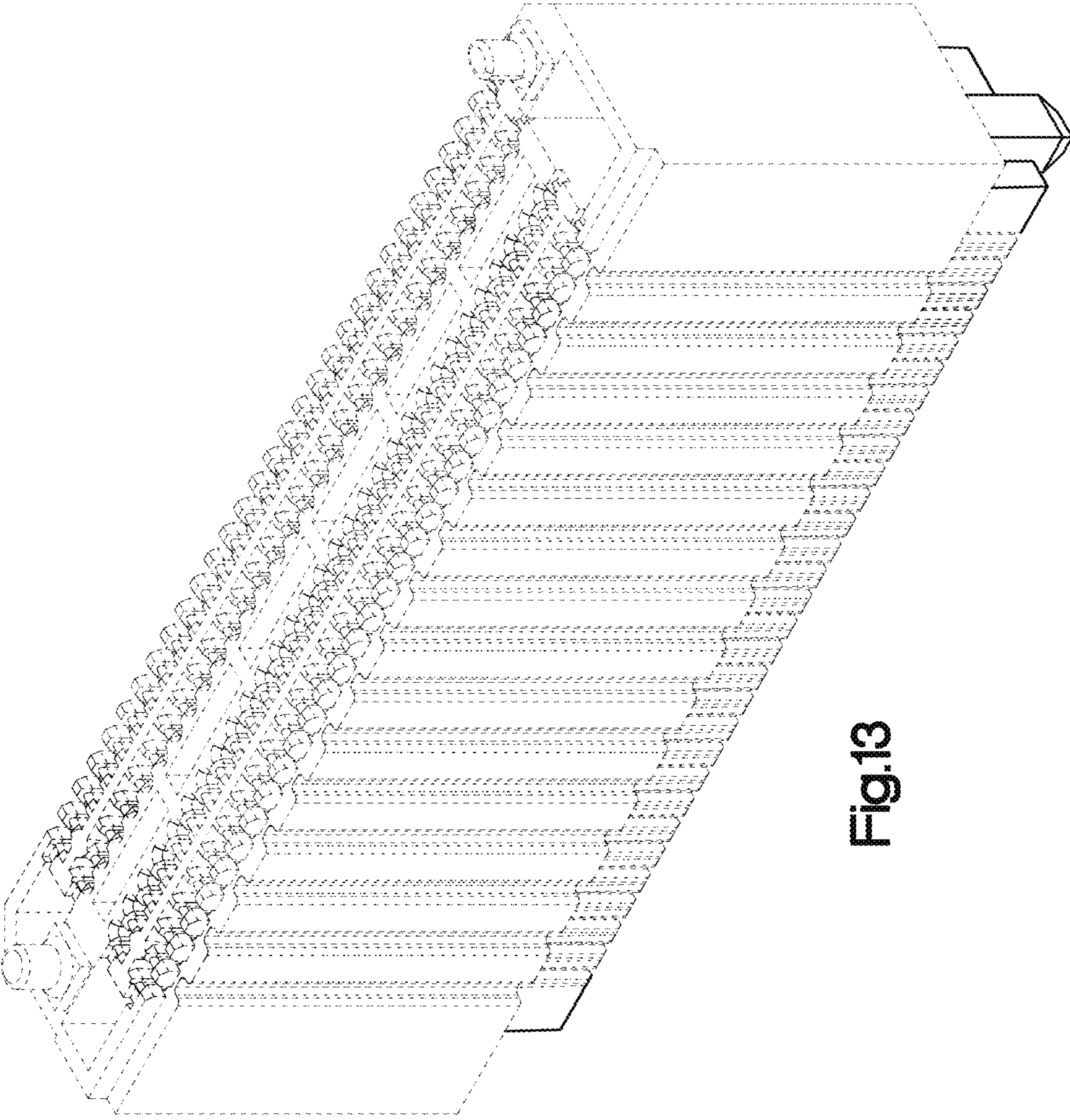

Fig.13

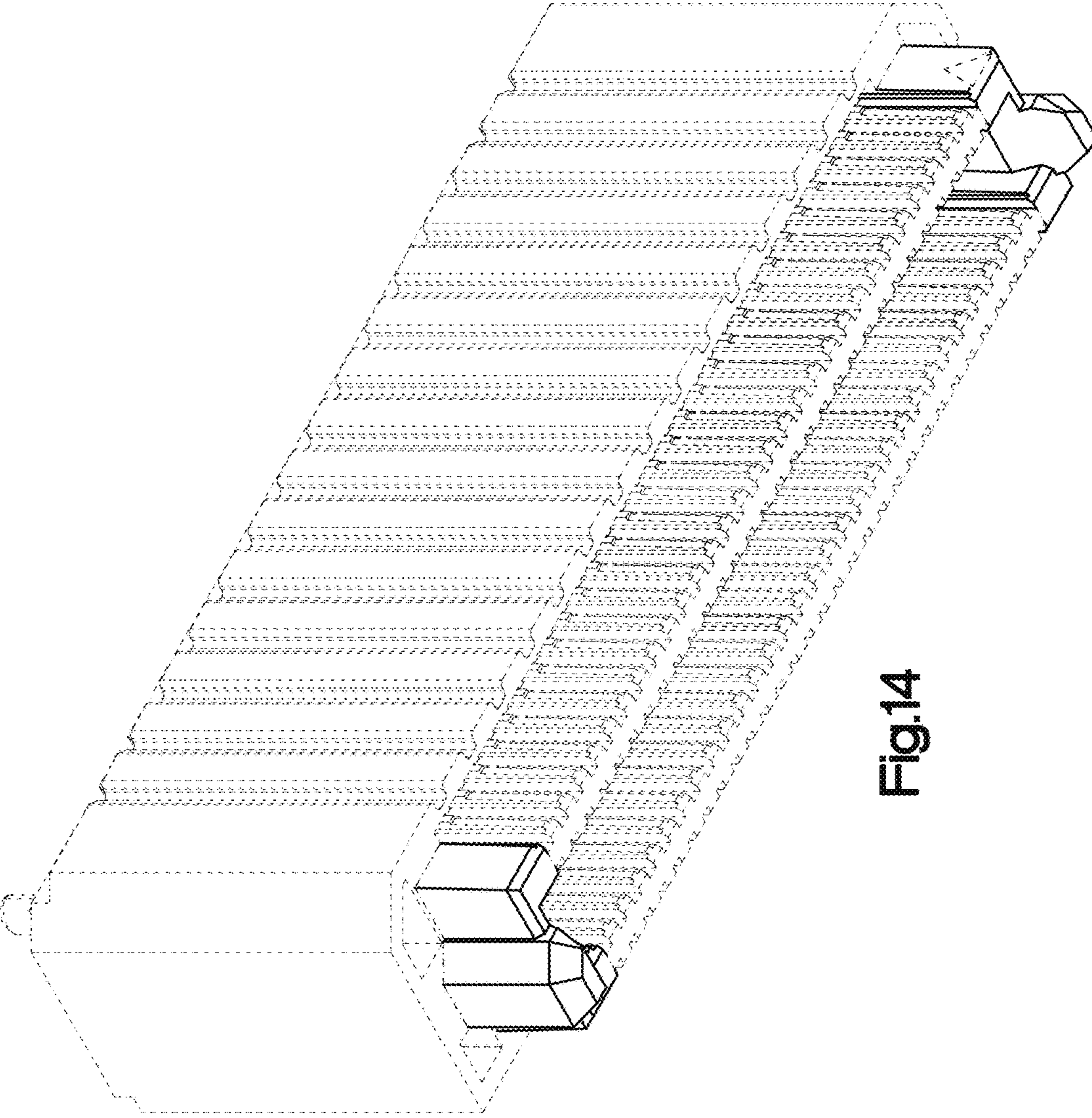

Fig.14

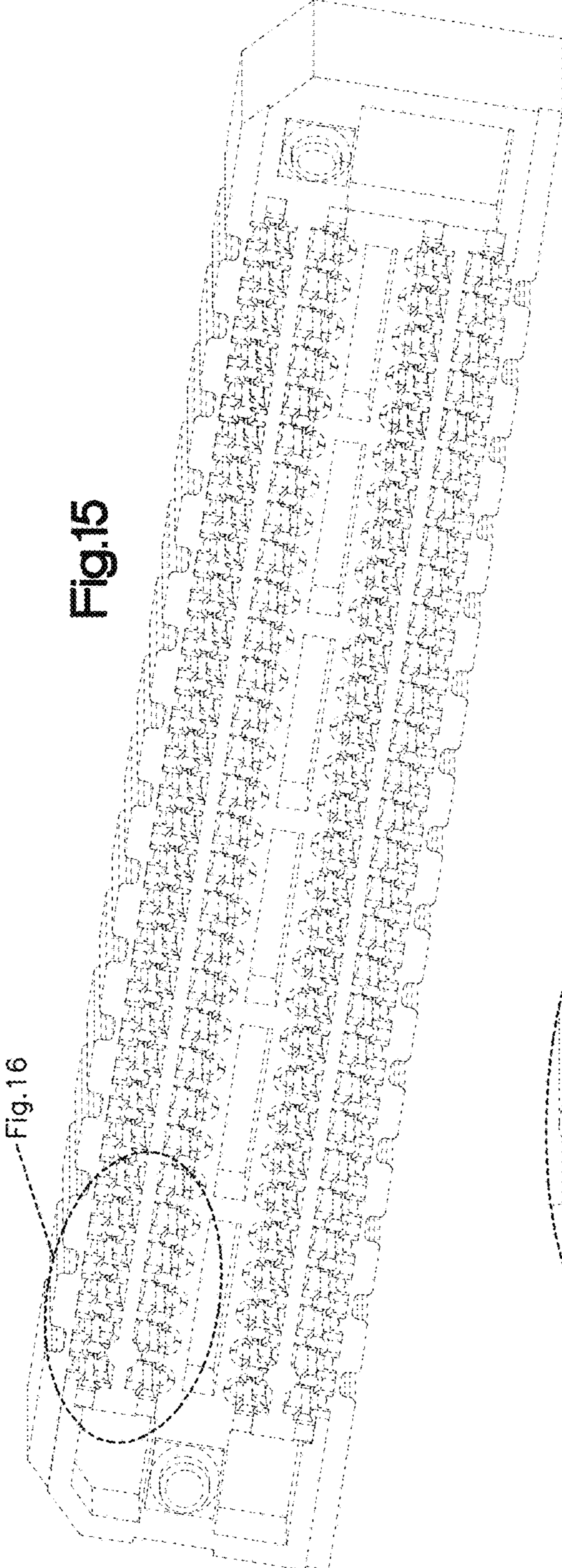

Fig. 15

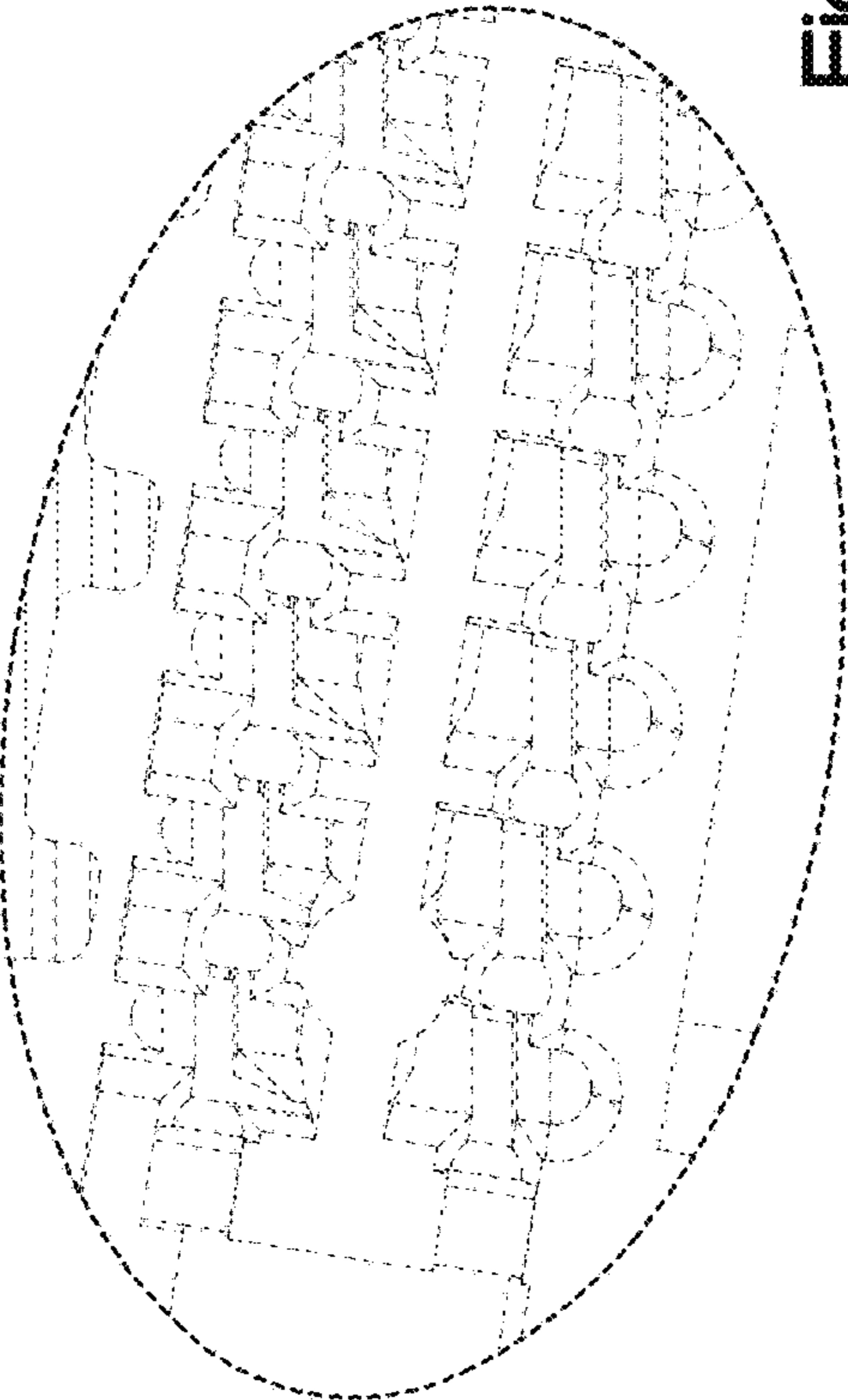

Fig. 16

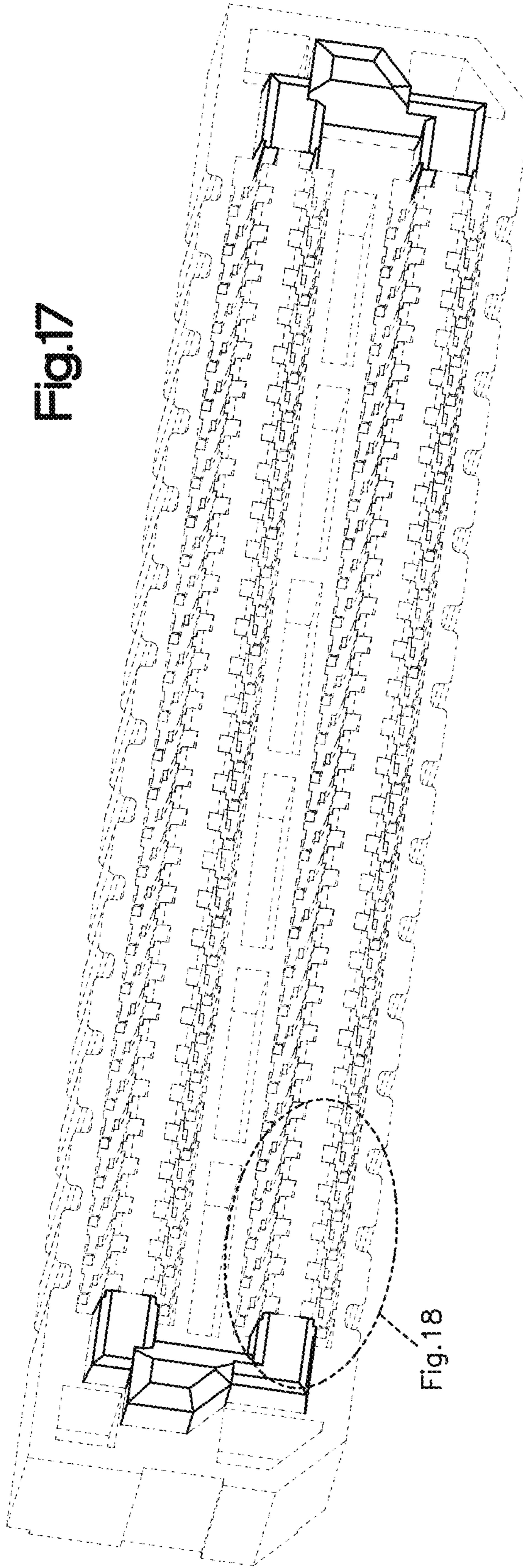

Fig.17

Fig.18

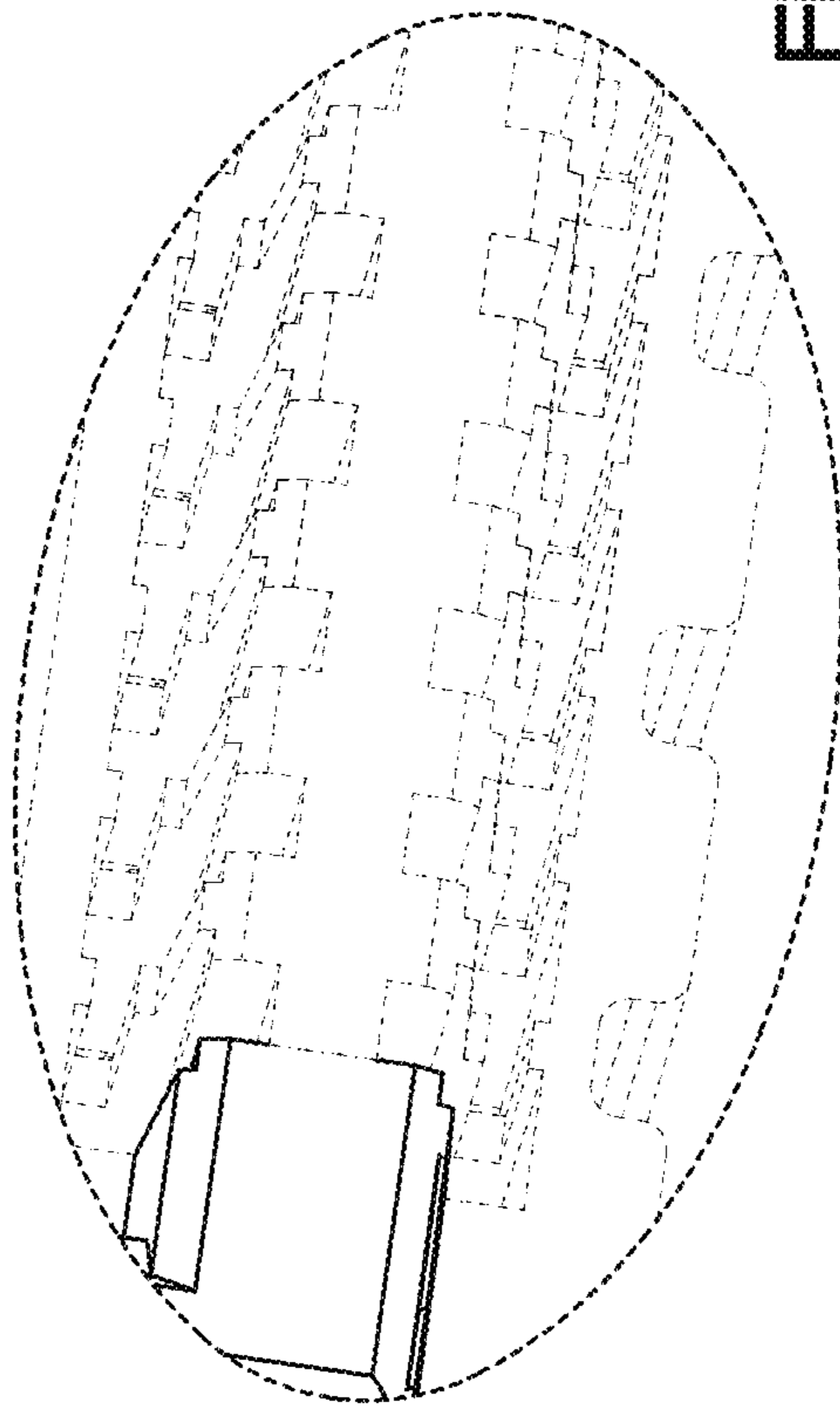

Fig.18

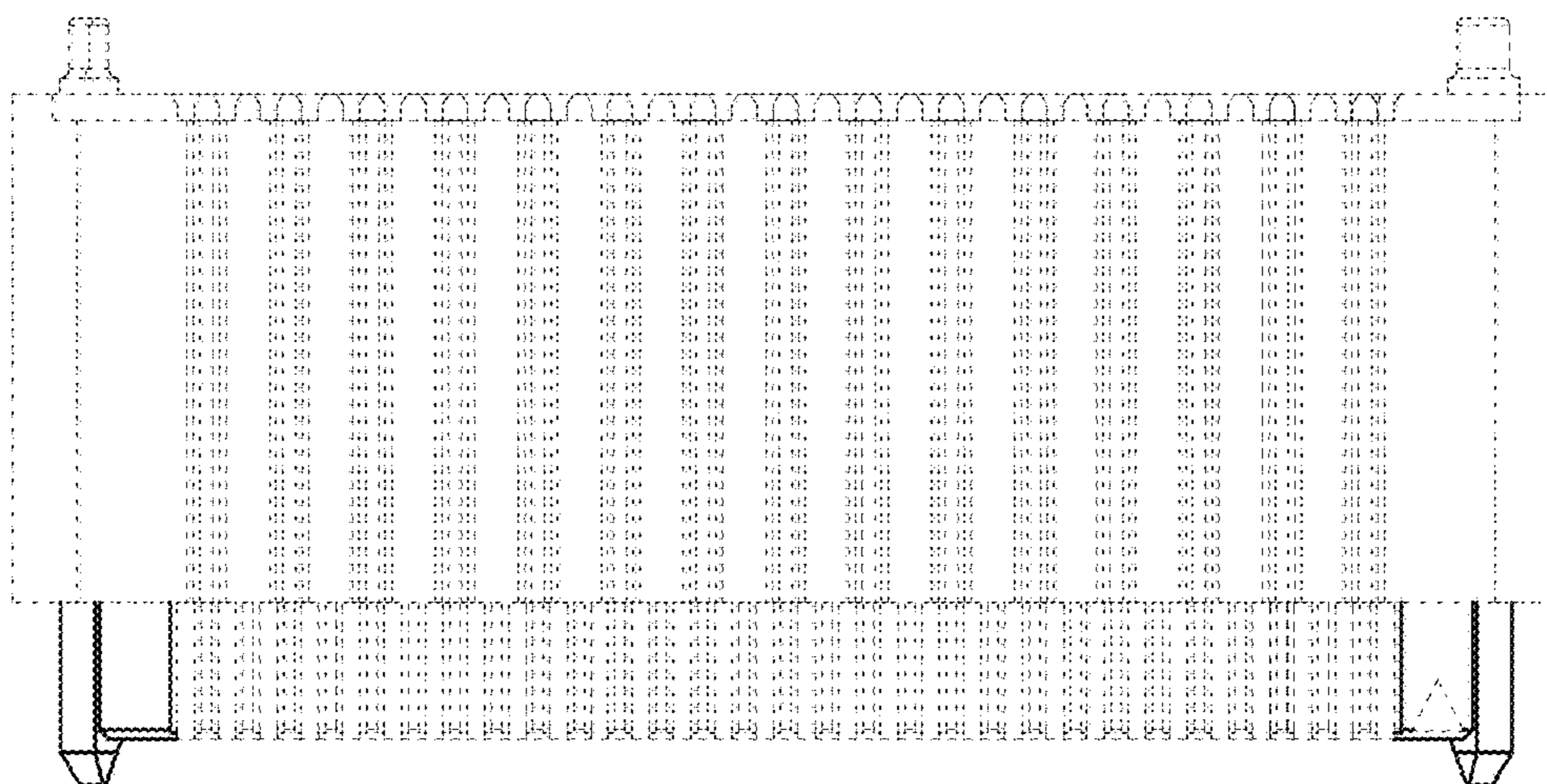

Fig.19

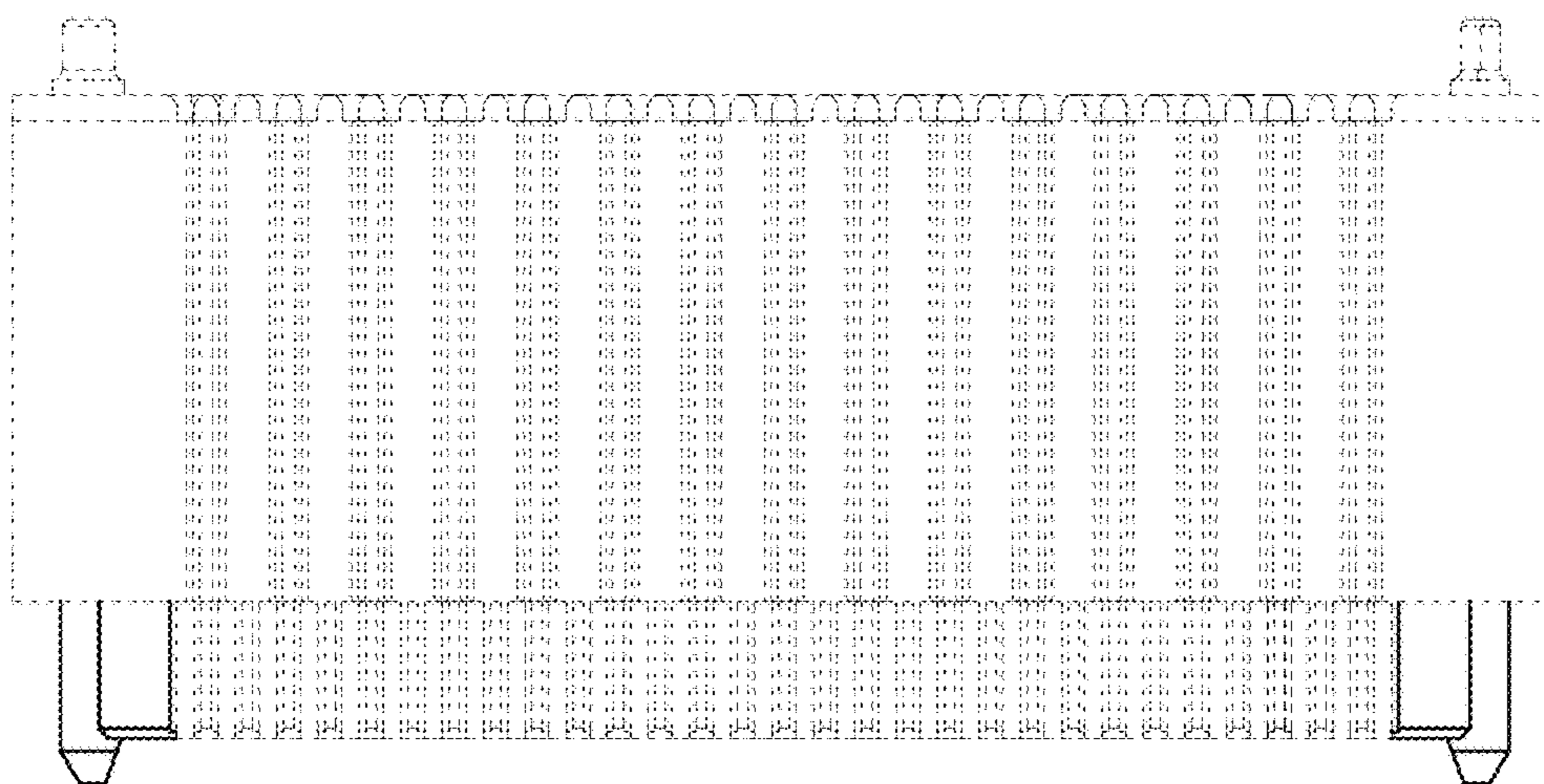

Fig.20

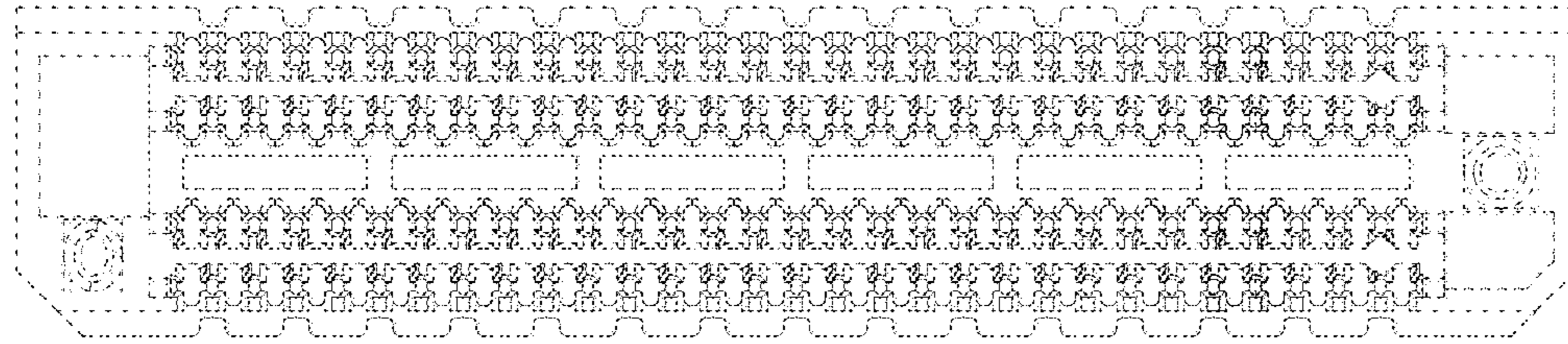

Fig.21

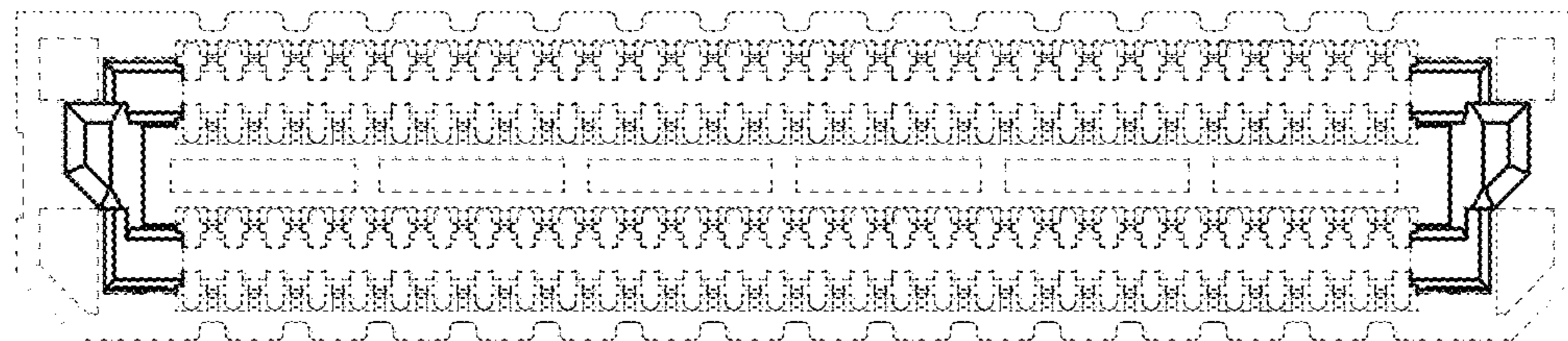

Fig.22

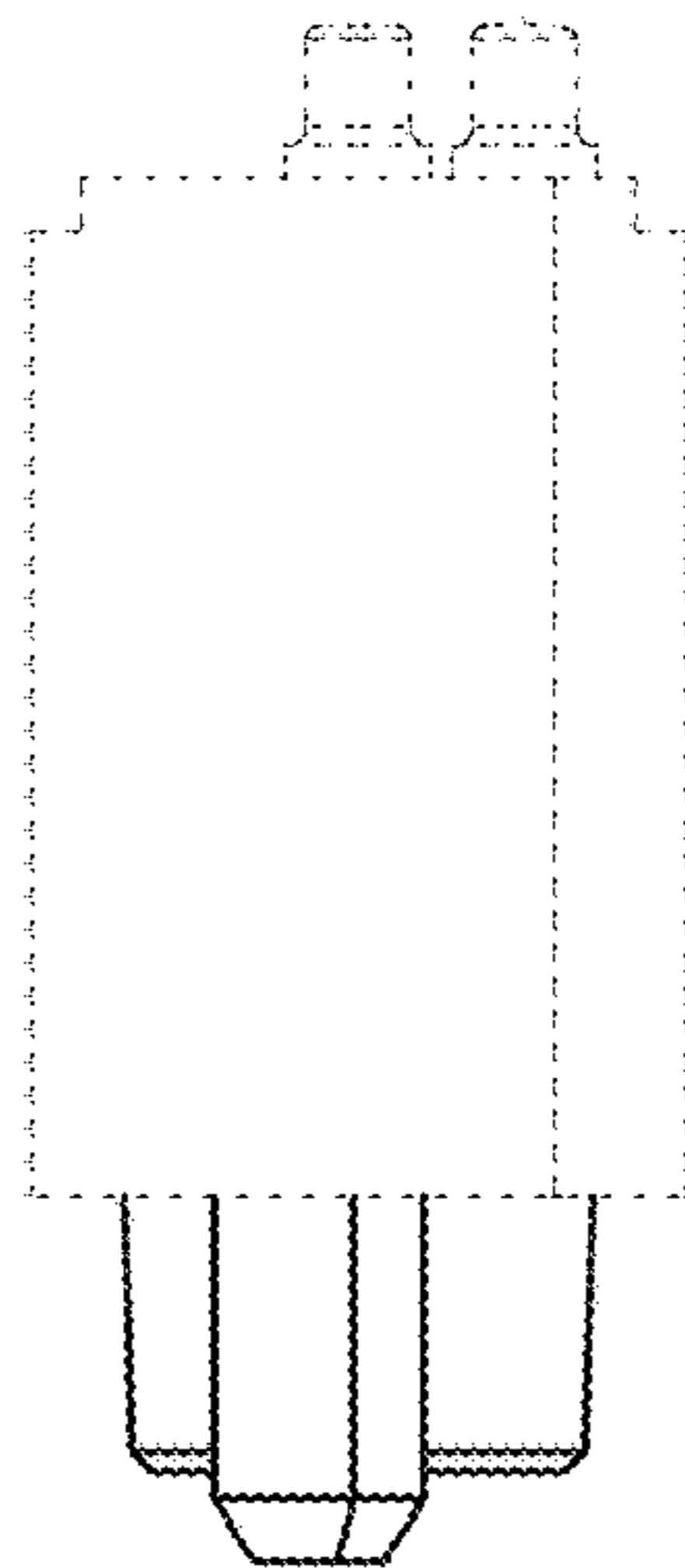

Fig.23

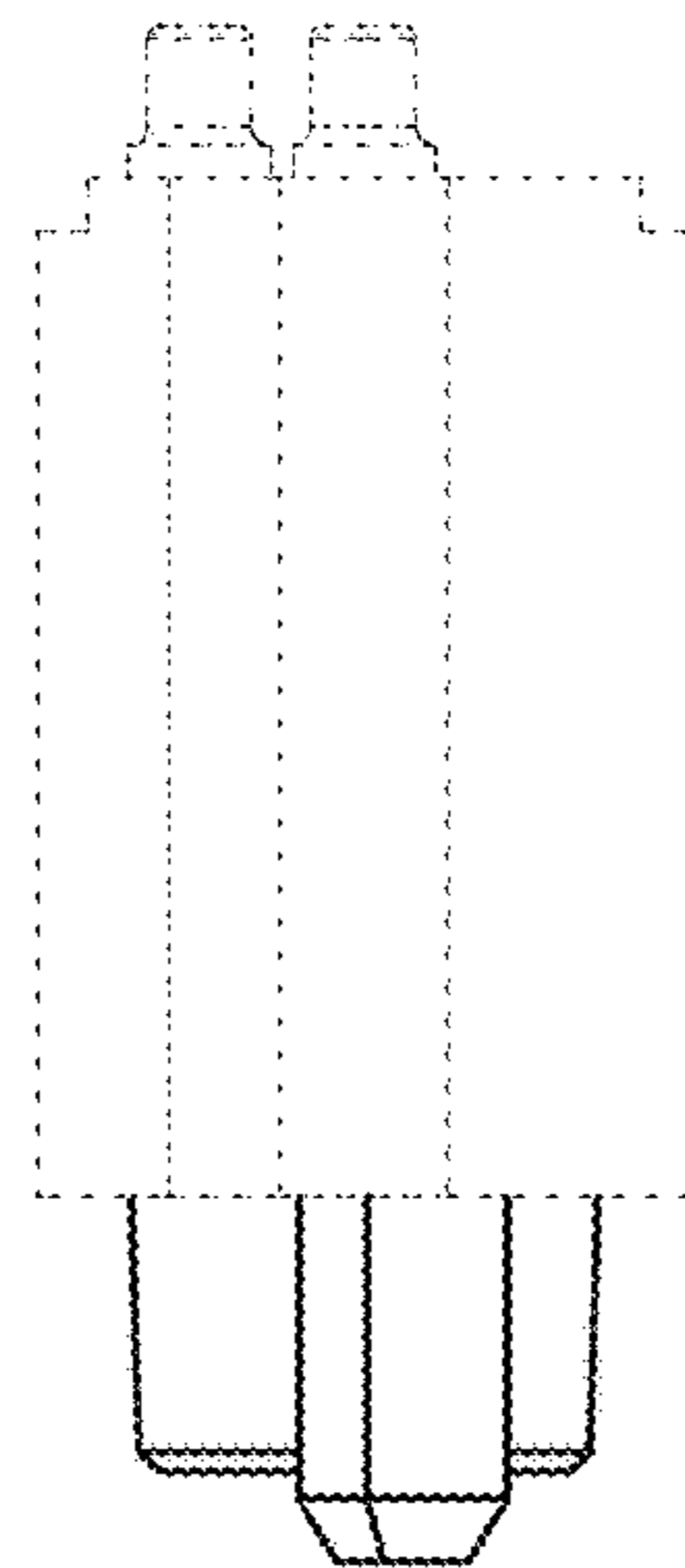
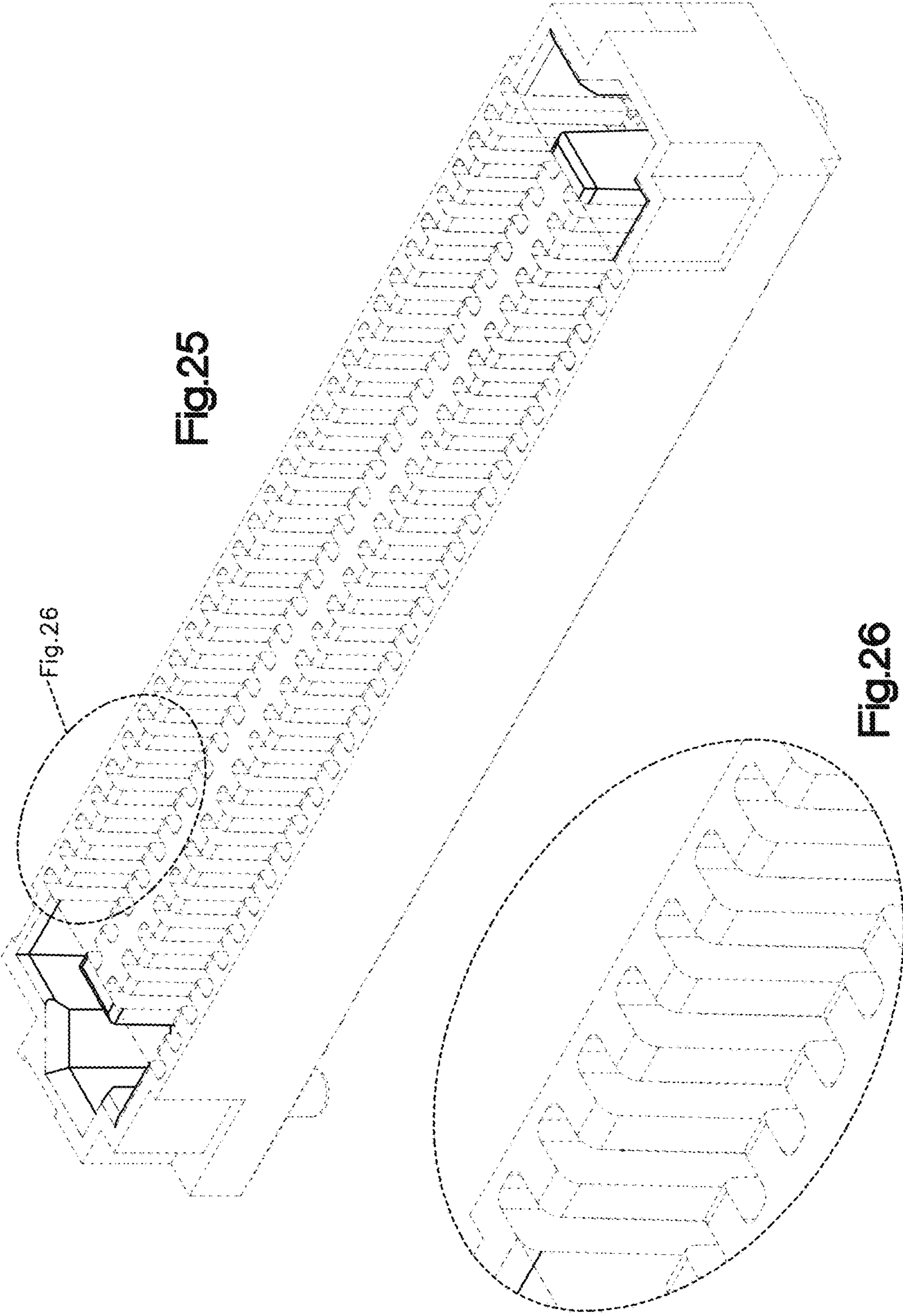

Fig.24



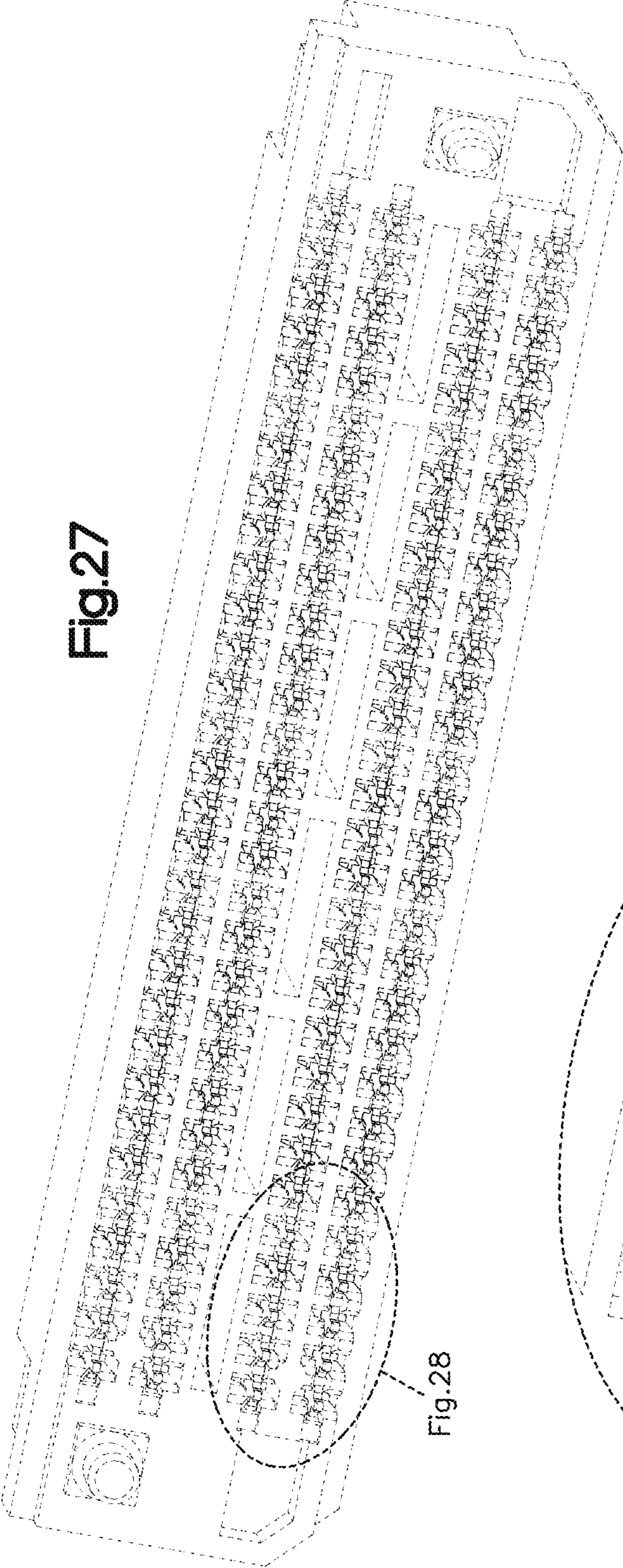

Fig.27

Fig.28

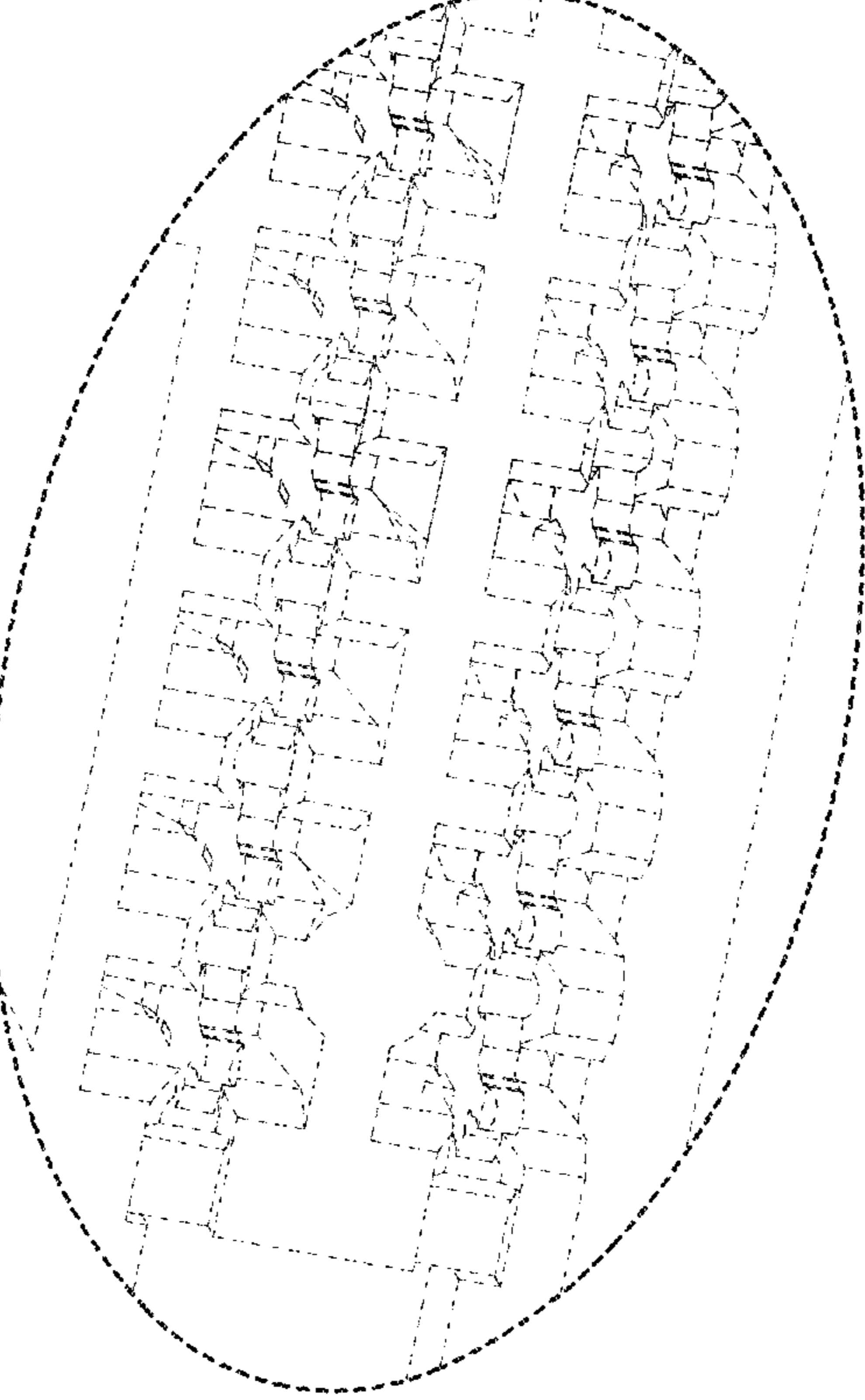
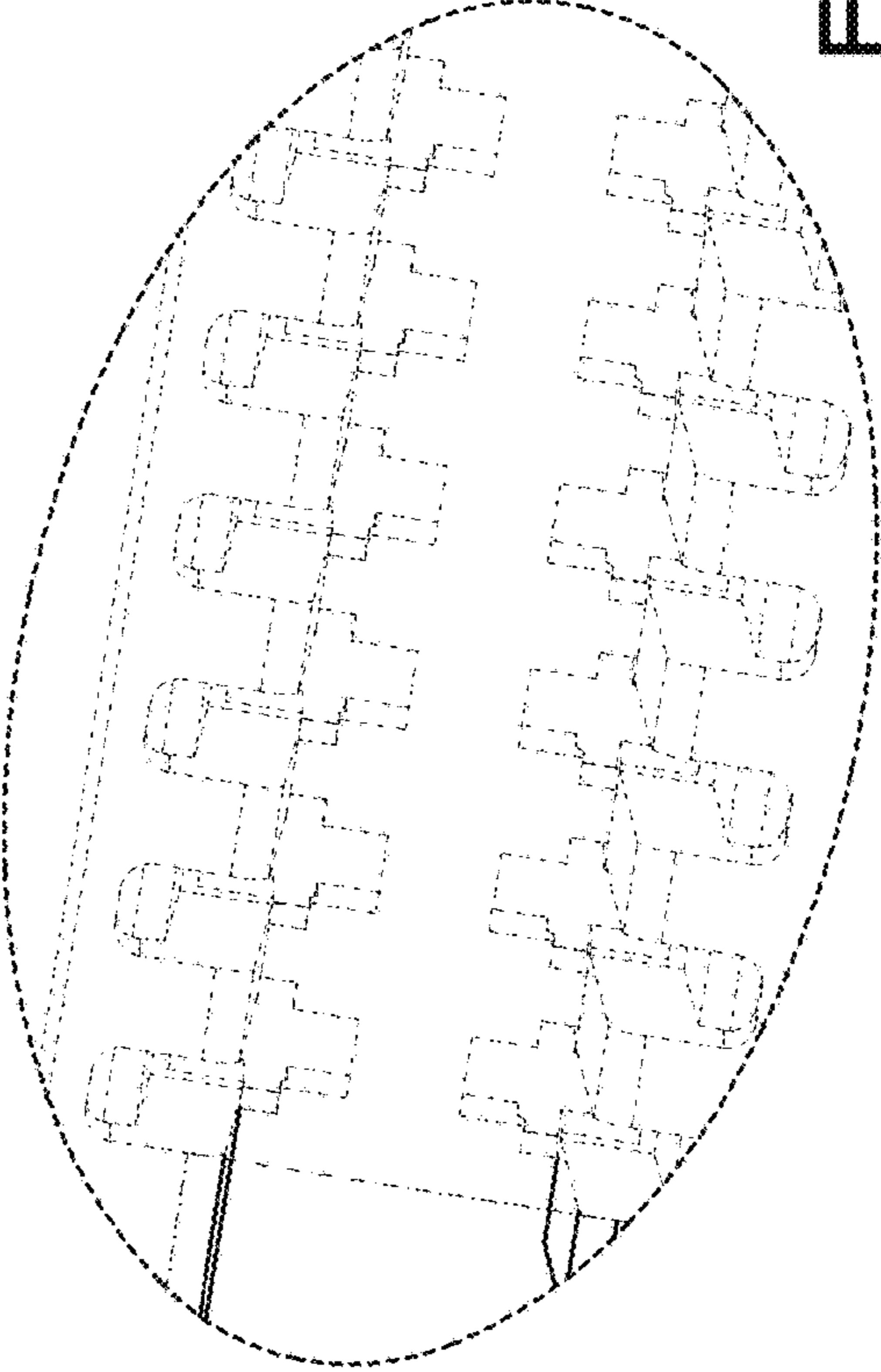
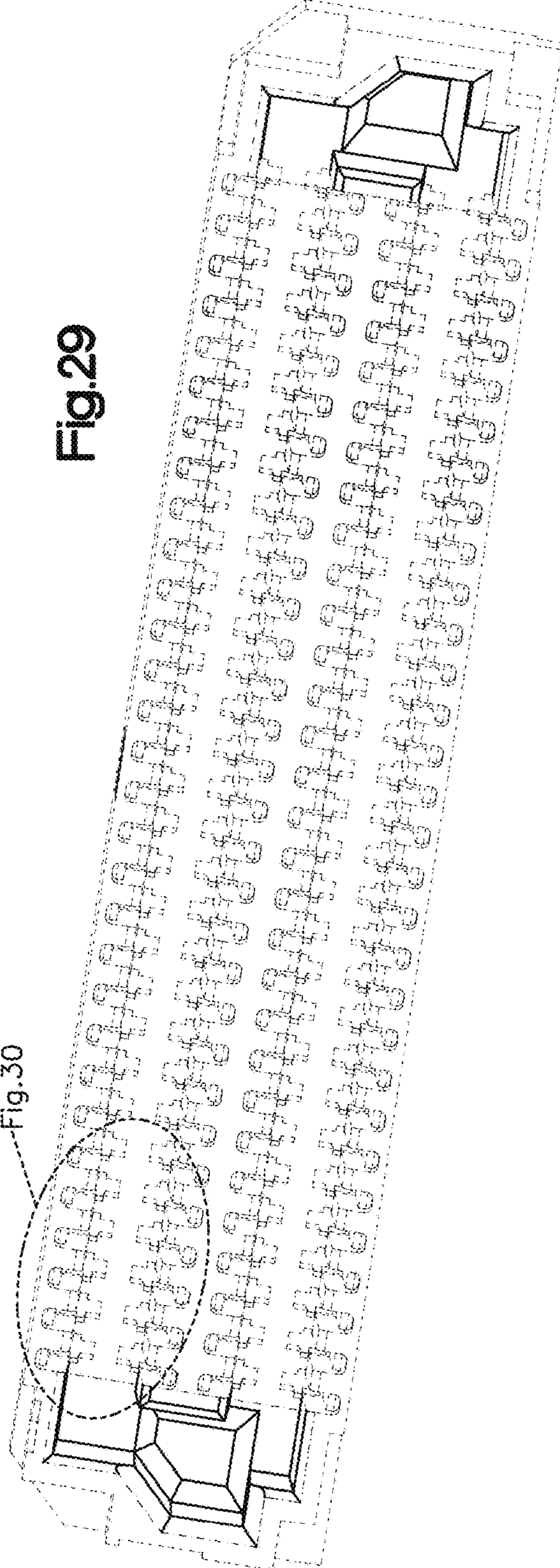

Fig.28



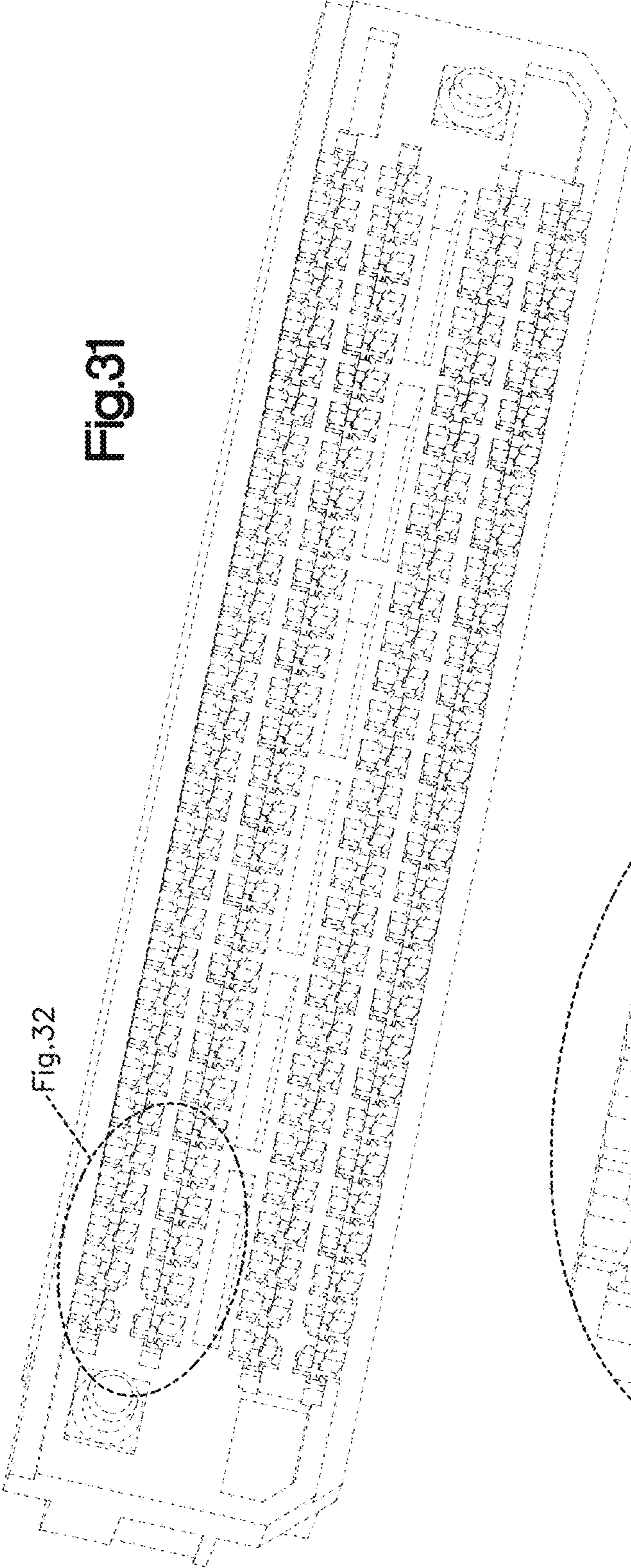

Fig.31

Fig.32

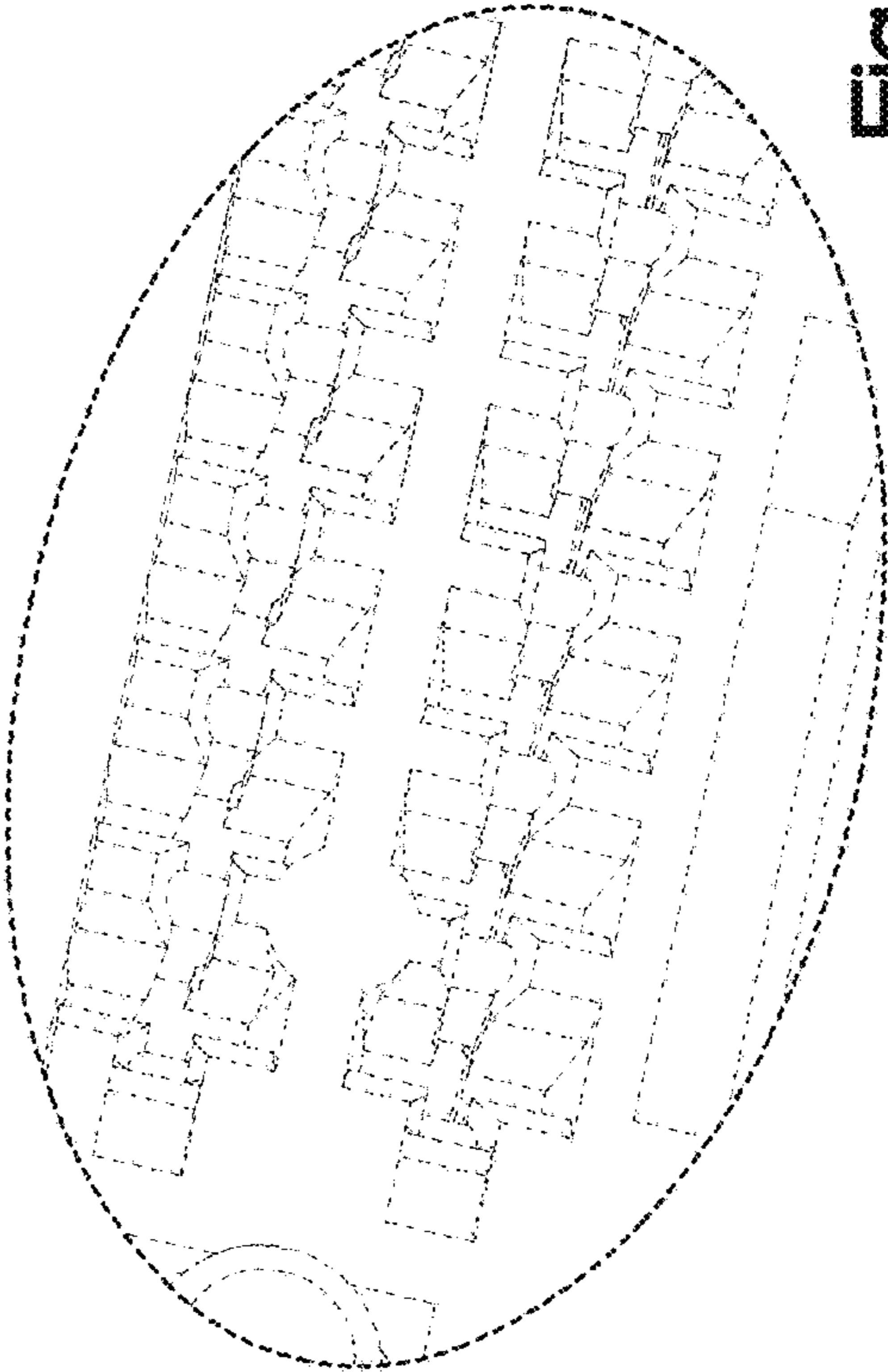

Fig.32

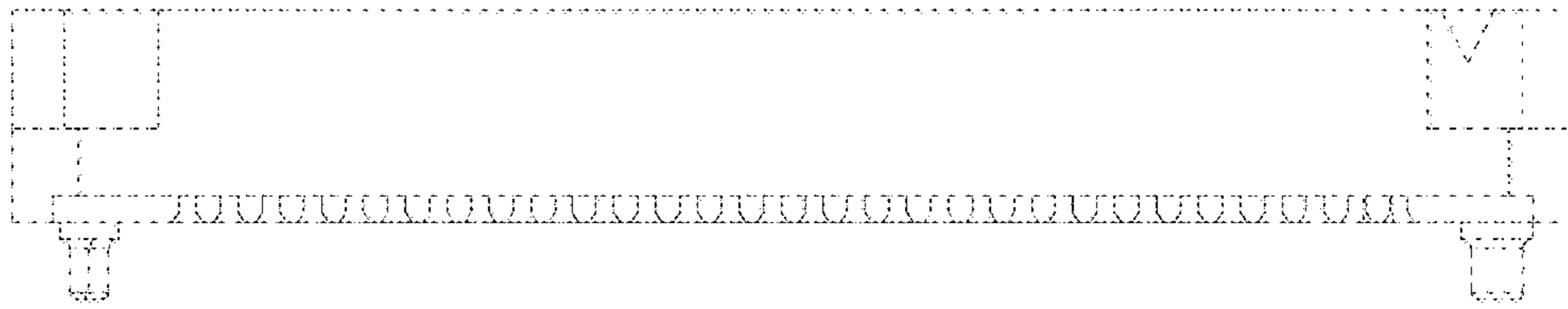

Fig.33

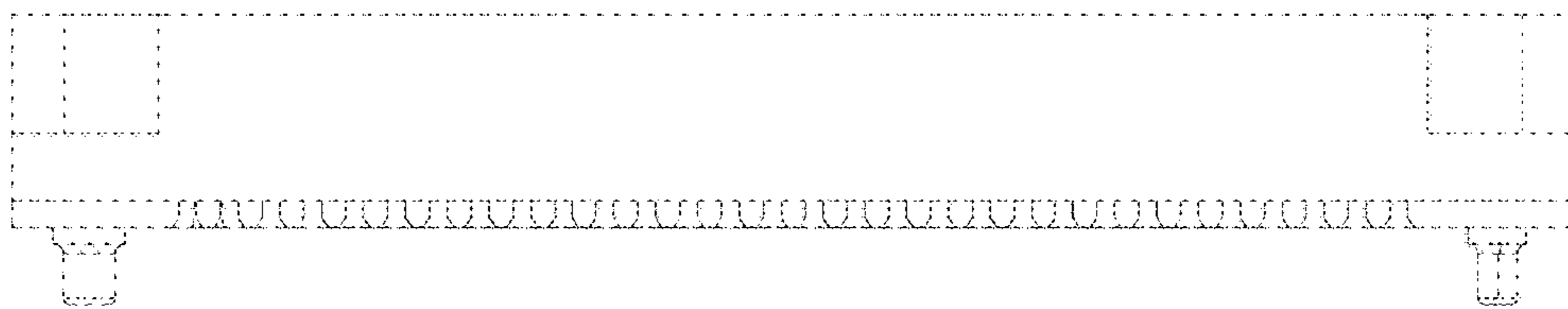

Fig.34

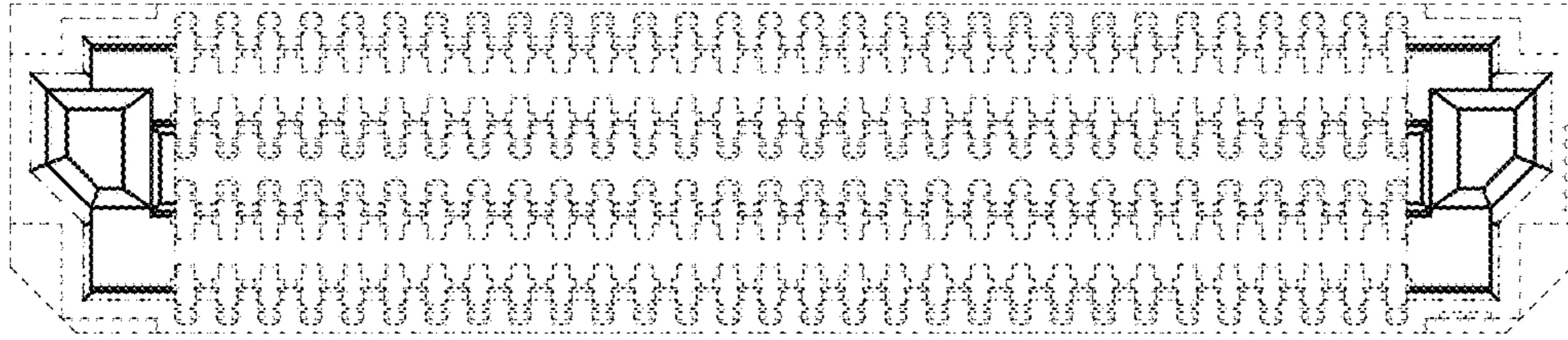

Fig.35

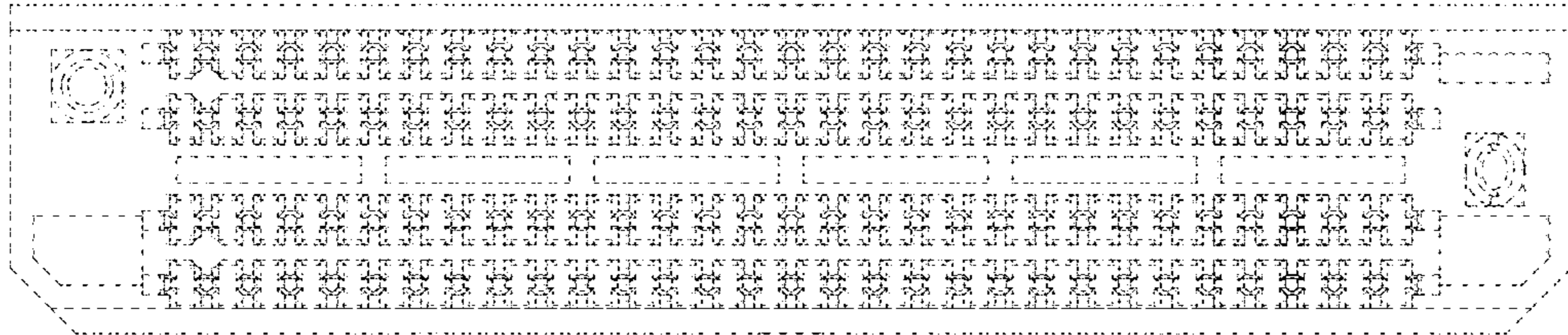

Fig.36

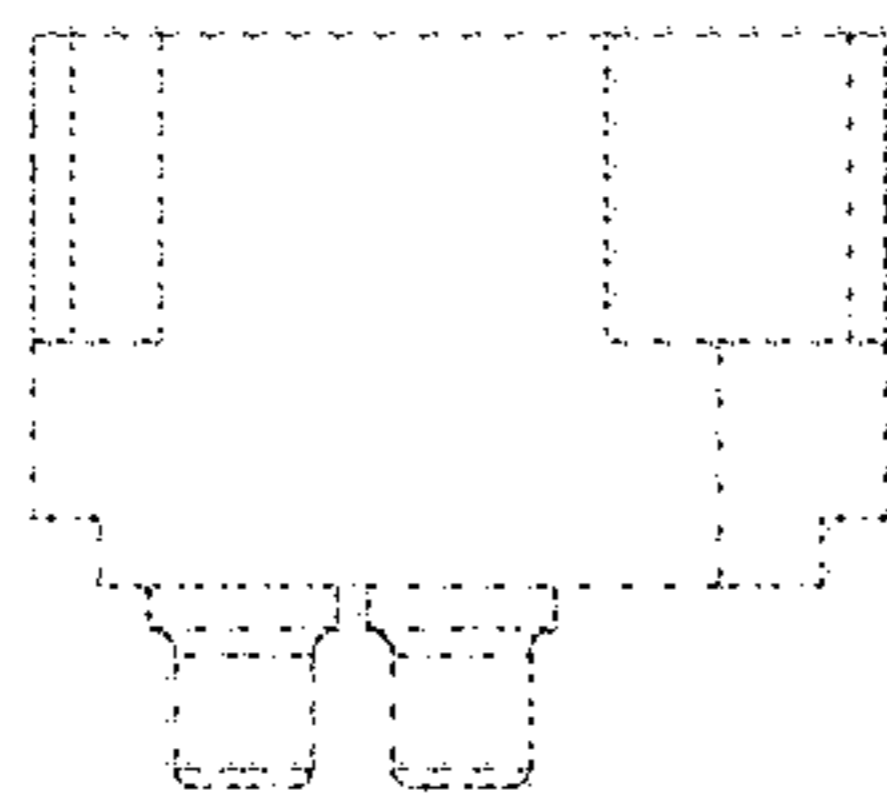

Fig.37

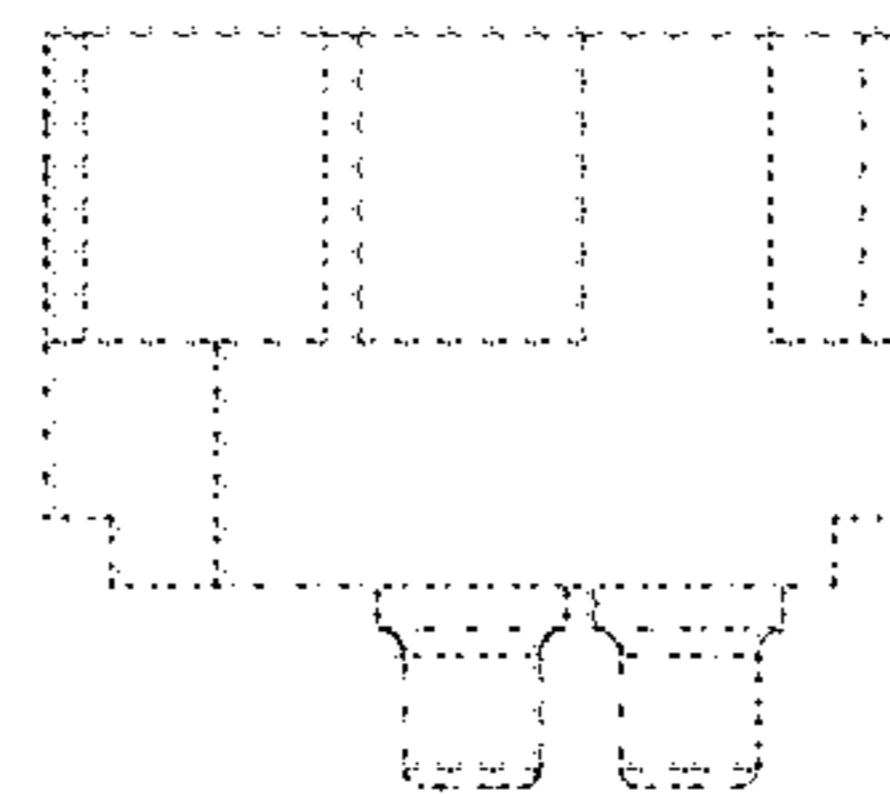

Fig.38