



US00D850967S

(12) **United States Design Patent**
Cassidy

(10) **Patent No.:** **US D850,967 S**
(45) **Date of Patent:** **** Jun. 11, 2019**

- (54) **WATCH DIAL HAVING A
THREE-DIMENSIONAL HUMAN FACE**
- (71) Applicant: **John Cassidy**, Pembroke Pines, FL
(US)
- (72) Inventor: **John Cassidy**, Pembroke Pines, FL
(US)
- (**) Term: **15 Years**
- (21) Appl. No.: **29/621,191**
- (22) Filed: **Oct. 5, 2017**
- (51) **LOC (11) Cl.** **10-07**
- (52) **U.S. Cl.**
USPC **D10/126**
- (58) **Field of Classification Search**
USPC D10/1, 2-3, 5-7, 14-15, 22-28, 40-41,
D10/46.1, 46.2, 49-50, 52, 55, 59,
D10/122-124, 126-128, 132;
D14/170-171, 197, 218, 489-490, 492;
D15/28; D20/20-21, 29; D7/589;
D11/160; D21/603; D19/20, 113
CPC G04B 19/00; G04B 19/04; G04B 19/042;
G04B 19/044; G04B 19/06; G04B
19/065; G04B 19/08; G04B 19/085;
G04B 19/26; G04B 19/264; G04B
45/0069; G04B 47/02; G04B 47/04;
G04B 47/048; G04C 3/001; G04C 19/00;
G04C 19/02; G04C 19/06; G04F 1/00;
G04F 3/00; G04F 3/02; A47J 31/407
See application file for complete search history.

(56) **References Cited**

U.S. PATENT DOCUMENTS

- D38,022 S * 5/1906 Lawson 106/156.5
- 2,124,767 A * 7/1938 Dawn A41G 7/00
D11/89
- D121,024 S * 6/1940 Tang D21/660
- D144,851 S * 5/1946 Frohman D11/55

- D245,545 S * 8/1977 Chou D21/660
 - 4,397,701 A * 8/1983 Johnson A41G 7/00
156/247
 - 4,485,921 A * 12/1984 Geller B65D 73/00
206/281
 - D278,737 S * 5/1985 Koper D21/660
 - D285,497 S * 9/1986 McElfresh D29/106
- (Continued)

OTHER PUBLICATIONS

Vacheron Constantin Les Masques Watches 2008 | posted at truetimetools.wordpress.com Sep. 2010 [online][site visited Jul. 6, 2018]. Available from internet: <<https://truetimetools.wordpress.com/2010/09/23/vacheron-constantin-metiers-d%E2%80%99art-les-masques-08/>> (Year: 2010).*

(Continued)

Primary Examiner — Sandra S Snapp
Assistant Examiner — Katherine Glennon
(74) *Attorney, Agent, or Firm* — Johnson & Martin, P.A.;
James David Johnson

(57) **CLAIM**

The ornamental design for a watch dial having a three-dimensional human face, as shown and described.

DESCRIPTION

FIG. 1 is a top plan view of a watch dial.
FIG. 2 is a right side view of the watch dial of FIG. 1.
FIG. 3 is a left side view of the watch dial of FIG. 1.
FIG. 4 is a top side view of the watch dial of FIG. 1.
FIG. 5 is a bottom side view of the watch dial of FIG. 1.
FIG. 6 is a perspective view of the watch dial of FIG. 1, shown installed in a watch; and,
FIG. 7 is an enlarged top plan view of the watch dial of FIG. 1, shown installed in a watch.
The broken line illustrations of the watch casing, watch bands, and watch hands illustrate portions of the article that form no part of the claimed design.

1 Claim, 4 Drawing Sheets

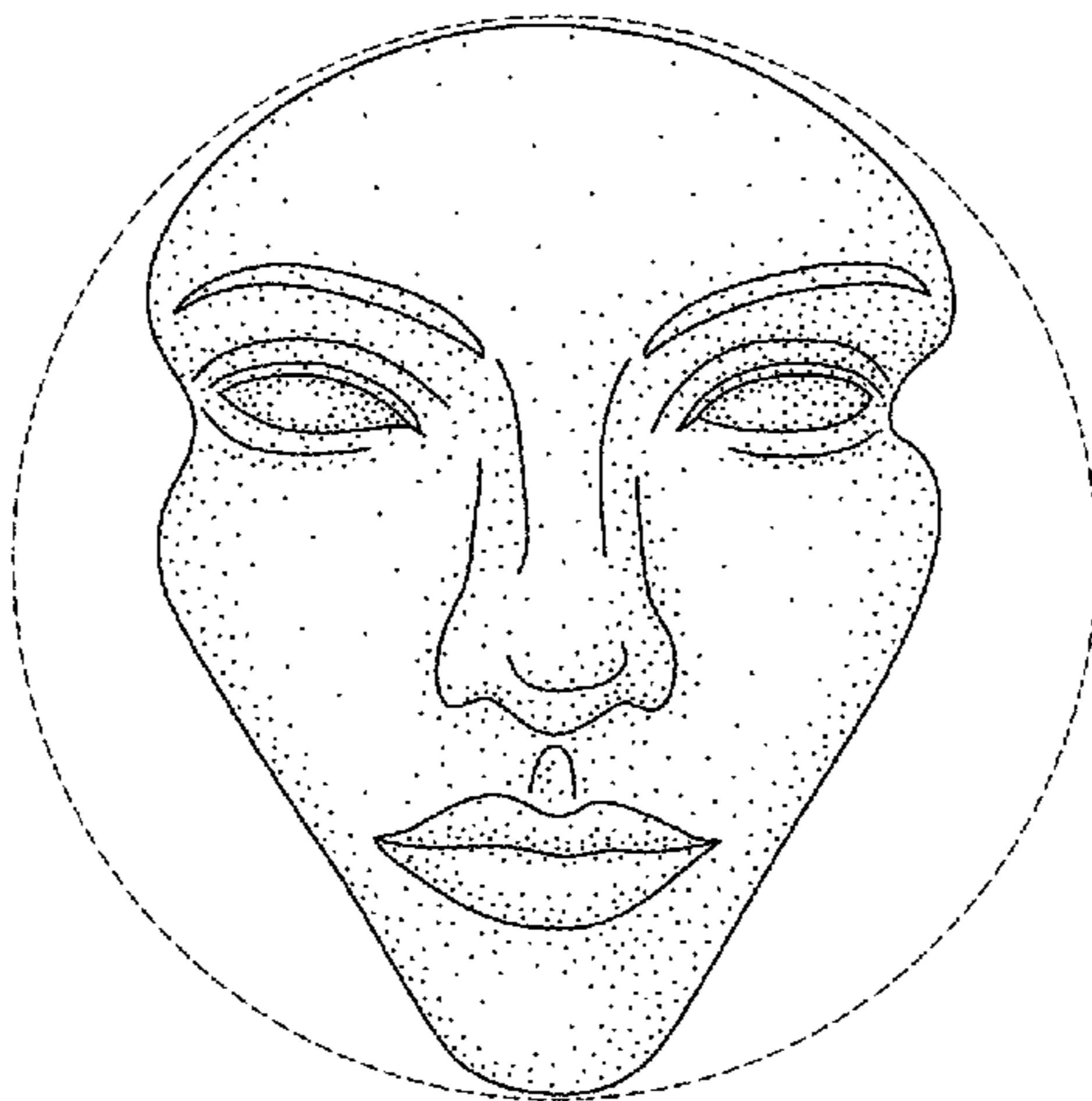

(56)

References Cited

U.S. PATENT DOCUMENTS

4,941,212 A * 7/1990 Liff A41G 7/00
2/206
D358,685 S * 5/1995 Rounder D29/108
6,251,525 B1 * 6/2001 Yau B44C 3/06
156/59
D480,861 S * 10/2003 Quinn D2/866
D485,874 S * 1/2004 Reitz D21/660
D494,644 S * 8/2004 Quinn D2/866
8,874,251 B2 * 10/2014 Thornton A61M 16/06
128/205.25
D787,115 S * 5/2017 Pan D28/7

OTHER PUBLICATIONS

Art Deco Goldscheider Female Wall Masks | posted at pinterest.
co.uk n.d. vintage 1930s [onlin][site visited Jul. 6, 2018]. Available
from internet: <<https://www.pinterest.co.uk/pin/369647081889468916/>>
(Year: 1930).*

* cited by examiner

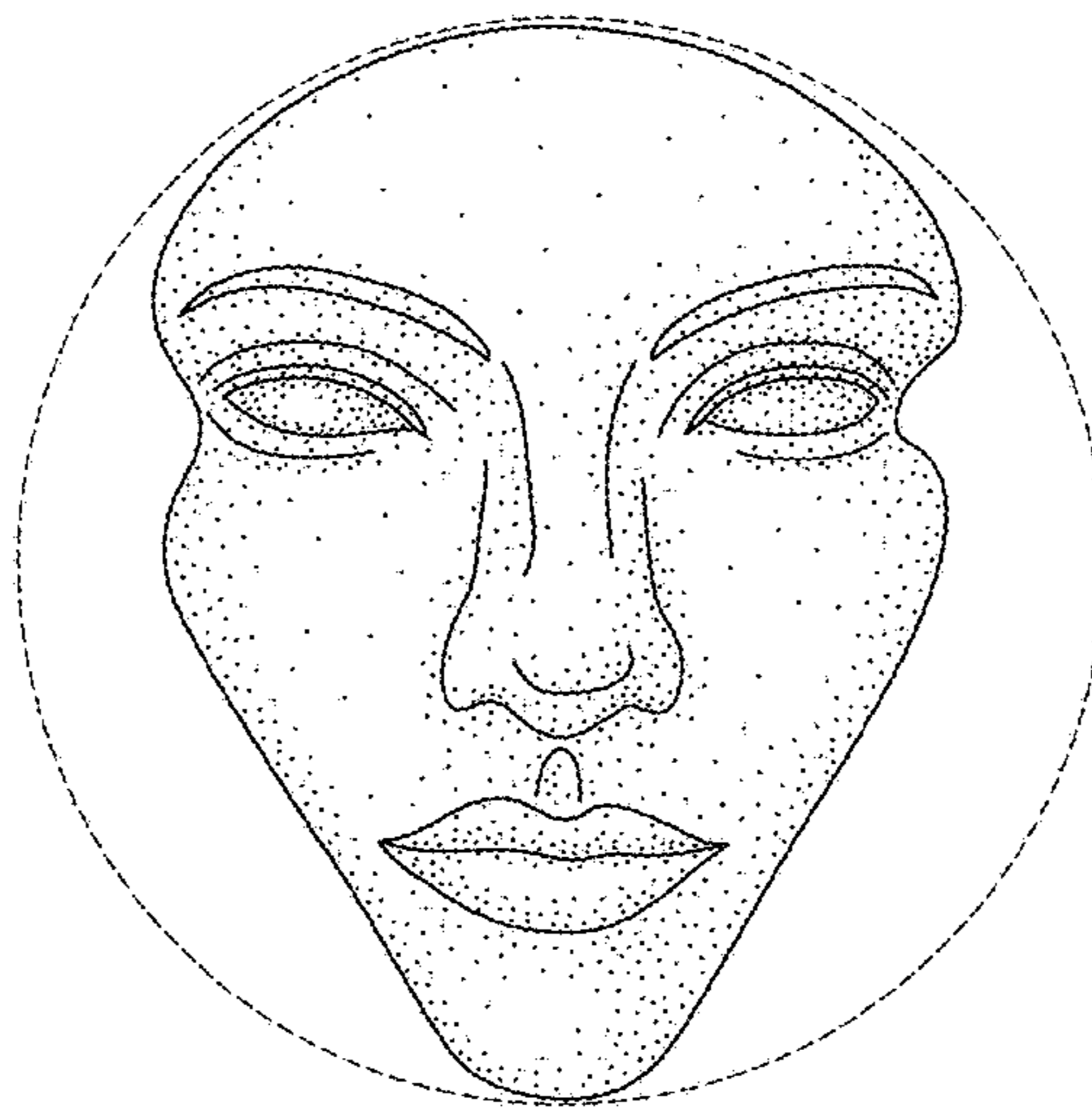

FIG. 1

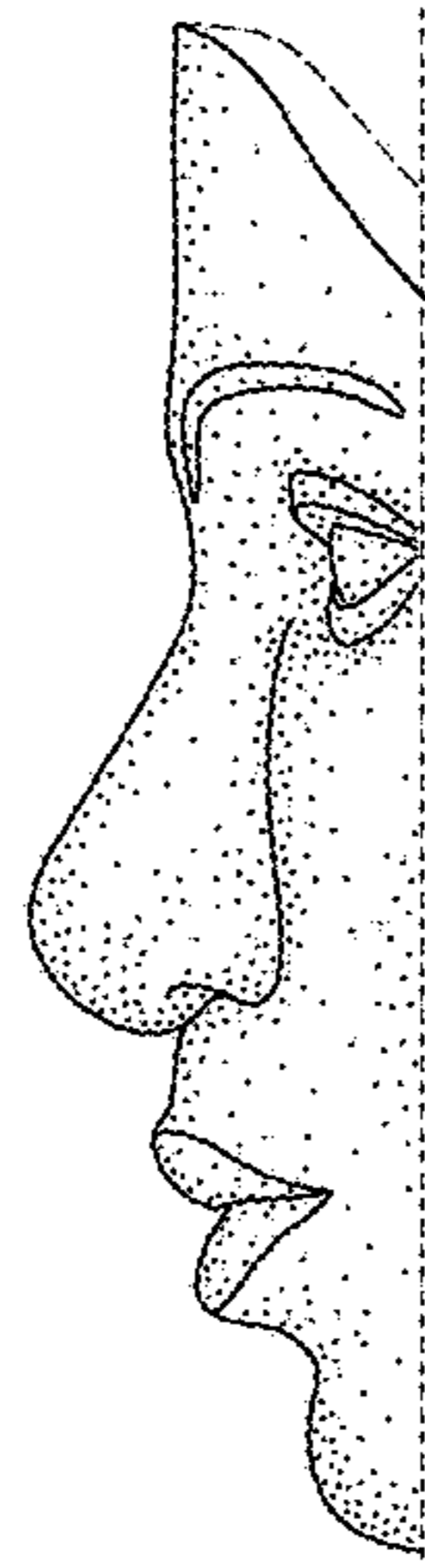

FIG. 2

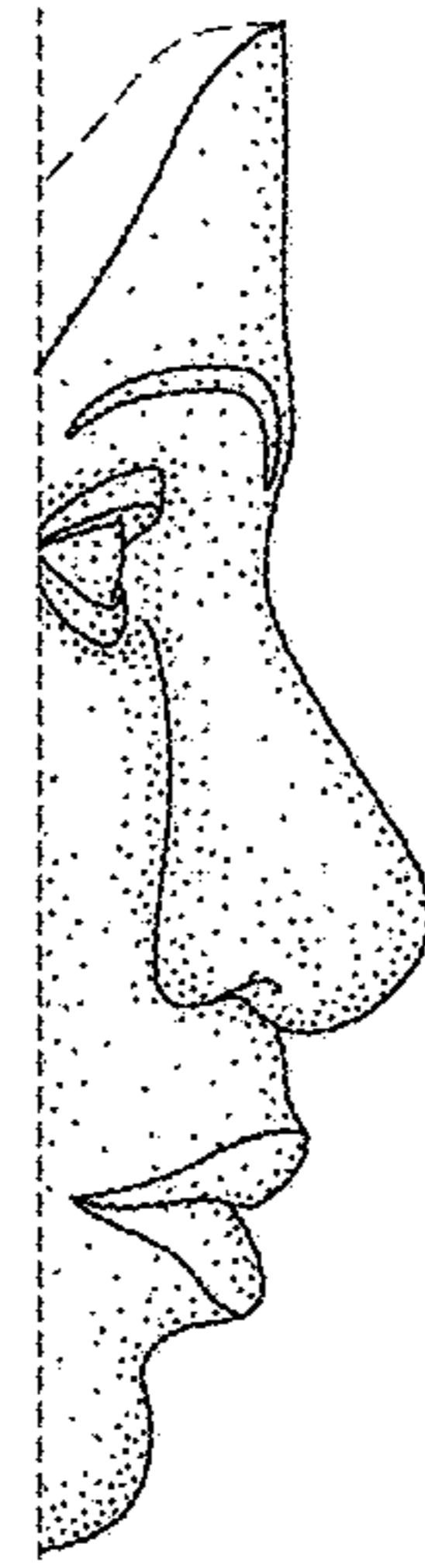

FIG. 3

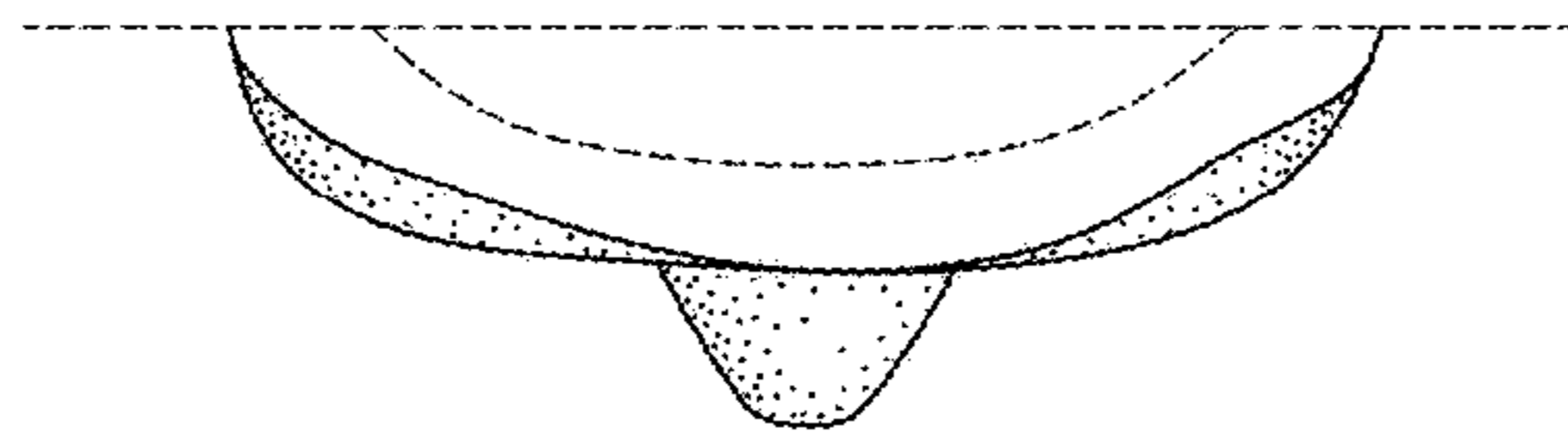

FIG. 4

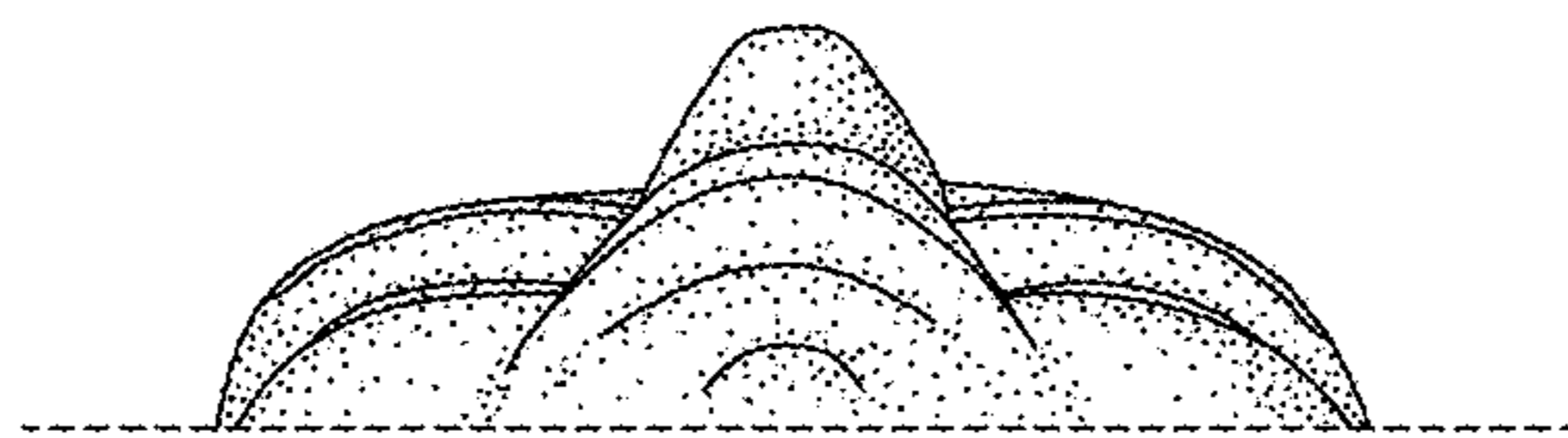

FIG. 5

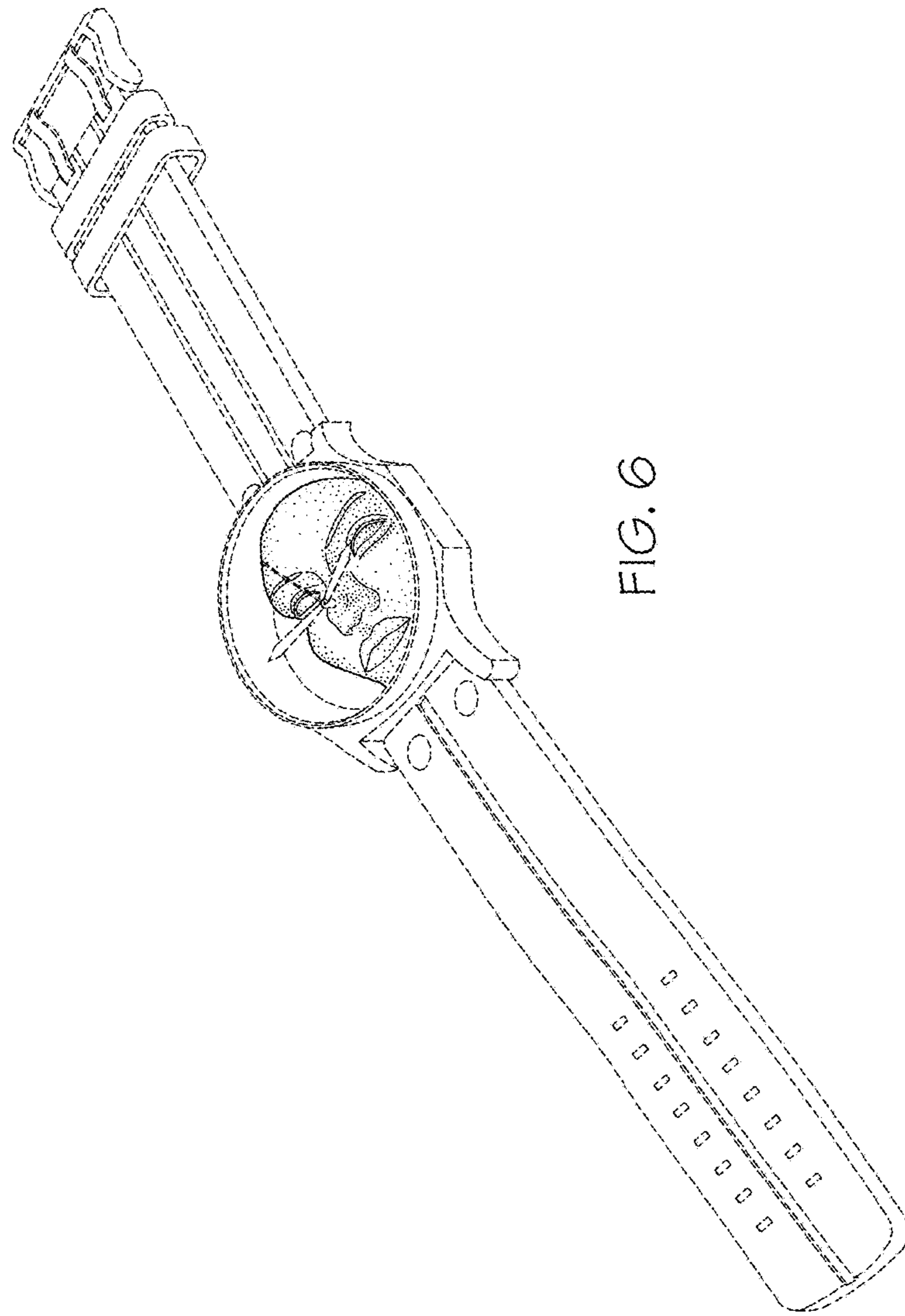

FIG. 6

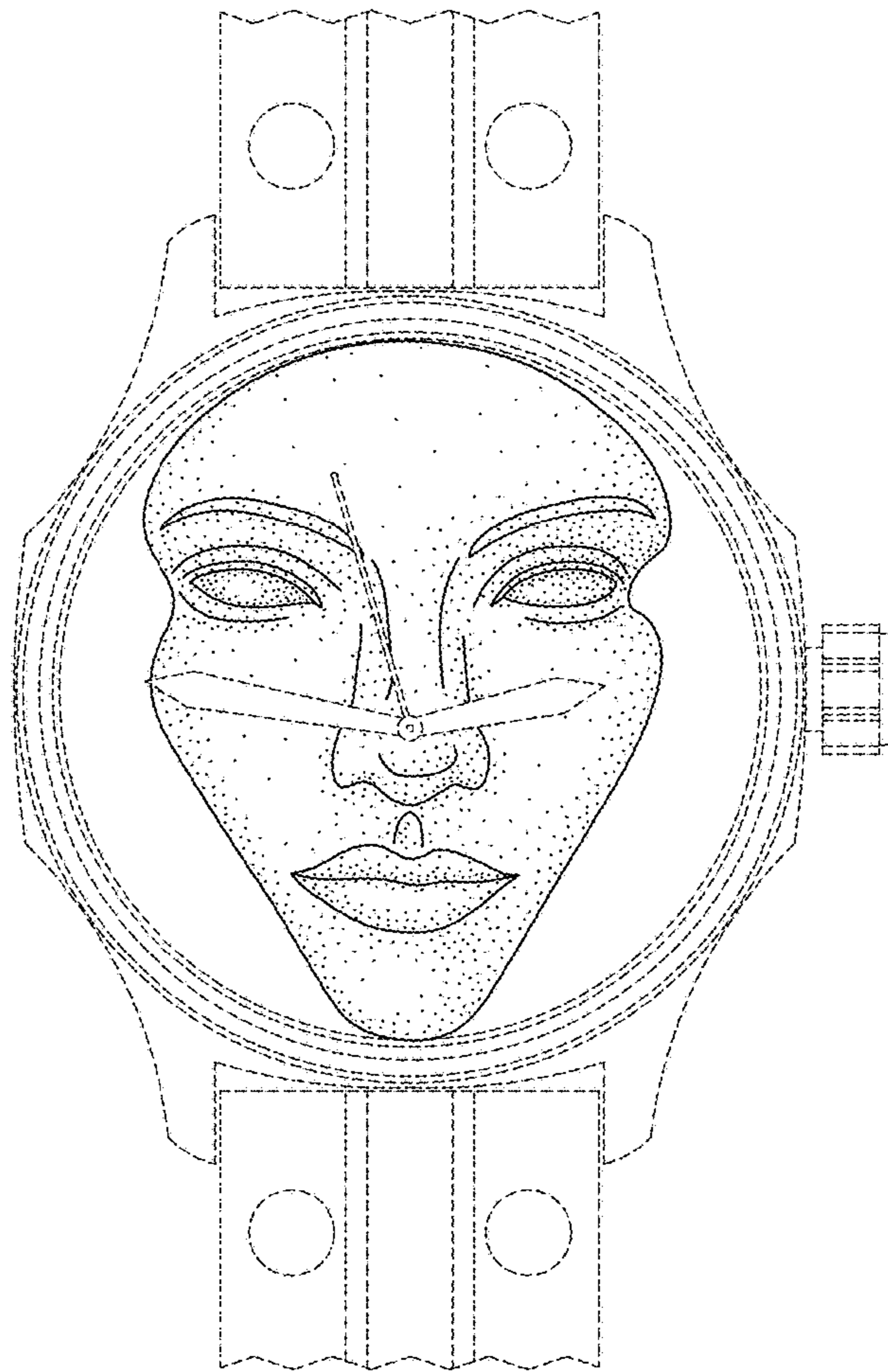

FIG. 7