



US00D850912S

(12) **United States Design Patent**  
**Wilson et al.**

(10) **Patent No.:** **US D850,912 S**  
(45) **Date of Patent:** **\*\* Jun. 11, 2019**

(54) **THREE DOOR CONTAINER LID**

1,295,997 A 3/1919 Mennen  
(Continued)

(71) Applicant: **MCCORMICK & COMPANY, INCORPORATED**, Hunt Valley, MD (US)

*Primary Examiner* — Michael A. Pratt  
*Assistant Examiner* — Wendy L Arminio  
(74) *Attorney, Agent, or Firm* — Greenblum & Bernstein, P.L.C.

(72) Inventors: **Tracie L. C. Wilson**, Westminster, MD (US); **Darin Pugne**, Carnegie, PA (US); **Adam Beaty**, Lebanon, TN (US)

(57) **CLAIM**

We claim the ornamental design for a three door container lid, as shown and described.

(73) Assignee: **MCCORMICK & COMPANY, INCORPORATED**, Hunt Valley, MD (US)

**DESCRIPTION**

(\*\*) Term: **15 Years**

(21) Appl. No.: **29/578,136**

(22) Filed: **Sep. 19, 2016**

(51) **LOC (11) Cl.** ..... **09-07**

(52) **U.S. Cl.**  
USPC ..... **D9/449**

(58) **Field of Classification Search**  
USPC ..... D9/414, 417, 432, 434, 435, 438, D9/443-450, 499, 682-685; D7/387, D7/392, 392.1, 396.1, 401.1, 538; D3/294, 318  
CPC .. A61J 1/00; A61J 1/1412; B65D 1/00; B65D 1/02; B65D 1/10; B65D 1/46; B65D 2585/56; B65D 2585/545; B65D 41/00; B65D 41/38; B65D 41/56; B65D 41/62; B65D 47/00; B65D 47/06; B65D 47/08;  
(Continued)

FIG. 1 shows a front, top, right side perspective view of a three door container lid with all doors in the closed position; FIG. 2 shows a front view of FIG. 1; FIG. 3 shows a back view of FIG. 1; FIG. 4 shows a left side view of FIG. 1; FIG. 5 shows a right side view of FIG. 1; FIG. 6 shows a top view of FIG. 1; FIG. 7 shows a bottom view of FIG. 1; FIG. 8 shows a front side view of the three door container lid of FIG. 1 with a lid main door shown open 90 degrees; FIG. 9 shows a back side view of FIG. 8; FIG. 10 shows a left side view of FIG. 8; FIG. 11 shows a right side view of FIG. 8; FIG. 12 shows a top view of FIG. 8; FIG. 13 shows a bottom view of FIG. 8; FIG. 14 shows a front side view of the three door container lid of FIG. 1 with two side lid doors shown open 90 degrees; FIG. 15 shows a back side view of FIG. 14; FIG. 16 shows a right side view of FIG. 14; FIG. 17 shows a left side view of FIG. 14; FIG. 18 shows a top view of FIG. 14; FIG. 19 shows a bottom view of FIG. 14; and, FIG. 20 shows a front side view of the three-door container lid of FIG. 1 installed on an exemplary container. The broken lines in FIG. 20 illustrating a container depict environment and form no part of the claimed design. All other broken lines depict portions of the three door container lid that form no part of the claimed design.

(56) **References Cited**

**U.S. PATENT DOCUMENTS**

844,640 A 2/1907 West  
961,991 A 6/1910 Ullrich  
1,134,427 A 4/1915 Ullrich  
1,141,535 A 6/1915 Freundt  
1,184,549 A 5/1916 McClung

**1 Claim, 20 Drawing Sheets**

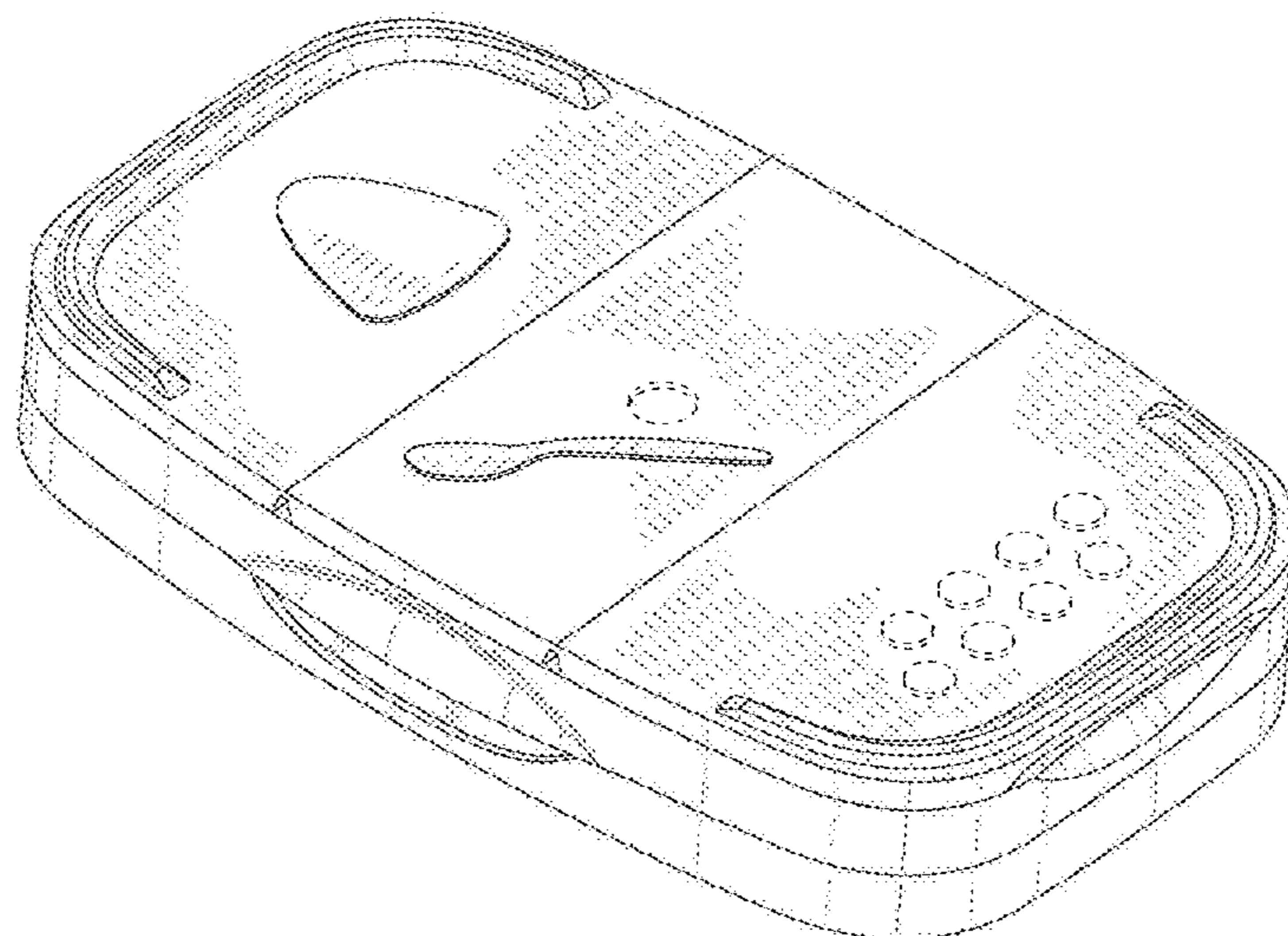

(58) **Field of Classification Search**  
 CPC ..... B65D 2543/00046; B65D 2543/00092;  
 B65D 2543/00296; B65D 5/46; B65D  
 2251/00  
 See application file for complete search history.

(56) **References Cited**  
 U.S. PATENT DOCUMENTS

1,658,348 A 2/1928 Michael  
 1,767,781 A 6/1930 Aulbach et al.  
 1,803,799 A 5/1931 Gueritey  
 1,894,575 A 1/1933 Sherman  
 1,959,874 A 5/1934 Mills  
 2,045,855 A 6/1936 Hovey  
 2,046,929 A 7/1936 Schmidt  
 2,108,045 A 2/1938 Dirker  
 2,162,999 A 6/1939 Frank  
 2,167,574 A 7/1939 Jones  
 2,190,676 A 2/1940 Perry  
 2,235,987 A 3/1941 Frank  
 2,241,435 A 5/1941 White  
 2,273,998 A 2/1942 Rueger  
 2,273,999 A 2/1942 Rueger  
 2,283,245 A 5/1942 White  
 2,287,747 A 6/1942 Pardee  
 2,310,271 A 2/1943 Ziehmer  
 2,324,499 A 7/1943 Erb  
 2,346,847 A 4/1944 Larson  
 2,878,971 A 3/1959 Malachick  
 3,127,052 A 3/1964 Mayers  
 3,129,860 A 4/1964 Foster  
 3,155,285 A \* 11/1964 Van Baarn ..... B65D 47/0838  
 222/153.06  
 3,169,671 A 2/1965 Edward  
 3,187,964 A 6/1965 Foster  
 D204,509 S \* 4/1966 Waterman ..... D9/450  
 3,251,509 A 5/1966 Foster  
 3,255,928 A 6/1966 Foster  
 3,370,757 A 2/1968 Foster  
 3,397,823 A \* 8/1968 Kirkpatrick ..... B65D 47/0833  
 220/326  
 3,542,235 A \* 11/1970 Hidding ..... B65D 47/0842  
 220/254.2  
 3,589,572 A 6/1971 Hannon  
 3,737,066 A 6/1973 Ames  
 3,817,420 A 6/1974 Heisler  
 3,872,996 A 3/1975 Dogliotti  
 4,144,985 A 3/1979 Kinslow  
 4,253,587 A 3/1981 Otterson  
 4,280,636 A \* 7/1981 Lewis ..... B65D 47/0842  
 220/835  
 4,359,171 A \* 11/1982 Lewis ..... B65D 47/0842  
 220/835  
 4,369,901 A 1/1983 Hidding  
 4,463,869 A \* 8/1984 Lewis ..... B65D 47/0838  
 220/269  
 4,471,881 A 9/1984 Foster  
 4,494,679 A 1/1985 Cleevely  
 D278,675 S 5/1985 Tardif  
 4,526,291 A 7/1985 Margulies  
 4,592,480 A 6/1986 Hart  
 4,610,371 A \* 9/1986 Karkiewicz ..... B65D 47/0838  
 206/807  
 4,621,744 A 11/1986 Foster  
 4,634,019 A 1/1987 Pherigo  
 4,658,980 A 4/1987 Lindstrom  
 4,723,693 A 2/1988 Decoster  
 4,724,977 A 2/1988 Cleevely  
 4,724,979 A 2/1988 Cleevely  
 D301,549 S \* 6/1989 Foster ..... D9/435  
 4,934,554 A 6/1990 Edwards  
 4,934,557 A 6/1990 Smith  
 5,002,197 A 3/1991 Ponsi  
 5,085,331 A 2/1992 Groya

5,103,989 A 4/1992 Druesne  
 5,123,561 A 6/1992 Gross  
 5,145,088 A 9/1992 Goujon  
 5,195,645 A 3/1993 Schuermann  
 5,211,301 A 5/1993 Groya  
 5,219,087 A 6/1993 Christensson  
 5,219,100 A 6/1993 Beck  
 5,301,827 A 4/1994 Valyi  
 5,303,839 A 4/1994 Blumenschein  
 5,307,948 A 5/1994 Blackburn  
 5,353,946 A 10/1994 Behrend  
 5,482,172 A 1/1996 Braddock  
 5,636,732 A 6/1997 Gilels  
 5,730,785 A 3/1998 Idol  
 5,897,036 A 4/1999 Decoster  
 6,068,153 A 5/2000 Young  
 6,196,412 B1 3/2001 Cattell  
 D442,086 S 5/2001 Mozes  
 D446,722 S 8/2001 Morrow  
 6,341,720 B1 1/2002 Schmit  
 D456,713 S 5/2002 Bried  
 6,422,411 B1 7/2002 Gray  
 D470,765 S 2/2003 Baker  
 D473,792 S 4/2003 Diefenbach  
 D474,402 S 5/2003 Baerenwald  
 6,561,391 B1 5/2003 Baker  
 6,575,323 B1 6/2003 Martin  
 D491,065 S 6/2004 Solowiejko  
 D492,200 S 6/2004 Solowiejko  
 D494,469 S 8/2004 Solowiejko  
 D494,812 S 8/2004 Tremblay  
 D495,256 S 8/2004 Solowiejko  
 D497,106 S 10/2004 Solowiejko  
 6,877,631 B1 4/2005 Thompson et al.  
 6,899,245 B1 5/2005 Nelson  
 7,021,482 B2 \* 4/2006 Solowiejko ..... B65D 21/022  
 220/254.2  
 D530,606 S 10/2006 Liebe  
 7,114,627 B2 10/2006 Solowiejko  
 D538,664 S 3/2007 Solowiejko  
 D539,647 S 4/2007 Solowiejko  
 D544,309 S \* 6/2007 Gutekunst ..... D7/591  
 7,258,255 B2 8/2007 Vogel  
 D557,979 S 11/2007 Charriez  
 D567,582 S 4/2008 Blum  
 D592,966 S 5/2009 Nissen  
 D599,203 S 9/2009 Wilson  
 D604,161 S 11/2009 Wilson  
 D615,862 S 5/2010 Wilson  
 8,113,377 B2 \* 2/2012 Solowiejko ..... B65D 21/022  
 206/503  
 8,286,817 B2 \* 10/2012 Wilson ..... B65D 47/0828  
 220/254.2  
 8,464,886 B2 6/2013 Fisher  
 8,793,968 B2 8/2014 Cronin  
 2001/0011649 A1 8/2001 Fujie  
 2001/0035424 A1 11/2001 Combe  
 2002/0009524 A1 1/2002 Deering  
 2004/0079757 A1 4/2004 Ciccone  
 2004/0079765 A1 4/2004 Gallo  
 2005/0040168 A1 2/2005 Solowiejko  
 2005/0145628 A1 7/2005 Schwarz  
 2006/0144874 A1 7/2006 Solowiejko  
 2007/0000887 A1 1/2007 Caldwell  
 2007/0000953 A1 1/2007 Ranney  
 2007/0056972 A1 3/2007 Solowiejko  
 2007/0131639 A1 6/2007 Nakaya  
 2007/0170192 A1 7/2007 Blum  
 2009/0101645 A1 4/2009 Wilson  
 2009/0101647 A1 4/2009 Newberry  
 2009/0101674 A1 4/2009 Newberry  
 2010/0084399 A1 4/2010 Shieh  
 2011/0139783 A1 6/2011 Fisher  
 2011/0192847 A1 8/2011 Vandamme  
 2011/0239597 A1 10/2011 Wilson  
 2013/0186897 A1 7/2013 Luburic

\* cited by examiner

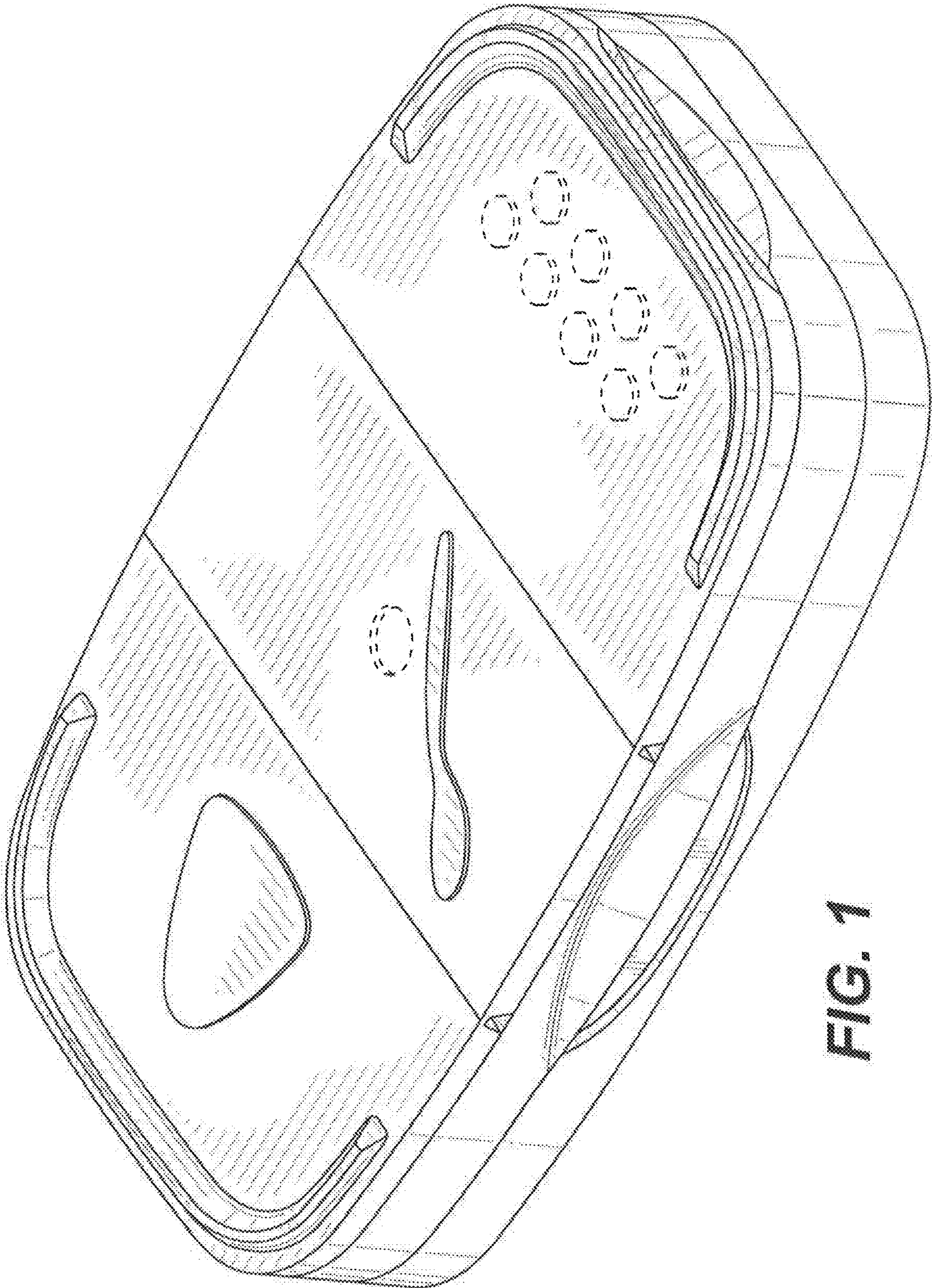

FIG. 1

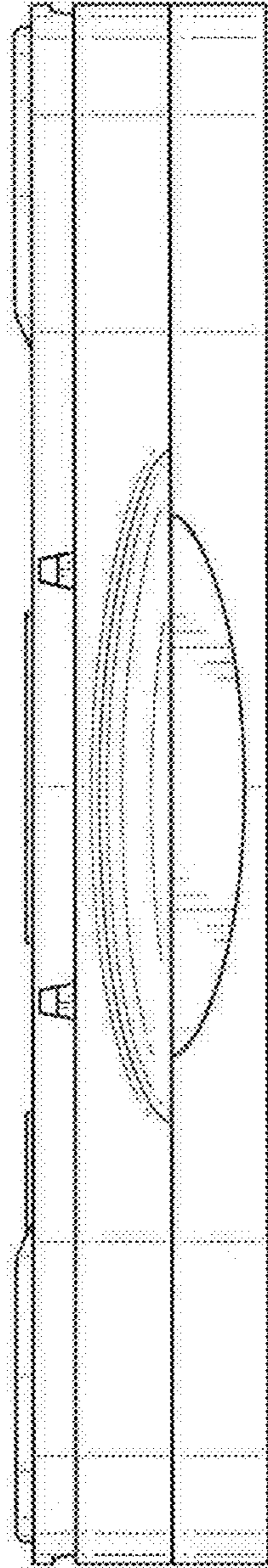

FIG. 2

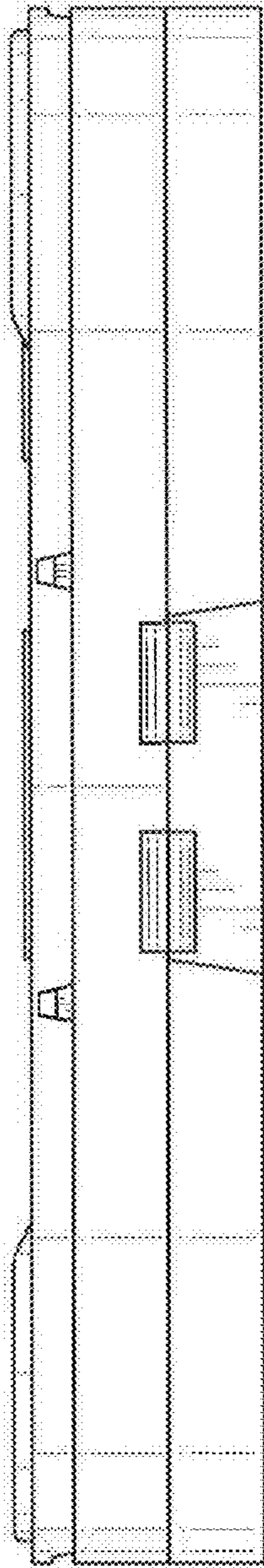

FIG. 3

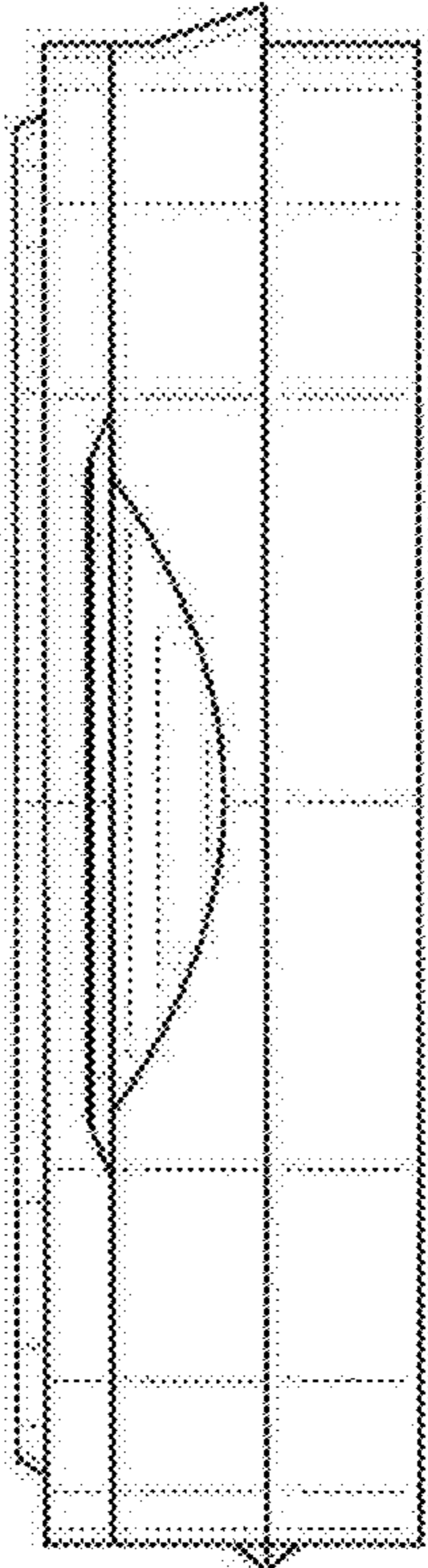

FIG. 4

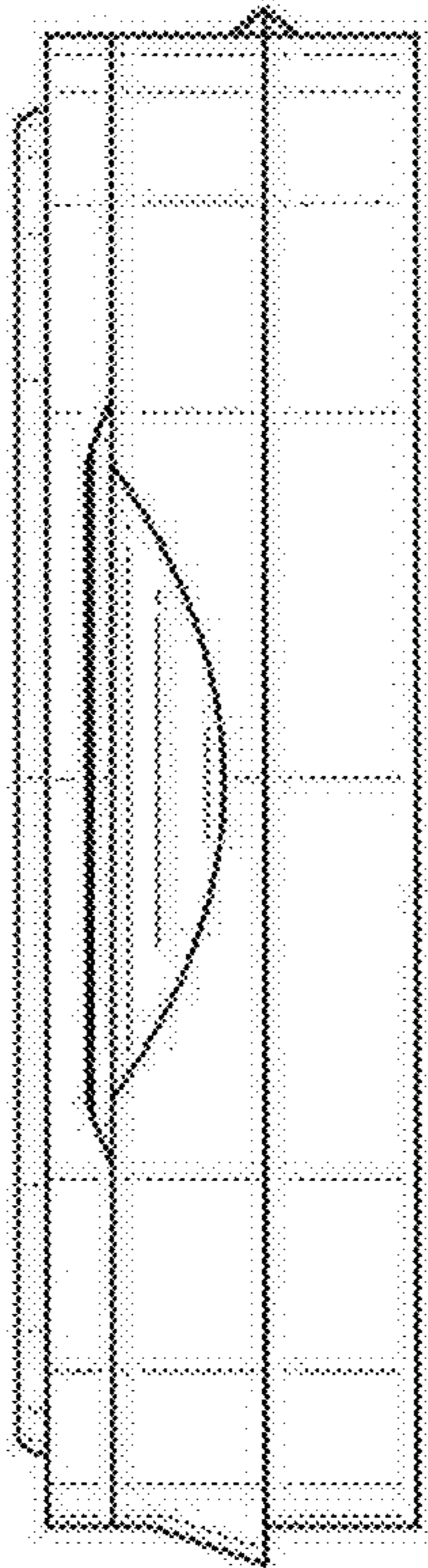

FIG. 5

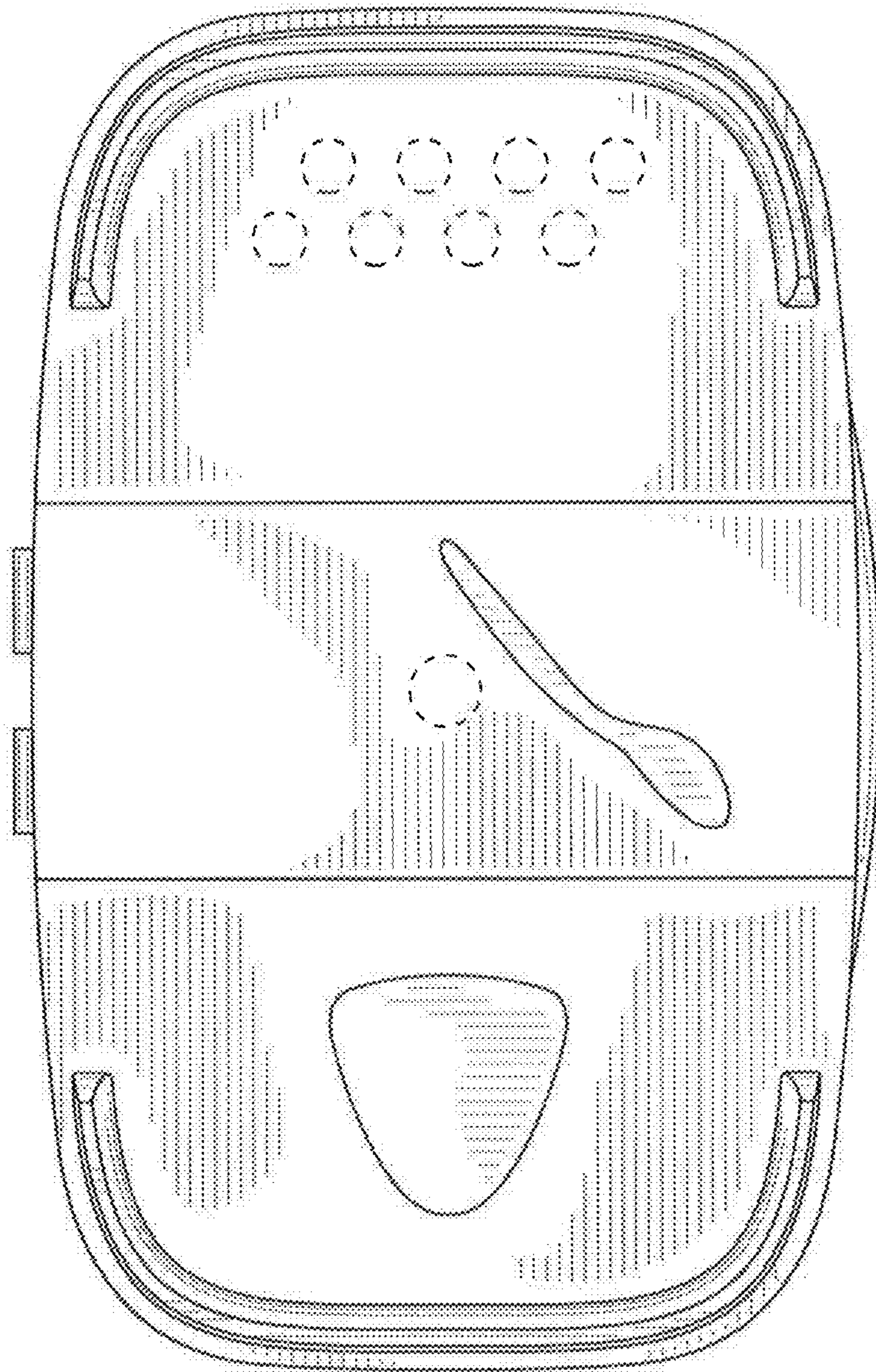

FIG. 6



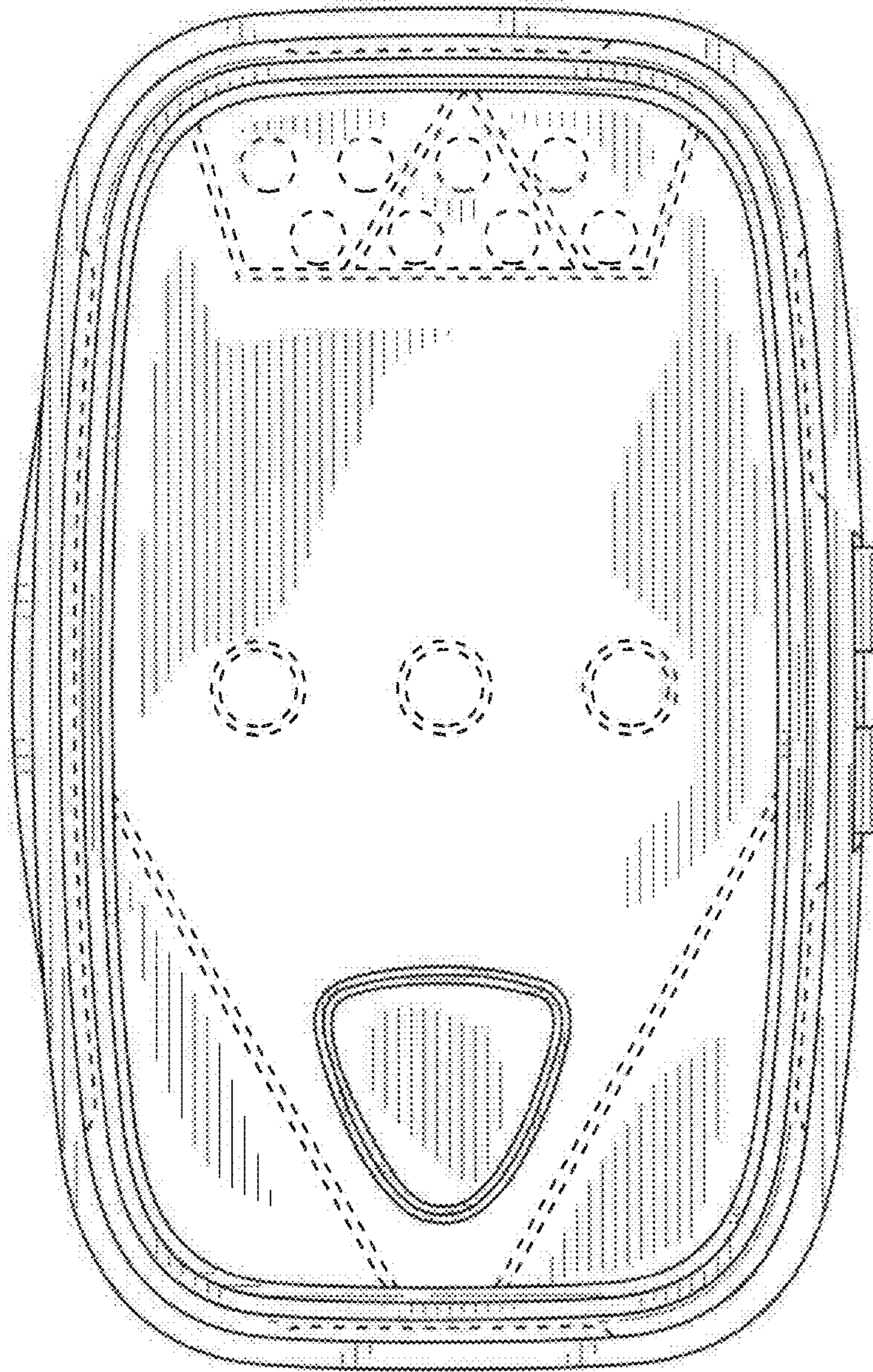

FIG. 7

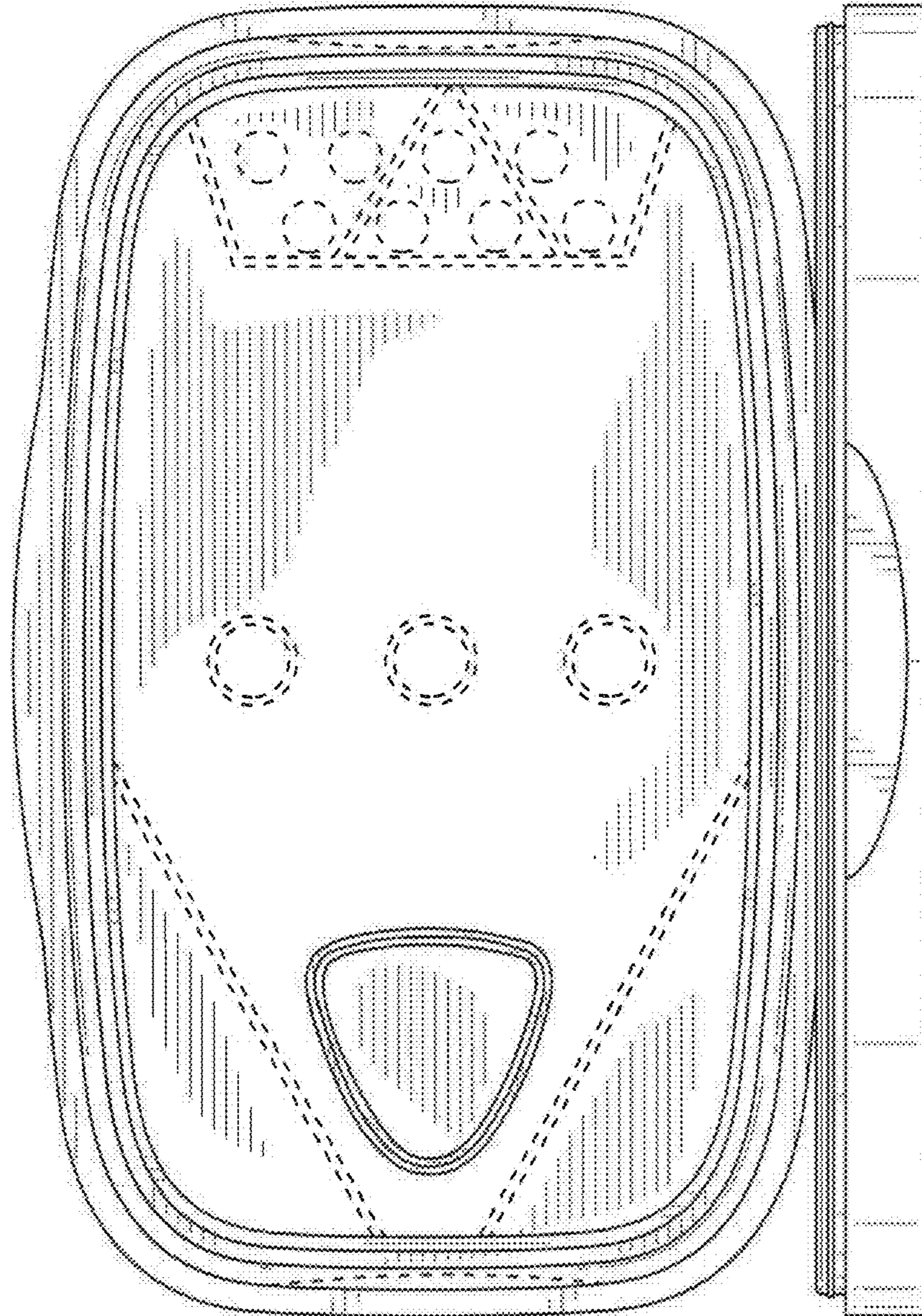

FIG. 8

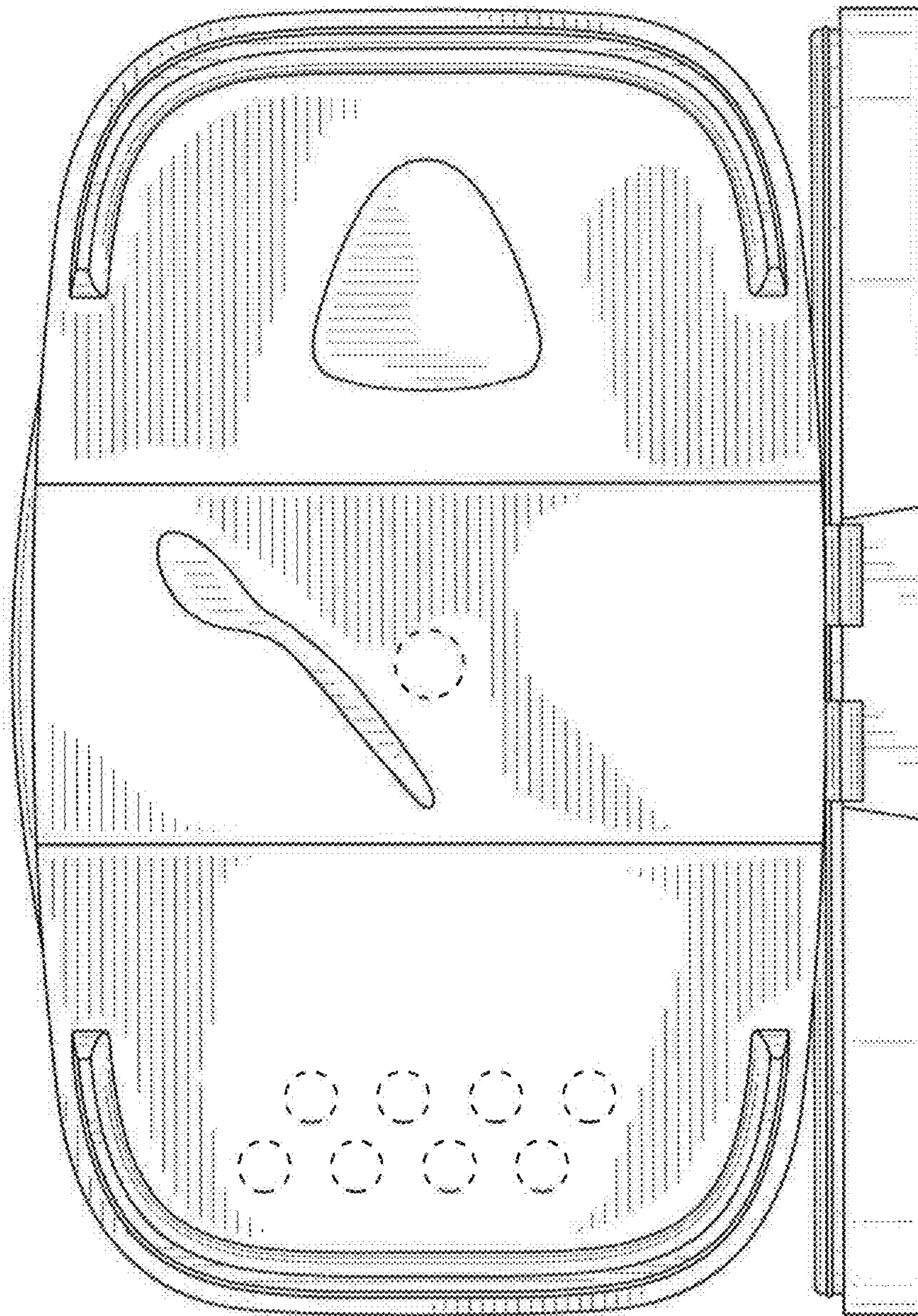

FIG. 9

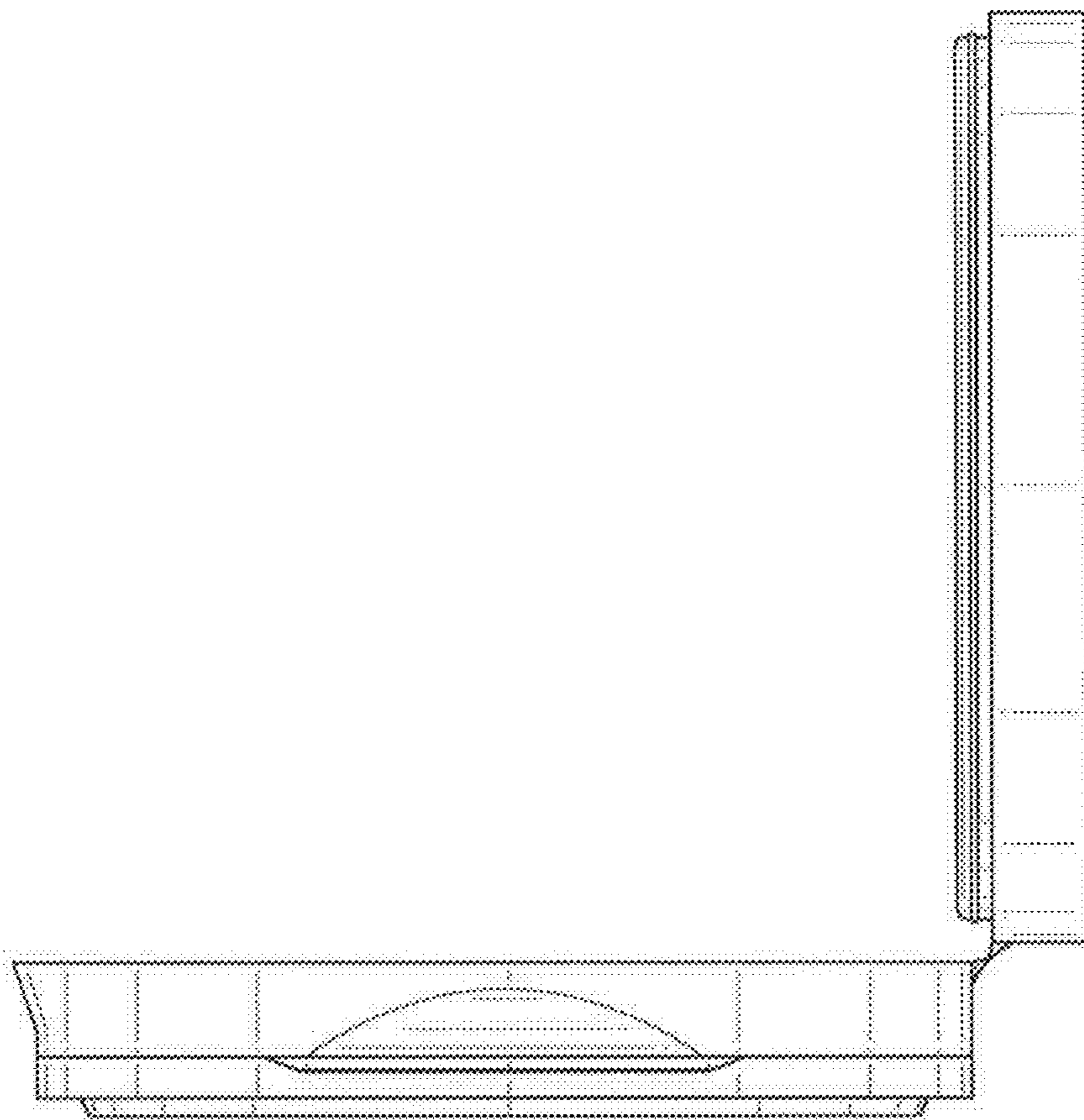

FIG. 10

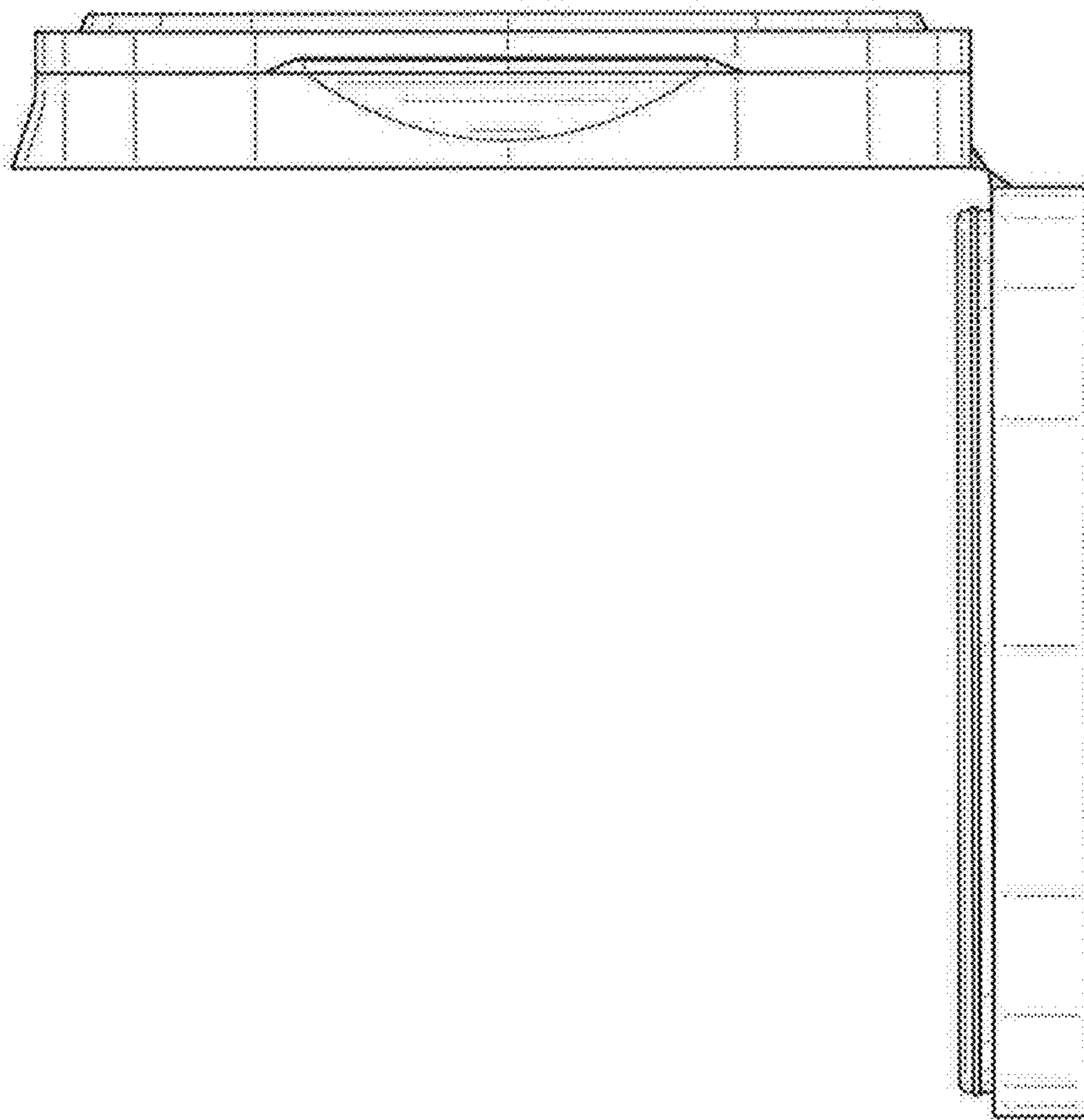

FIG. 11

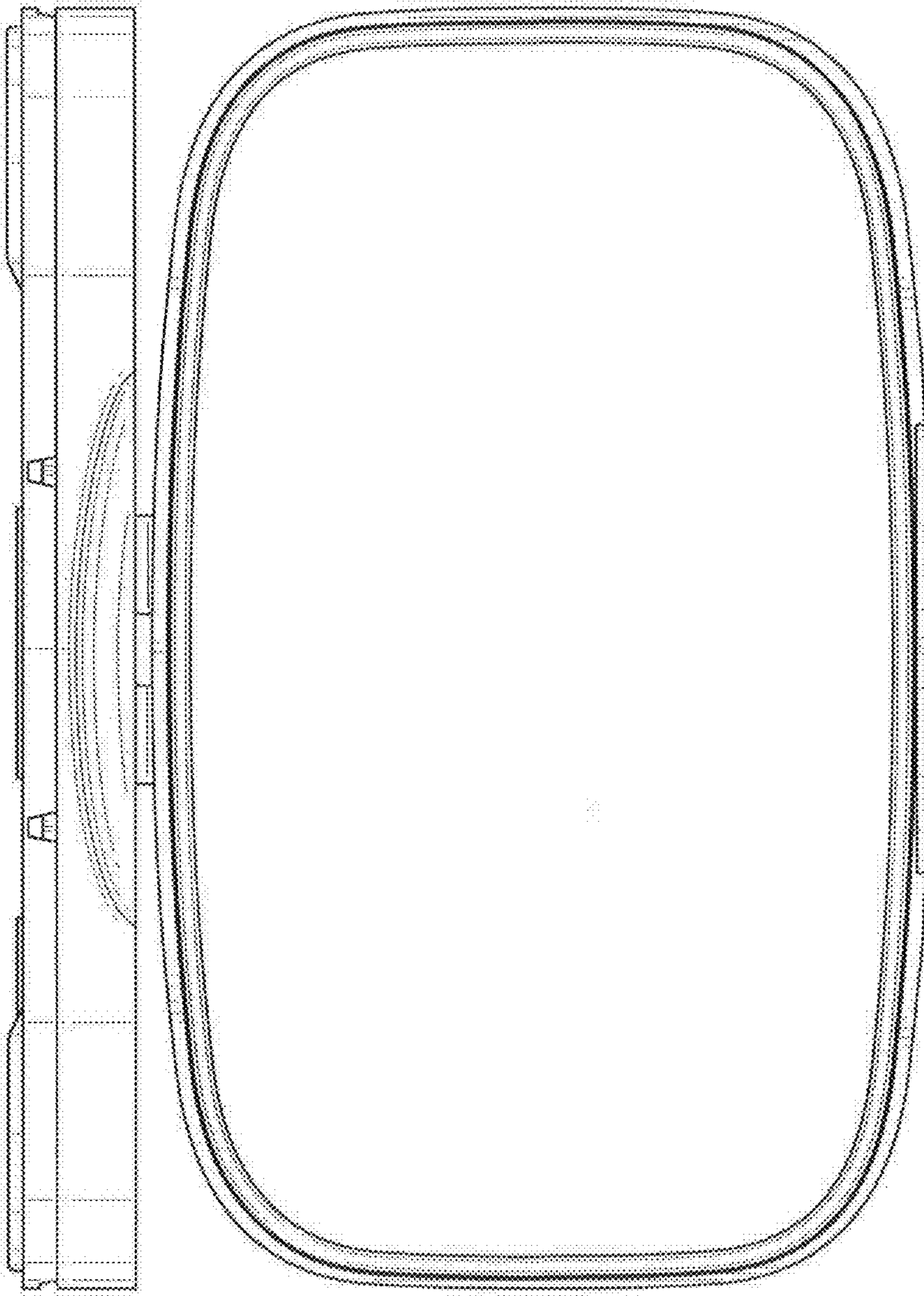

FIG. 12

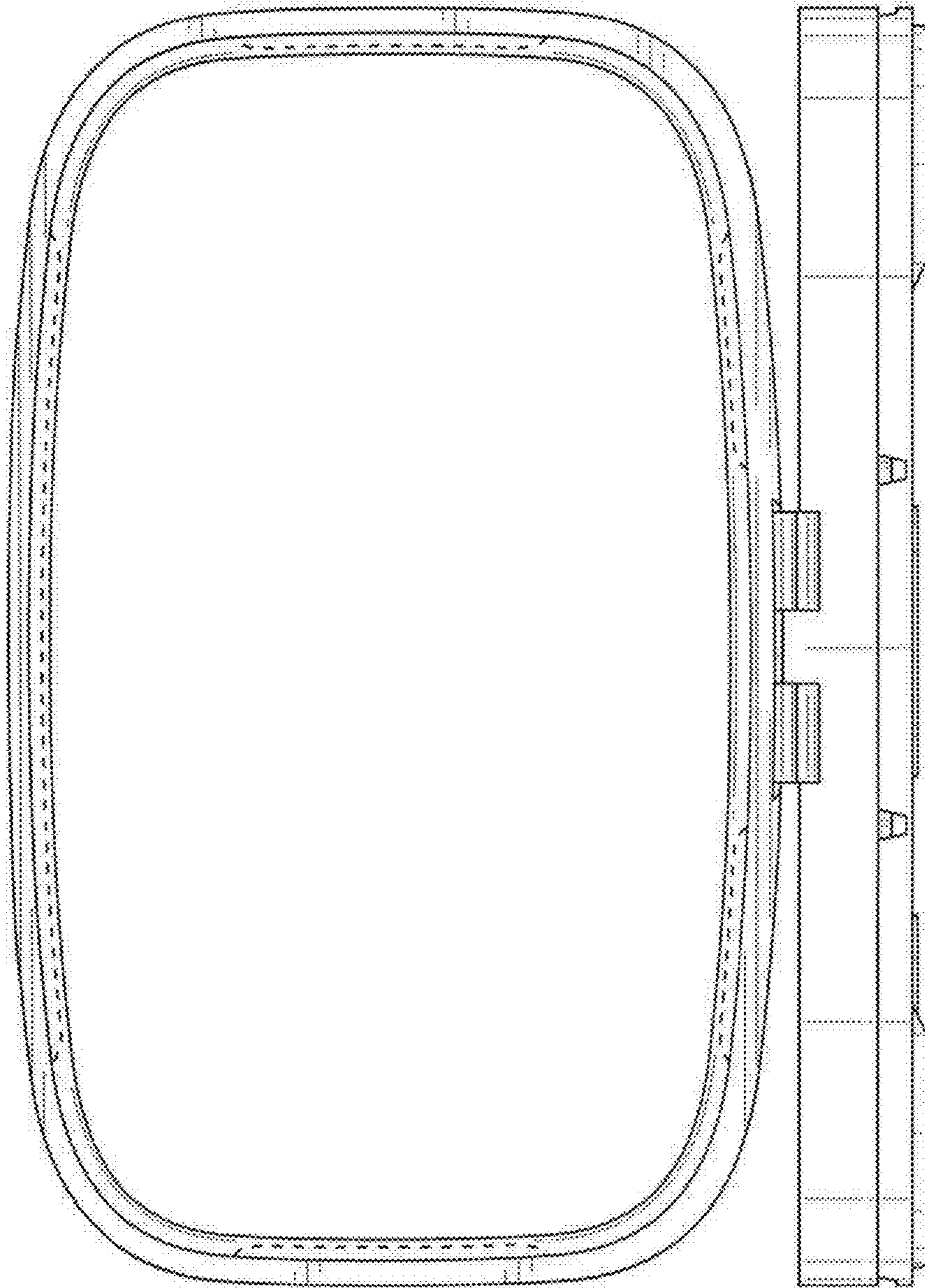

FIG. 13

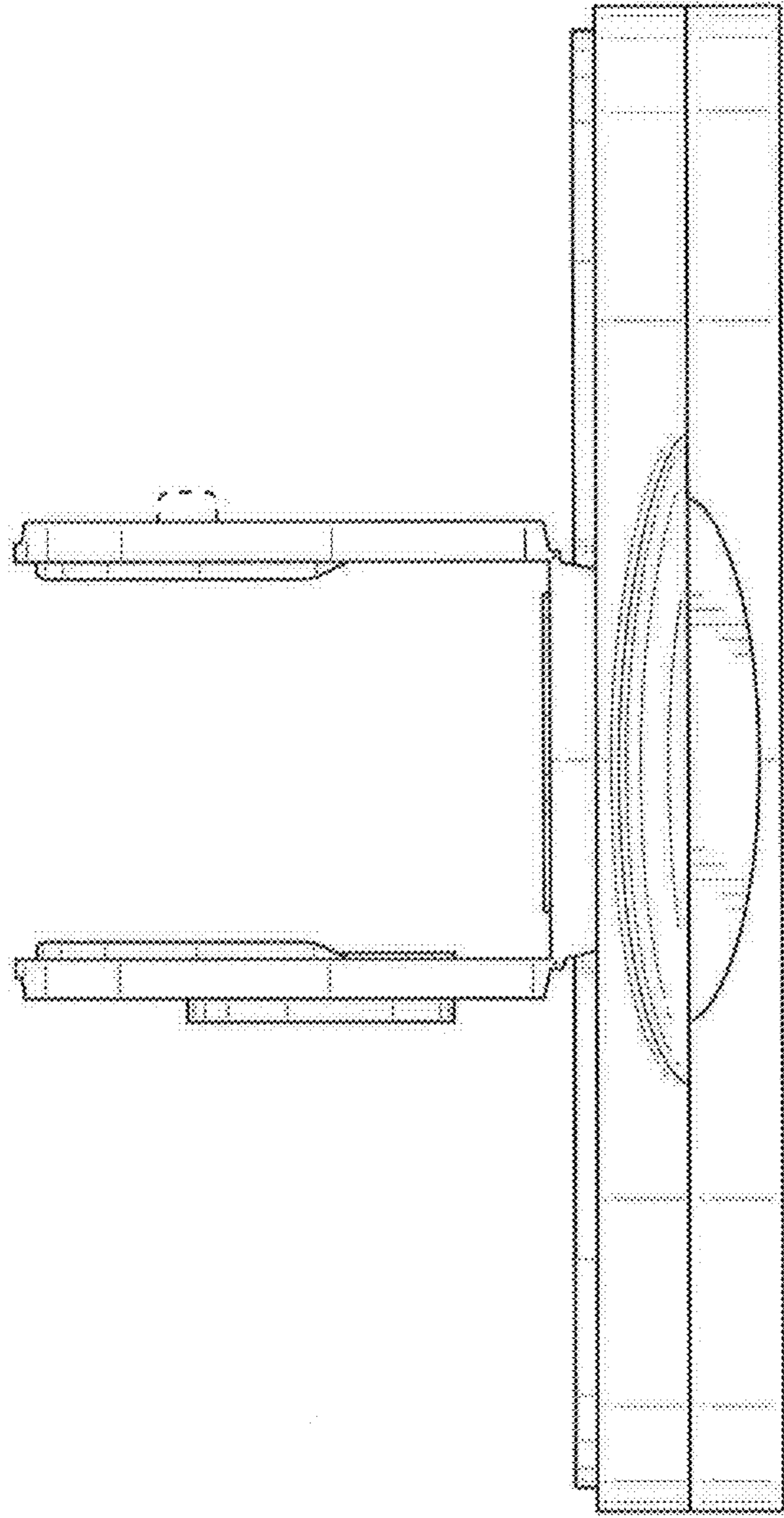

FIG. 14



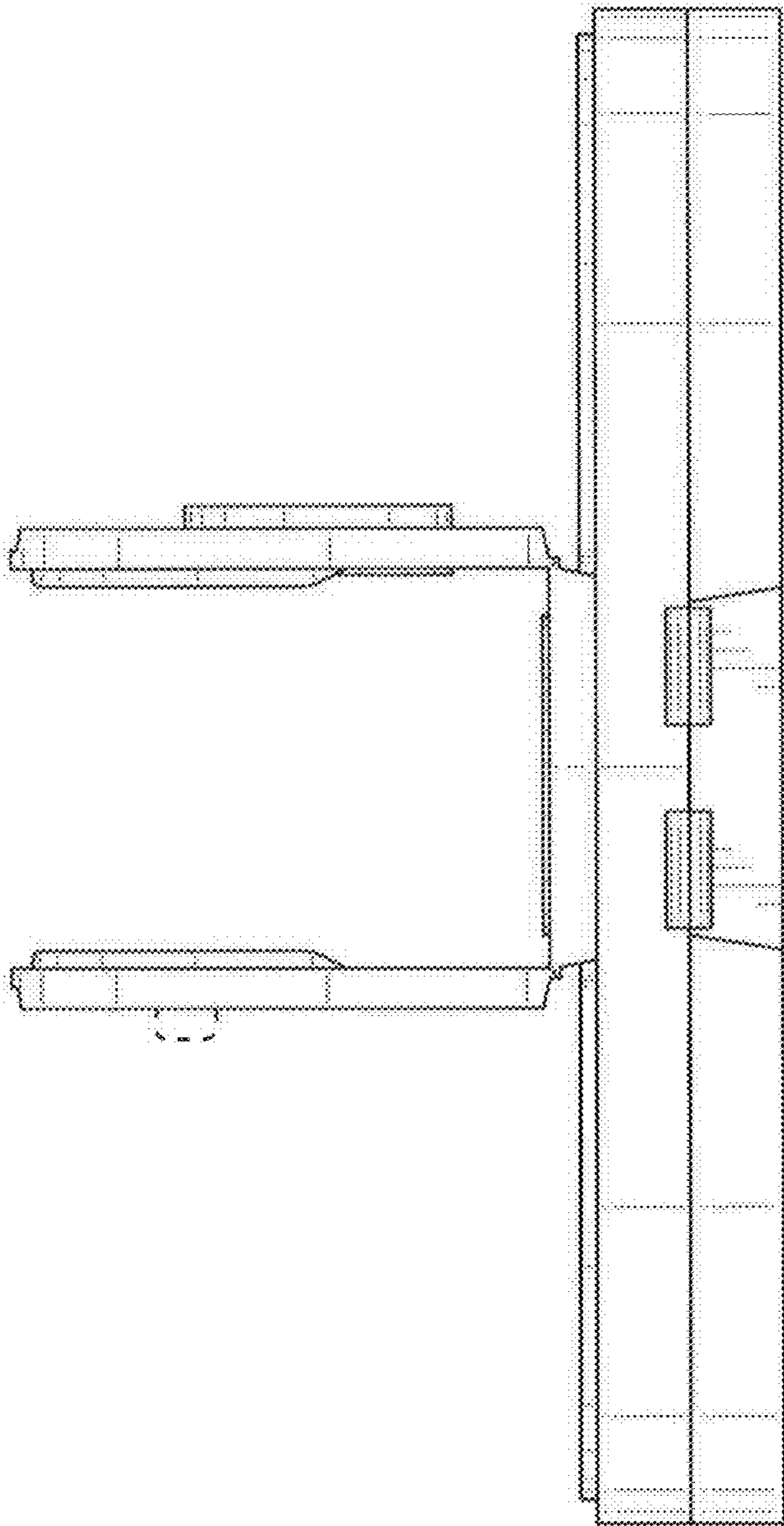

FIG. 15

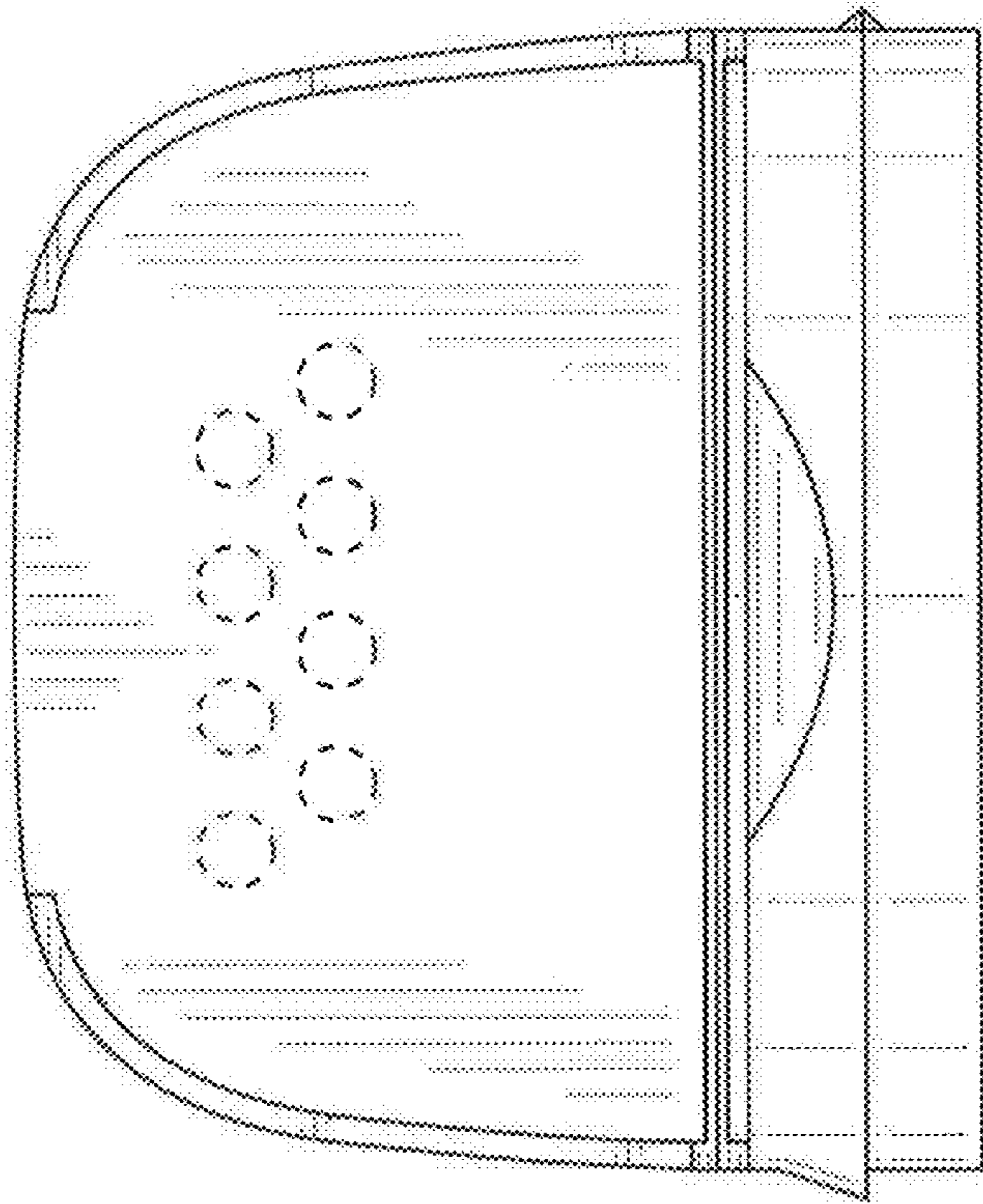

FIG. 16

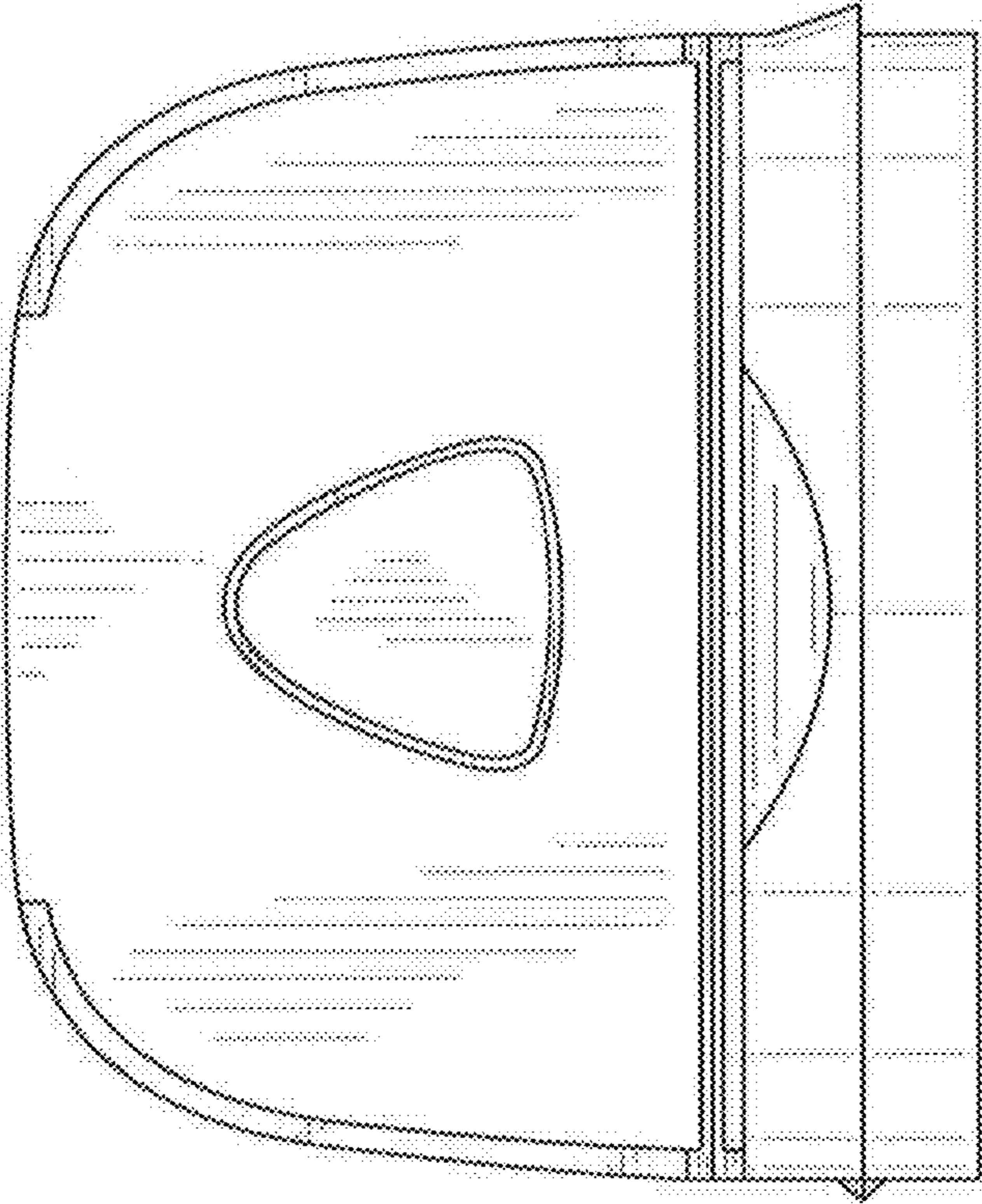

FIG. 17

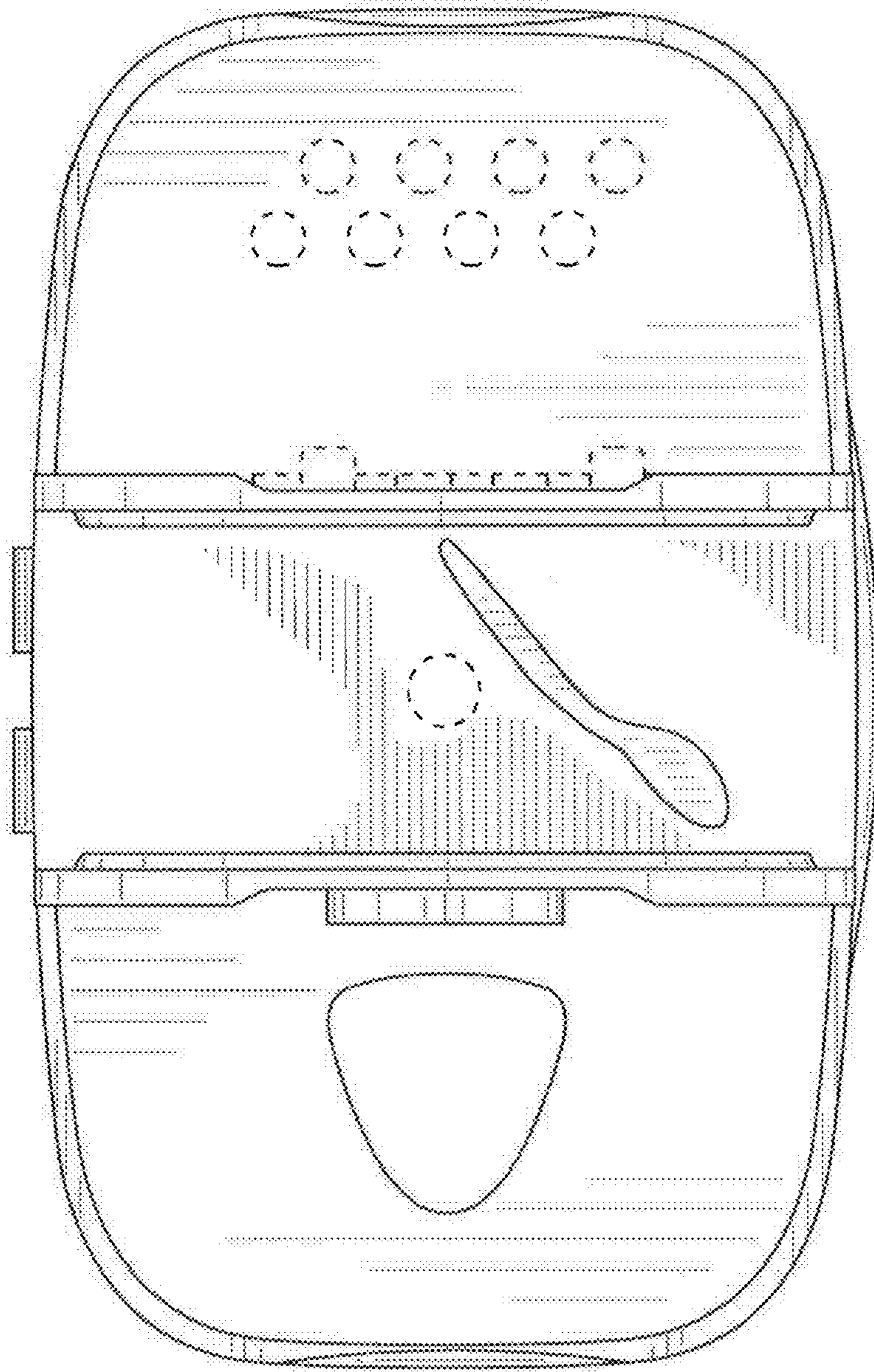

FIG. 18

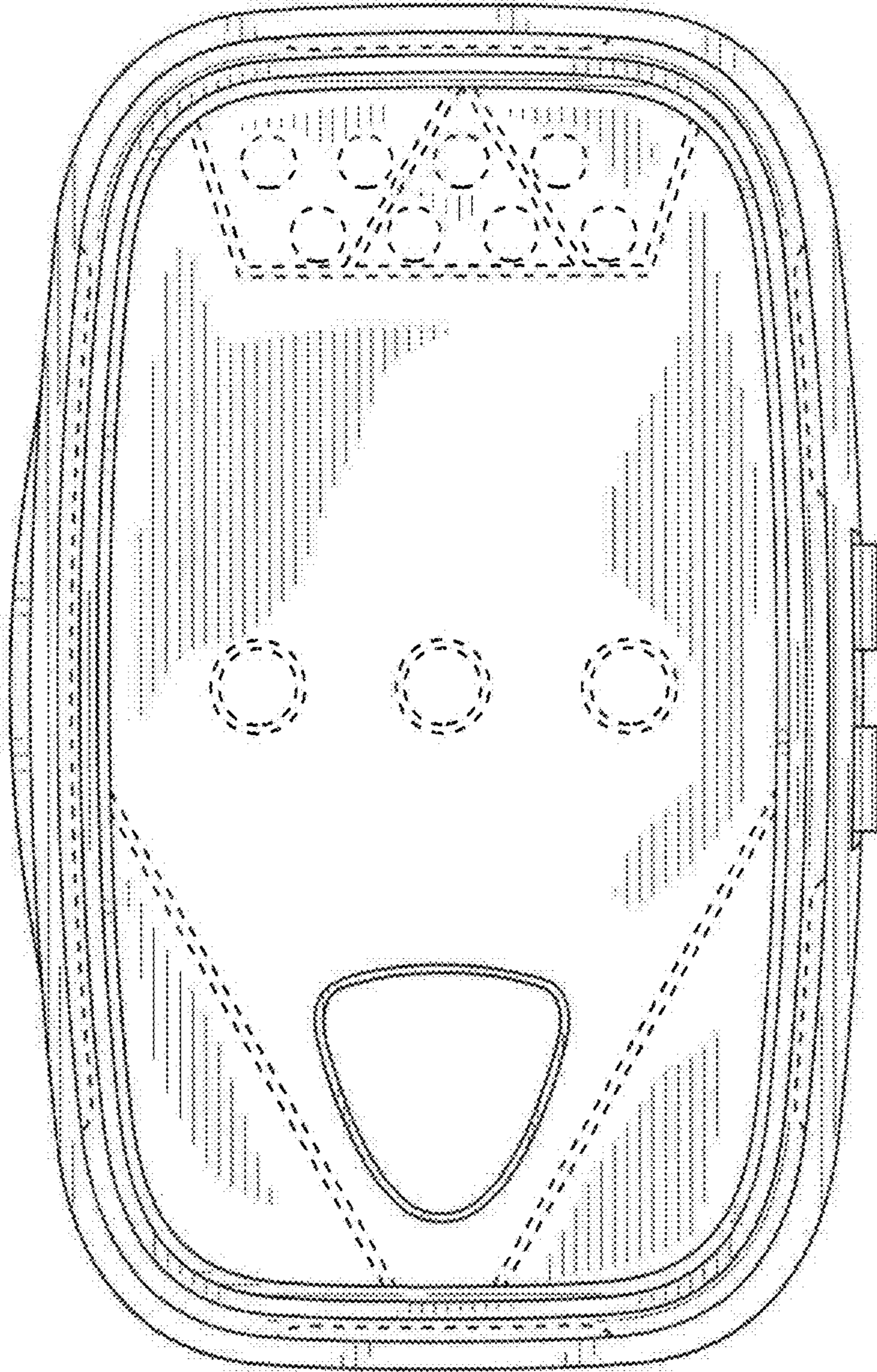
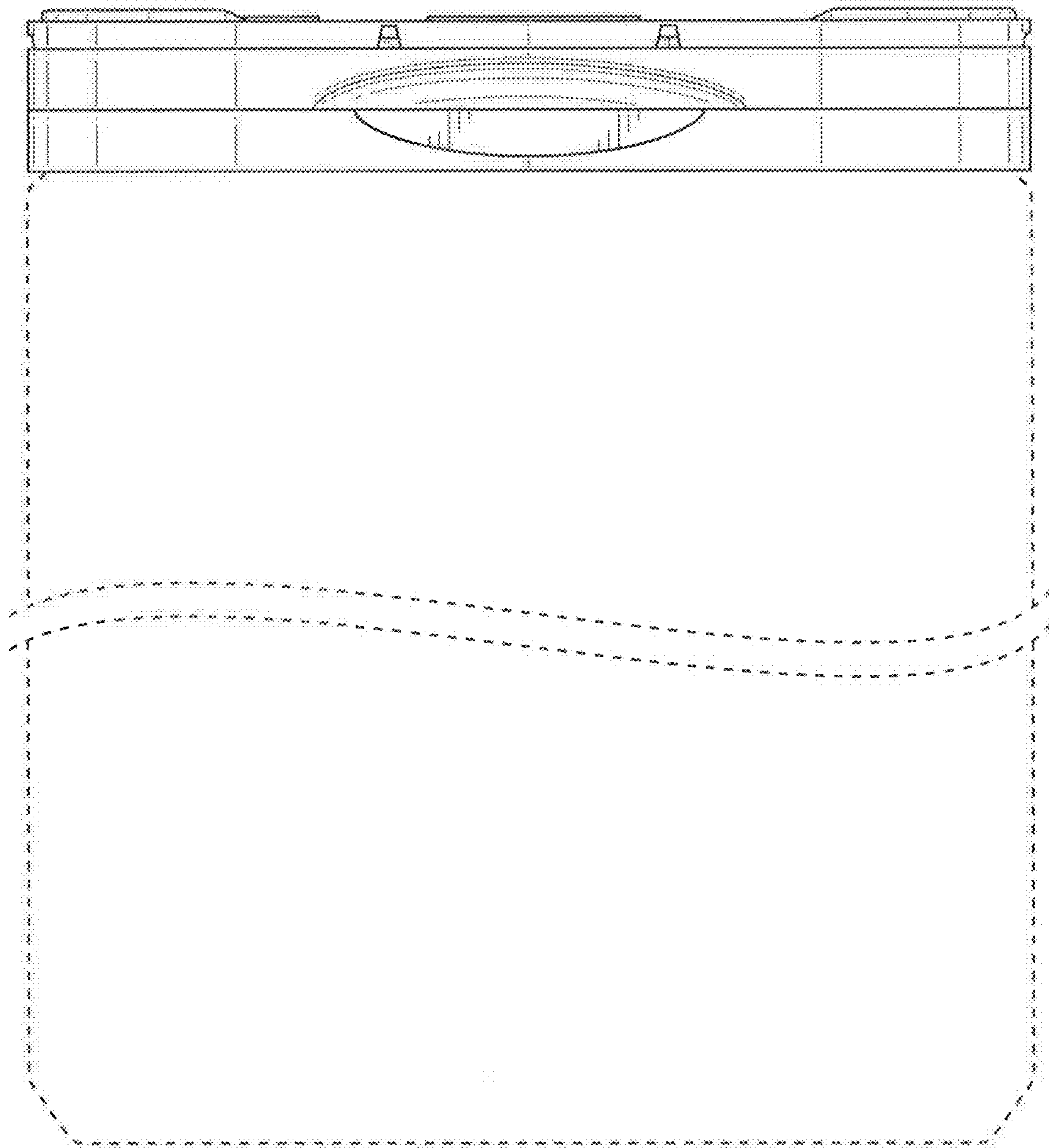

FIG. 19



**FIG. 20**