



US00D850839S

(12) **United States Design Patent**  
**Hardy et al.**

(10) **Patent No.:** **US D850,839 S**  
(45) **Date of Patent:** **\*\* Jun. 11, 2019**

(54) **BEVERAGE DISPENSER**

D676,700 S \* 2/2013 Chung ..... D7/307  
D738,667 S \* 9/2015 Bristol ..... D7/307  
D751,849 S \* 3/2016 Dunham ..... D7/307

(71) Applicant: **The Coca-Cola Company**, Atlanta, GA (US)

\* cited by examiner

(72) Inventors: **Jill Hardy**, Atlanta, GA (US); **Melinda Pritchett**, Lithonia, GA (US); **Philip A. Berger**, Floyds Knobs, IN (US); **Gregory A. Meyer**, Charlestown, IN (US); **Gregory K. Thompson**, Finchville, KY (US)

*Primary Examiner* — Derrick E Holland

*Assistant Examiner* — Andrew Kerr

(74) *Attorney, Agent, or Firm* — Tiffany N. Logan; Parks IP Law LLC

(73) Assignee: **The Coca-Cola Company**, Atlanta, GA (US)

(57) **CLAIM**

We claim the ornamental design for a beverage dispenser, as shown and described.

(\*\*) Term: **15 Years**

(21) Appl. No.: **29/604,681**

(22) Filed: **May 19, 2017**

**DESCRIPTION**

(51) **LOC (11) Cl.** ..... **07-01**

(52) **U.S. Cl.**

USPC ..... **D7/307**

(58) **Field of Classification Search**

USPC ..... D7/300, 306–311

CPC ..... A47J 31/00; B67D 1/0041

See application file for complete search history.

FIG. 1 is a perspective view of a beverage dispenser, showing our new design;

FIG. 2 is a right view thereof;

FIG. 3 is a left view thereof;

FIG. 4 is a front view thereof;

FIG. 5 is a back view thereof;

FIG. 6 is a top view thereof; and,

FIG. 7 is a bottom view thereof.

The broken lines showing portions of the beverage dispenser are for the purpose of illustrating environmental structure only and forms no part of the claimed design.

(56) **References Cited**

U.S. PATENT DOCUMENTS

D304,989 S \* 12/1989 Fossella ..... D7/308

D598,232 S \* 8/2009 Adachi ..... D7/307

**1 Claim, 7 Drawing Sheets**

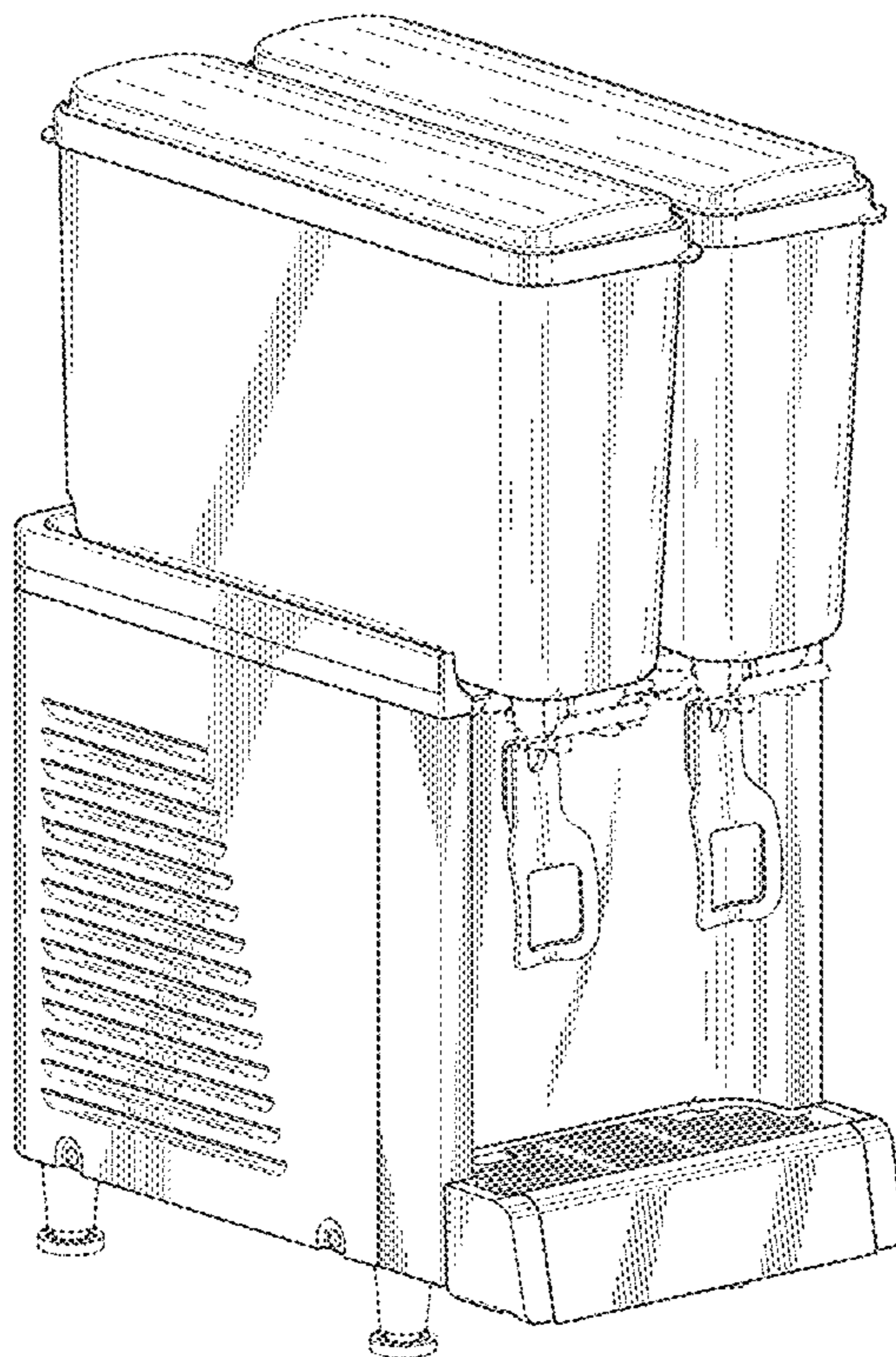

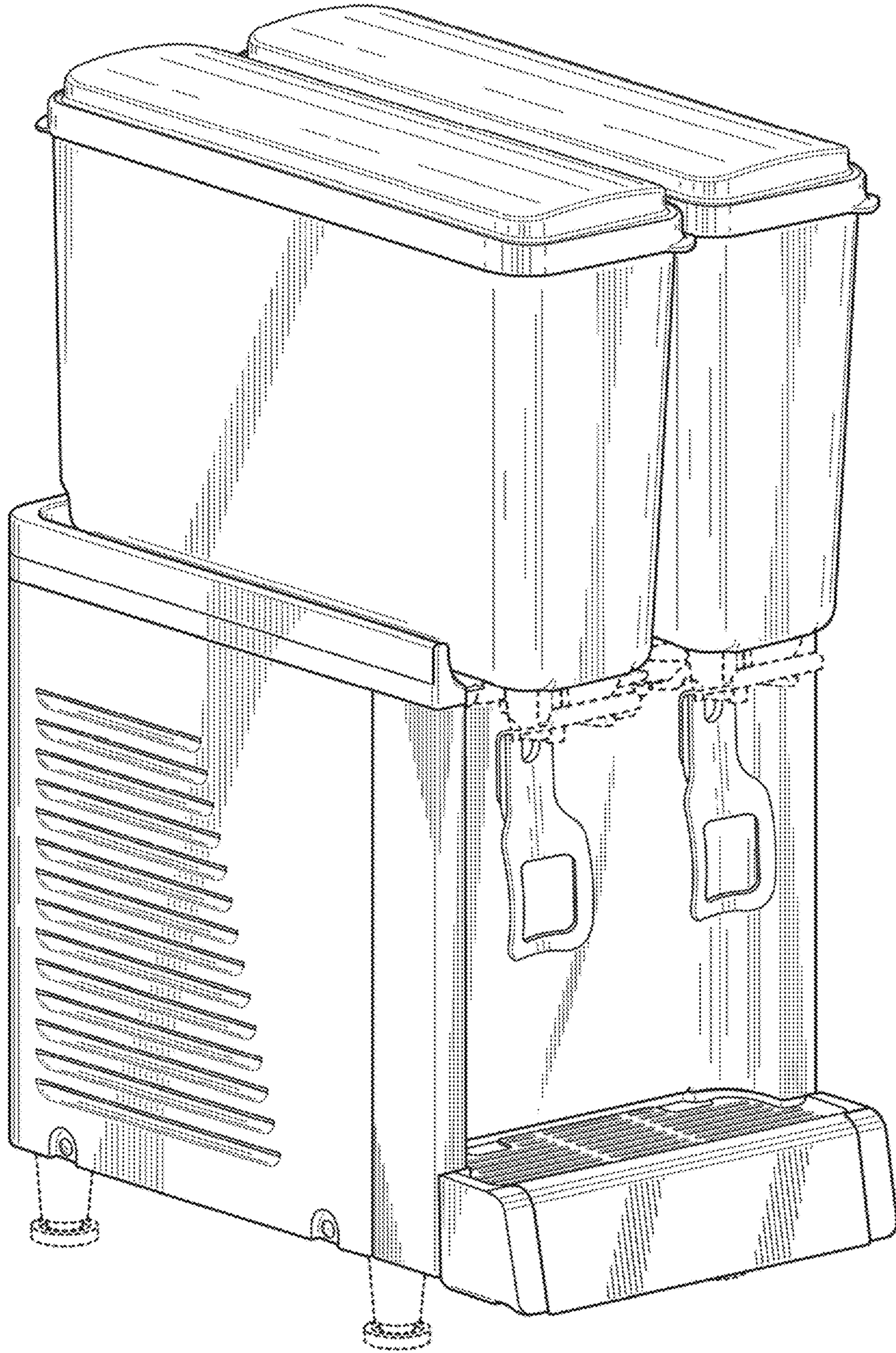

FIG. 1

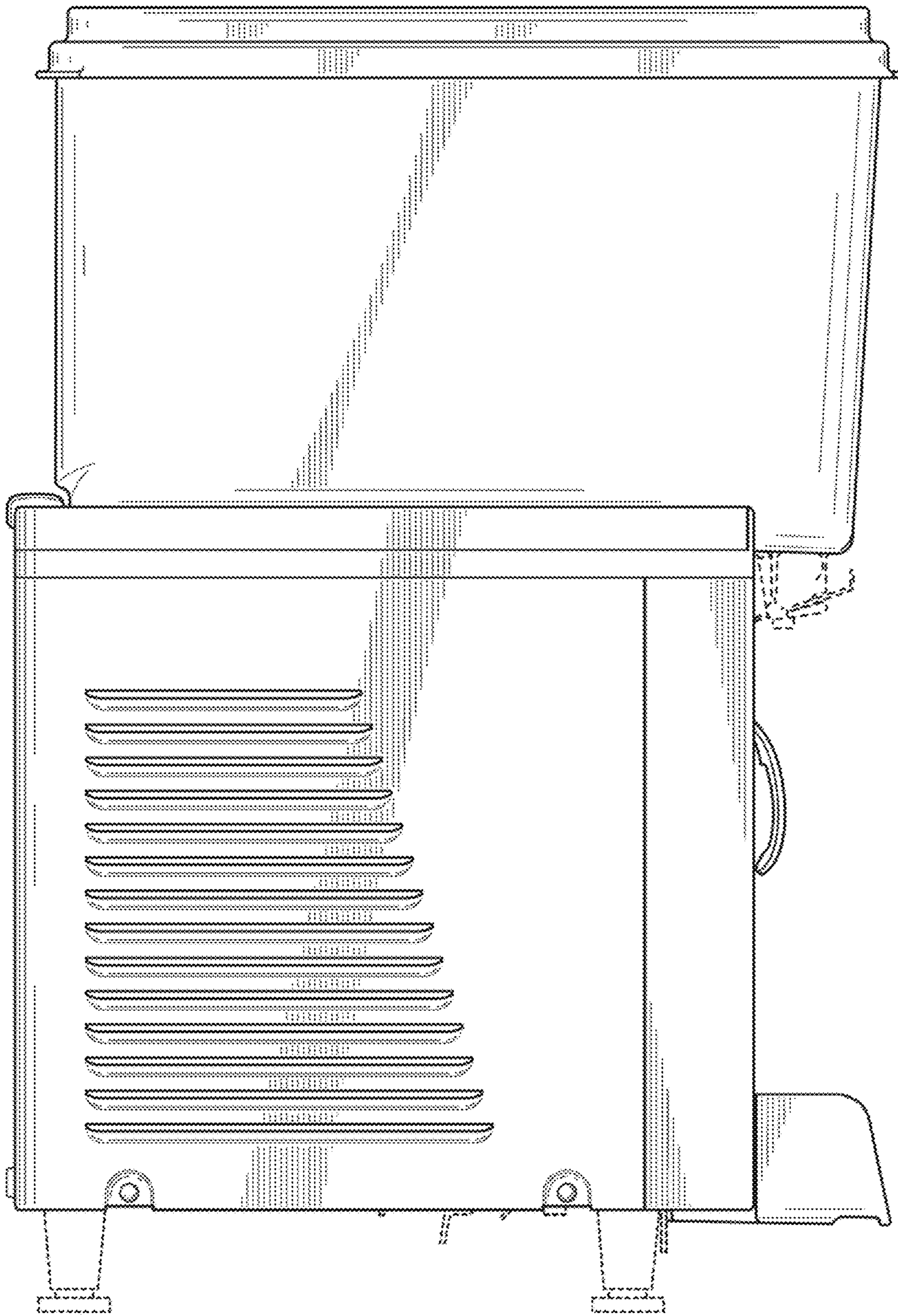

FIG. 2

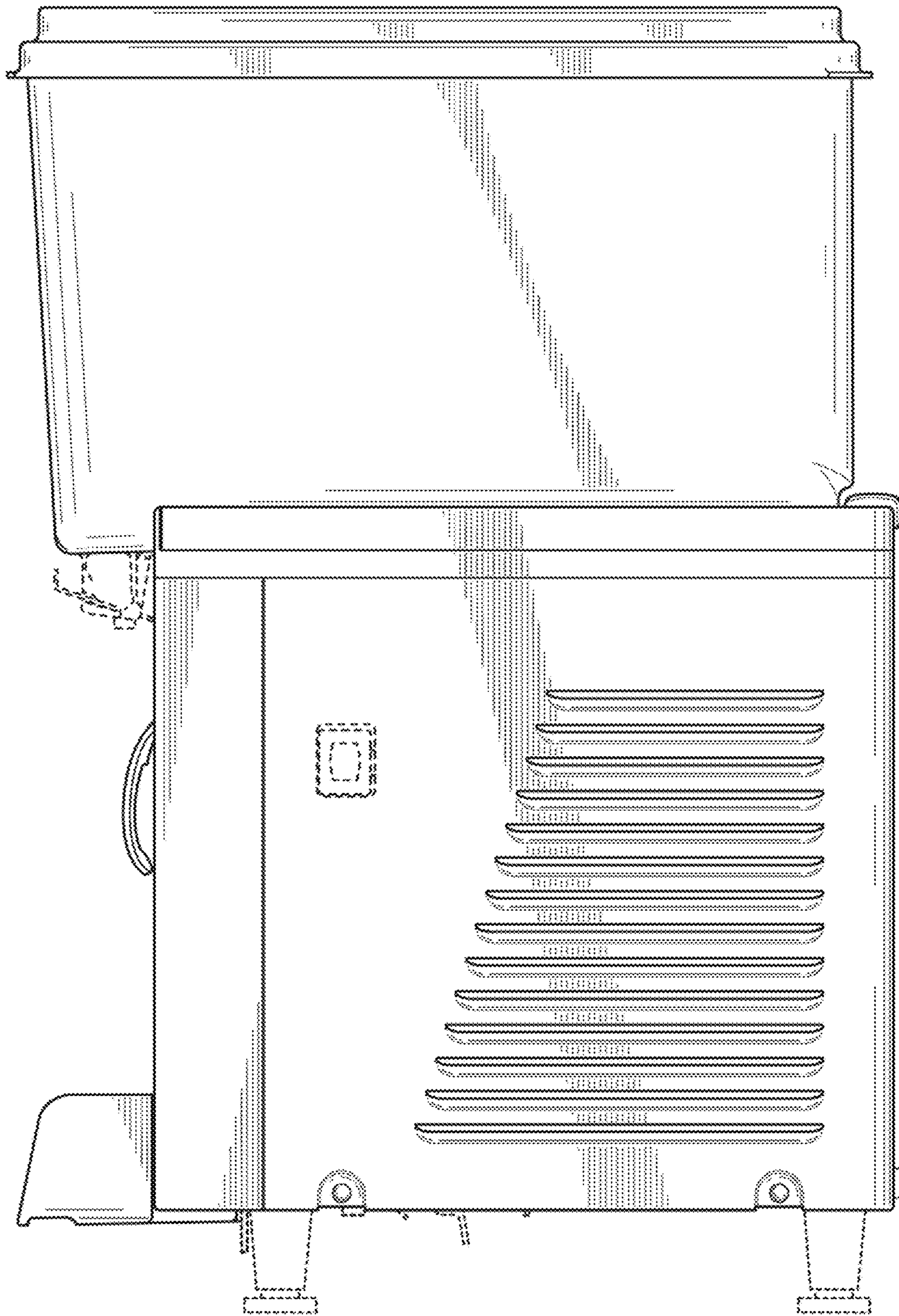

FIG. 3

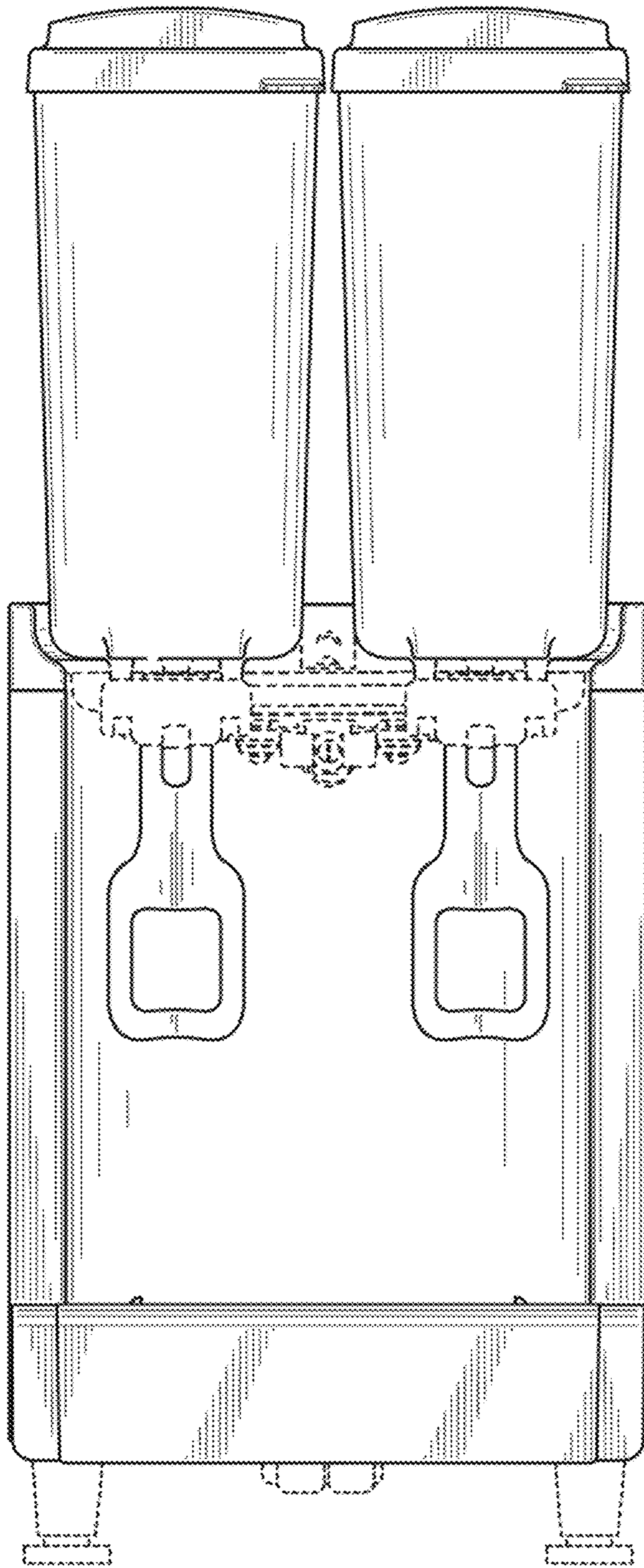

FIG. 4

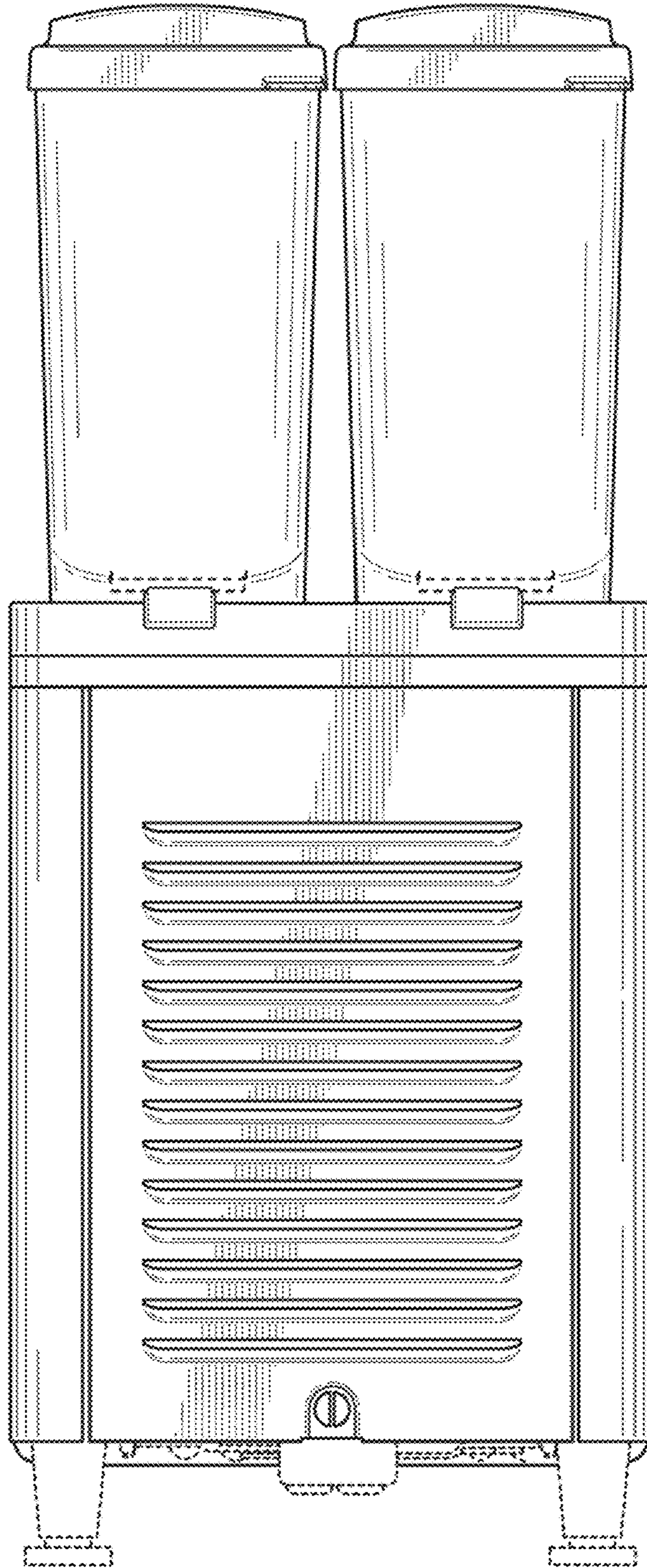

FIG. 5

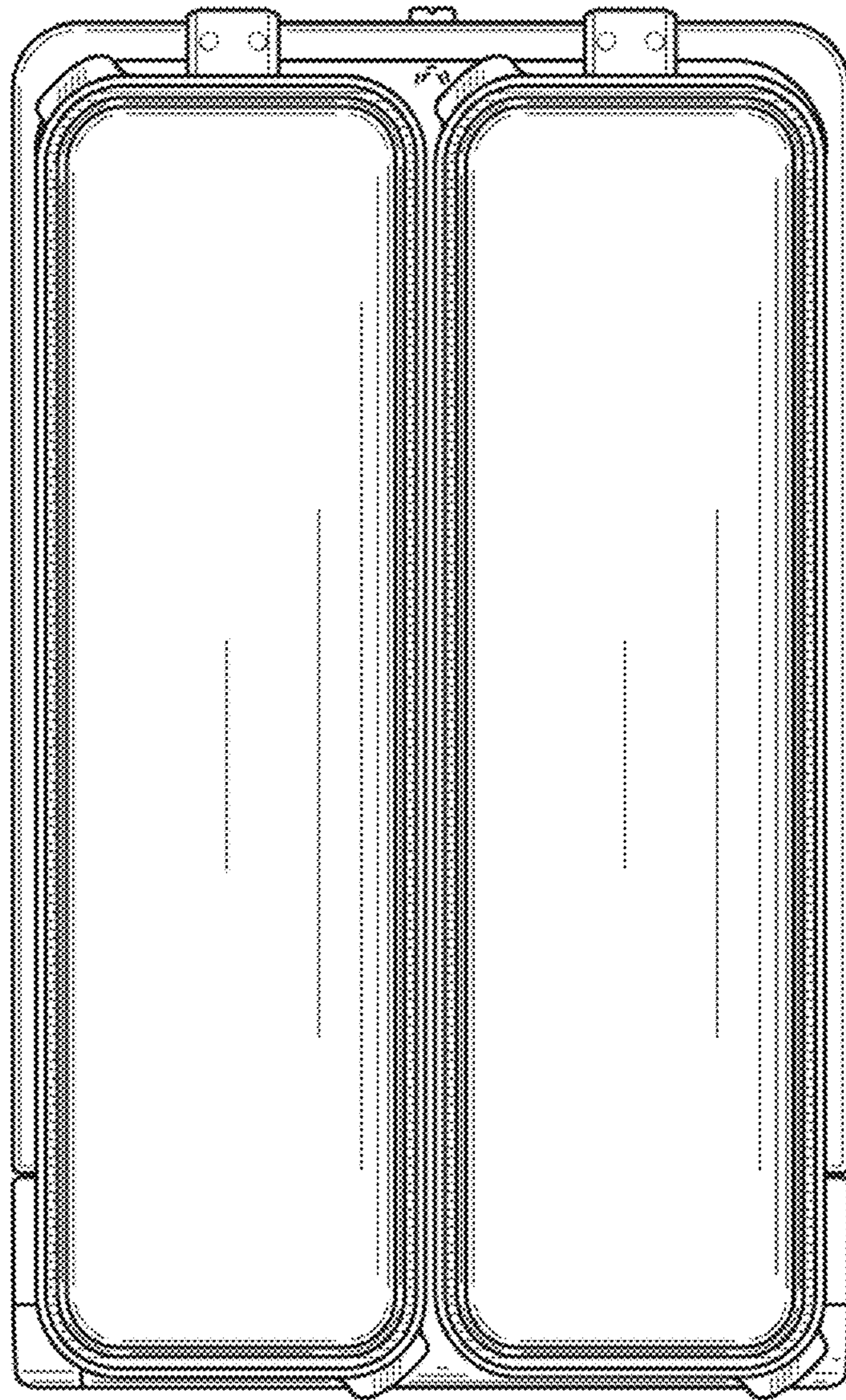

FIG. 6

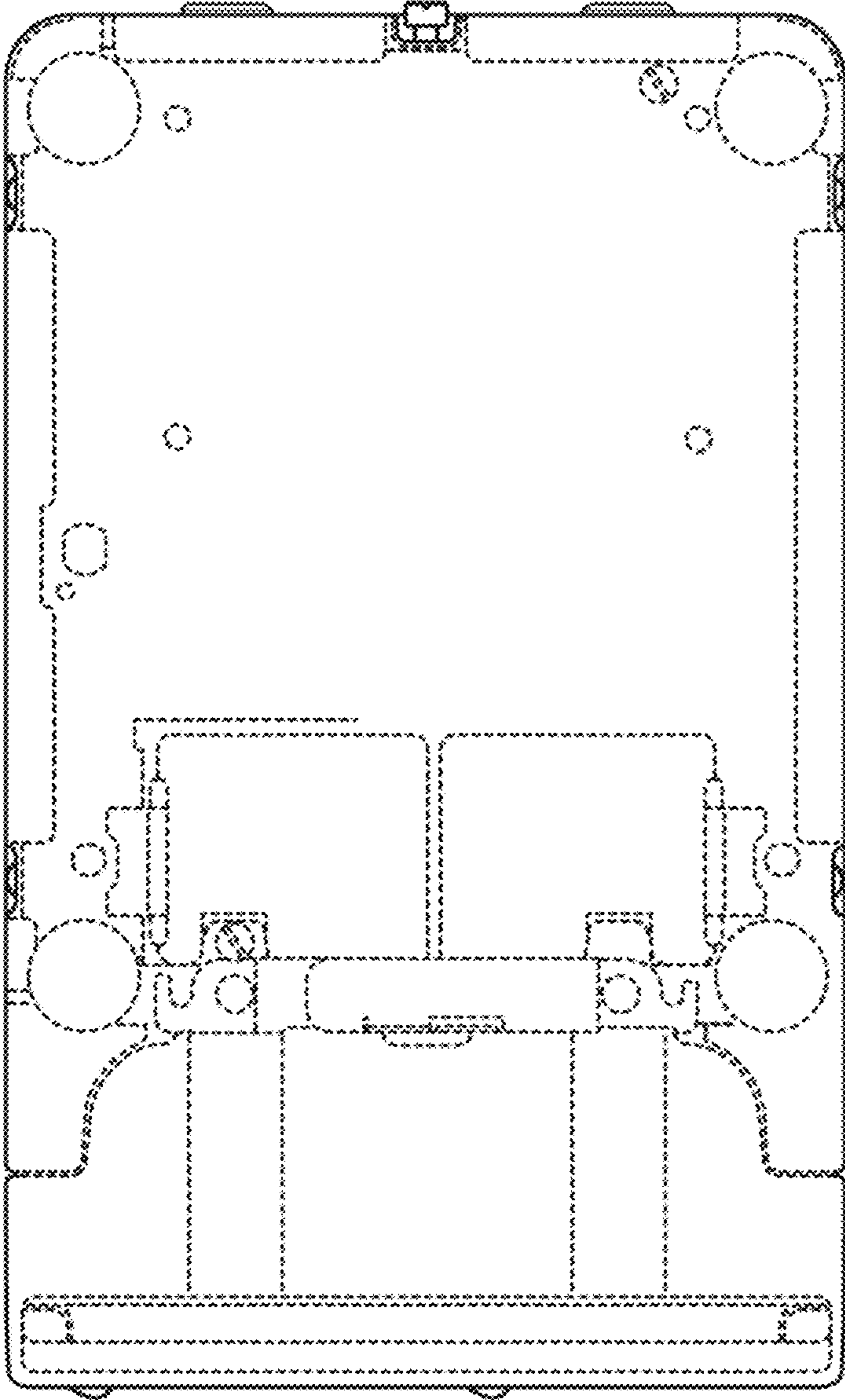

FIG. 7