



US00D850732S

(12) **United States Design Patent**  
**Dong**

(10) **Patent No.:** **US D850,732 S**  
(45) **Date of Patent:** **\*\* Jun. 4, 2019**

(54) **STOP BARKING DEVICE**

(71) Applicant: **Fuliang Dong**, Shenzhen (CN)

(72) Inventor: **Fuliang Dong**, Shenzhen (CN)

(\*\*) Term: **15 Years**

(21) Appl. No.: **29/636,755**

(22) Filed: **Feb. 11, 2018**

(51) **LOC (11) Cl.** ..... **30-04**

(52) **U.S. Cl.**

USPC ..... **D30/152**; D30/199

(58) **Field of Classification Search**

USPC ..... D30/151-155, 144, 199, 160;  
119/792-798, 850, 855-859, 863-865,  
119/654, 905, 907, 815, 712, 802, 784,  
119/769, 760, 776, 862, 908, 860,  
119/719-721; 242/381.1-381.2, 385.4,  
242/378.3, 376.1, 385.1, 916, 601, 570,  
242/405, 404, 371, 223, 170, 388.1,  
242/405.2, 377, 381.3, 381.6, 405.3,  
242/388.6, 384.7, 382, 396.1, 404.1, 380;  
362/108; 33/767, 769, 414; D12/400;  
D3/229, 230, 207, 208, 215; 40/1.5, 455,  
40/640, 303; 206/63.3, 459.5, 702, 408;  
D6/515; D8/358, 360, 347, 360.1, 359,  
D8/356, DIG. 1; D24/145; D10/57, 104,  
D10/72, 106, 104.1, 104.2, 32, 38;  
D20/28; 224/666, 678; 16/445; 283/74,  
283/70; D11/232, 200, 216, 1, 2, 3, 4,  
D11/86, 87, 201, 206-210, 212-215, 218;  
24/163 K, 122.3, 323, 702, 600.4-600.7,  
24/163 R, 169-171, 173, 177-179, 191,  
24/194, 195, 197, 200, 303, 616, 635,  
24/313, 615, 3, 6, 3 K, 599.2, 96, 221,  
24/237, 311, 312, 314, 321, 338, 339,  
24/309; 428/3, 4; 54/76, 1, 71; 63/29.1,  
63/3; 191/12.2 R, 12.4; D13/154, 153,

D13/137.4, 155, 103; D19/69, 67;  
379/438; 446/26; 473/576; D22/140;  
174/135; 439/504, 13, 501; D34/33;  
(Continued)

(56) **References Cited**

U.S. PATENT DOCUMENTS

3,983,483 A \* 9/1976 Pando ..... H01Q 1/273  
455/90.2  
4,612,719 A \* 9/1986 de Jong ..... A01K 11/006  
119/859

(Continued)

*Primary Examiner* — Susan Moon Lee

(74) *Attorney, Agent, or Firm* — W&K IP

(57) **CLAIM**

The ornamental design for a stop barking device, as shown and described.

**DESCRIPTION**

FIG. 1 is a front view of a stop barking device;  
FIG. 2 is a back view thereof;  
FIG. 3 is a top plan view thereof;  
FIG. 4 is a bottom plan view thereof;  
FIG. 5 is a left side view thereof;  
FIG. 6 is a right side view thereof;  
FIG. 7 is a perspective view thereof;  
FIG. 8 is an enlarged partial front view of the device taken from the showing in FIG. 1;  
FIG. 9 is an enlarged partial rear view of the device taken from the showing in FIG. 2;  
FIG. 10 is an enlarged partial top view of the device taken from the showing in FIG. 3;  
FIG. 11 is an enlarged partial bottom view of the device taken from the showing in FIG. 4;  
FIG. 12 is an enlarged partial left side view of the device taken from the showing in FIG. 5; and,  
FIG. 13 is an enlarged partial right side view of the device taken from the showing in FIG. 6.

**1 Claim, 13 Drawing Sheets**

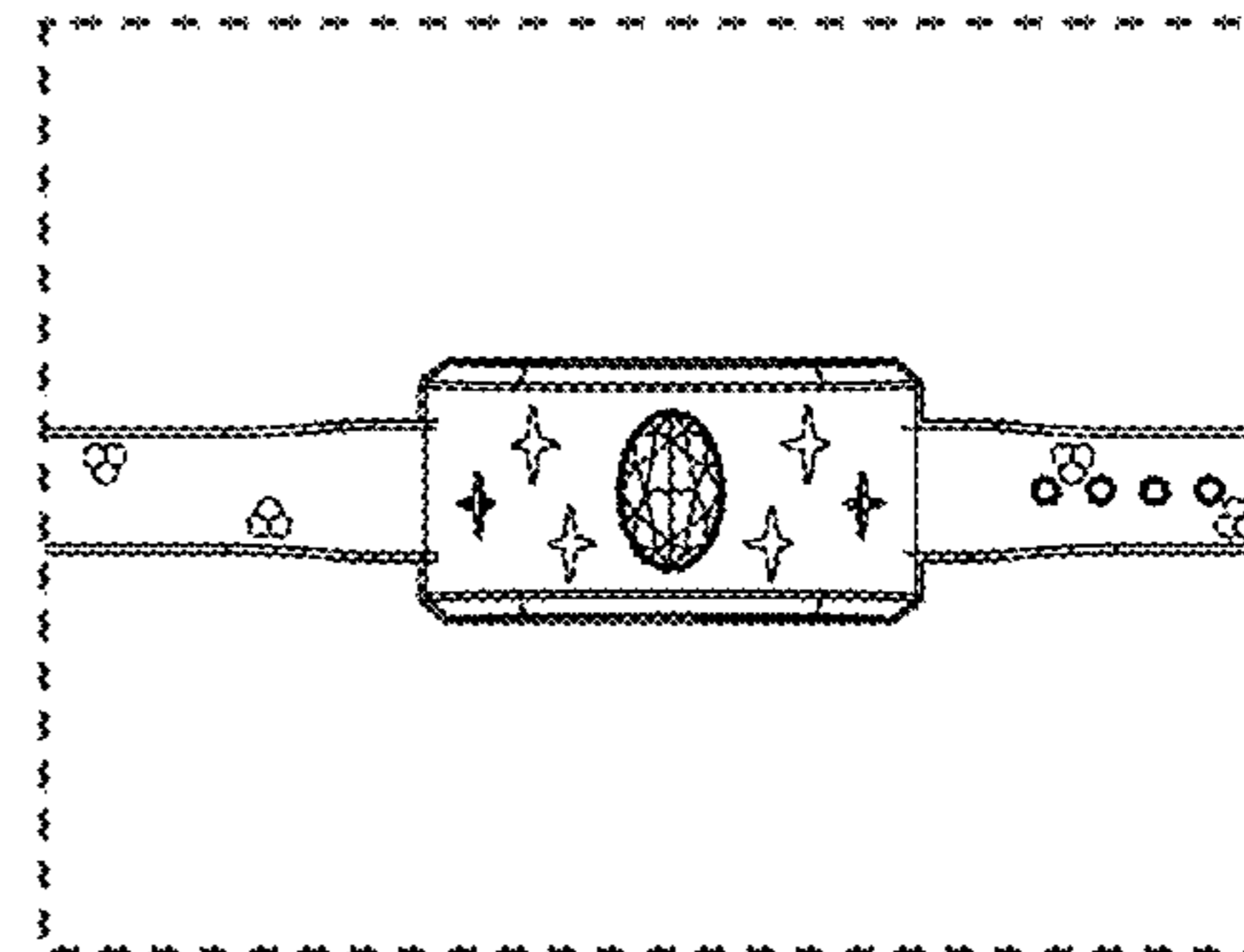
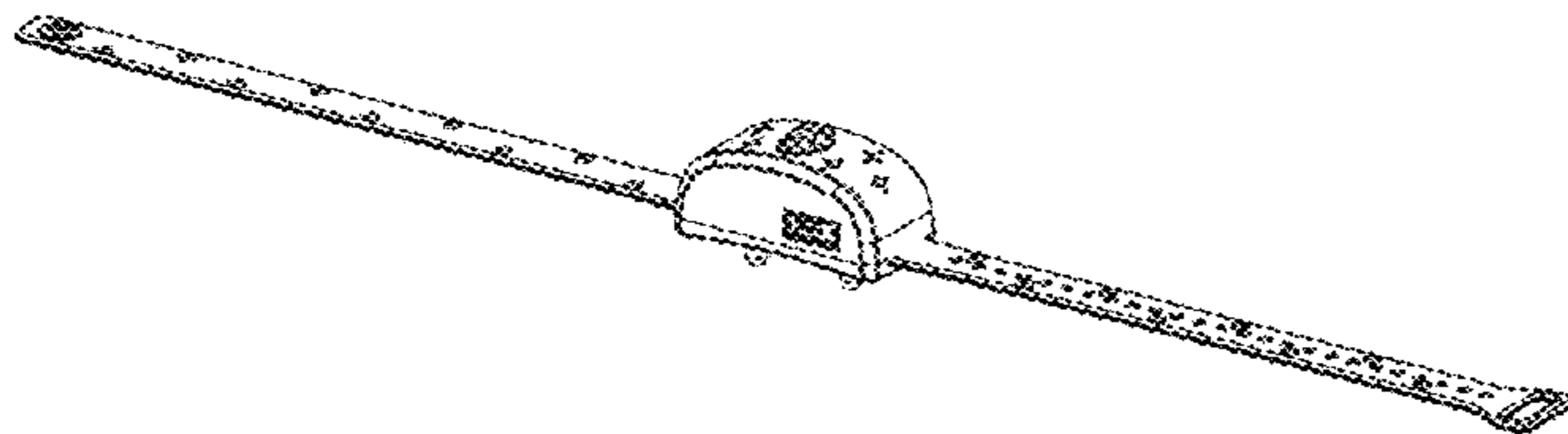

(58) **Field of Classification Search**

USPC ..... 188/83, 82.1, 65.1; 254/134.3 FT;  
 D29/124; D2/627, 624, 633, 625;  
 132/145, 146, 148; 2/314; 59/79.1;  
 340/573.3, 573.1, 573; 343/895;  
 278/8 AES; 231/7; 361/232; D14/344  
 CPC .... A01K 15/021; A01K 15/02; A01K 15/022;  
 A01K 15/023; A01K 15/029; A01K  
 15/04; A01K 15/00; A01K 15/006; A01K  
 27/009; A01K 27/00; A01K 27/001;  
 A01K 27/005-27/008; A01K 29/005;  
 A01K 29/00; A01K 11/006; A01K 11/008  
 See application file for complete search history.

(56) **References Cited**

U.S. PATENT DOCUMENTS

5,434,759 A \* 7/1995 Endo ..... G09F 13/22  
 362/103  
 5,617,814 A \* 4/1997 Bianco ..... A01K 15/023  
 119/720  
 D379,252 S \* 5/1997 McIntosh ..... D30/152  
 5,815,077 A \* 9/1998 Christiansen ..... A01K 15/021  
 119/712  
 D400,458 S \* 11/1998 Titus ..... D10/104.1  
 D410,206 S \* 5/1999 Slater ..... D10/104.1  
 6,079,367 A \* 6/2000 Stapelfeld ..... A01K 15/021  
 119/719  
 D445,352 S \* 7/2001 So ..... D30/199  
 6,474,269 B2 \* 11/2002 So ..... A01K 15/021  
 119/719  
 6,830,012 B1 \* 12/2004 Swan ..... A01K 27/009  
 119/720  
 6,907,844 B1 \* 6/2005 Crist ..... A01K 15/022  
 119/718  
 D520,894 S \* 5/2006 Zakharyan ..... D30/199  
 D522,187 S \* 5/2006 Nottingham ..... D30/152  
 D571,684 S \* 6/2008 Kim ..... D11/2  
 7,382,328 B2 \* 6/2008 Lee, IV ..... A01K 27/009  
 343/718  
 7,559,291 B2 \* 7/2009 Reinhart ..... A01K 15/021  
 119/720  
 7,574,979 B2 \* 8/2009 Nottingham ..... A01K 27/005  
 119/859  
 D636,686 S \* 4/2011 Cobbett ..... D10/38  
 D637,365 S \* 5/2011 Li ..... D30/155  
 D657,098 S \* 4/2012 So ..... D30/152  
 D661,846 S \* 6/2012 Miller ..... D30/152  
 D665,952 S \* 8/2012 Guo ..... D30/152  
 D666,367 S \* 8/2012 Miller ..... D30/152  
 8,296,983 B2 \* 10/2012 Padgett ..... A44C 5/0015  
 40/633  
 D673,334 S \* 12/2012 Guo ..... D30/152  
 D706,159 S \* 6/2014 Ma ..... D11/3  
 8,757,098 B2 \* 6/2014 So ..... A01K 15/021  
 119/719  
 D708,797 S \* 7/2014 MacDonald ..... D30/199  
 D709,047 S \* 7/2014 Jennings ..... D14/167  
 D713,103 S \* 9/2014 Sproviero ..... D30/199  
 D715,675 S \* 10/2014 Ma ..... D11/3  
 8,881,686 B2 \* 11/2014 So ..... A01K 15/021  
 119/712  
 D720,074 S \* 12/2014 Suvilaakso ..... D24/167  
 D720,249 S \* 12/2014 Park ..... D11/3  
 D725,841 S \* 3/2015 So ..... D30/152  
 D735,587 S \* 8/2015 Squires ..... D10/32  
 D761,499 S \* 7/2016 Pulliam ..... D30/199  
 9,449,487 B1 \* 9/2016 Spitalny ..... A01K 15/023  
 D772,745 S \* 11/2016 Henne ..... D10/70  
 D794,261 S \* 8/2017 Pulliam ..... D30/152  
 D798,003 S \* 9/2017 Dong ..... D30/199  
 D819,280 S \* 5/2018 Li ..... D30/199  
 D822,516 S \* 7/2018 Van Curen ..... D10/104.1  
 D822,921 S \* 7/2018 Wen ..... D30/199

D822,922 S \* 7/2018 Wen ..... D30/199  
 D829,120 S \* 9/2018 Mitchell ..... D10/104.1  
 D834,769 S \* 11/2018 Wen ..... D30/199  
 2002/0050250 A1 \* 5/2002 Peterson ..... A01K 15/023  
 119/721  
 2003/0122678 A1 \* 7/2003 Duncan ..... A01K 15/021  
 340/573.3  
 2004/0162875 A1 \* 8/2004 Brown ..... G08B 5/223  
 709/203  
 2005/0145196 A1 \* 7/2005 Crist ..... A01K 15/022  
 119/718  
 2005/0145197 A1 \* 7/2005 Crist ..... A01K 15/022  
 119/718  
 2005/0145198 A1 \* 7/2005 Crist ..... A01K 15/022  
 119/718  
 2005/0145199 A1 \* 7/2005 Napolez ..... A01K 15/022  
 119/718  
 2005/0145200 A1 \* 7/2005 Napolez ..... A01K 15/022  
 119/718  
 2005/0211187 A1 \* 9/2005 Harman ..... A01K 15/023  
 119/721  
 2005/0277855 A1 \* 12/2005 Tanaka ..... A01K 15/022  
 601/46  
 2006/0169222 A1 \* 8/2006 Gerig ..... A01K 15/021  
 119/859  
 2006/0207520 A1 \* 9/2006 Moore ..... A01K 15/021  
 119/720  
 2007/0209604 A1 \* 9/2007 Groh ..... A01K 15/021  
 119/858  
 2007/0221138 A1 \* 9/2007 Mainini ..... A01K 15/021  
 119/720  
 2007/0227465 A1 \* 10/2007 Gerig ..... A01K 15/021  
 119/859  
 2008/0061990 A1 \* 3/2008 Milnes ..... A01K 15/023  
 340/573.1  
 2009/0289844 A1 \* 11/2009 Palsgrove ..... A01K 15/021  
 342/357.55  
 2010/0050954 A1 \* 3/2010 Lee, IV ..... A01K 15/022  
 119/718  
 2011/0232585 A1 \* 9/2011 Rich ..... A01K 15/023  
 119/721  
 2012/0160183 A1 \* 6/2012 So ..... A01K 15/021  
 119/720  
 2013/0027207 A1 \* 1/2013 Goetzl ..... A01K 11/008  
 340/573.3  
 2013/0112153 A1 \* 5/2013 So ..... A01K 15/021  
 119/720  
 2013/0180467 A1 \* 7/2013 Wong ..... A01K 15/022  
 119/718  
 2013/0233252 A1 \* 9/2013 Bellon ..... A01K 15/021  
 119/720  
 2014/0116356 A1 \* 5/2014 Balenzano ..... A01K 27/006  
 119/858  
 2014/0123912 A1 \* 5/2014 Menkes ..... A61B 5/1105  
 119/859  
 2014/0196673 A1 \* 7/2014 Menkes ..... A01K 27/009  
 119/859  
 2014/0261233 A1 \* 9/2014 So ..... A01K 27/009  
 119/720  
 2014/0331942 A1 \* 11/2014 Sarazyn ..... A01K 29/005  
 119/719  
 2015/0033794 A1 \* 2/2015 Ma ..... A44C 15/0015  
 63/1.13  
 2015/0040839 A1 \* 2/2015 Goetzl ..... A01K 15/023  
 119/720  
 2015/0250143 A1 \* 9/2015 Klossner ..... A01K 27/009  
 119/719  
 2017/0196201 A1 \* 7/2017 Kenney ..... A01K 27/006  
 2017/0265432 A1 \* 9/2017 Anderton ..... G01S 5/02  
 2018/0125038 A1 \* 5/2018 Hord ..... A01K 27/009  
 2018/0132450 A1 \* 5/2018 Goetzl ..... A01K 27/009  
 2018/0153137 A1 \* 6/2018 Goetzl ..... A01K 15/022  
 2018/0153138 A1 \* 6/2018 Goetzl ..... A01K 15/022  
 2018/0184618 A1 \* 7/2018 Gotts ..... A01K 15/023

\* cited by examiner

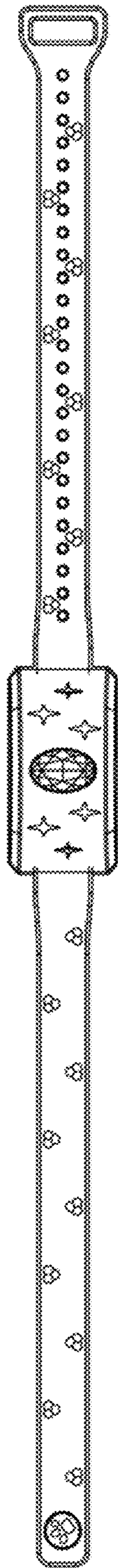

FIG. 1

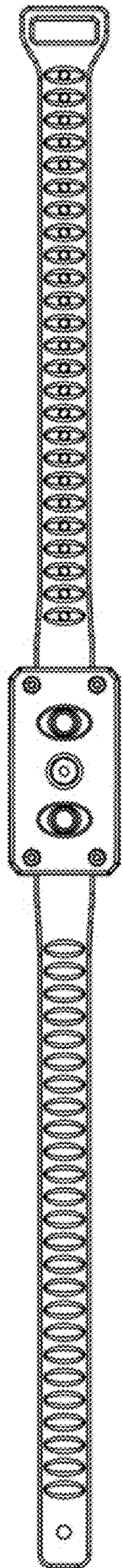

FIG. 2

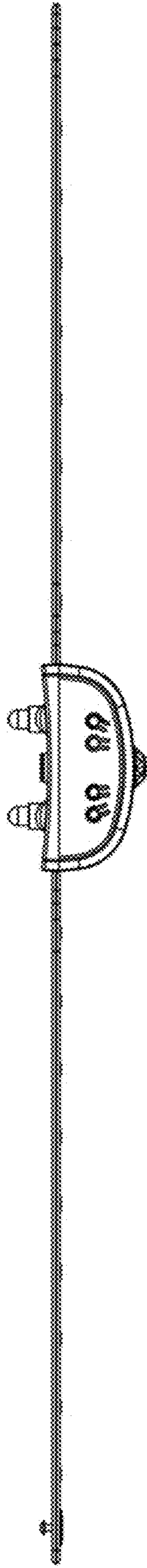

FIG. 3

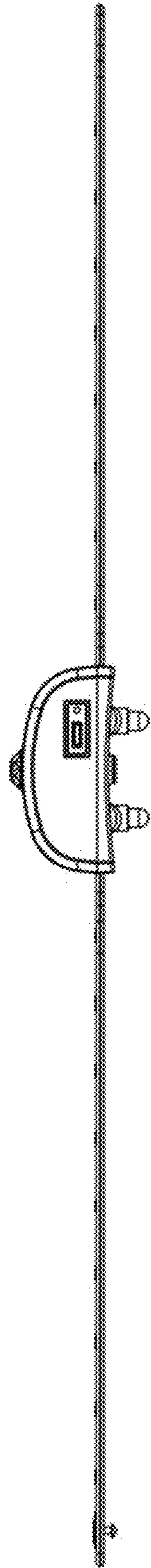

FIG. 4

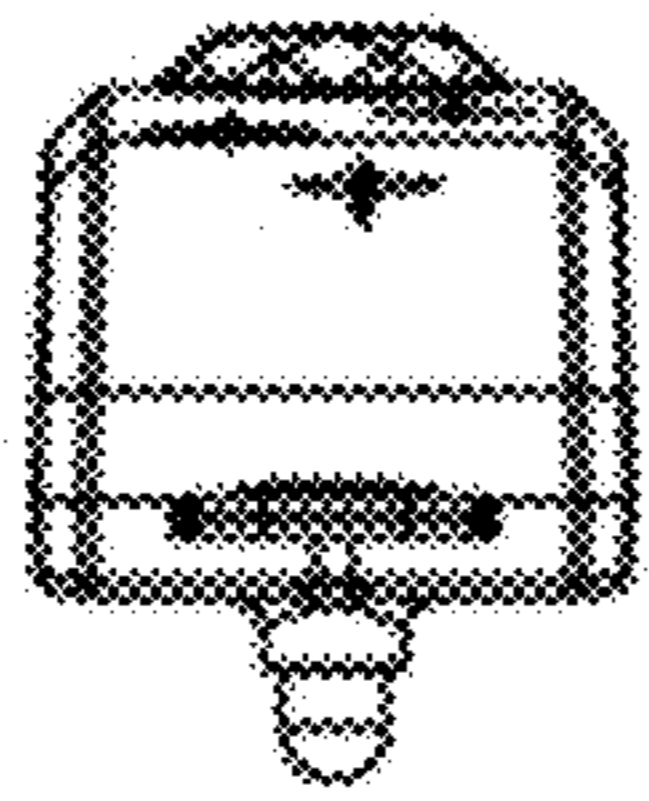

FIG. 5

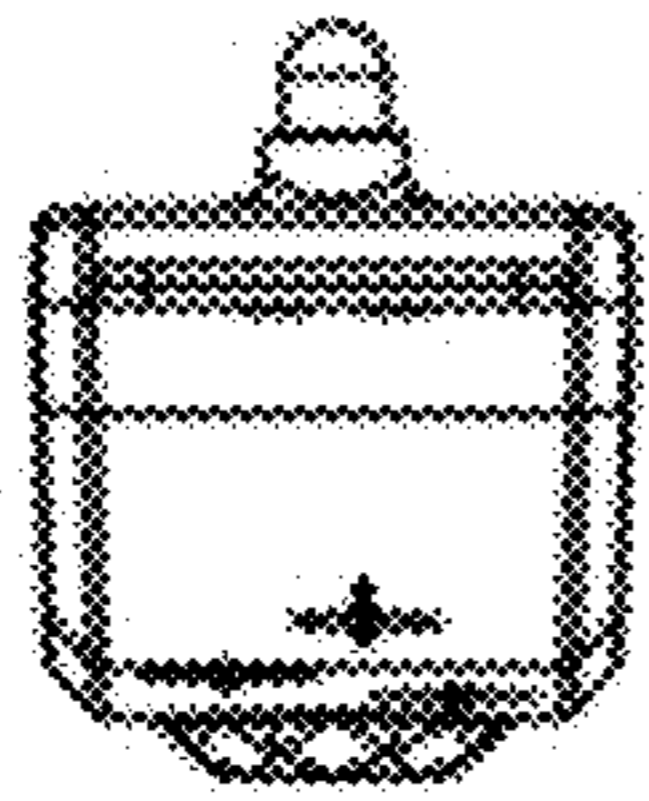

FIG. 6



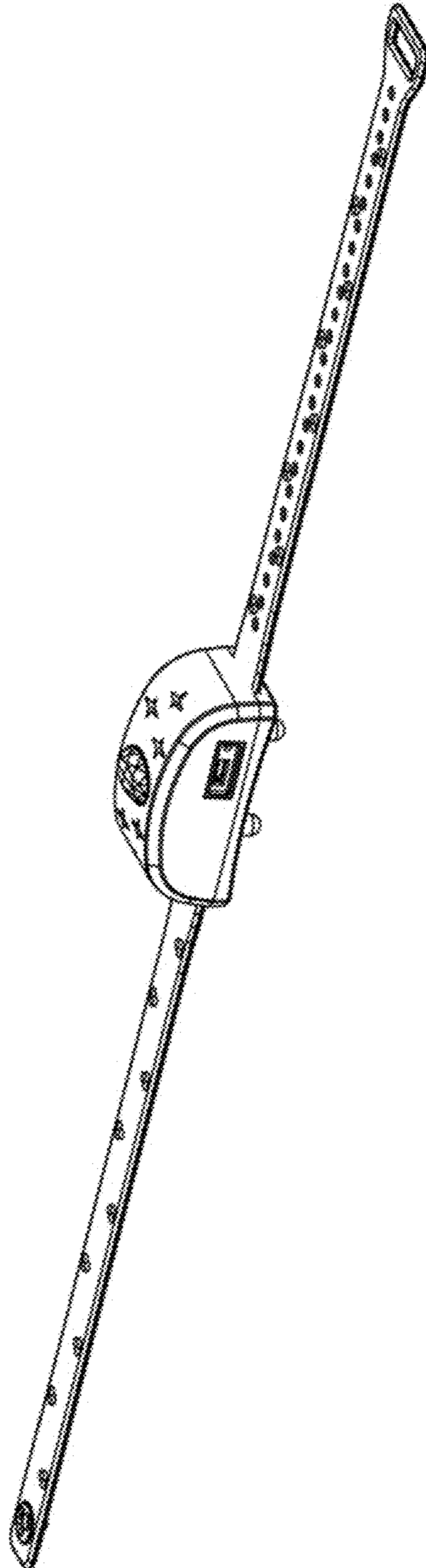

FIG. 7

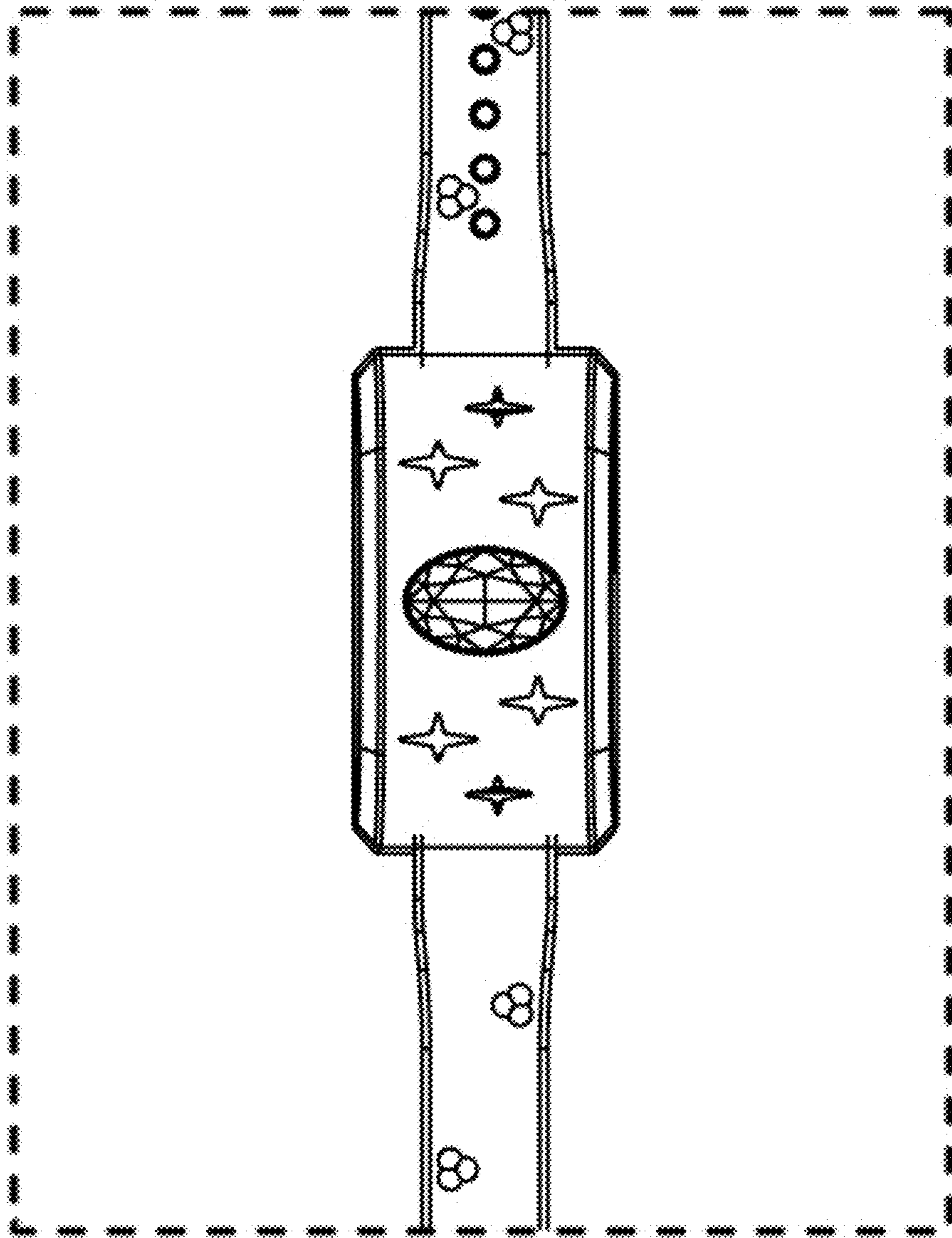

FIG. 8

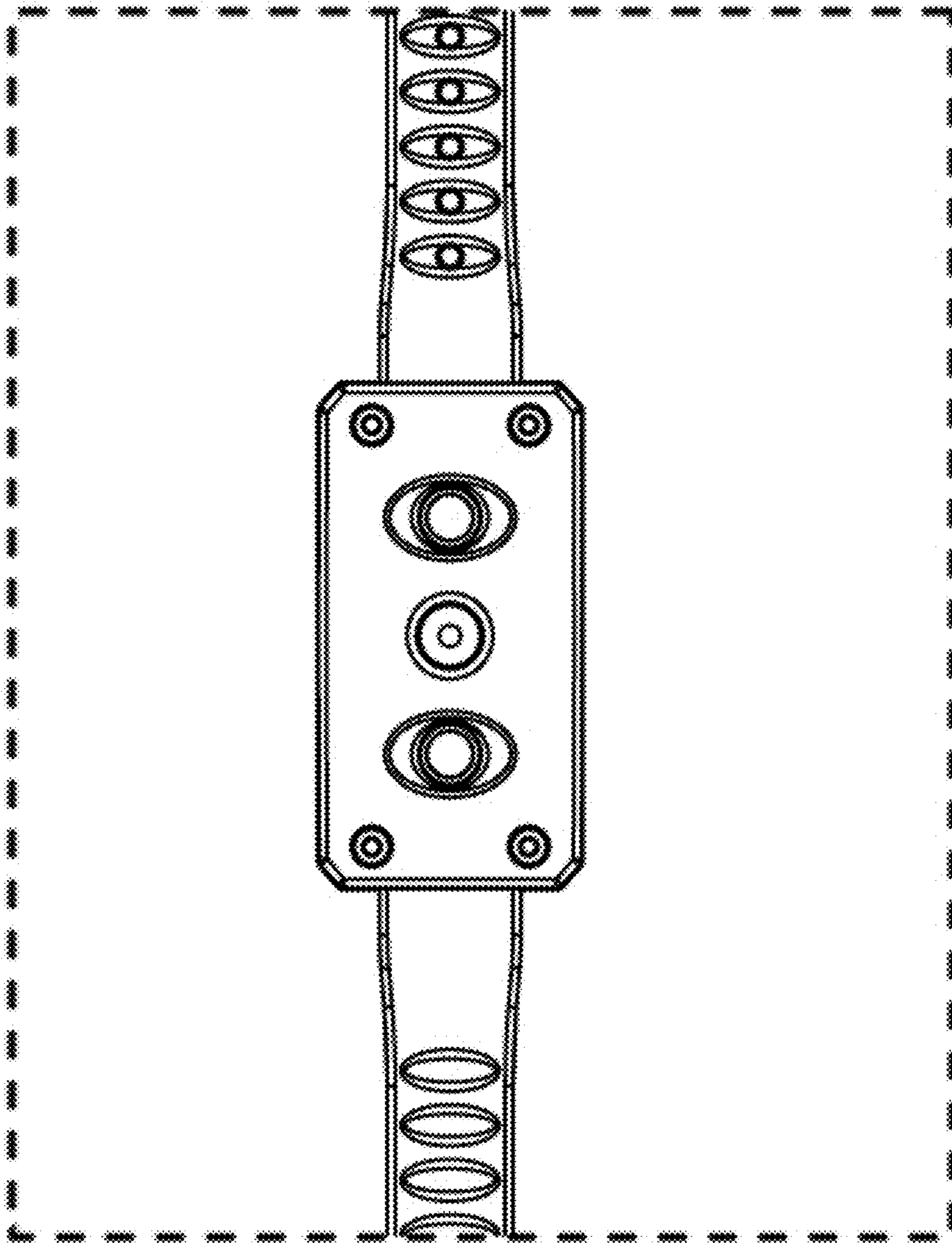

FIG. 9

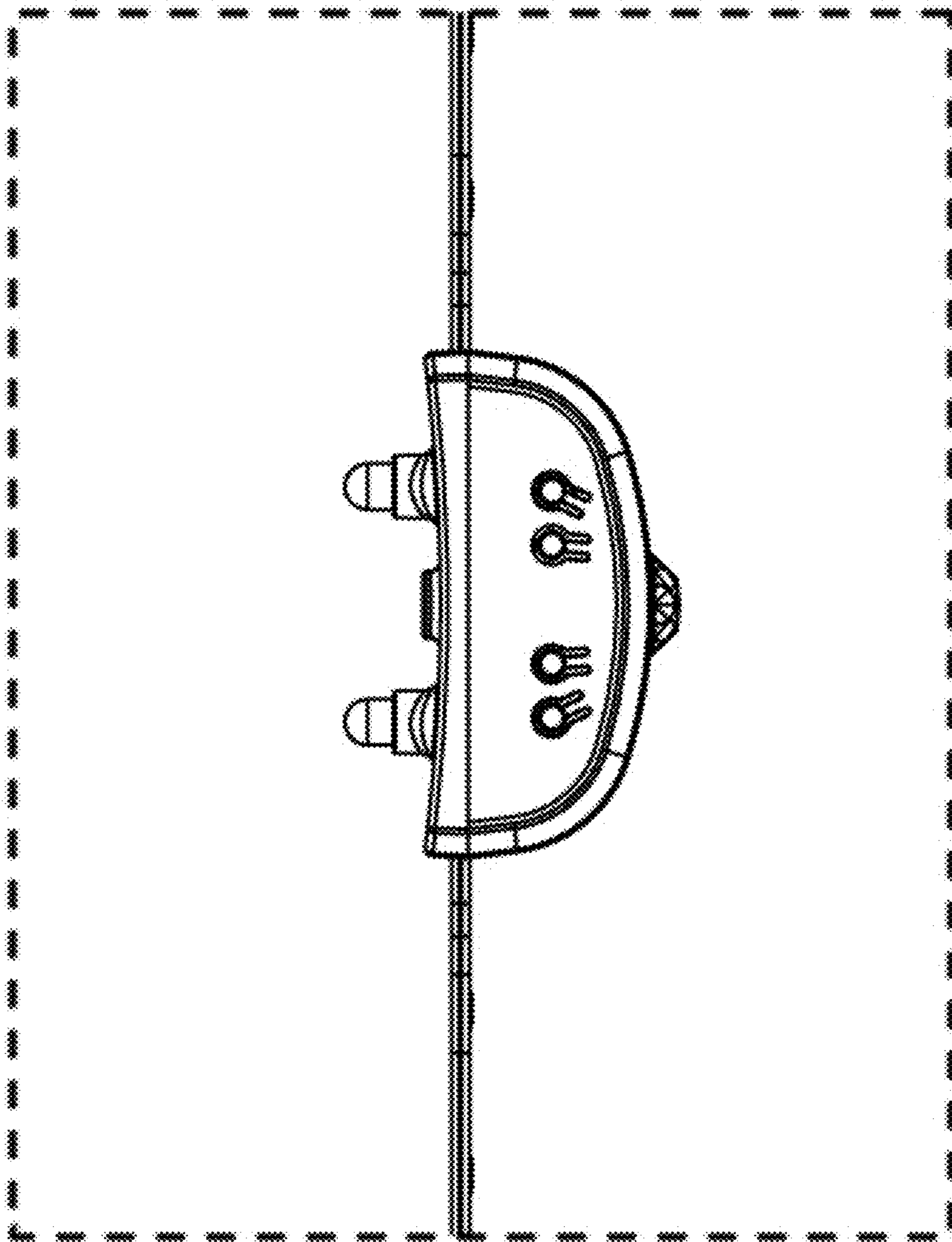

FIG. 10

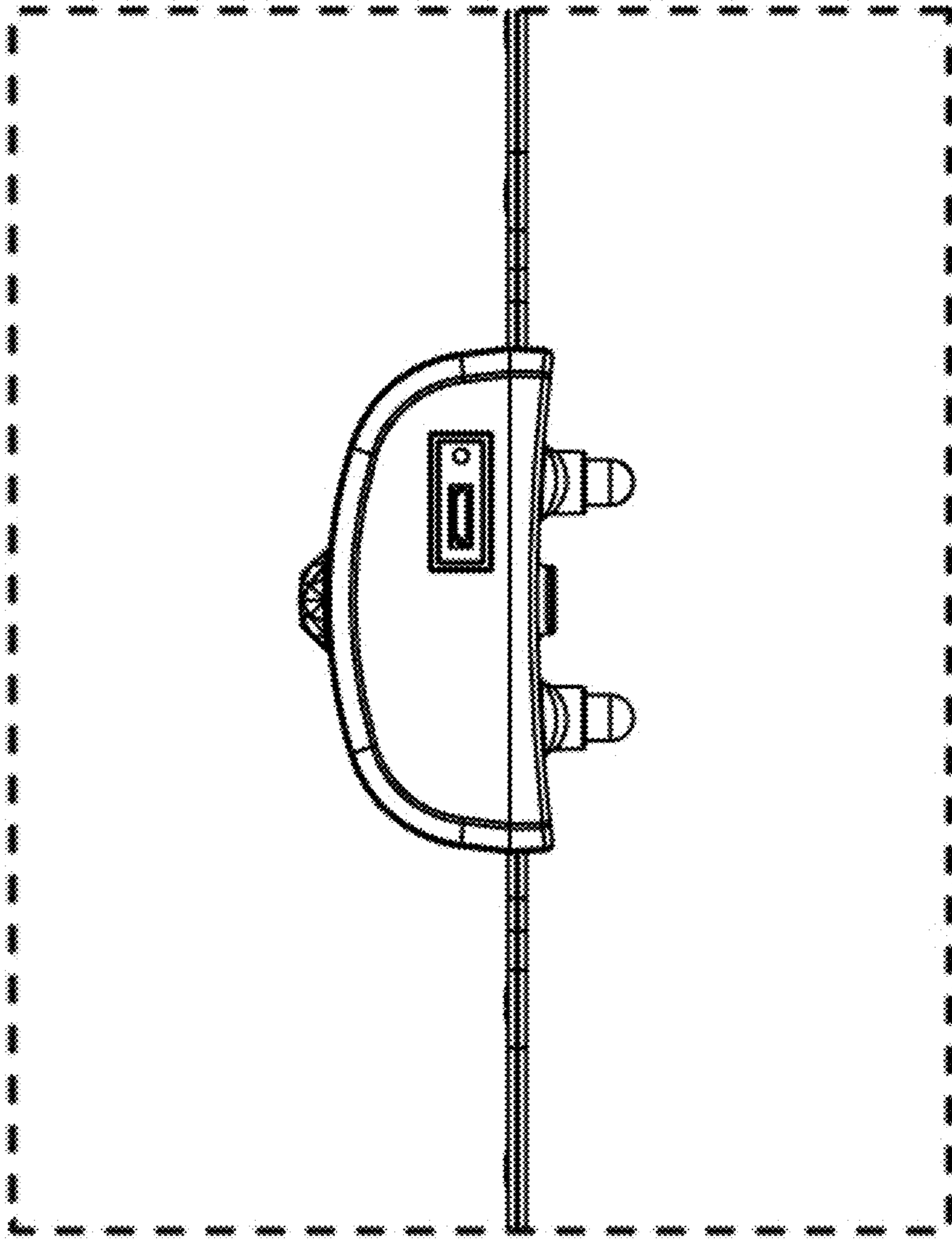

FIG. 11

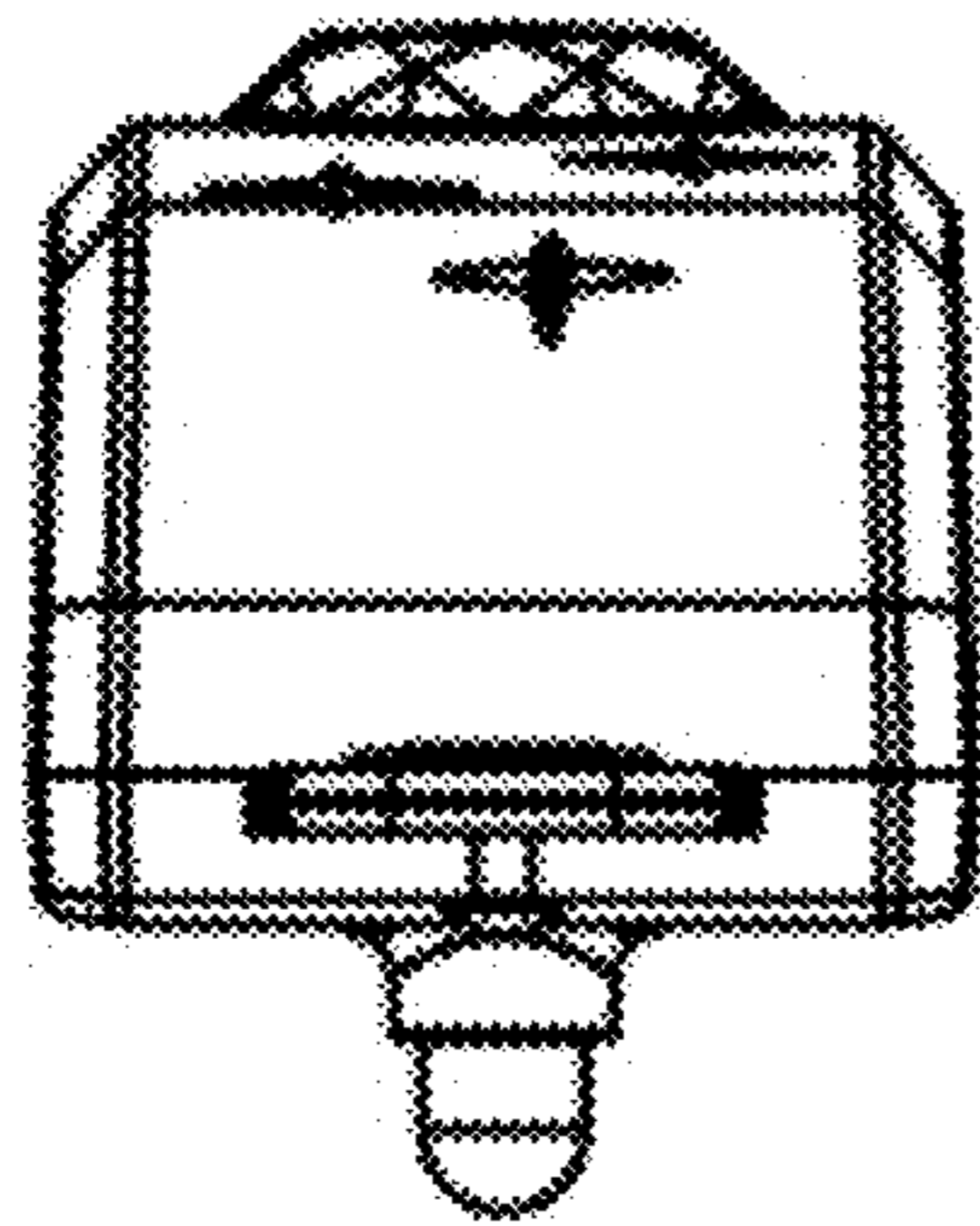

FIG. 12

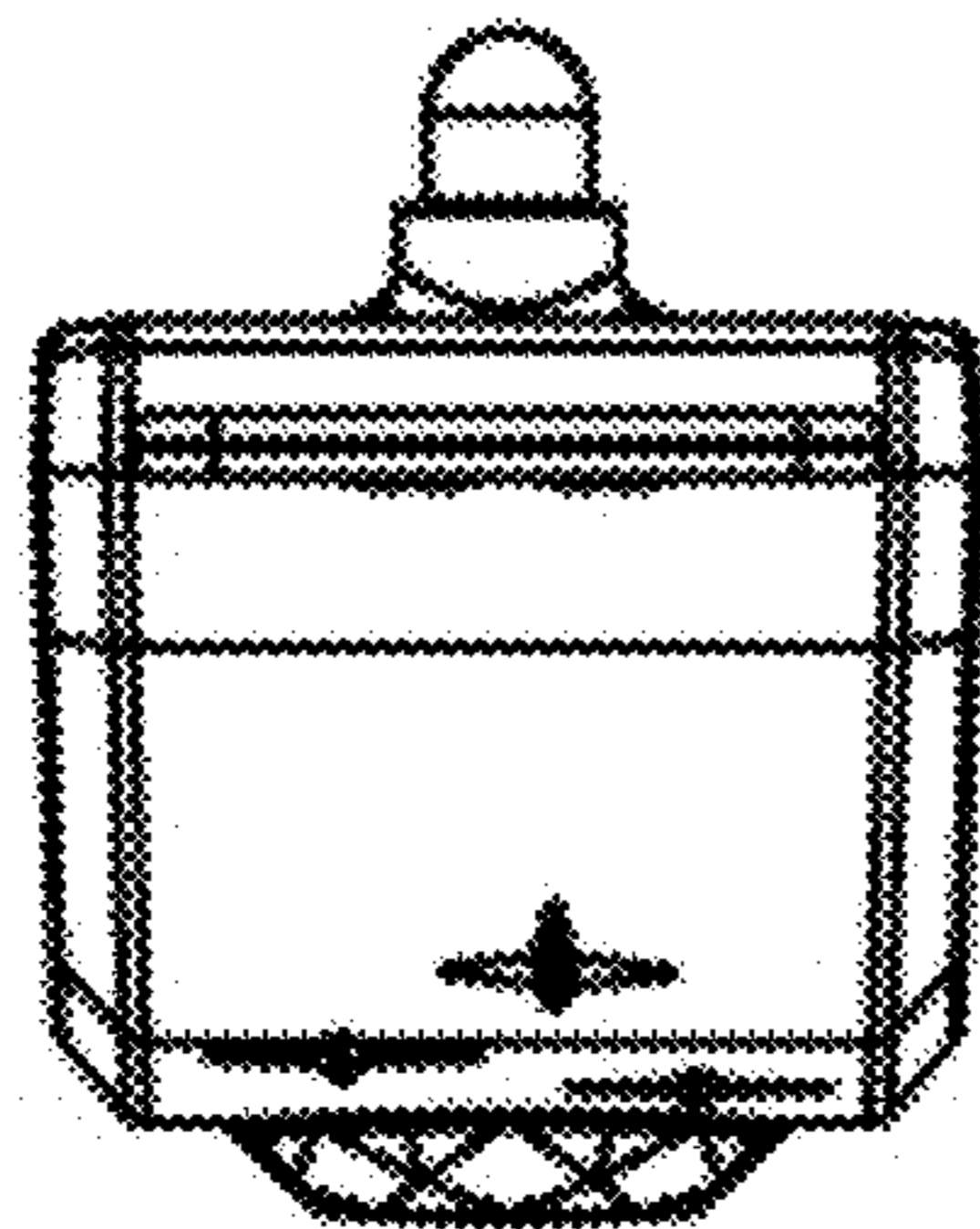

FIG. 13