



US00D850711S

(12) **United States Design Patent**
He et al.

(10) **Patent No.:** **US D850,711 S**

(45) **Date of Patent:** **** Jun. 4, 2019**

(54) **DISPENSER FOR E-LIQUID**

(71) Applicants: **David Quan He**, Johns Creek, GA
(US); **Chin Guan Kee**, Kuala Kurau
(MY)

(72) Inventors: **David Quan He**, Johns Creek, GA
(US); **Chin Guan Kee**, Kuala Kurau
(MY)

(**) Term: **15 Years**

(21) Appl. No.: **29/567,547**

(22) Filed: **Jun. 9, 2016**

(51) **LOC (11) Cl.** **27-02**

(52) **U.S. Cl.**
USPC **D27/162**

(58) **Field of Classification Search**
USPC D27/100, 101, 162-170, 172-195;
D1/100-130, 199; 426/104, 115, 121,
426/129, 130, 144, 249, 274, 303, 414,
426/420; D6/597; D7/507, 675, 300.1,
D7/523, 524, 565, 700; 220/574; 29/428
CPC A24F 1/30; A24F 47/002; A24F 9/14
See application file for complete search history.

(56) **References Cited**

U.S. PATENT DOCUMENTS

D265,469 S * 7/1982 Hegnes D11/67
D389,635 S * 1/1998 Henderson D1/127
D427,746 S * 7/2000 Cox D1/102

D463,064 S * 9/2002 Hong D27/157
D486,638 S * 2/2004 Menceles D3/201
D498,684 S * 11/2004 Friedman D10/50
D521,724 S * 5/2006 Gotlieb D3/211
D566,587 S * 4/2008 Rosen D10/50
D586,526 S * 2/2009 Trazza D1/102
D665,280 S * 8/2012 Petrillo D10/50
8,406,449 B2 * 3/2013 Wegener H04R 1/02
381/386
9,745,107 B2 * 8/2017 Zahr B65D 50/046
D812,290 S * 3/2018 Ward D27/172

* cited by examiner

Primary Examiner — Katie Jaen Stofko
(74) *Attorney, Agent, or Firm* — Ming Jiang; MM IP
Services LLC

(57) **CLAIM**

I claim the ornamental design for a dispenser for e-liquid, as shown and described.

DESCRIPTION

FIG. 1 is a right side, top perspective view of a dispenser for e-liquid embodying our new design; FIG. 2 is a front plan view thereof; FIG. 3 is a back plan view thereof; FIG. 4 is a left side view thereof; FIG. 5 is a right side view thereof; FIG. 6 is a top side view thereof; and, FIG. 7 is a bottom side view thereof. The broken lines in the drawings illustrate portions of the dispenser for e-liquid that form no part of the claimed design.

1 Claim, 5 Drawing Sheets

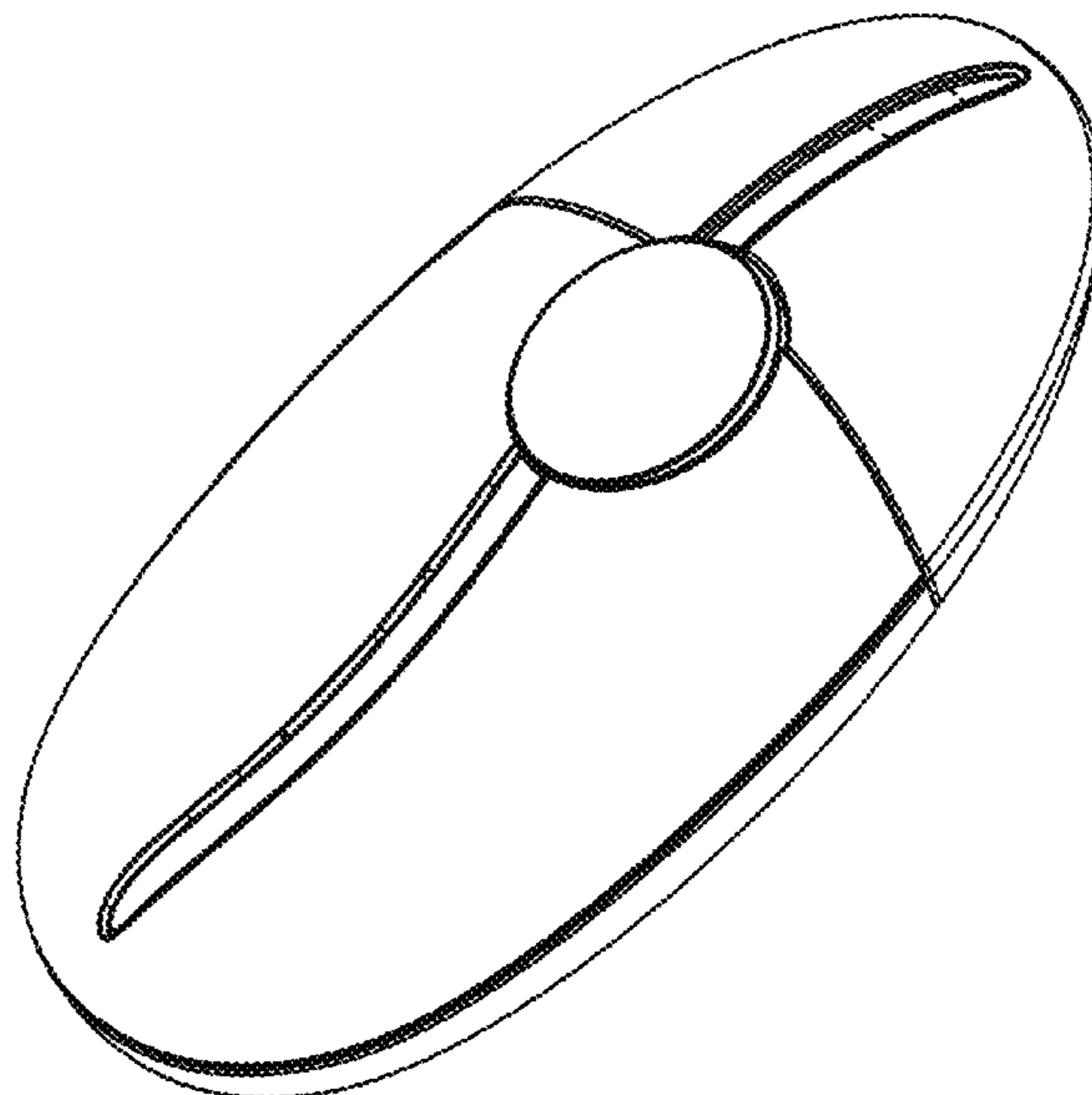

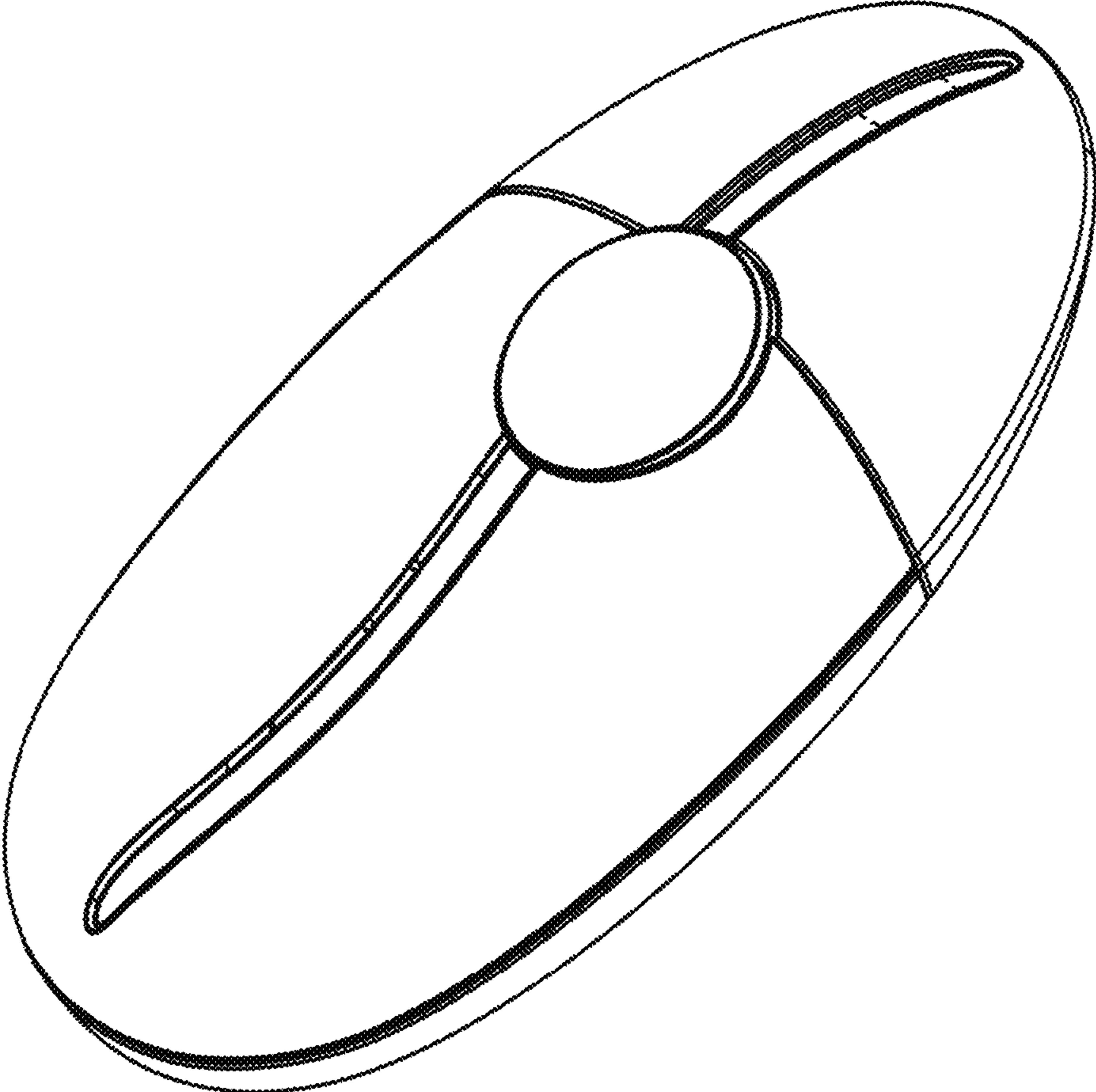

FIG. 1

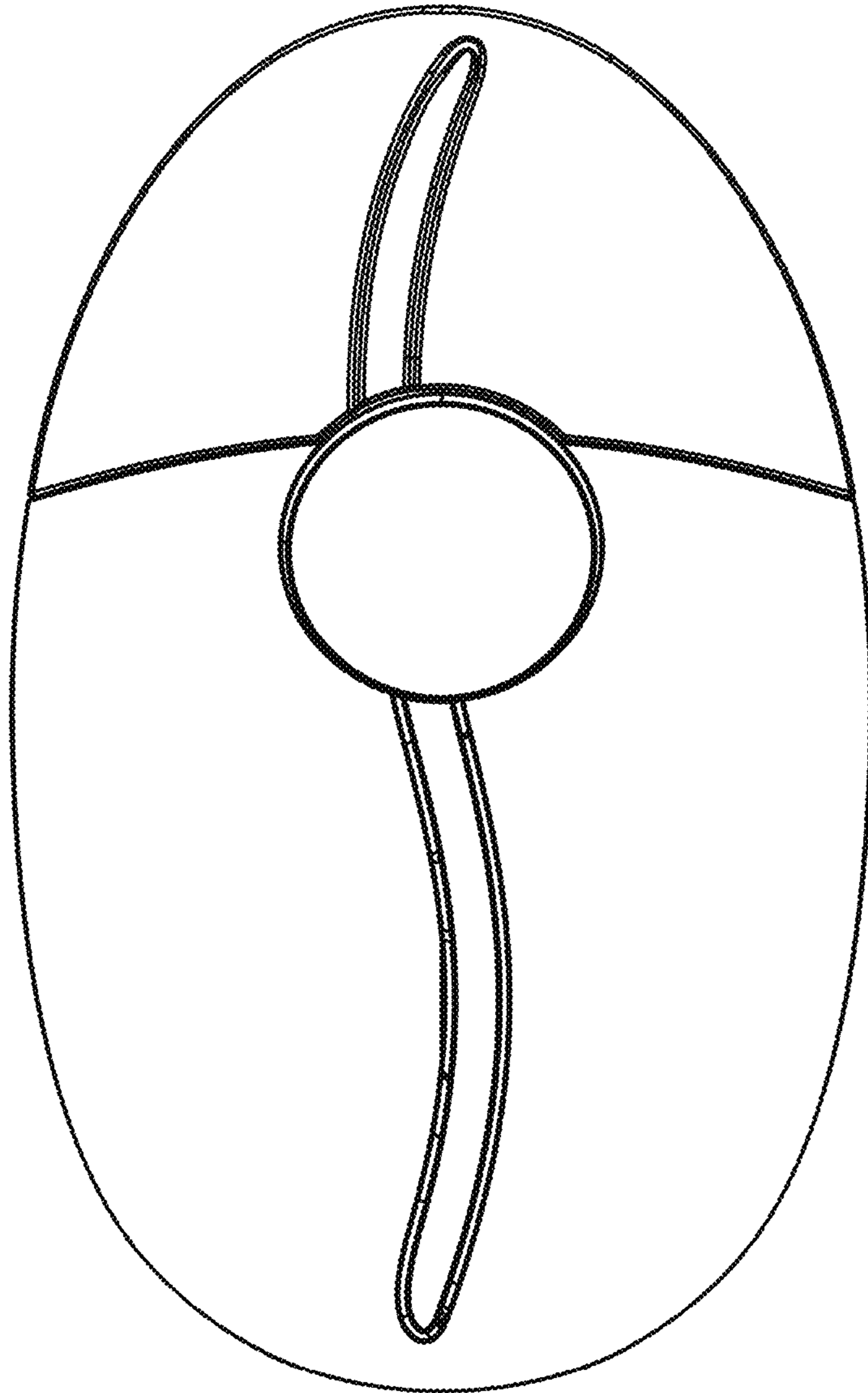

FIG. 2

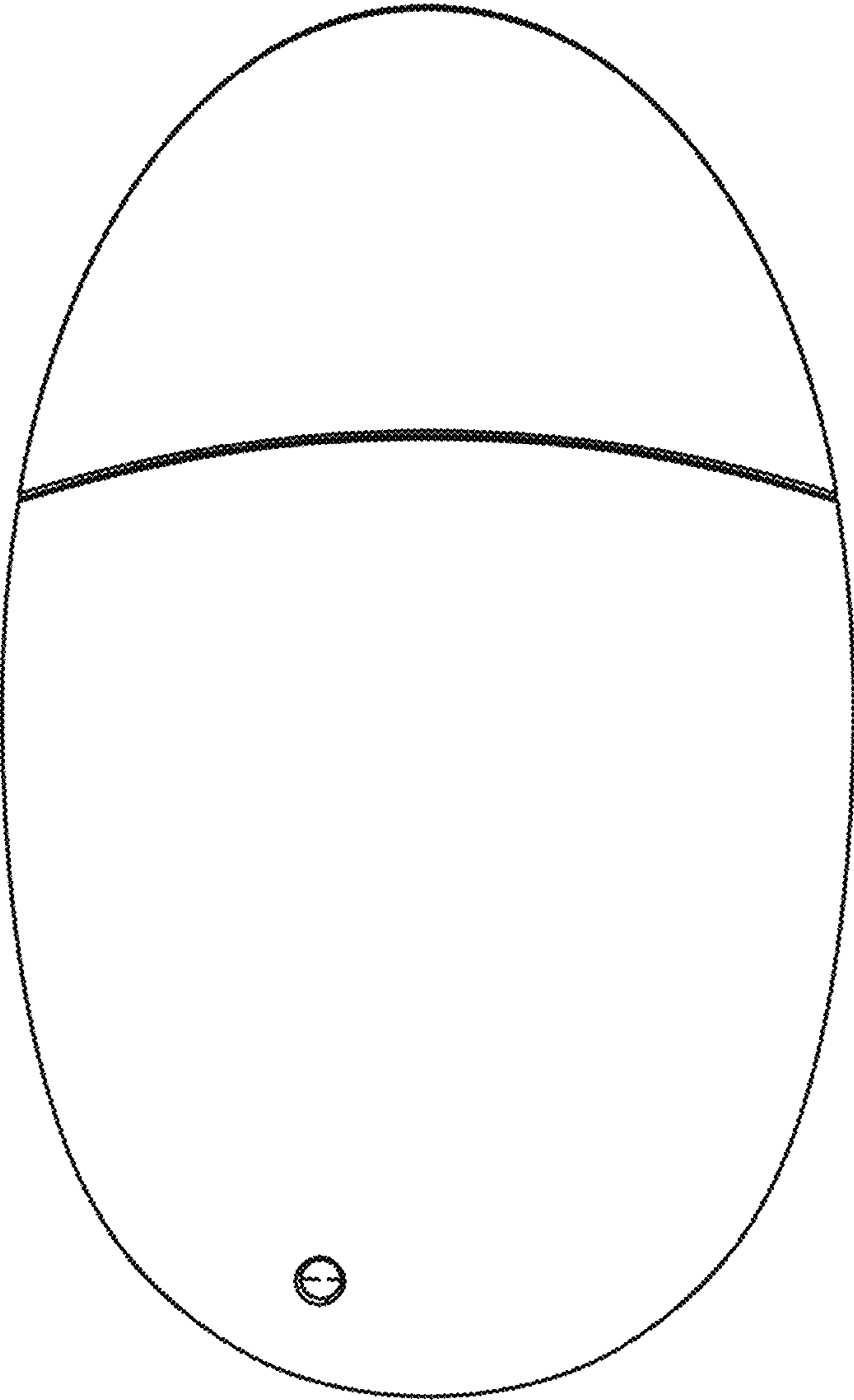

FIG. 3

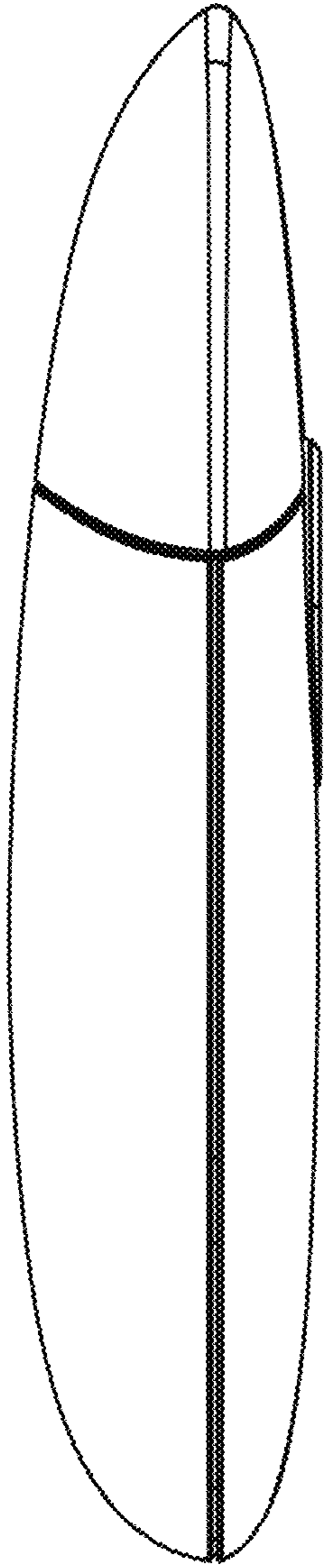

FIG. 4

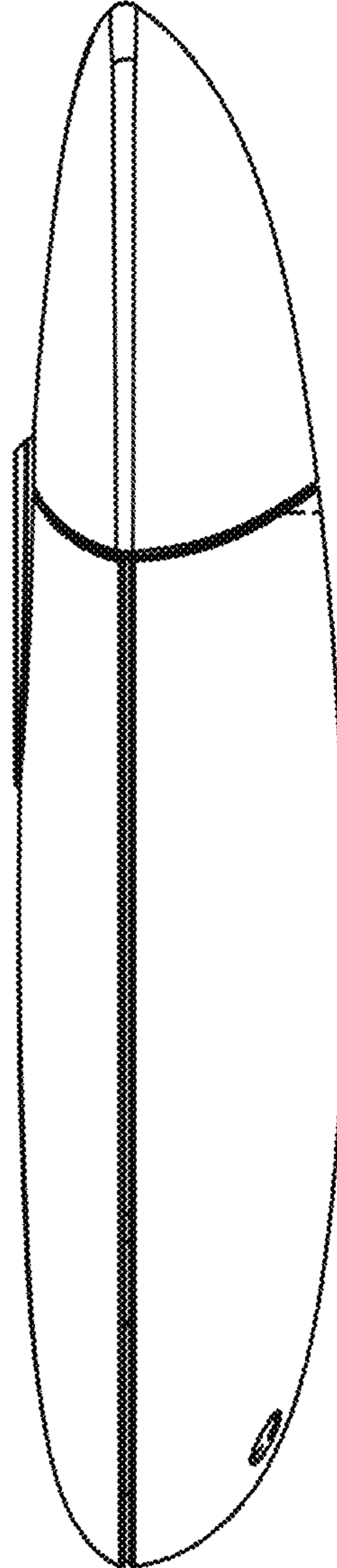

FIG. 5

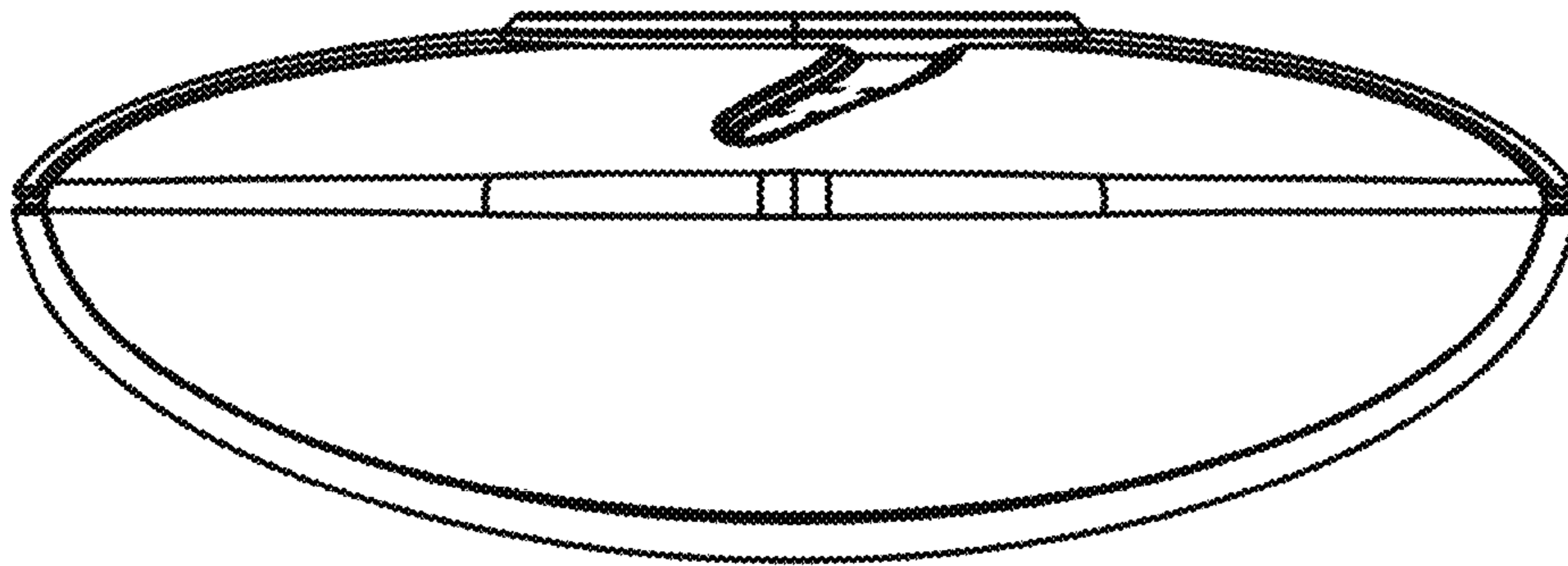

FIG. 6

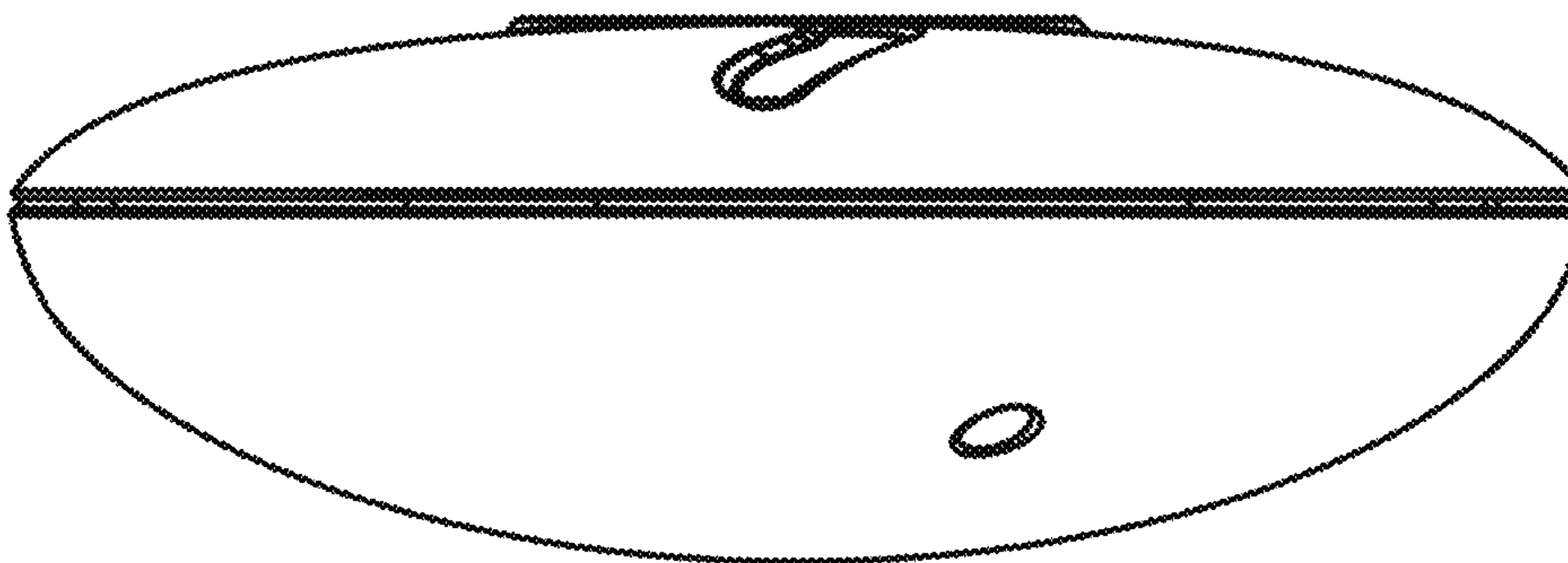

FIG. 7