



US00D850654S

(12) **United States Design Patent**  
**Ji**

(10) **Patent No.:** **US D850,654 S**

(45) **Date of Patent:** **\*\* Jun. 4, 2019**

(54) **PAVILION**

(71) Applicant: **FreeStyle International Co. Ltd.**,  
Ningbo (CN)

(72) Inventor: **Jin Ji**, Ningbo (CN)

(73) Assignee: **FreeStyle Outdoor Living Co., Ltd.**,  
Ningbo, Zhejiang Province (CN)

(\*\*) Term: **15 Years**

(21) Appl. No.: **29/618,777**

(22) Filed: **Sep. 24, 2017**

(51) **LOC (11) Cl.** ..... **25-03**

(52) **U.S. Cl.**  
USPC ..... **D25/56; D25/26**

(58) **Field of Classification Search**  
USPC ..... D25/1, 4, 15, 16, 18, 23, 26, 32, 33;  
D21/834, 837, 838; 52/79.1  
CPC ..... E04H 1/1205; E04H 1/02; E04H 1/12;  
E04H 9/14; E04H 9/16; E04H 15/001;  
E04H 15/008; E04H 15/38; E04H  
2001/1283; E04H 9/12; A01G 9/14  
See application file for complete search history.

(56) **References Cited**

**U.S. PATENT DOCUMENTS**

- 2,120,861 A \* 6/1938 Hastings ..... E04H 15/34  
D25/33
- D329,705 S \* 9/1992 Forsyth ..... D25/16
- 6,758,014 B2 \* 7/2004 Chen ..... A01G 9/14  
52/63
- D501,259 S \* 1/2005 Wang ..... D25/1

- D506,836 S \* 6/2005 Wang ..... D25/1
- D559,997 S \* 1/2008 Sugimori ..... D25/33
- D640,798 S \* 6/2011 Rassat ..... D25/15
- D812,247 S \* 3/2018 Price ..... D25/16
- 2005/0022854 A1 \* 2/2005 Wu ..... E04H 1/12  
135/156

\* cited by examiner

*Primary Examiner* — Brett Miller

(74) *Attorney, Agent, or Firm* — Themis Law

(57) **CLAIM**

The ornamental design for a pavilion, as shown and described.

**DESCRIPTION**

FIG. 1 is a perspective view of a pavilion showing my new design;  
 FIG. 2 is a front elevational view thereof, the right side, left side, and rear side views being the same;  
 FIG. 3 is a top plan view thereof;  
 FIG. 4 is a perspective view thereof, shown with the doors open;  
 FIG. 5 is a front elevational view thereof, shown with the doors open, the right side, left side, and rear side views being the same; and,  
 FIG. 6 is a detail view of the handle portion of the pavilion of FIG. 1.  
 The broken lines are included for the purpose of illustrating unclaimed portions of the pavilion and form no part of the claimed design.

**1 Claim, 6 Drawing Sheets**

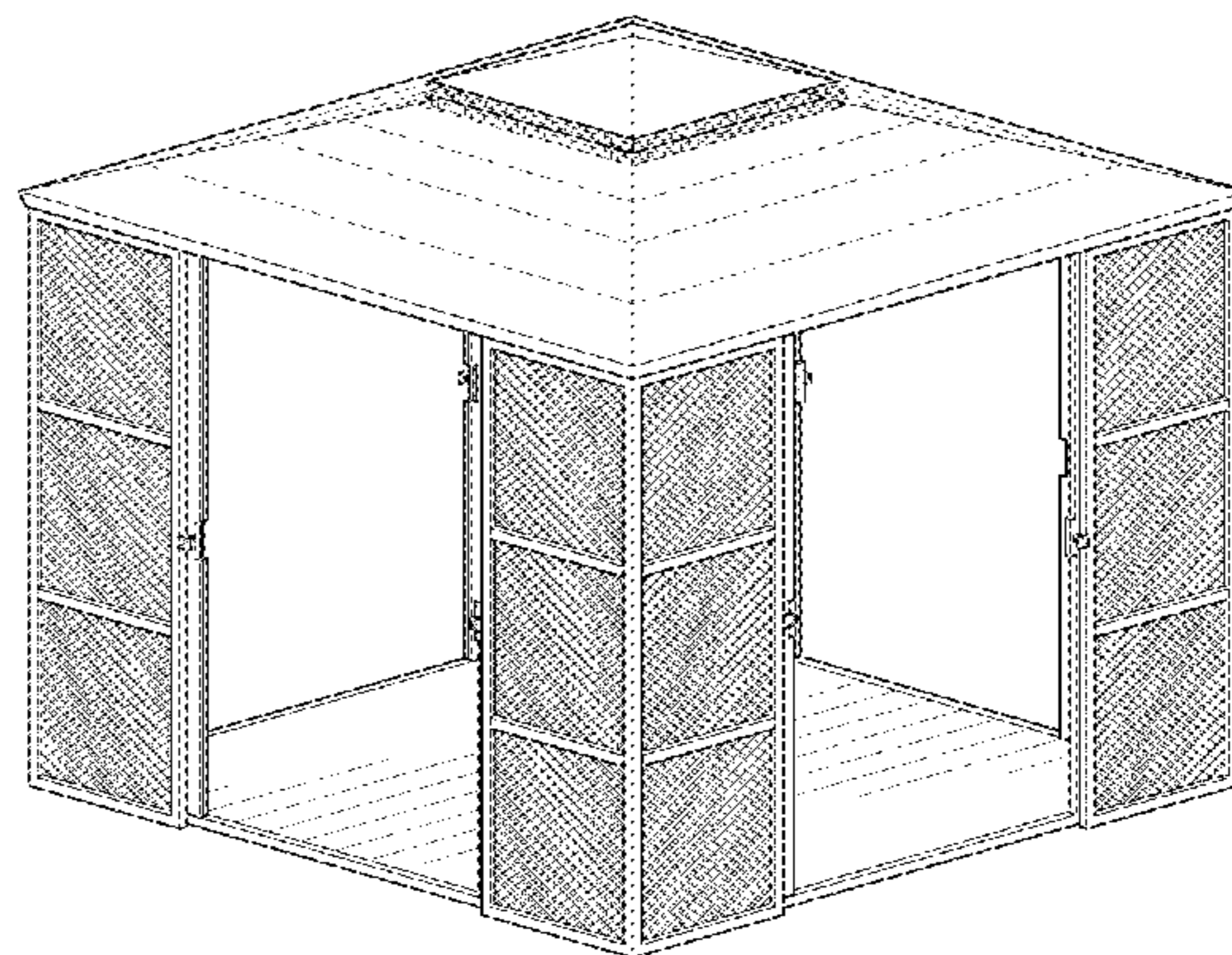
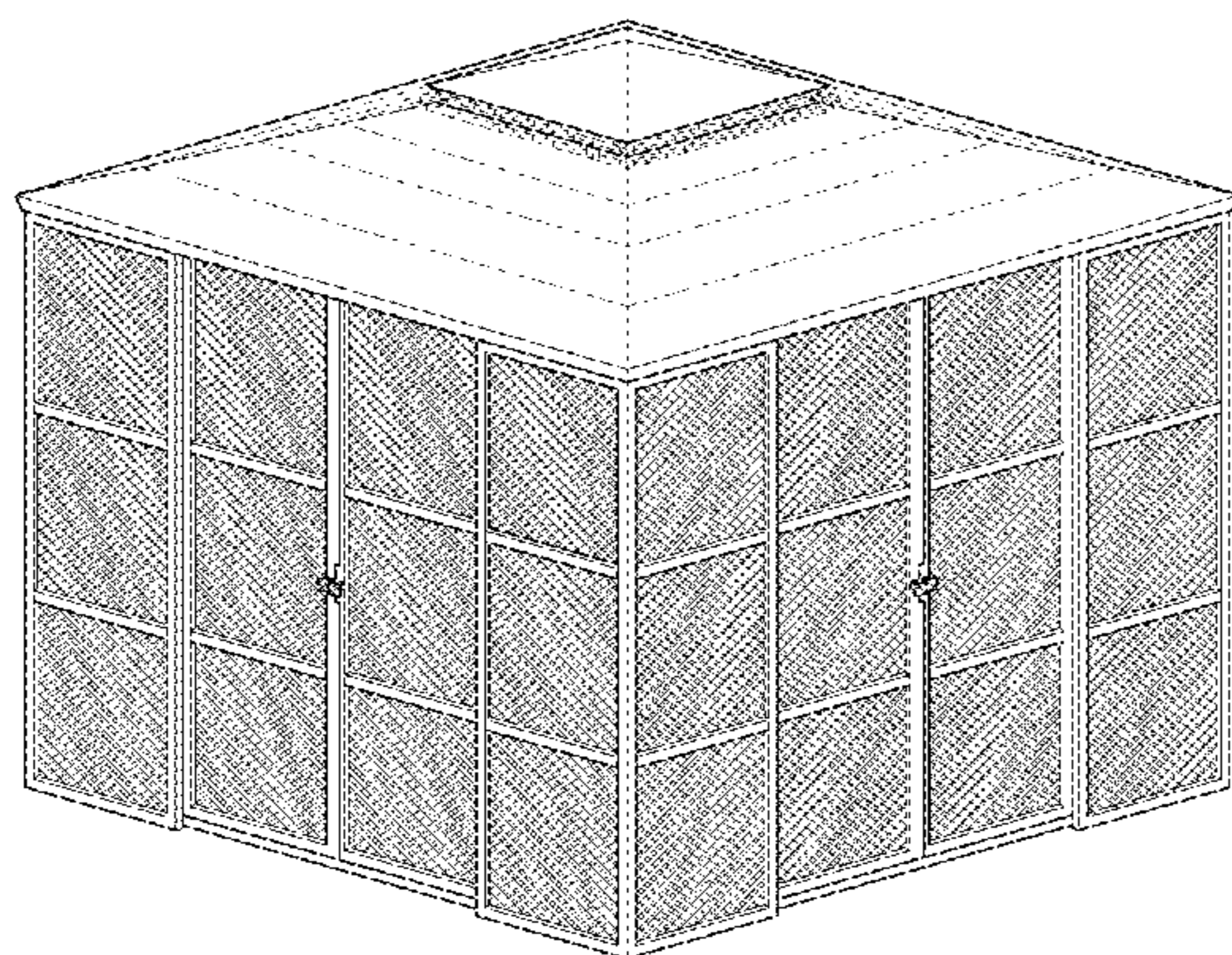

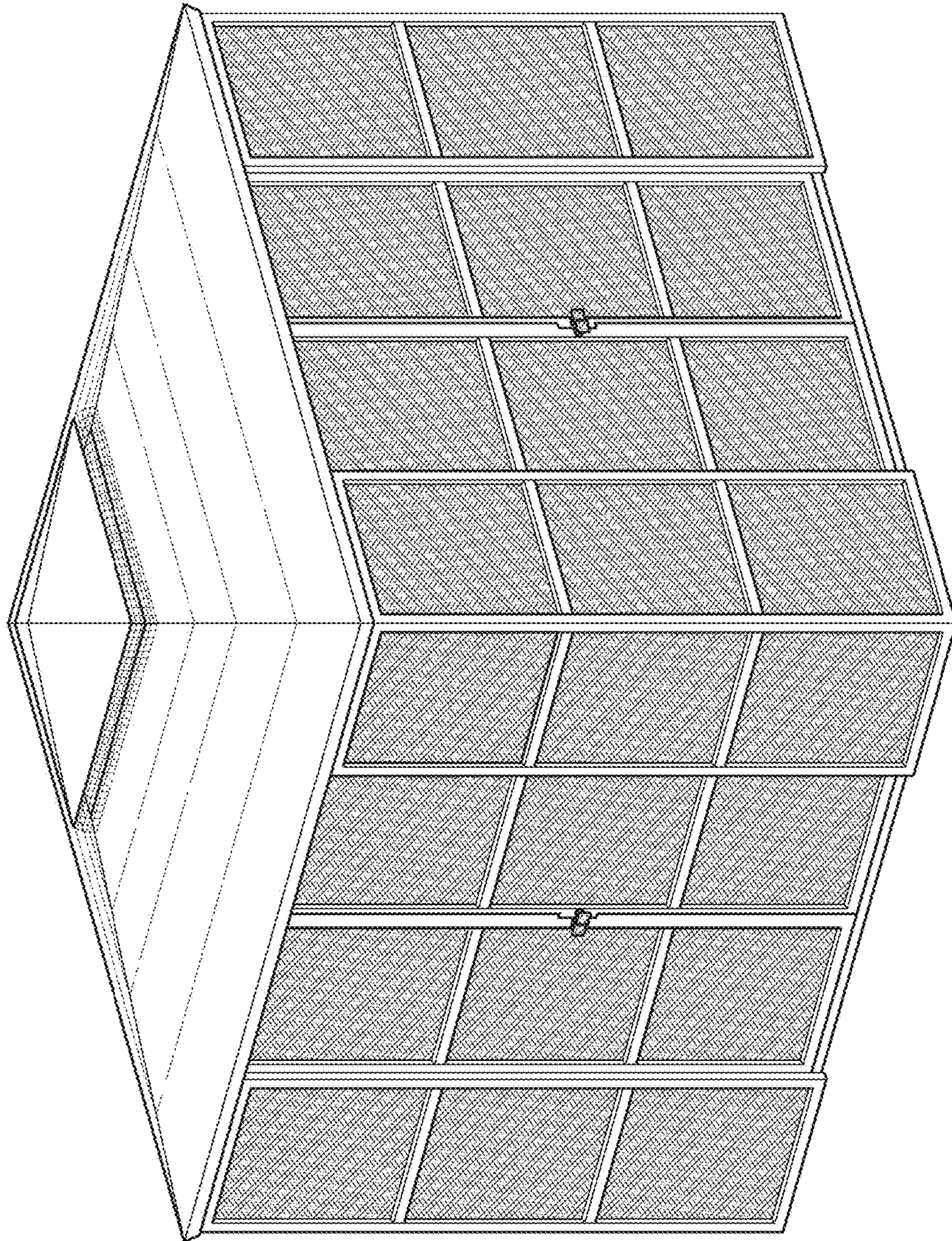

FIG. 1

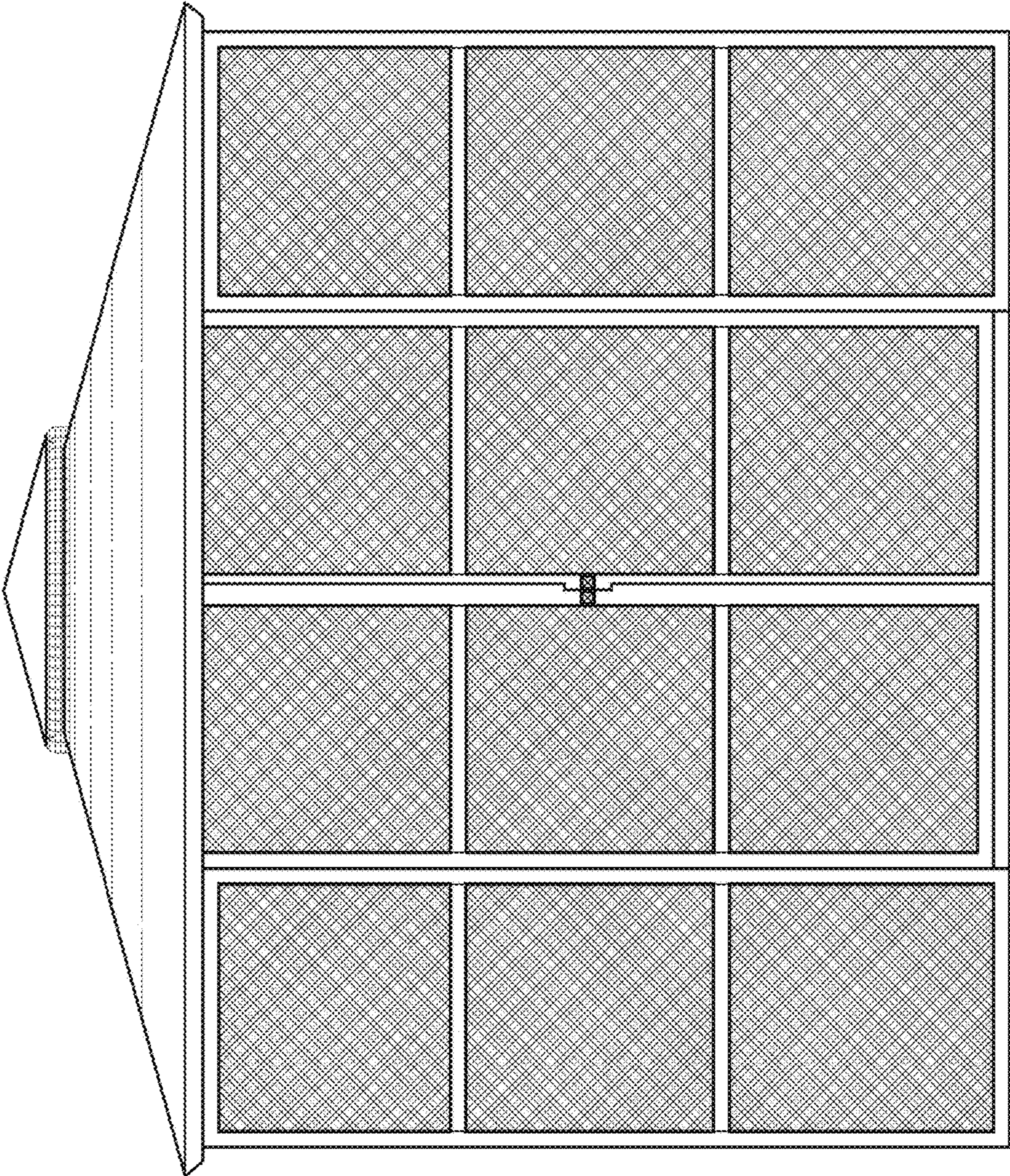
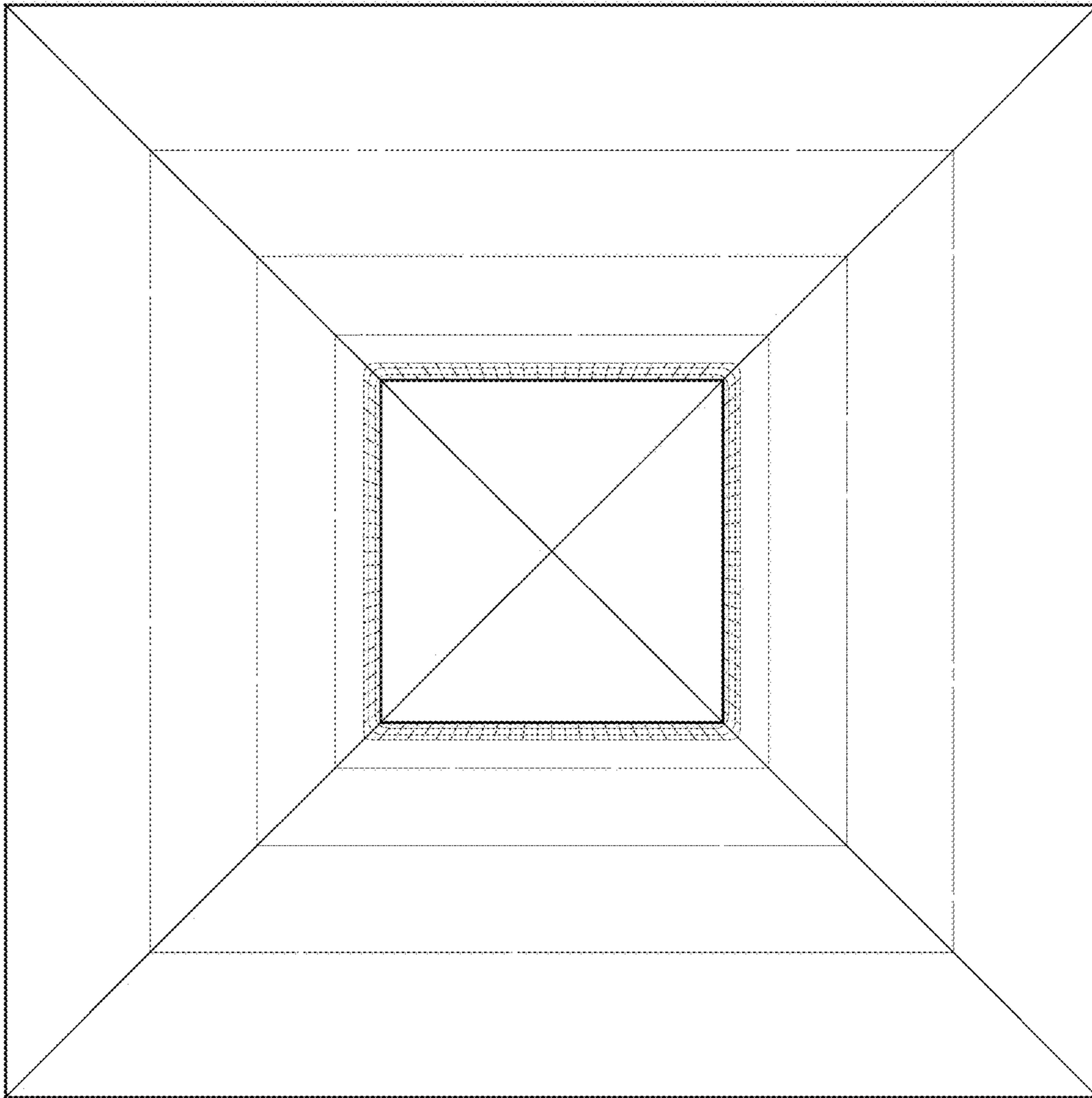

FIG. 2

FIG. 3



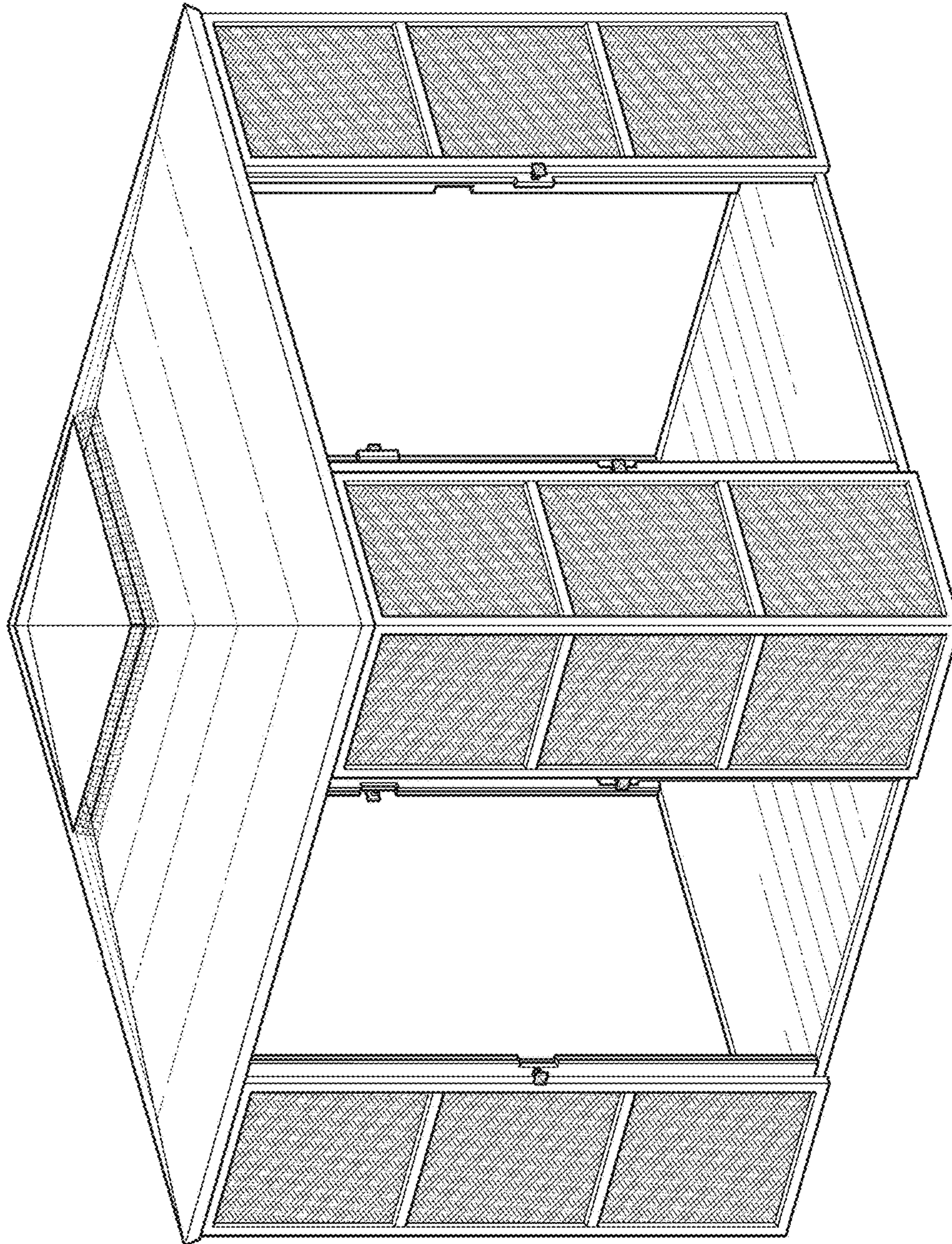

FIG. 4

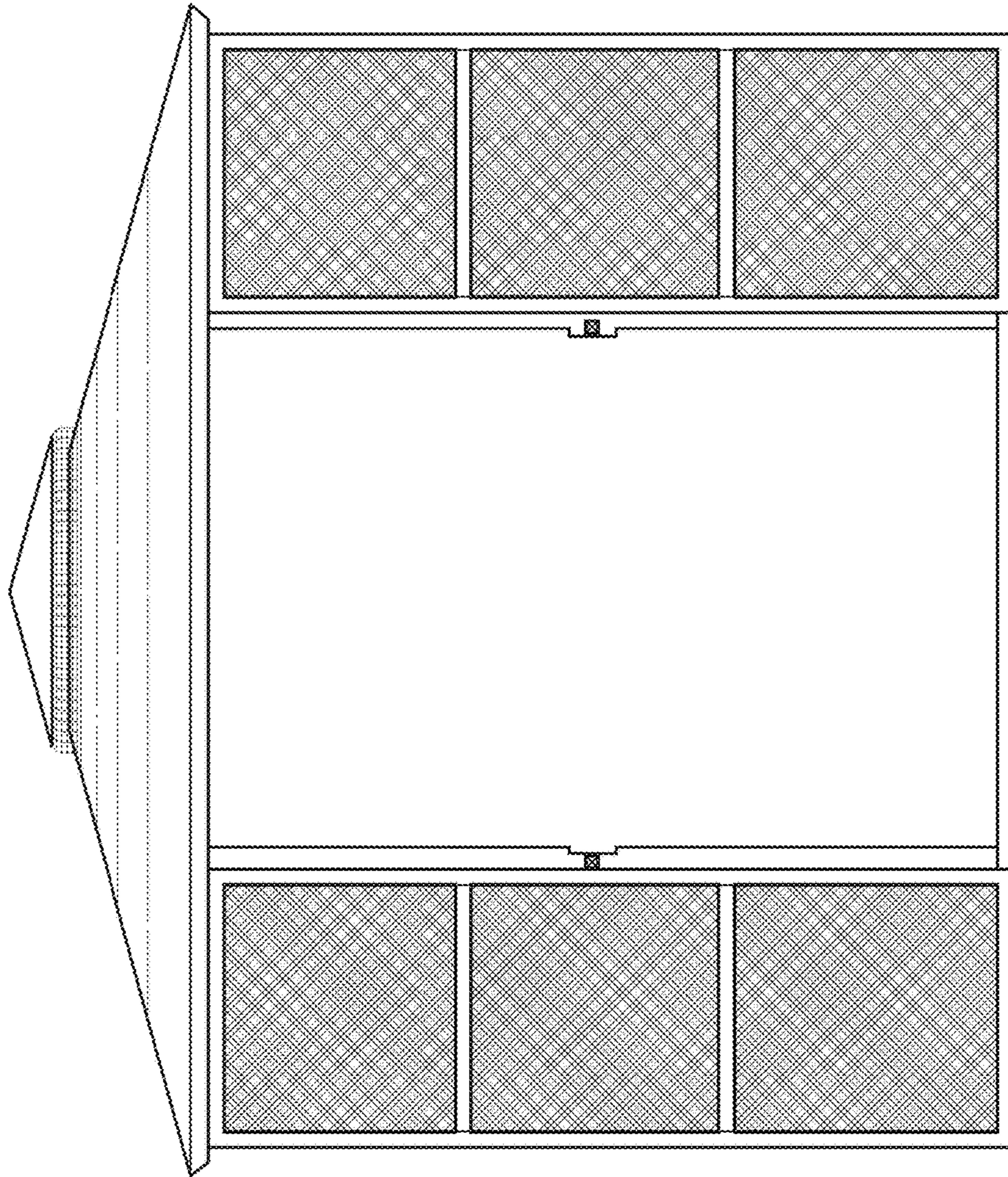

FIG. 5

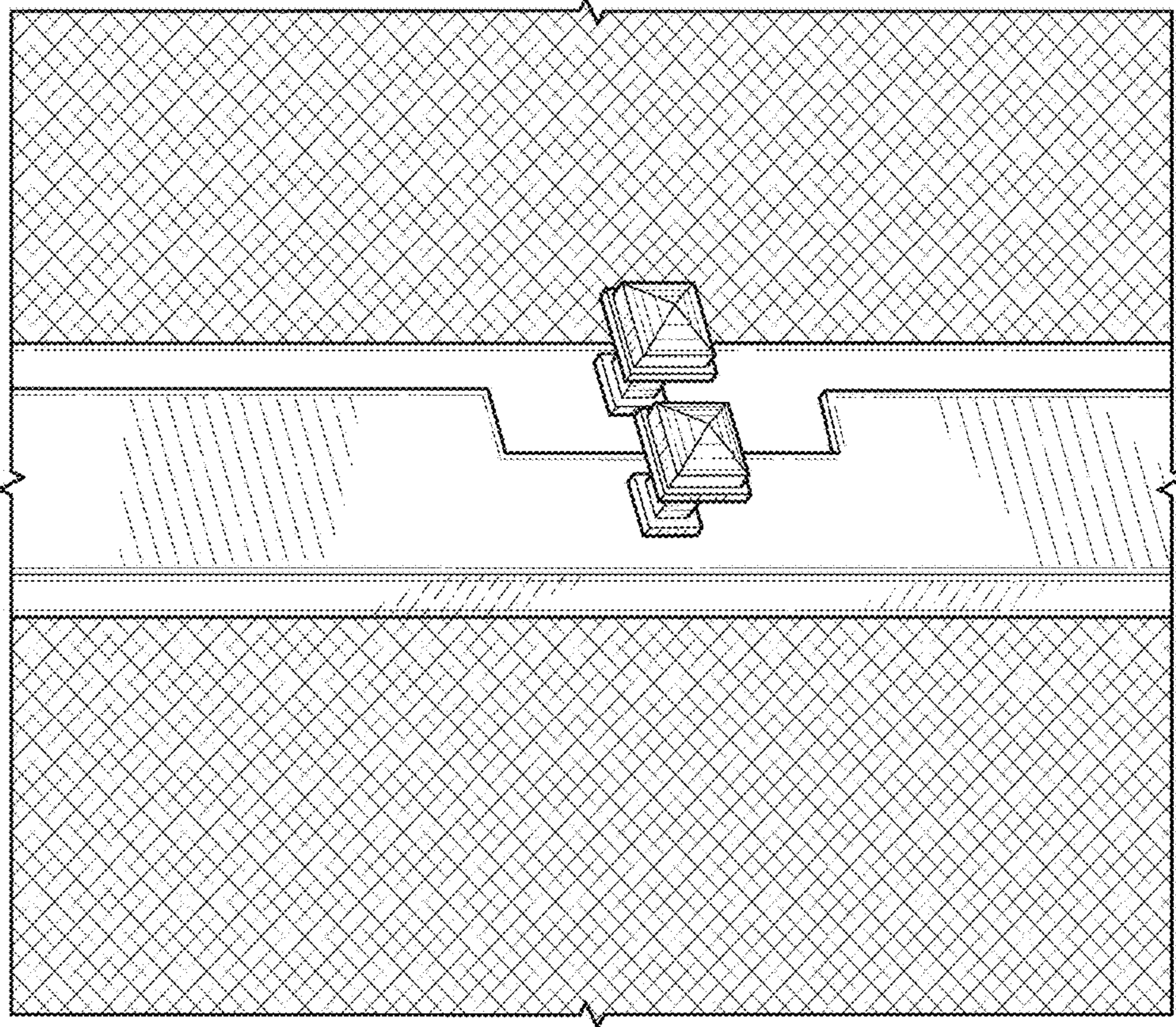

FIG. 6