



US00D850575S

(12) **United States Design Patent**
Valdivia

(10) **Patent No.:** **US D850,575 S**

(45) **Date of Patent:** **** Jun. 4, 2019**

- (54) **FISH HOOK PROTECTOR**
- (71) Applicant: **Leandro Valdivia**, Miami, FL (US)
- (72) Inventor: **Leandro Valdivia**, Miami, FL (US)
- (**) Term: **15 Years**
- (21) Appl. No.: **29/640,117**
- (22) Filed: **Mar. 12, 2018**
- (51) **LOC (11) Cl.** **22-05**
- (52) **U.S. Cl.**
USPC **D22/144**
- (58) **Field of Classification Search**
USPC D22/126-133, 144; 43/42.09, 43.6, 25.2,
43/57.1, 42.43
CPC A01K 83/00; A01K 85/02; A01K 97/06
See application file for complete search history.

- 5,123,199 A * 6/1992 Lysohir A01K 97/06
43/25.2
- D331,788 S * 12/1992 Jensen D22/126
- D375,539 S * 11/1996 Chu D22/144
- D675,285 S * 1/2013 Krammes D22/144
- D759,783 S * 6/2016 Tussey, III D22/144

* cited by examiner

Primary Examiner — Catherine R Oliver-Garcia
(74) *Attorney, Agent, or Firm* — Albert Bordas, P.A.

(56) **References Cited**

U.S. PATENT DOCUMENTS

- 2,743,547 A * 5/1956 Horst A01K 97/06
43/57.1
- D198,216 S * 5/1964 Chancellor D22/144
- 3,231,999 A * 2/1966 Gurka A01K 83/00
43/42.09
- 3,331,152 A * 7/1967 Starrett A01K 97/06
43/57.1
- 3,640,014 A * 2/1972 Gurka A01K 83/00
43/42.43
- D320,060 S * 9/1991 Austin D22/136
- D324,093 S * 2/1992 Wilson D22/144

(57) **CLAIM**

The ornamental design for a fish hook protector, as shown and described.

DESCRIPTION

FIG. 1 is a top plan view of a fish hook protector;
 FIG. 2 is a front elevational view thereof;
 FIG. 3 is a bottom view thereof;
 FIG. 4 is a left-side elevational view thereof, the right-side elevational view being a mirror image thereof;
 FIG. 5 is a rear elevational view thereof;
 FIG. 6 is a bottom isometric view thereof;
 FIG. 7 is a front isometric view thereof; and,
 FIG. 8 is a bottom isometric view thereof, showing my design in use.
 The broken lines represent environmental structure and form no part of the claimed design.

1 Claim, 3 Drawing Sheets

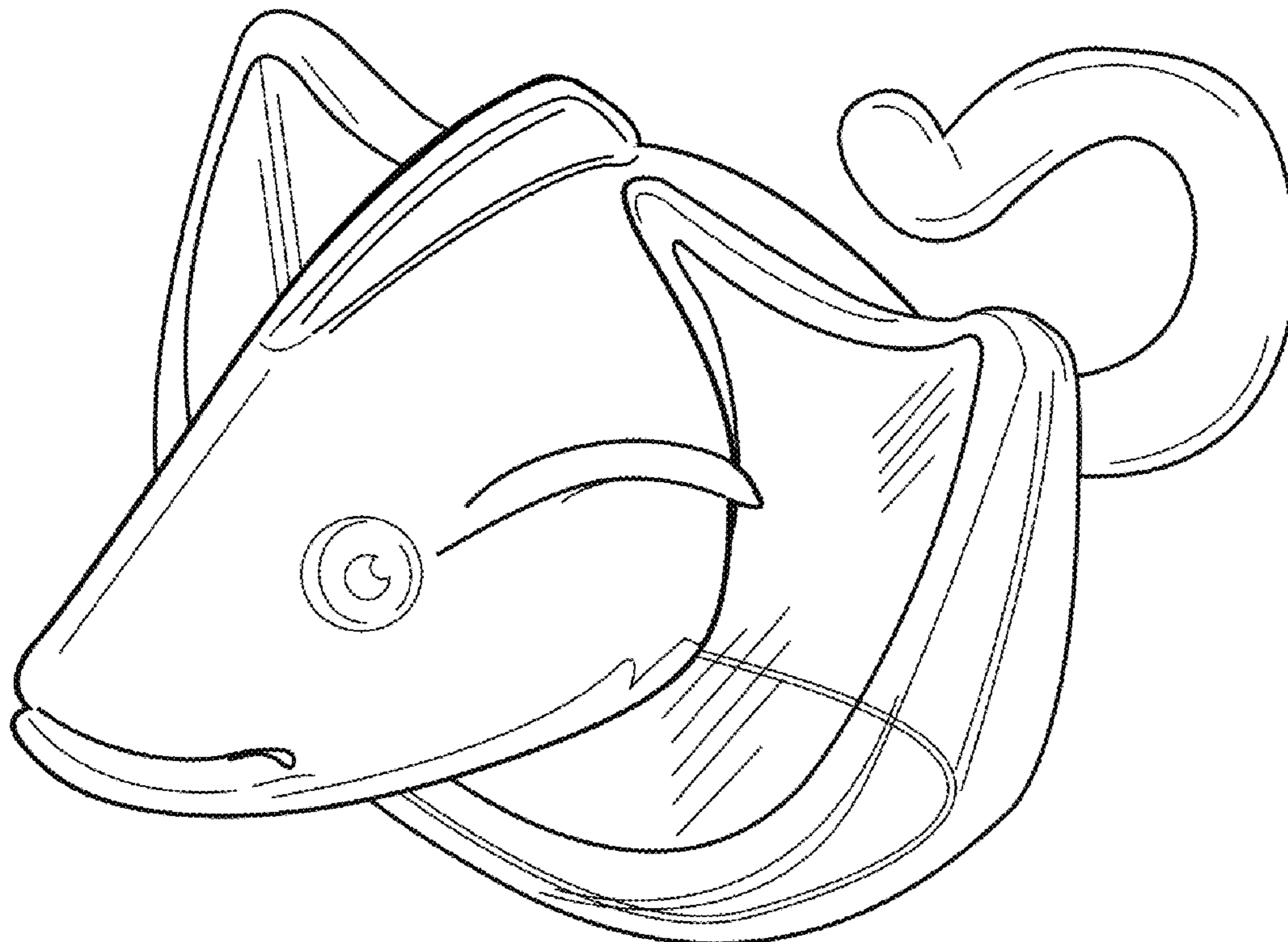

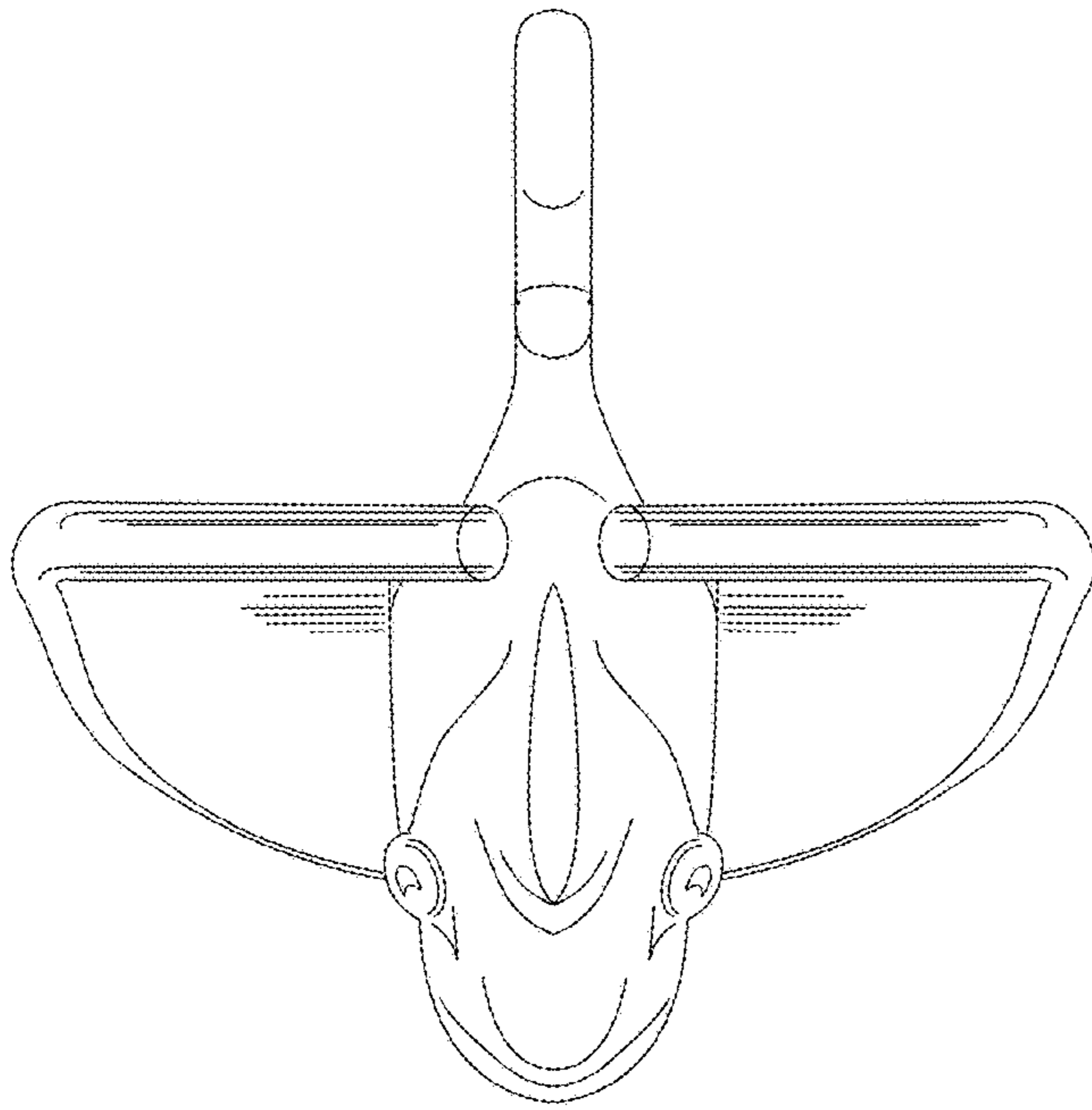

FIG. 1

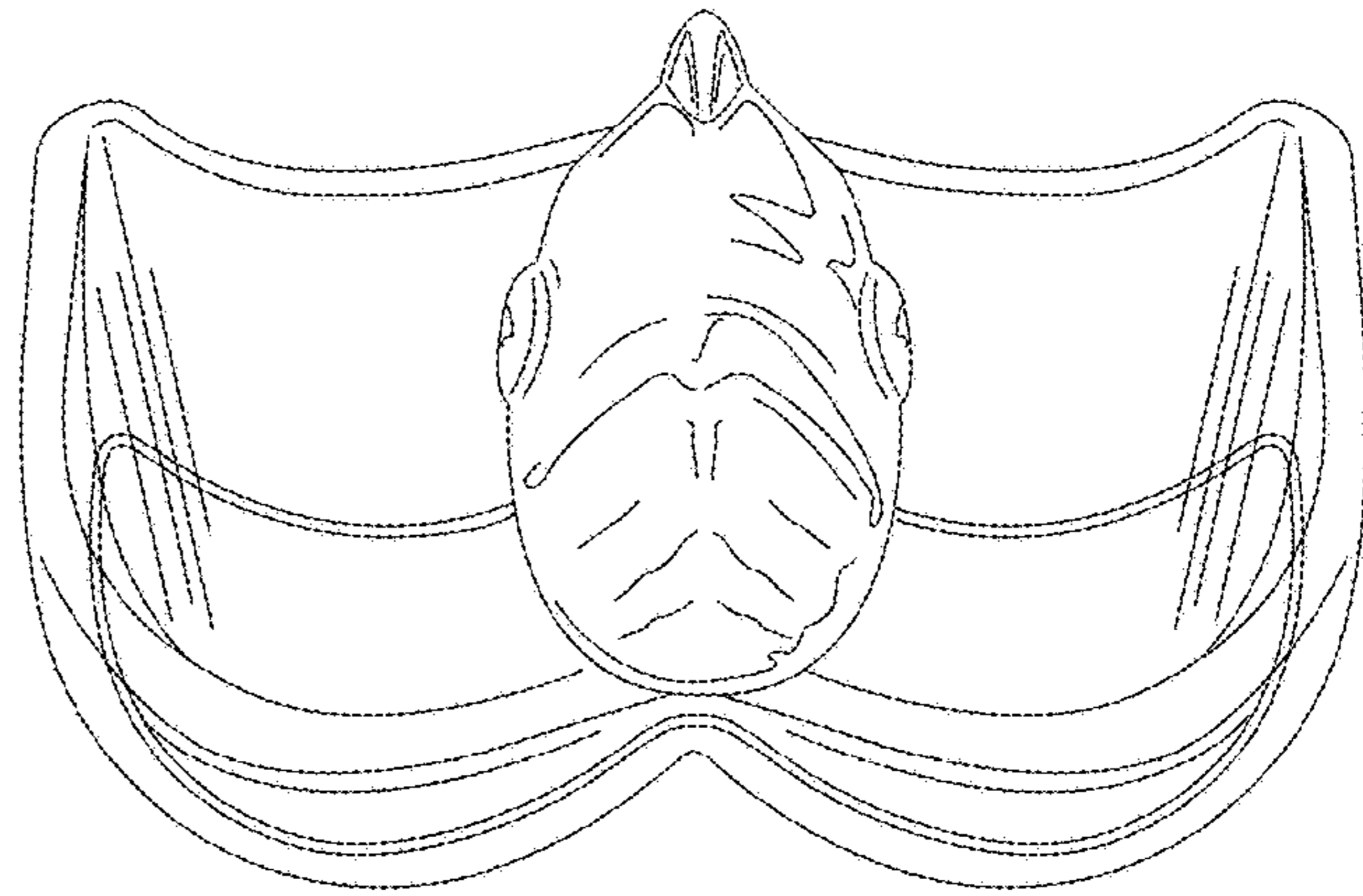

FIG. 2

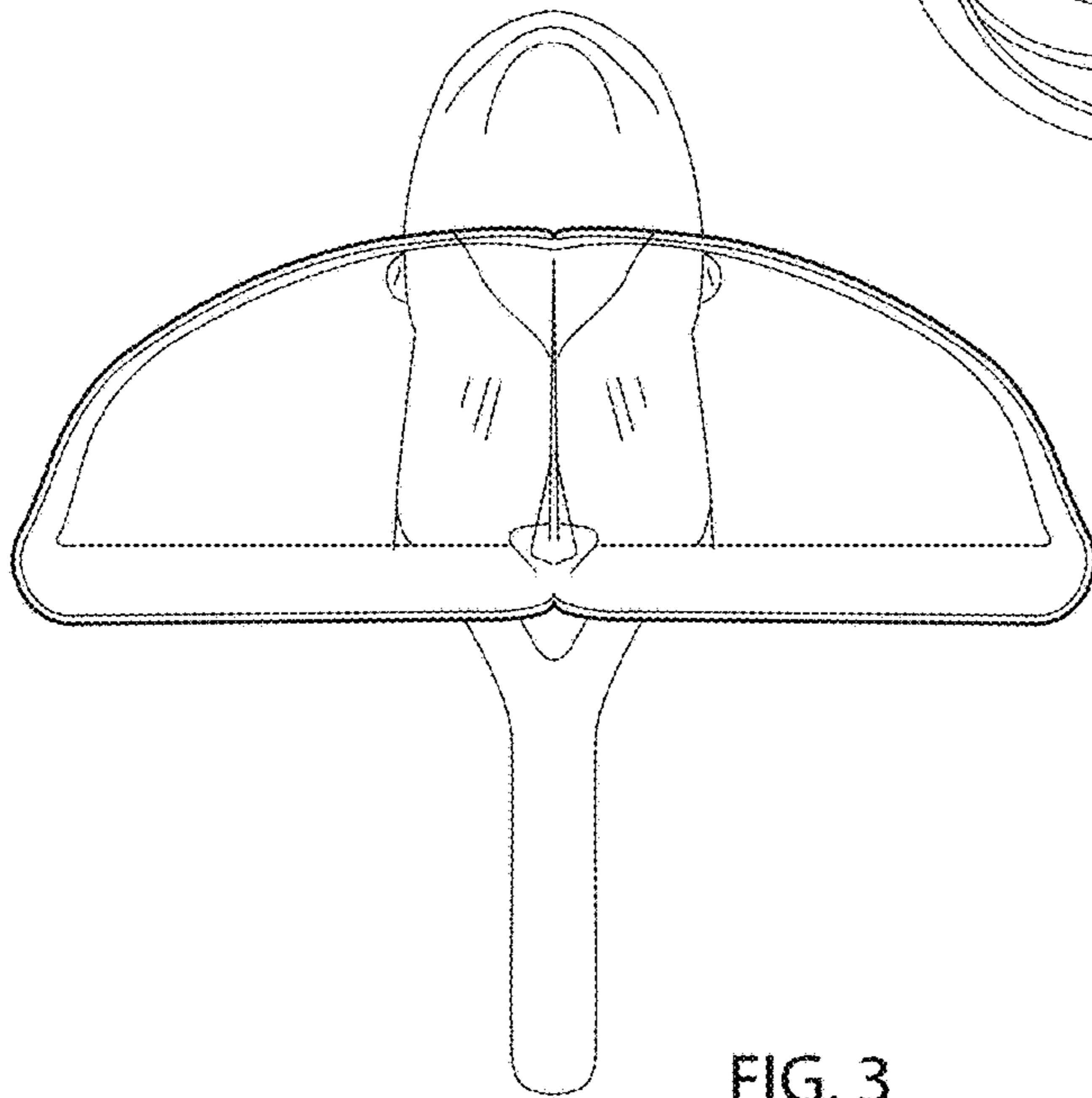

FIG. 3

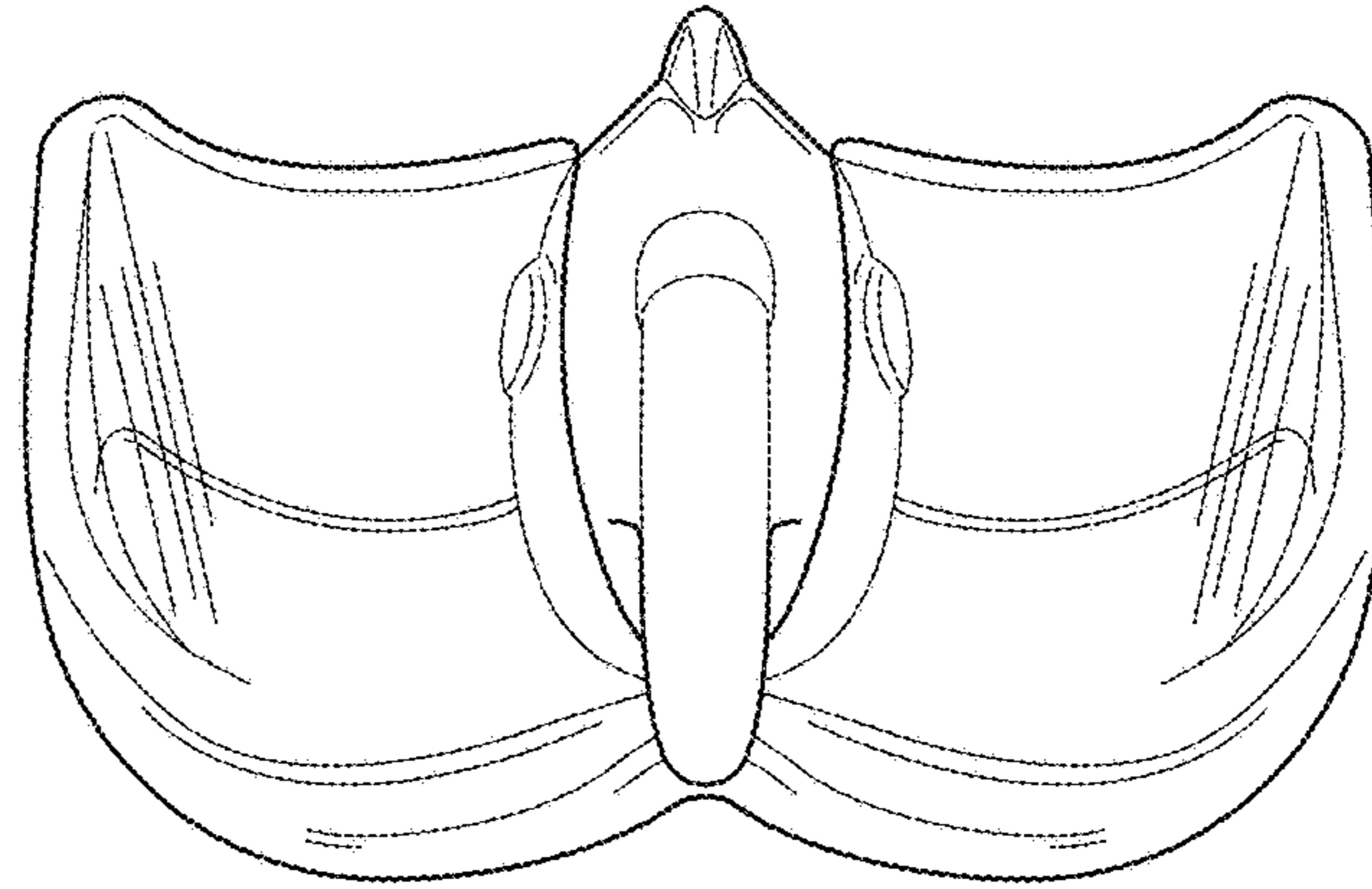

FIG. 5

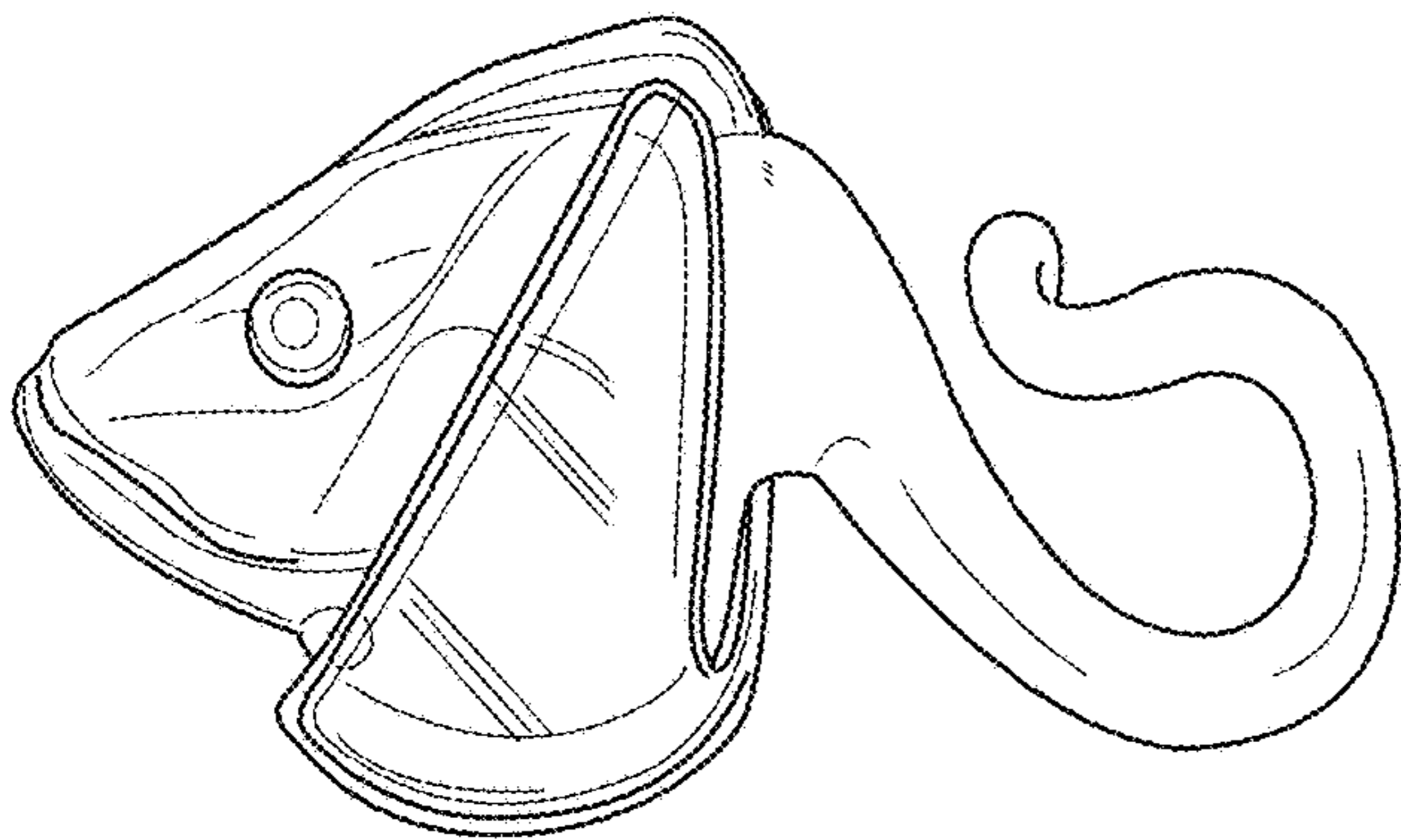

FIG. 4

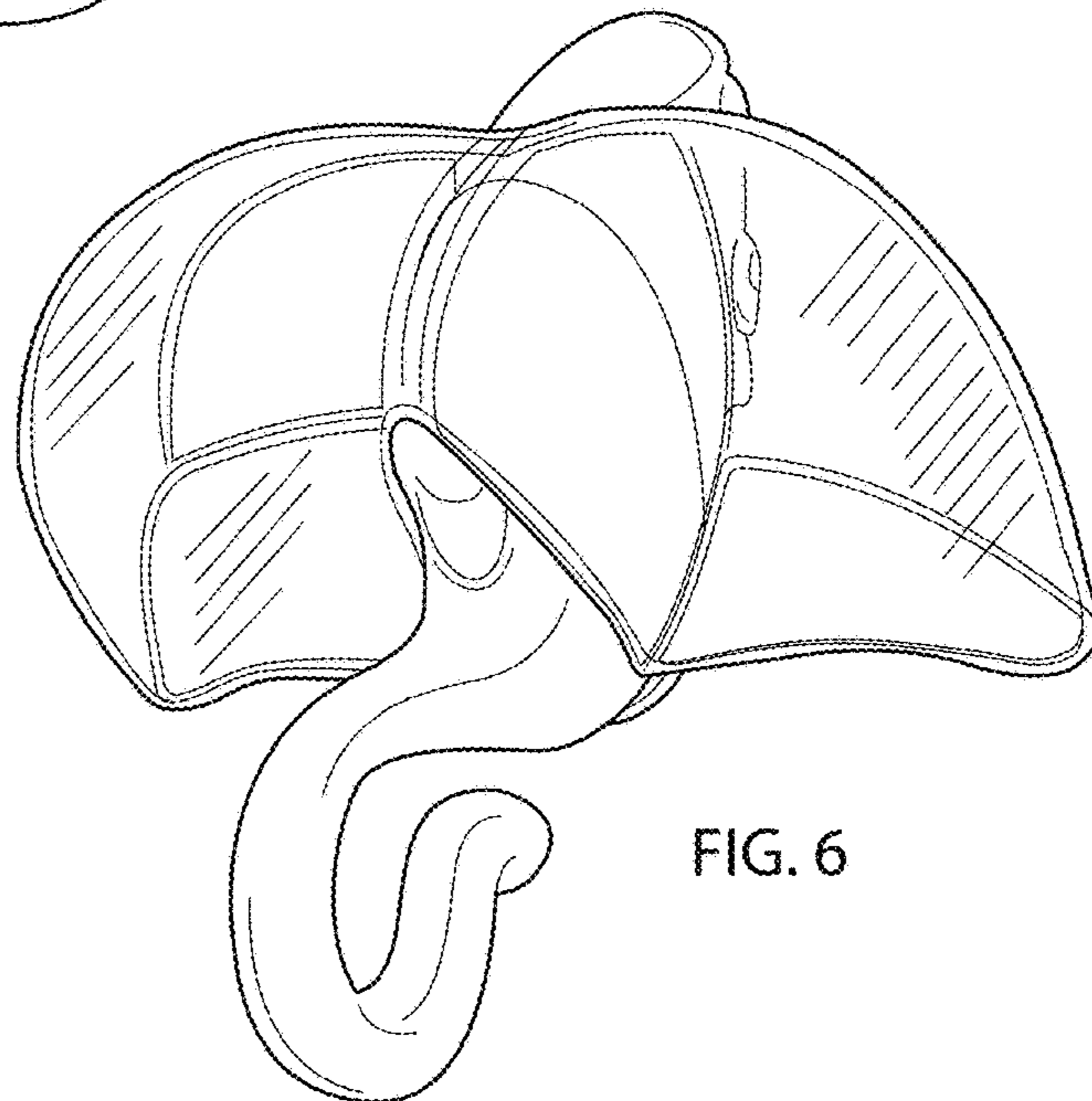

FIG. 6

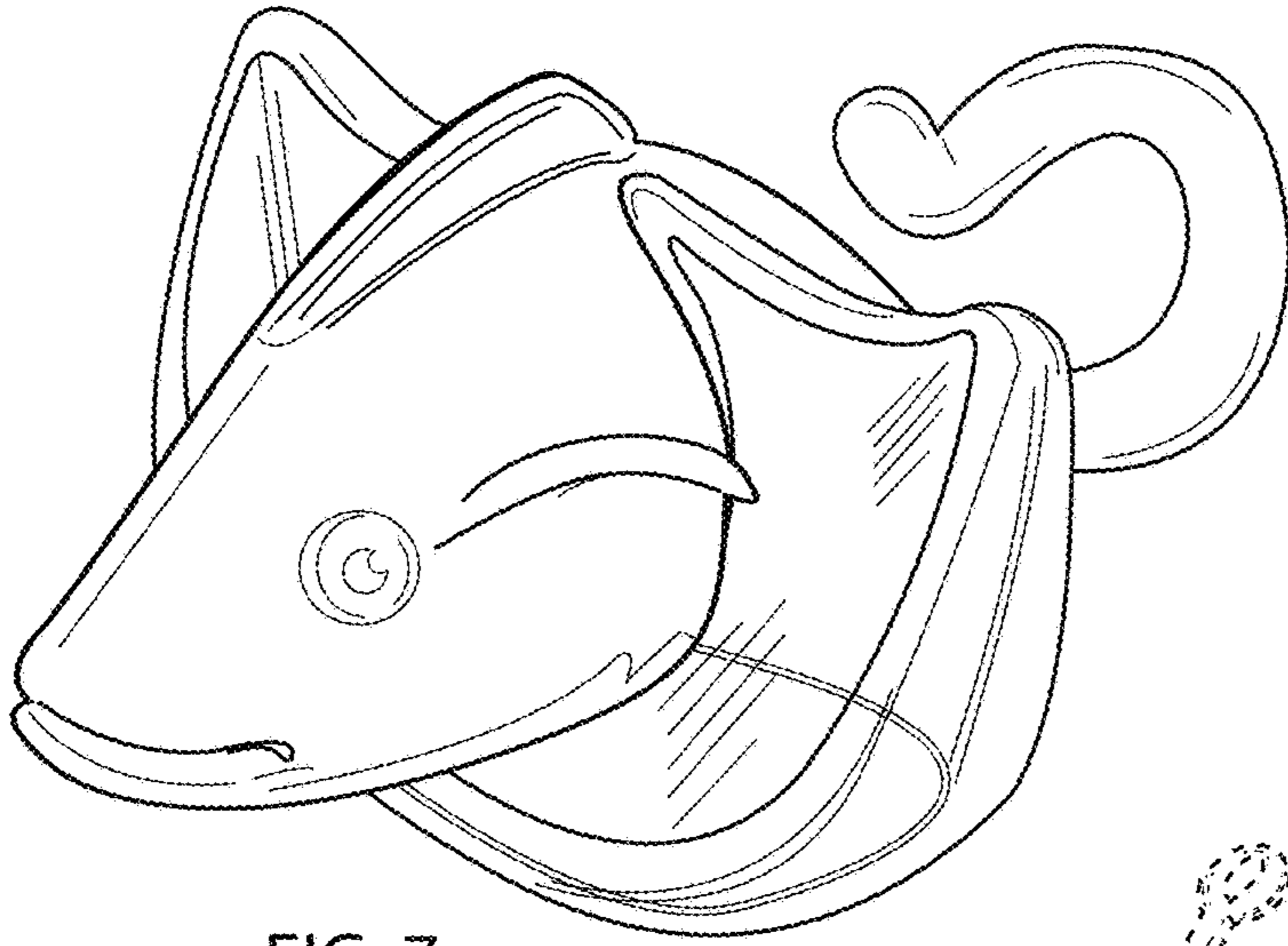

FIG. 7

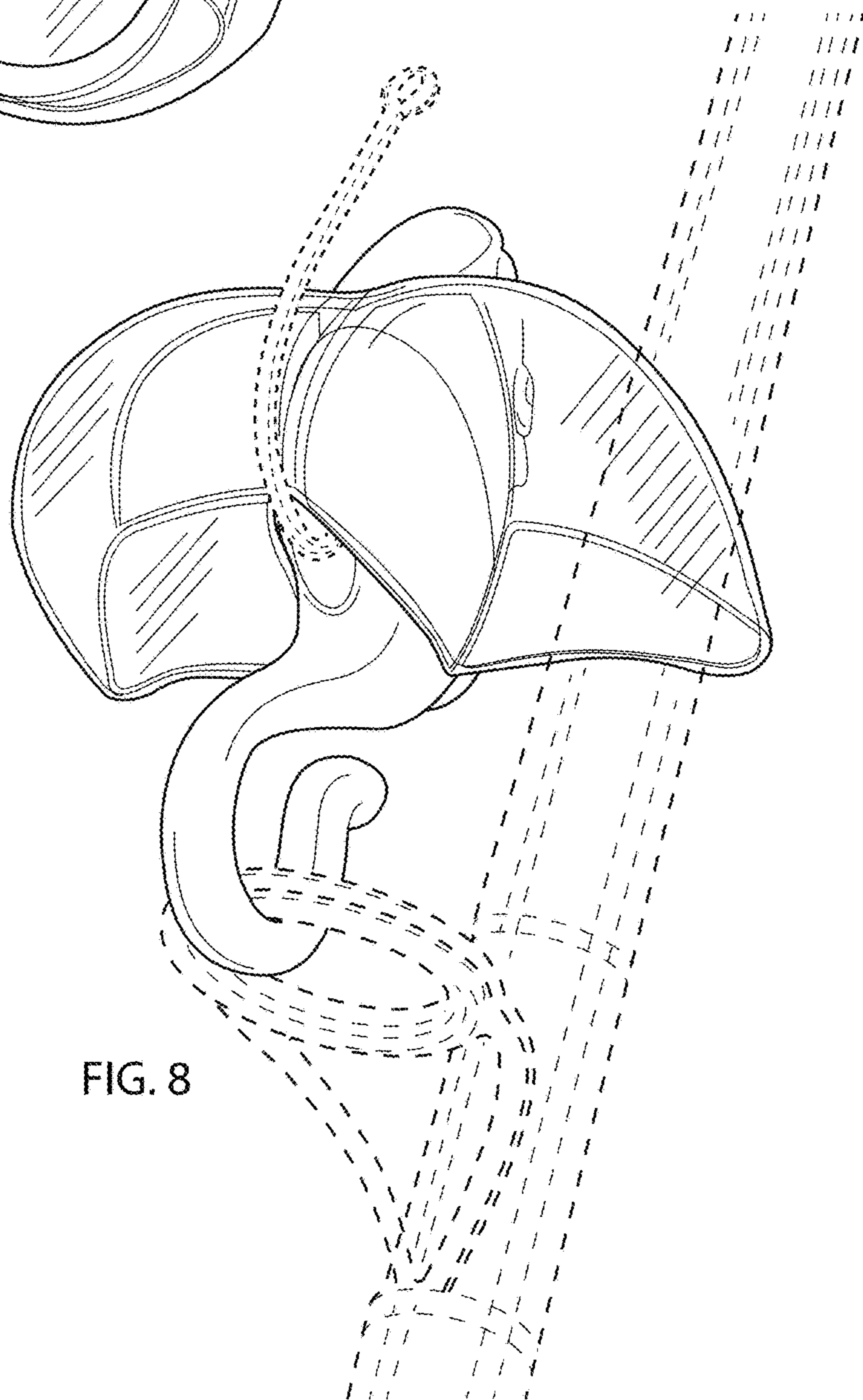

FIG. 8