



US00D850572S

(12) **United States Design Patent**
Lieberwirth et al.

(10) **Patent No.:** **US D850,572 S**
(45) **Date of Patent:** **** Jun. 4, 2019**

- (54) **INSECT TRAP**
- (71) Applicant: **The Procter & Gamble Company**,
Cincinnati, OH (US)
- (72) Inventors: **Lars Lieberwirth**, Shanghai (CN);
Andrew F Sandford, Marlborough,
MA (US); **Daniel B Lazarchik**, Boston,
MA (US)
- (73) Assignee: **The Procter & Gamble Company**,
Cincinnati, OH (US)
- (**) Term: **15 Years**
- (21) Appl. No.: **29/590,625**
- (22) Filed: **Jan. 12, 2017**

Related U.S. Application Data

- (60) Division of application No. 29/565,260, filed on May 19, 2016, now Pat. No. Des. 780,284, which is a continuation of application No. 29/503,040, filed on Sep. 23, 2014, now abandoned, which is a continuation of application No. 29/476,091, filed on Dec. 11, 2013, now abandoned, which is a continuation of application No. 29/449,887, filed on Mar. 15, 2013, now abandoned.

- (51) **LOC (11) Cl.** **22-06**
- (52) **U.S. Cl.**
USPC **D22/122**
- (58) **Field of Classification Search**
USPC D22/119–124; 43/107, 121, 124, 131,
43/132.1; D23/366–367
CPC A01M 1/04; A01M 1/14
See application file for complete search history.

(56) **References Cited**

U.S. PATENT DOCUMENTS

- 2,307,163 A 1/1943 Shea
- 3,729,858 A 5/1973 Bradshaw

- 4,212,129 A 7/1980 Shumate
- D282,390 S 1/1986 Ford et al.
- 4,709,502 A 12/1987 Bierman
- 4,709,503 A 12/1987 McQueen
- 4,815,231 A 3/1989 McQueen
- D323,014 S 1/1992 Demarest et al.
- D326,702 S 6/1992 Demarest
- D357,725 S 4/1995 Biasetti
- 5,556,192 A 9/1996 Wang
- 5,572,825 A 11/1996 Gehret
- 5,588,250 A 12/1996 Chiba et al.
- 6,108,965 A 8/2000 Burrows et al.
- D457,591 S 5/2002 Christianson et al.
- 6,392,549 B1 5/2002 Wu
- 6,393,759 B1 5/2002 Brown
- 6,478,440 B1 11/2002 Jaworski et al.
- D467,295 S 12/2002 Andrews et al.
- 6,560,919 B2 5/2003 Burrows et al.
- 6,886,292 B2 5/2005 Studer et al.
- D521,102 S 5/2006 Hoyes
- D533,930 S 12/2006 Keller, Jr. et al.
- 7,607,255 B2 10/2009 Hu
- D612,039 S 3/2010 Ko et al.

(Continued)

Primary Examiner — Catherine R Oliver-Garcia
(74) *Attorney, Agent, or Firm* — Melissa G. Krasovec

(57) **CLAIM**

The ornamental design for an insect trap, as shown and described.

DESCRIPTION

FIG. 1 is a front perspective view of an ornamental design for an insect trap;
FIG. 2 is a rear perspective view thereof;
FIG. 3 is a rear view thereof;
FIG. 4 is a front view thereof;
FIG. 5 is a side view thereof;
FIG. 6 is an opposite side view thereof;
FIG. 7 is a top view thereof; and,
FIG. 8 is a bottom view.

1 Claim, 4 Drawing Sheets

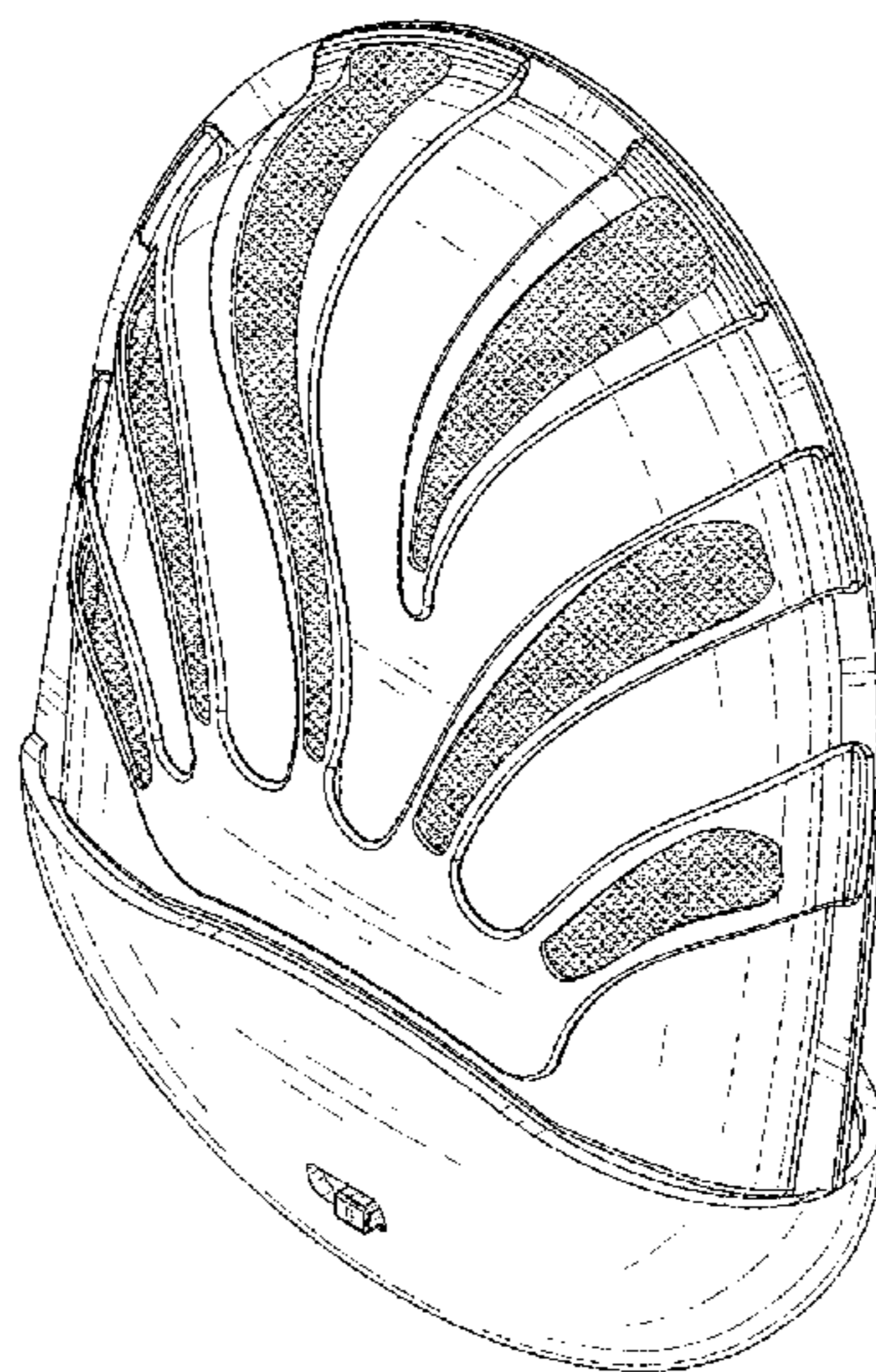

(56)

References Cited

U.S. PATENT DOCUMENTS

| | | | |
|--------------|----|---------|--------------------|
| D612,446 | S | 3/2010 | Galili |
| D614,278 | S | 4/2010 | Schwartz et al. |
| D629,500 | S | 12/2010 | Koenig et al. |
| 7,856,752 | B1 | 12/2010 | Eilerson |
| 8,016,207 | B2 | 9/2011 | Kvietok et al. |
| 8,099,900 | B2 | 1/2012 | Rivera |
| 8,109,036 | B1 | 2/2012 | Wilbanks |
| 8,210,448 | B2 | 7/2012 | Kvietok et al. |
| D669,151 | S | 10/2012 | Frisch |
| 8,375,625 | B2 | 2/2013 | Larsen |
| 8,707,614 | B2 | 4/2014 | Larsen |
| 8,740,110 | B2 | 6/2014 | Gruenbacher et al. |
| 9,089,121 | B2 | 7/2015 | Diclaro et al. |
| D736,341 | S | 8/2015 | Lieberwirth et al. |
| 2009/0100743 | A1 | 4/2009 | Prater |
| 2010/0263260 | A1 | 10/2010 | Engelbrecht et al. |
| 2016/0000060 | A1 | 1/2016 | Sandford et al. |

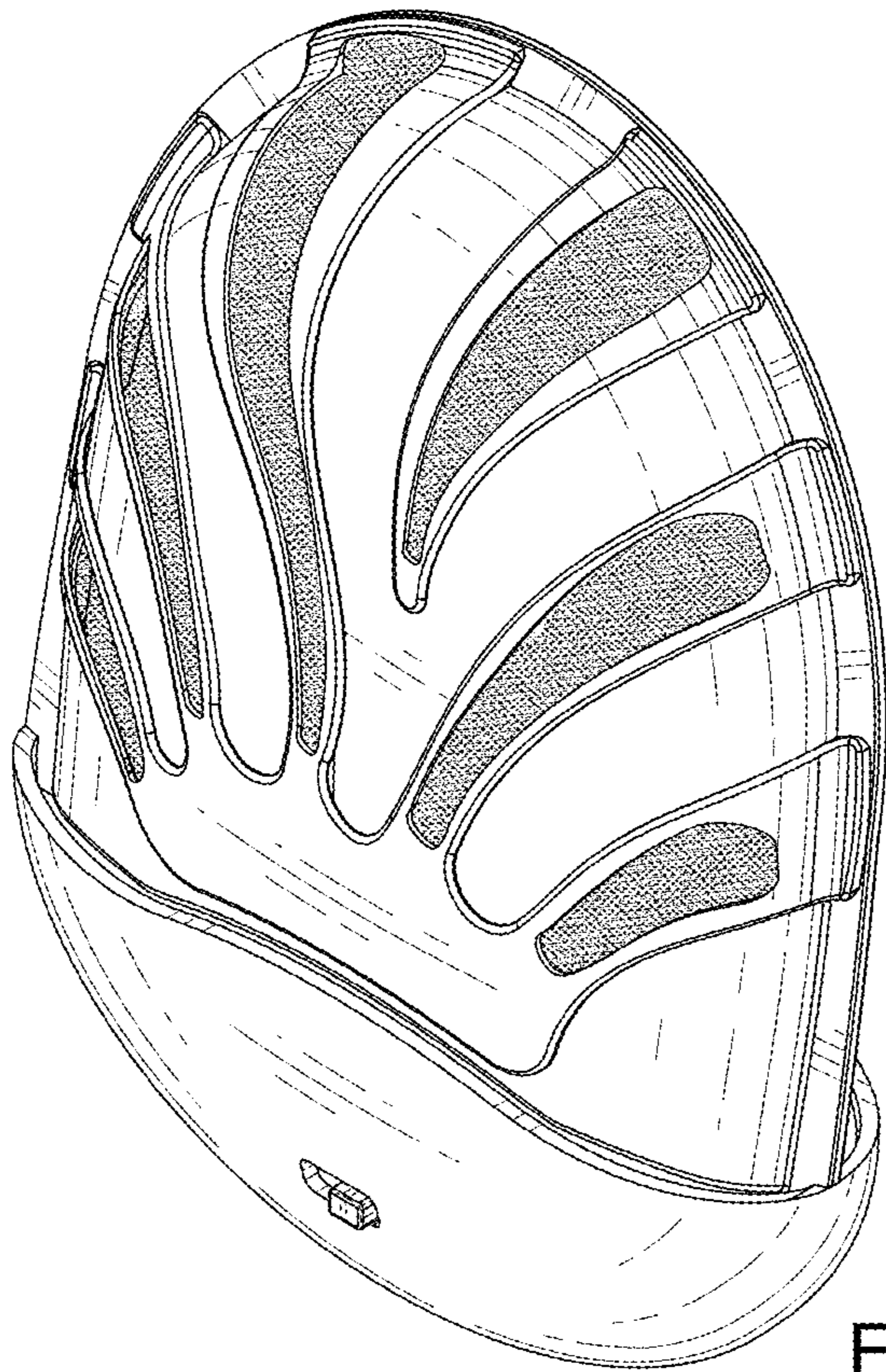

FIG. 1

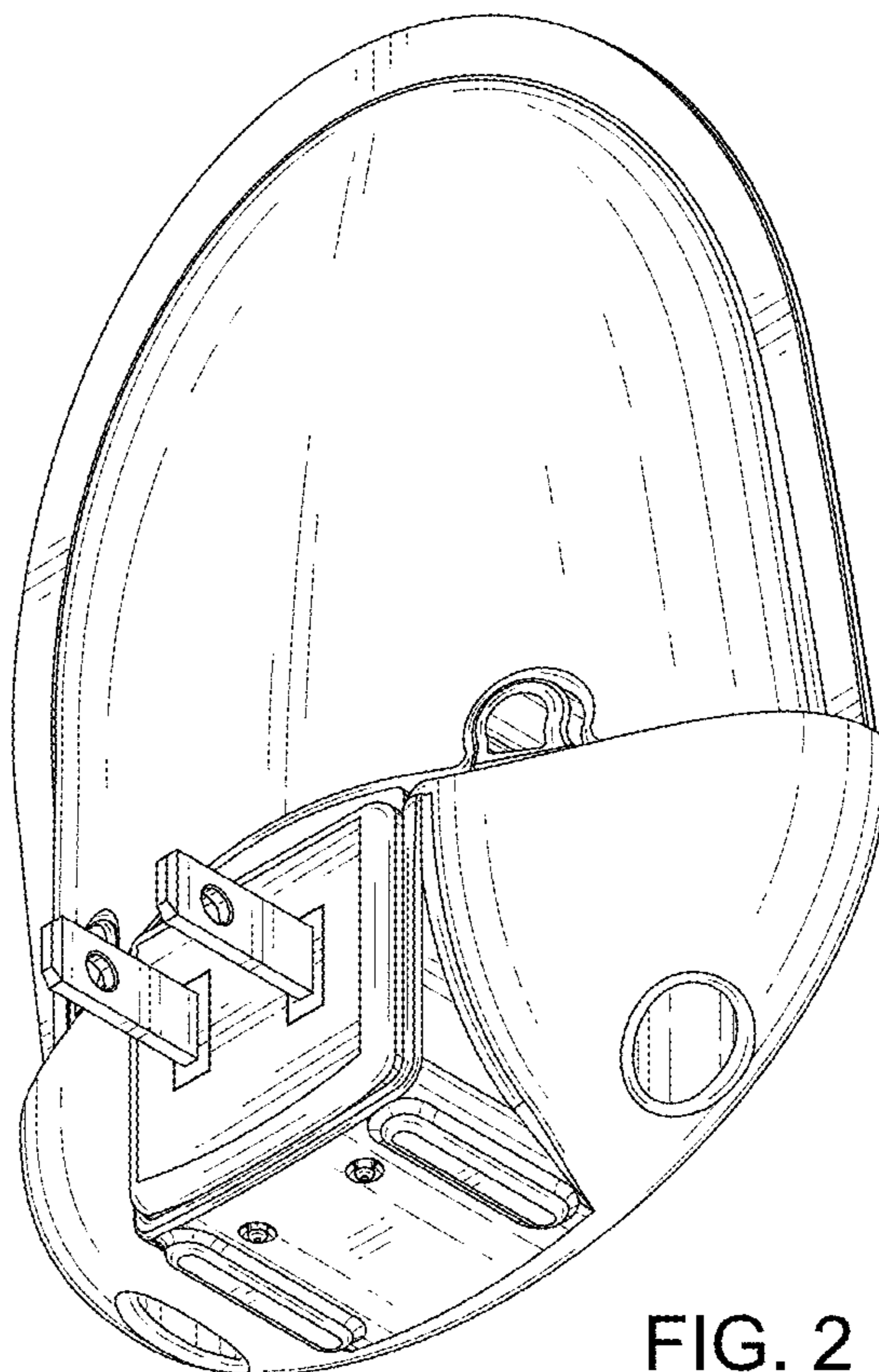

FIG. 2

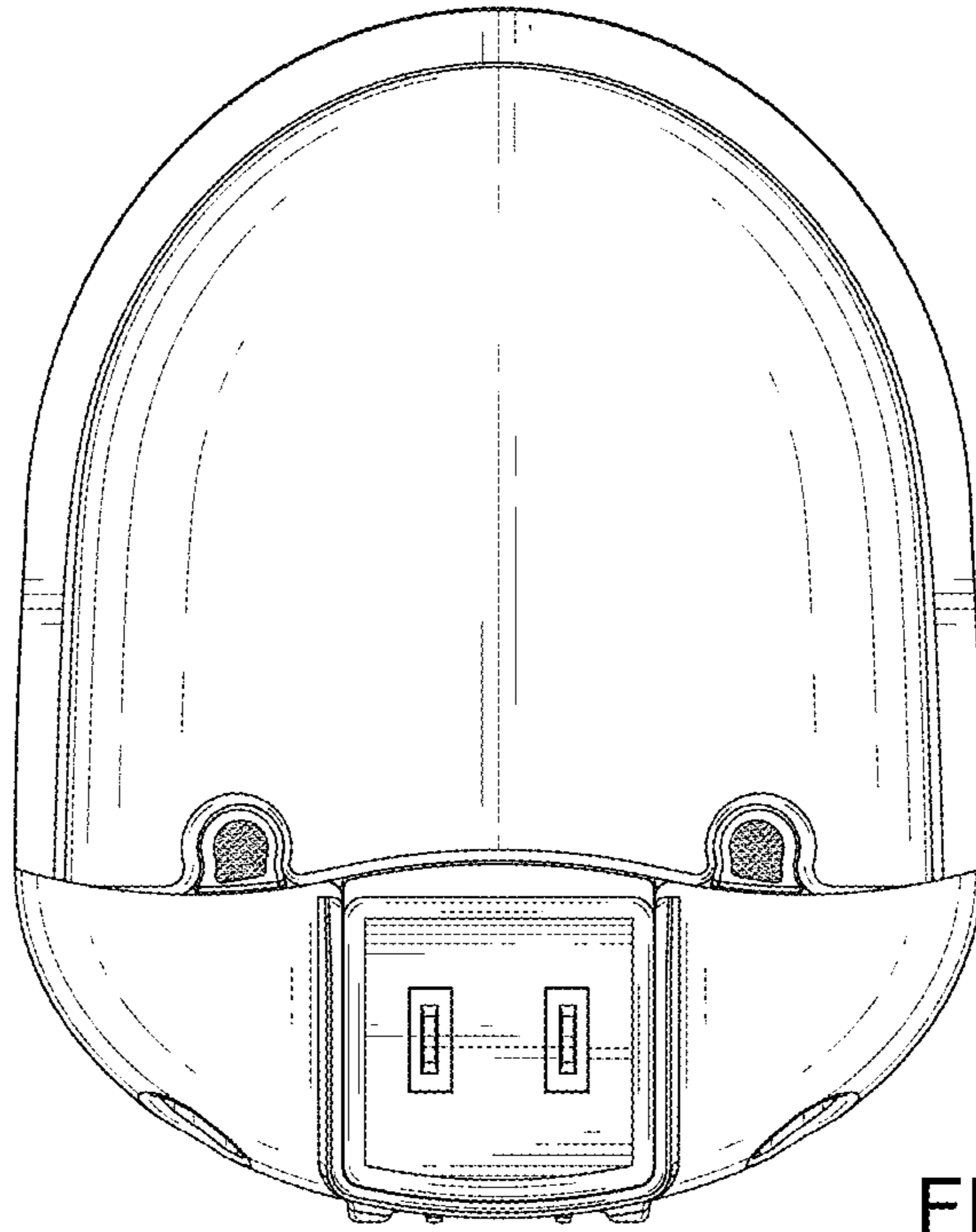

FIG. 3

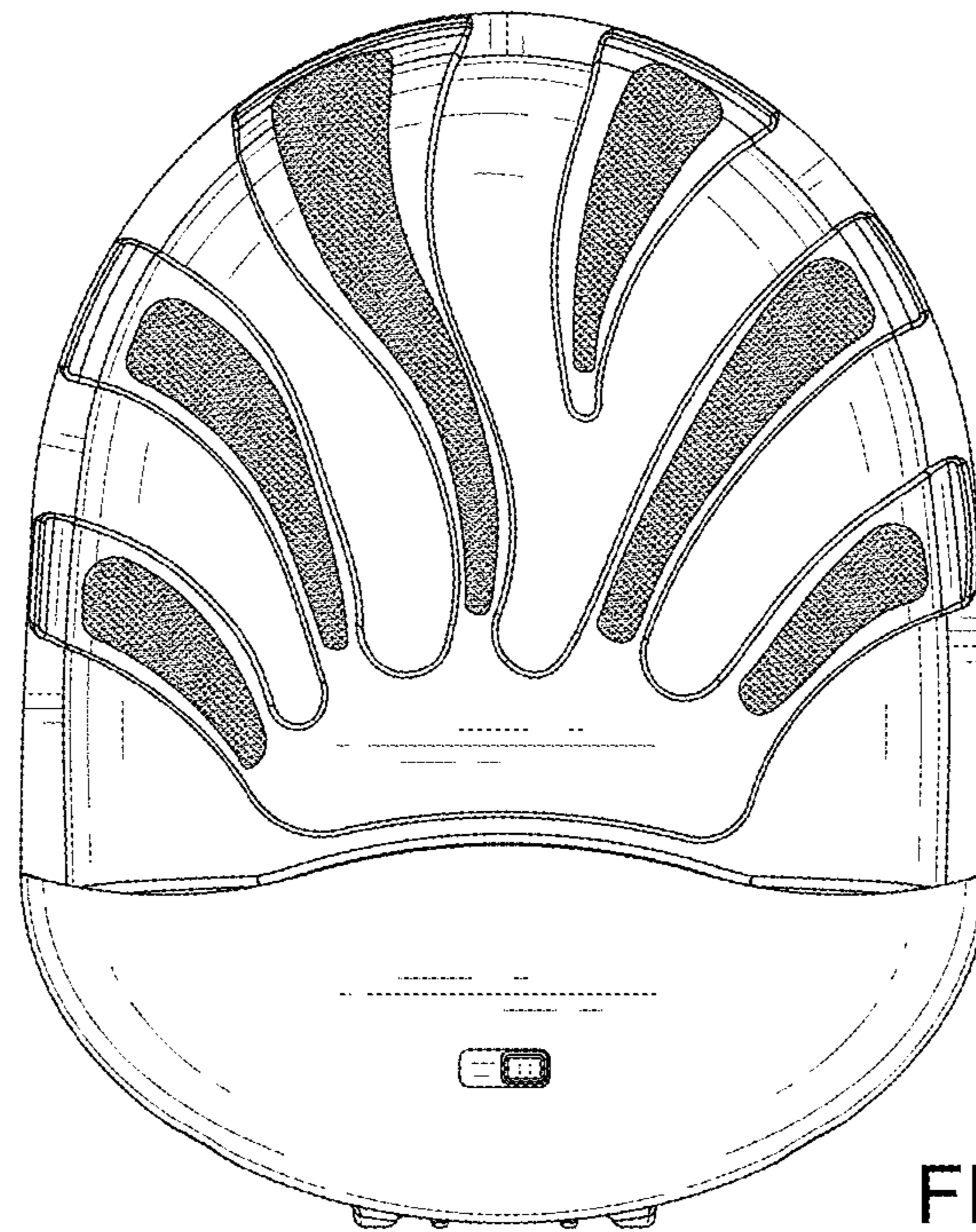

FIG. 4

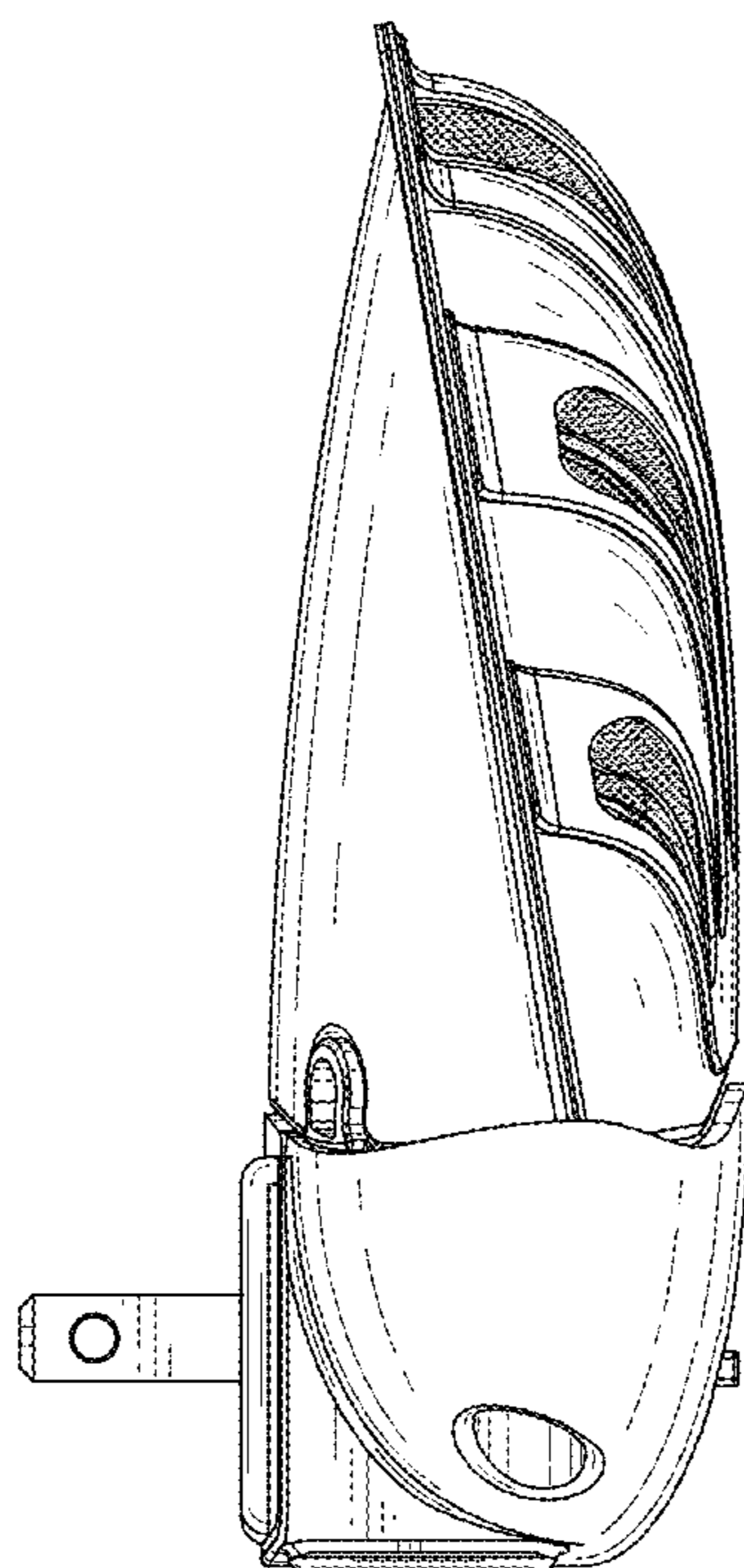

FIG. 5

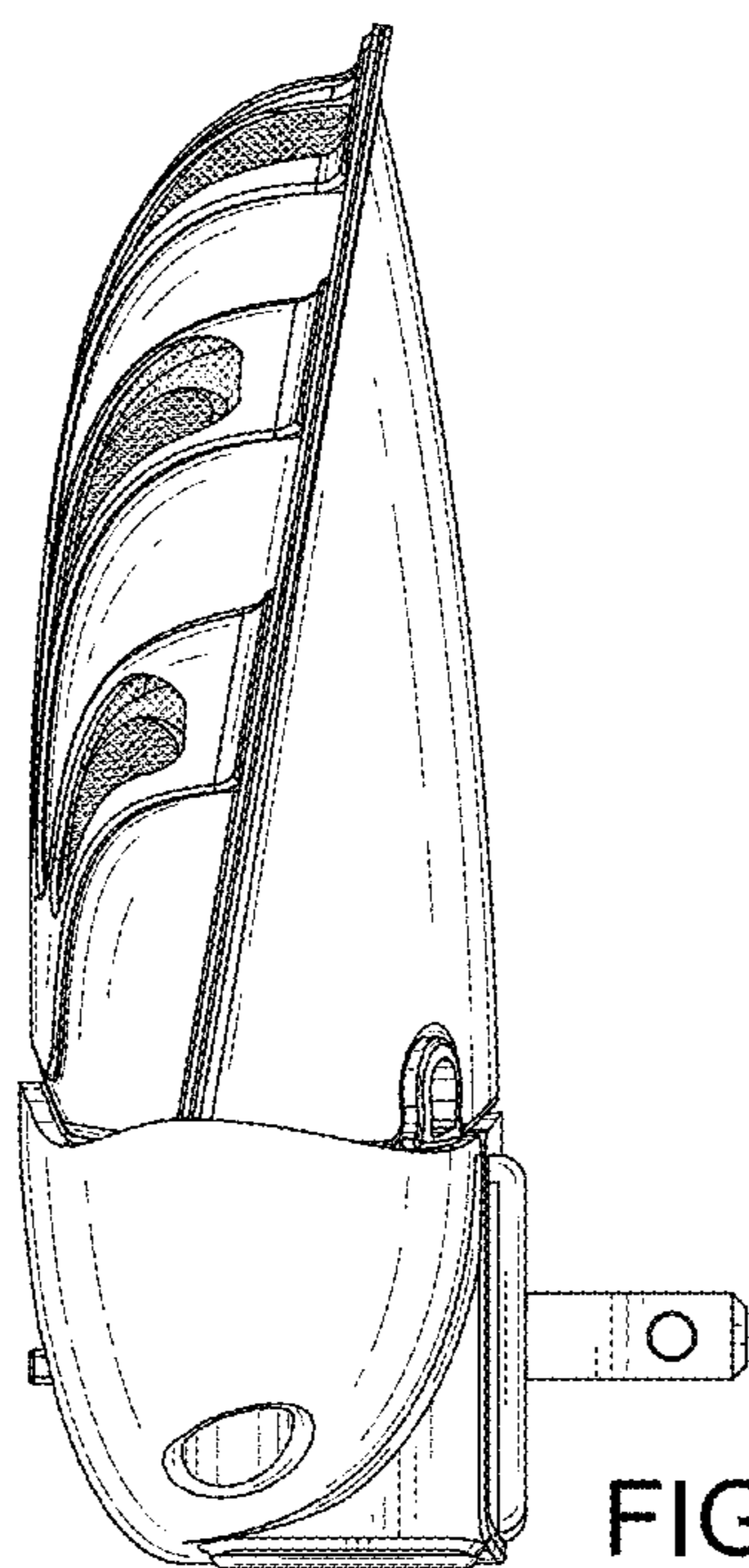

FIG. 6

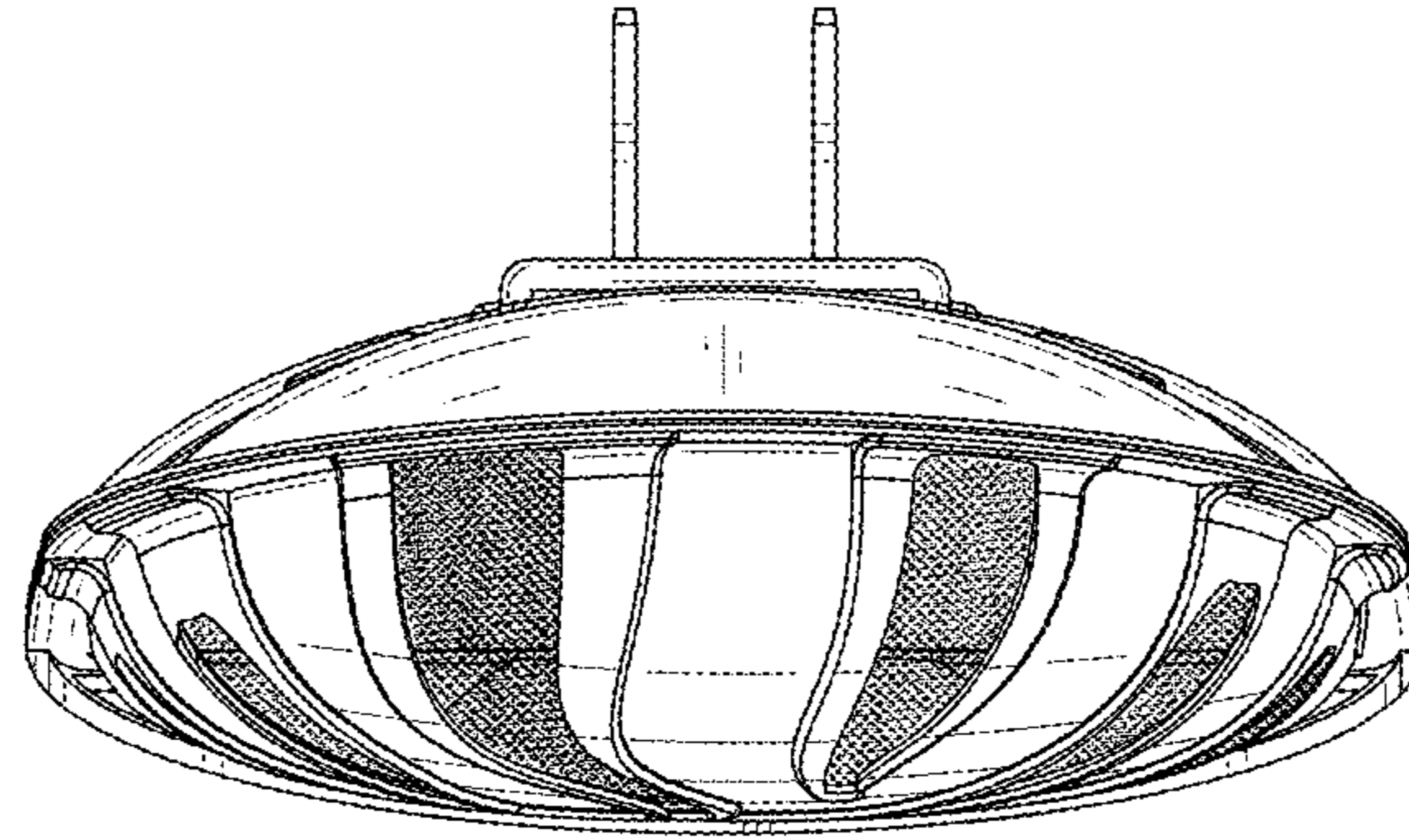

FIG. 7

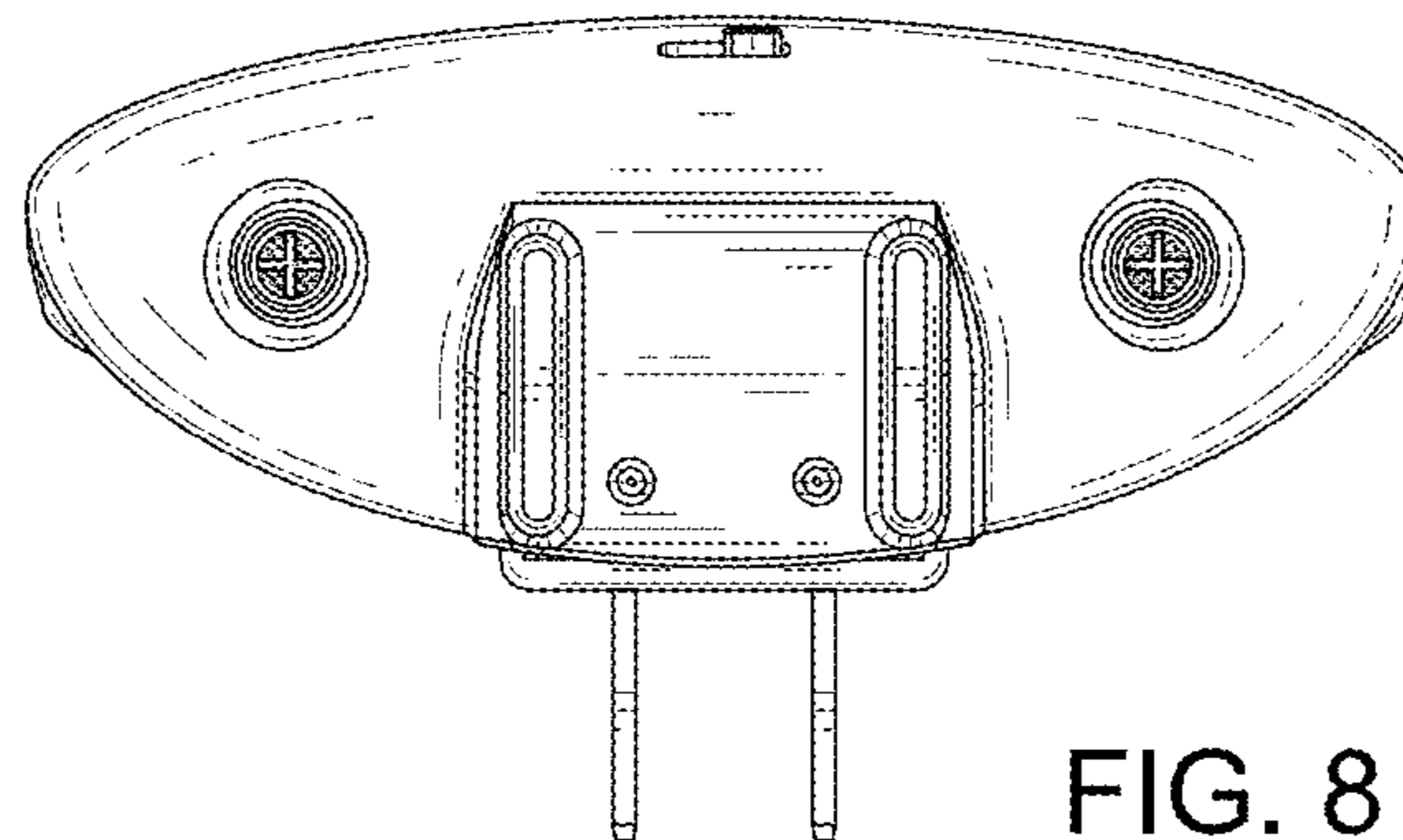

FIG. 8