



US00D850440S

(12) **United States Design Patent** (10) **Patent No.:** **US D850,440 S**  
**Gentle et al.** (45) **Date of Patent:** **\*\* Jun. 4, 2019**

- (54) **TABLE TOP TOUCH SCREEN**
- (71) Applicant: **RGB Systems, Inc.**, Anaheim, CA (US)
- (72) Inventors: **Kate N. Gentle**, Anaheim, CA (US);  
**John Weldon Gammon**, Anaheim, CA (US); **David H. Libman**, Anaheim, CA (US)
- (73) Assignee: **RGB Systems, Inc.**, Anaheim, CA (US)
- (\*\*) Term: **15 Years**
- (21) Appl. No.: **29/628,454**
- (22) Filed: **Dec. 5, 2017**
- (51) **LOC (11) Cl.** ..... **14-02**
- (52) **U.S. Cl.**  
USPC ..... **D14/336**
- (58) **Field of Classification Search**  
USPC ..... D14/336, 341, 447-452, 371, 373, 374,  
D14/375, 376, 377, 126, 127, 128, 129  
CPC ..... G06F 1/1601; G06F 1/1605; G06F 1/162  
See application file for complete search history.

(56) **References Cited**

**U.S. PATENT DOCUMENTS**

D212,886 S	*	12/1968	Gordon	.....	D6/310
D335,963 S	*	6/1993	Tracey	.....	D6/300
D585,652 S	*	2/2009	Kuo	.....	D6/308
D608,547 S	*	1/2010	Peng	.....	D6/310
D682,272 S	*	5/2013	Kim	.....	D14/374
D703,311 S	*	4/2014	Daly	.....	D24/110
D744,446 S	*	12/2015	Kim	.....	D14/126
D763,216 S	*	8/2016	Han	.....	D14/126
D784,270 S	*	4/2017	Bhattacharya	.....	D13/162
D789,362 S	*	6/2017	Eljas	.....	D14/366

(Continued)

**OTHER PUBLICATIONS**

Extron. Link: <https://www.extron.com/product/tlppro725t?s=4>. Visited Sep. 17, 2018. TLP Pro 725T. (Year: 2018).\*

*Primary Examiner* — Bridget L Eland  
*Assistant Examiner* — Lauren D McVey  
(74) *Attorney, Agent, or Firm* — Knobbe, Martens, Olson & Bear LLP

(57) **CLAIM**

The ornamental design for a table top touch screen, as shown and described.

**DESCRIPTION**

FIG. 1 is a top perspective view of a first embodiment of a table top touch screen showing our new design; FIG. 2 is a bottom perspective view thereof; FIG. 3 is a front view thereof; FIG. 4 is a rear view thereof; FIG. 5 is a left side view thereof; FIG. 6 is a right side view thereof; FIG. 7 is a top view thereof; FIG. 8 is a bottom view thereof; FIG. 9 is a top perspective view of a second embodiment of a table top touch screen showing our new design; FIG. 10 is a bottom perspective view thereof; FIG. 11 is a front view thereof; FIG. 12 is a rear view thereof; FIG. 13 is a left side view thereof; FIG. 14 is a right side view thereof; FIG. 15 is a top view thereof; and, FIG. 16 is a bottom view thereof.

The “Extron” lettering and icon forming part of the disclosure is a registered trademark of RGB Systems, Inc. The broken lines shown in the figures that are immediately adjacent to the claim represent the bounds of the claimed design, while all other broken lines including: on the front surface the letters near the bottom edge (of embodiments one and two), rectangle substantially centered (of embodiment one), three circles and two obround shapes near the top edge (of embodiment one) are directed to environment; the broken lines form no part of the claimed design.

**1 Claim, 14 Drawing Sheets**

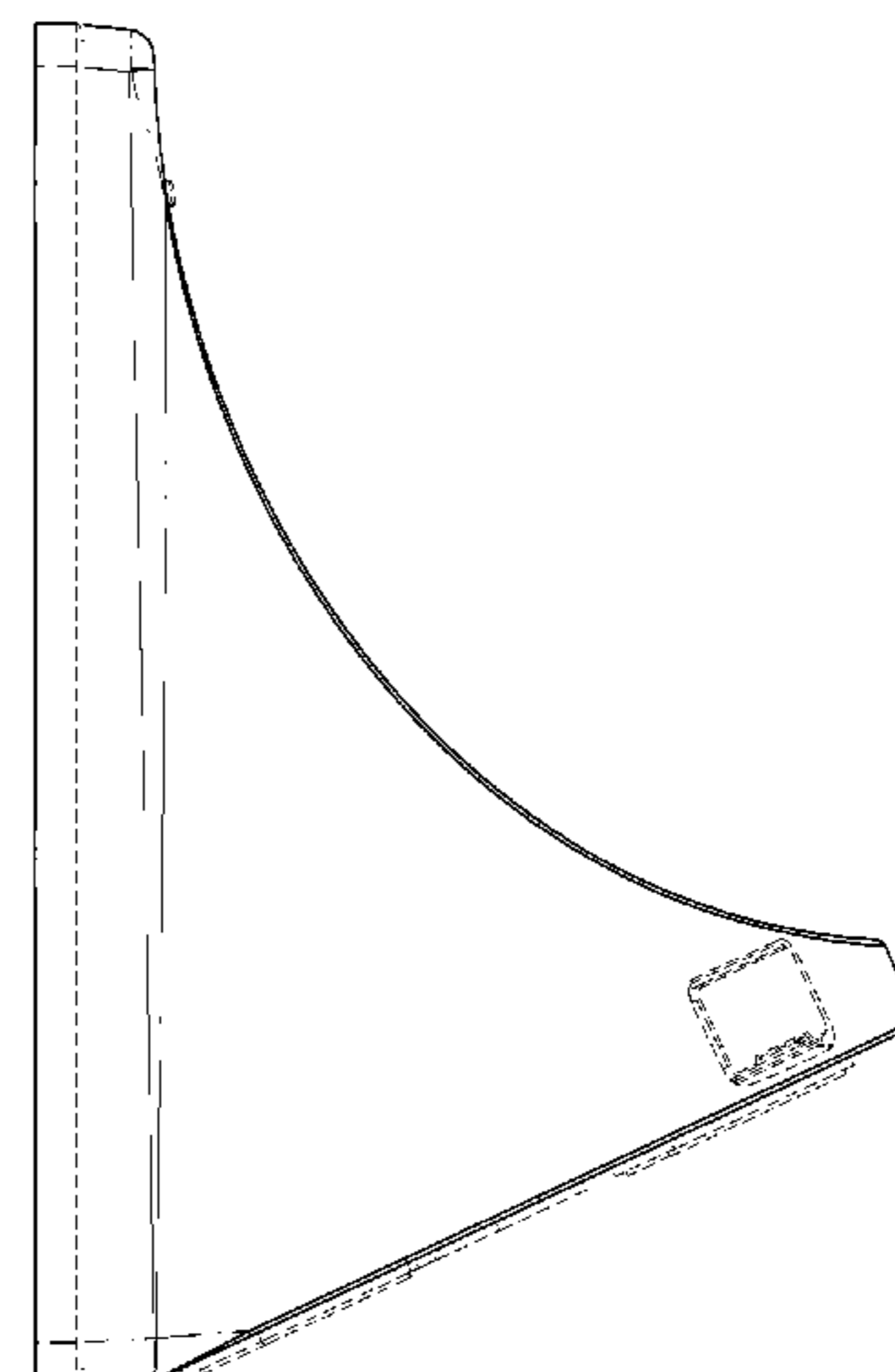
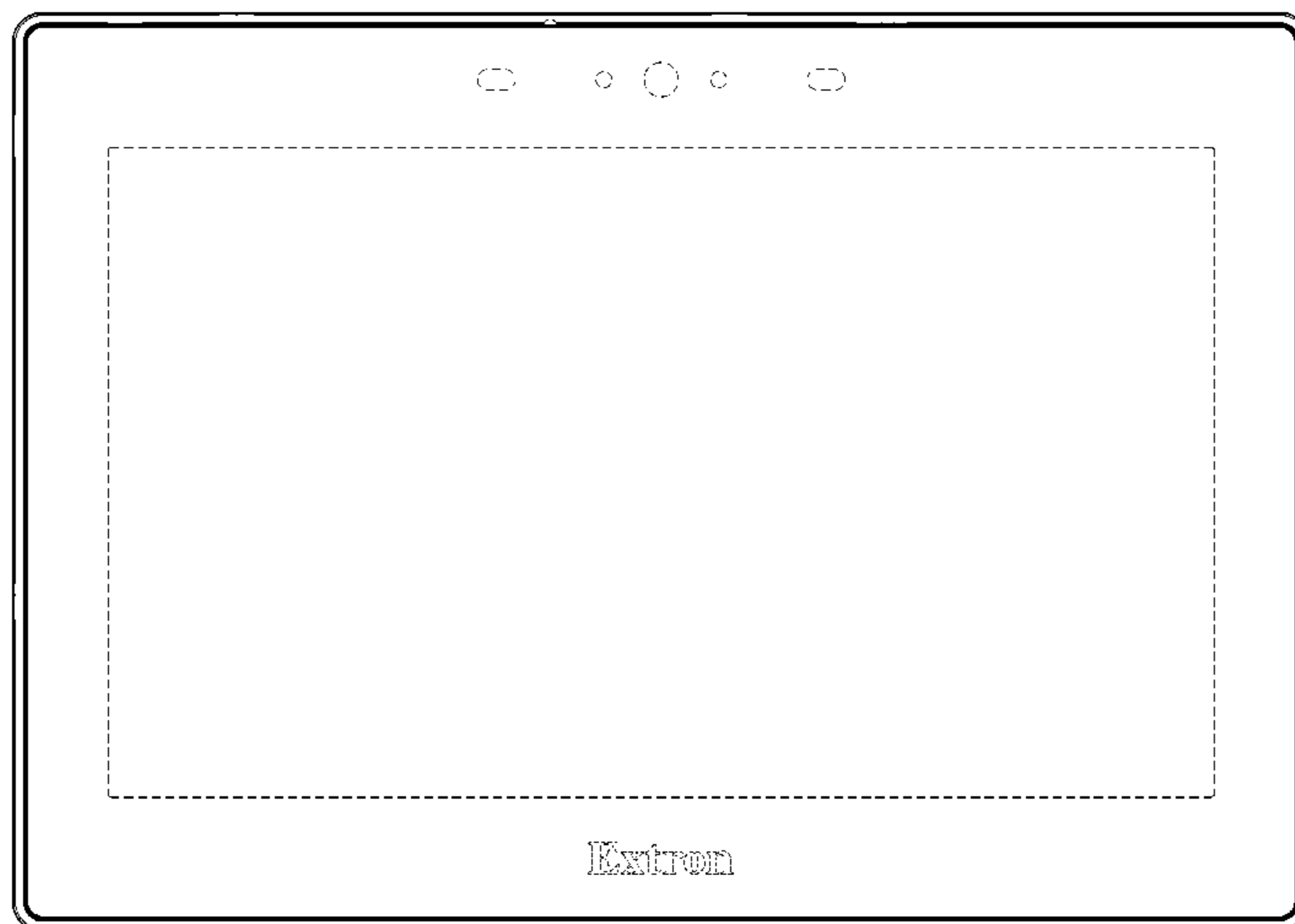

(56)

**References Cited**

U.S. PATENT DOCUMENTS

D811,383 S \* 2/2018 Diasabeygunawardena .....  
D14/336  
D811,384 S \* 2/2018 Diasabeygunawardena .....  
D14/336  
2015/0198973 A1\* 7/2015 Le ..... G06F 1/1601  
248/688

\* cited by examiner

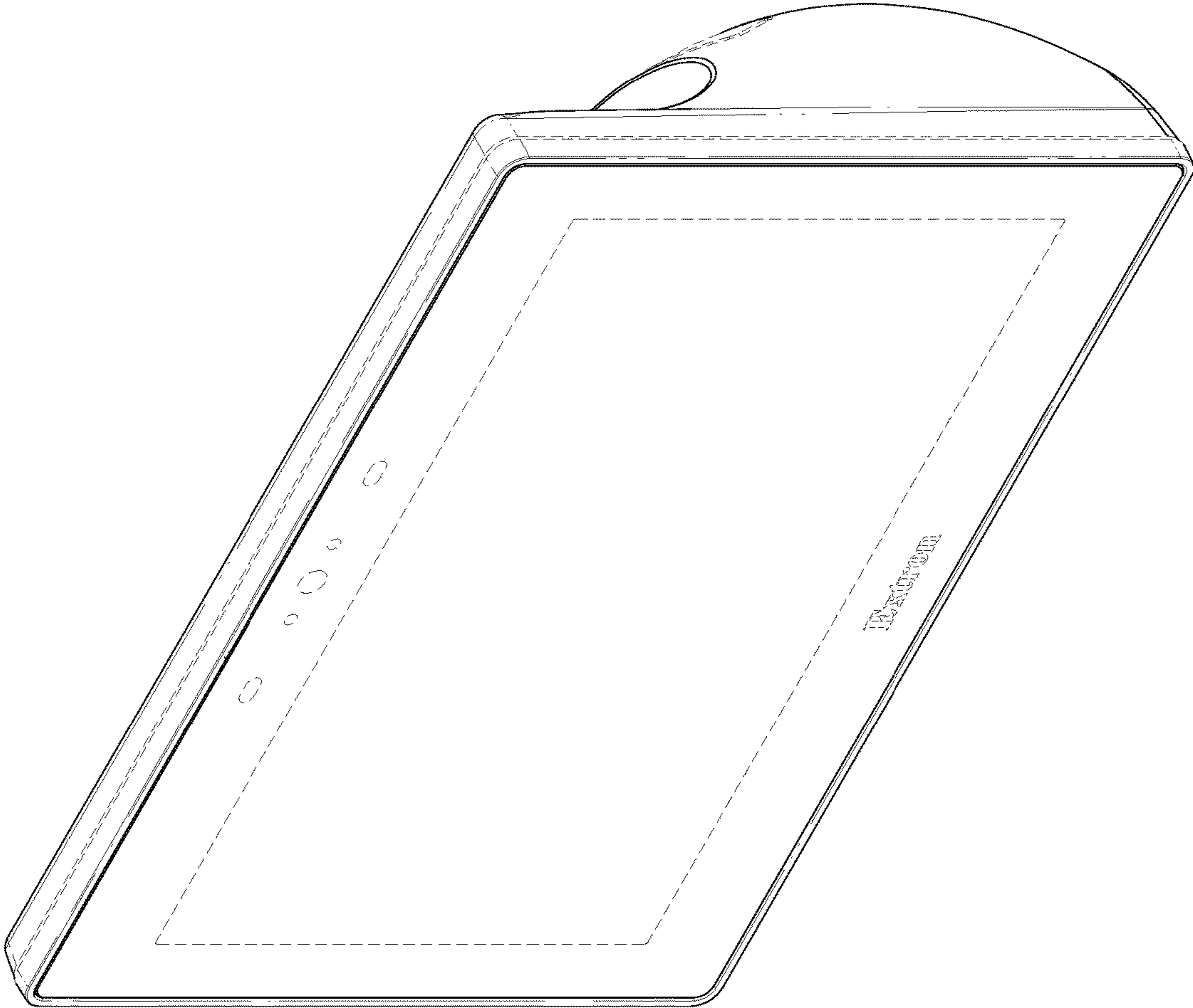

FIG. 1

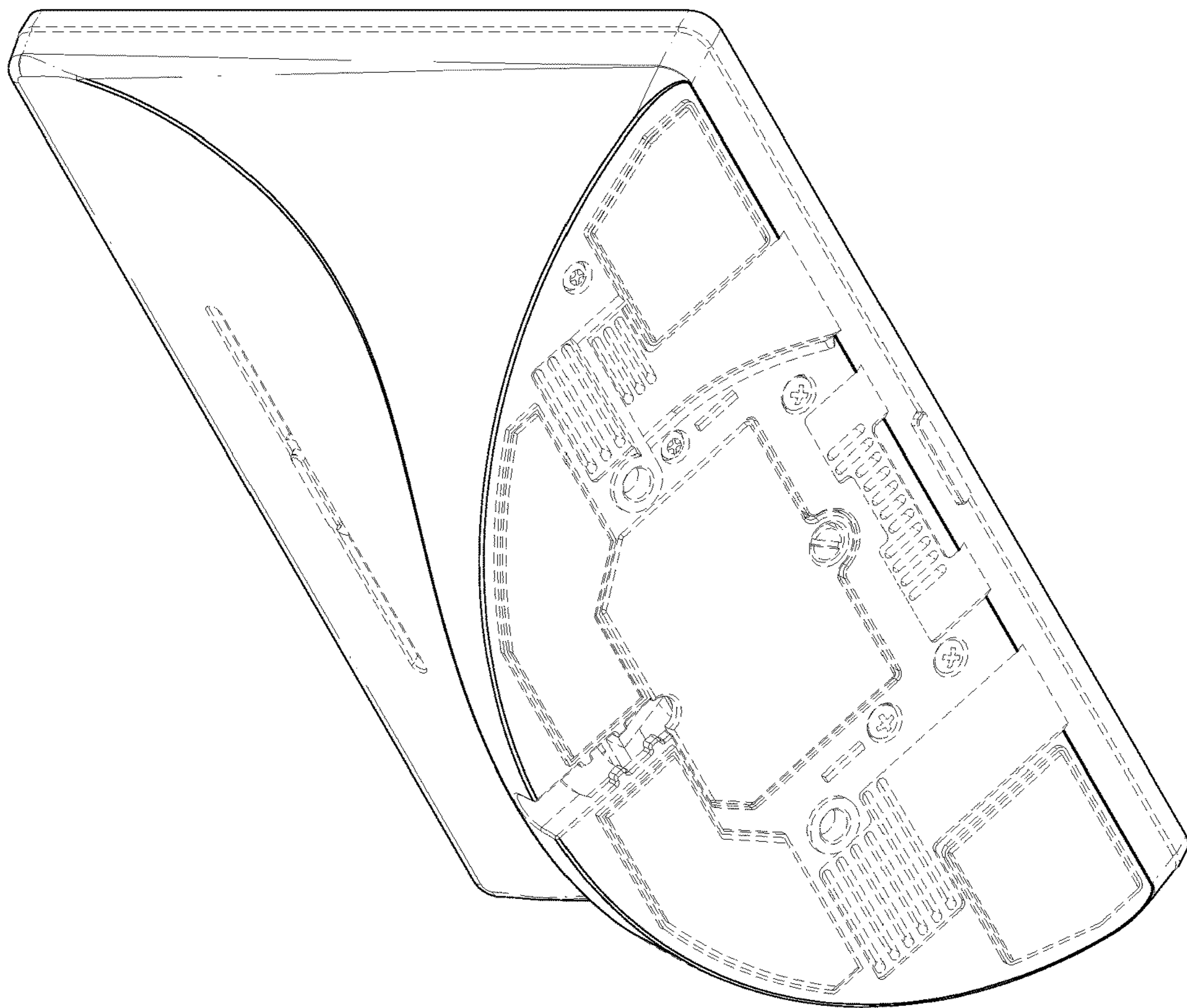

FIG. 2

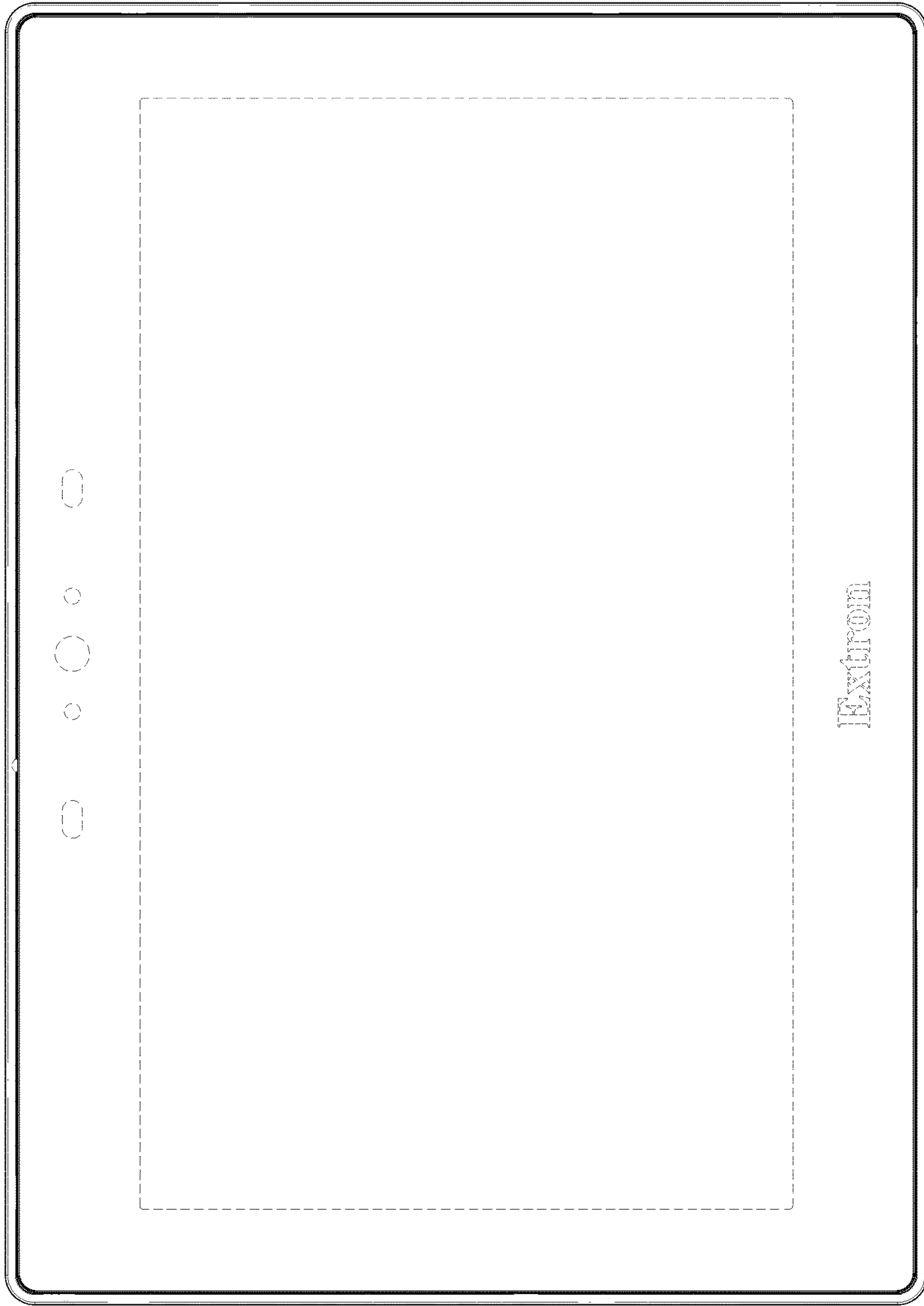

FIG. 3

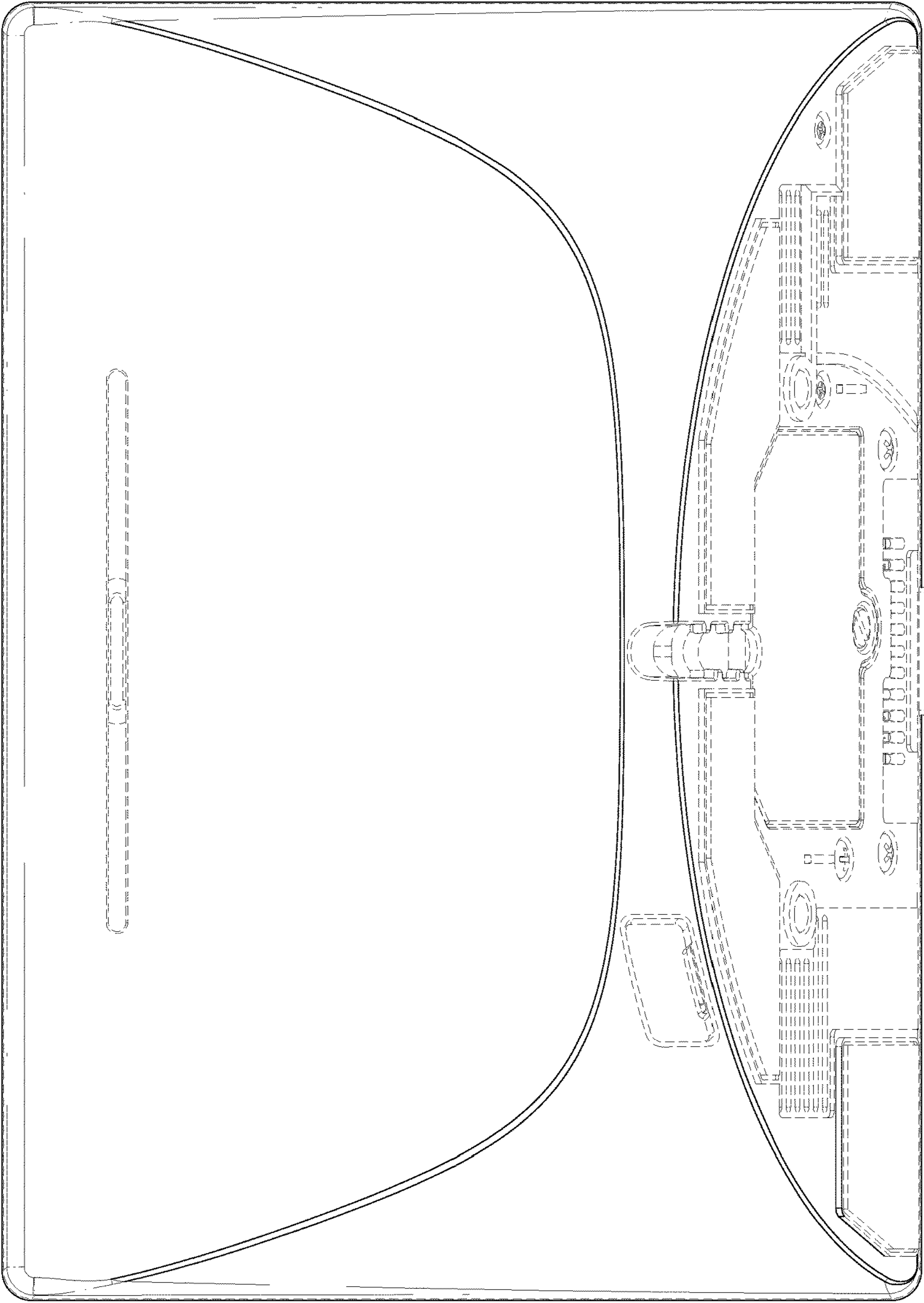

FIG. 4

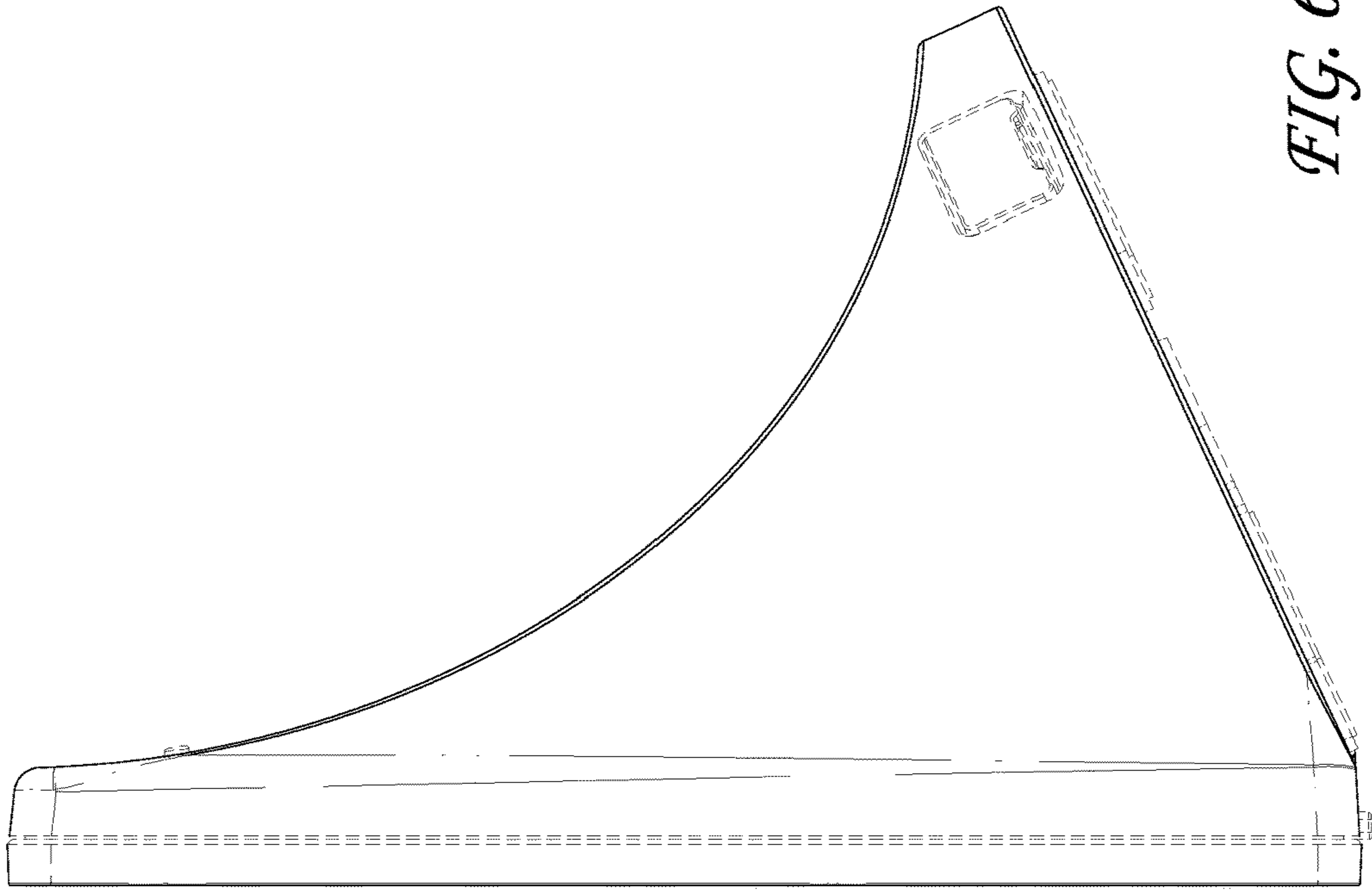

FIG. 6

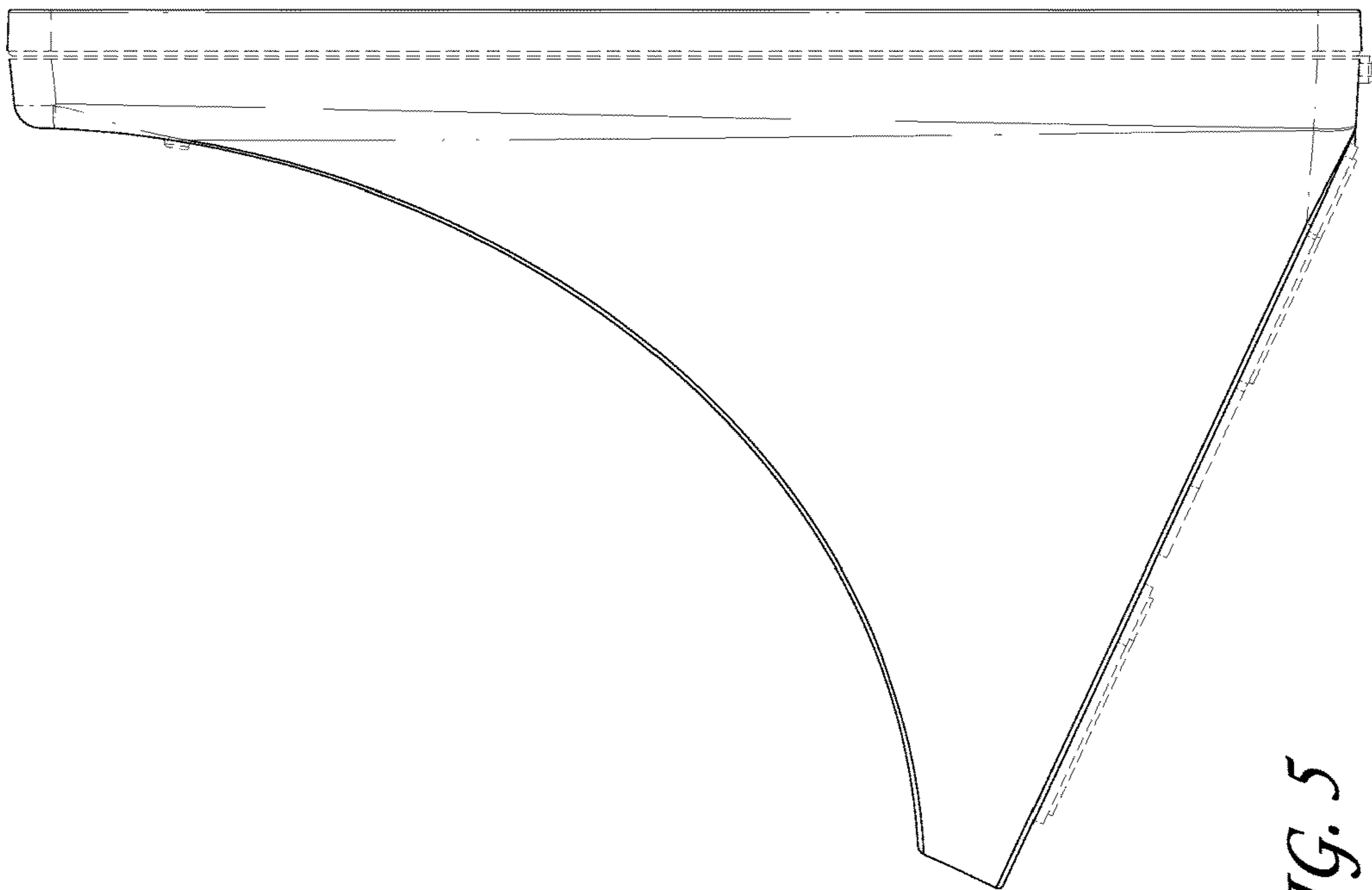

FIG. 5

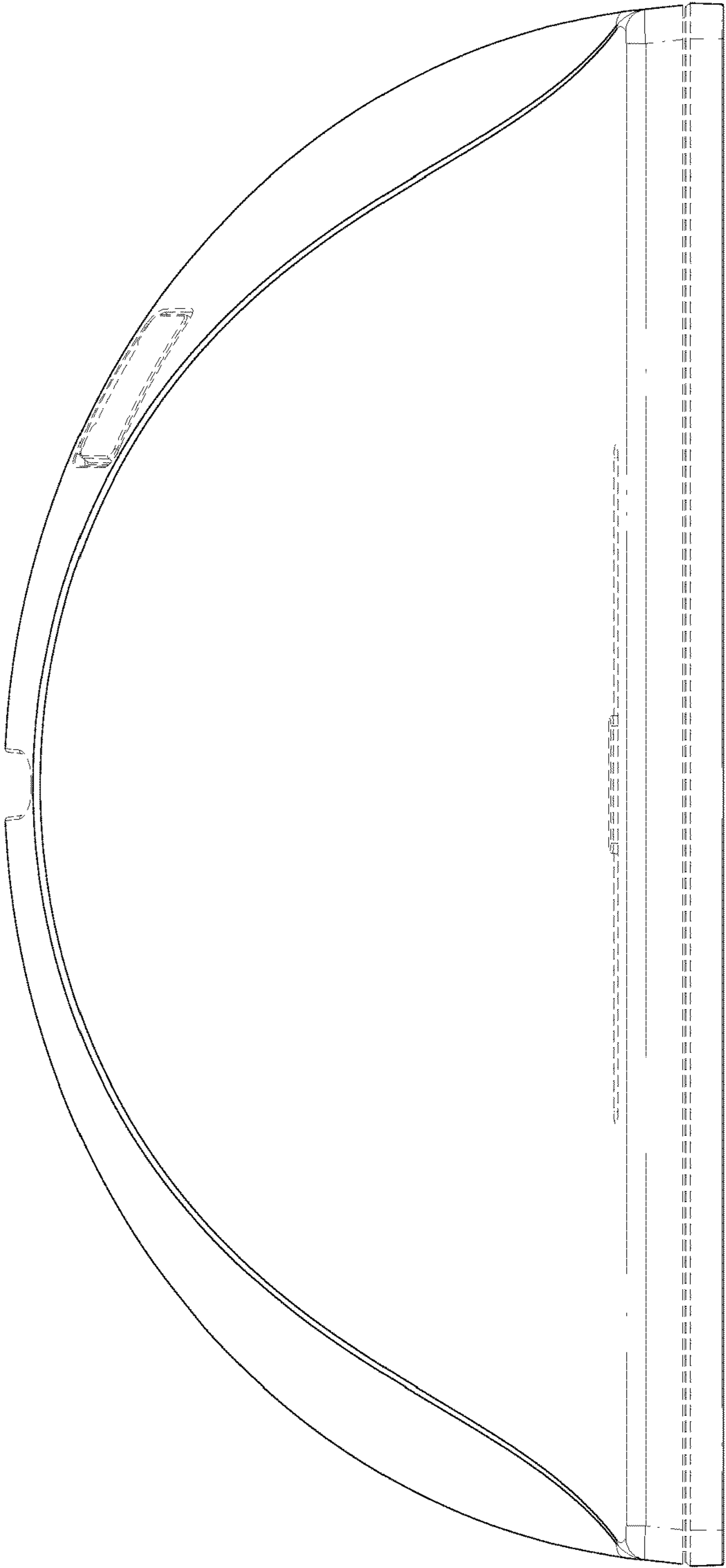

FIG. 7



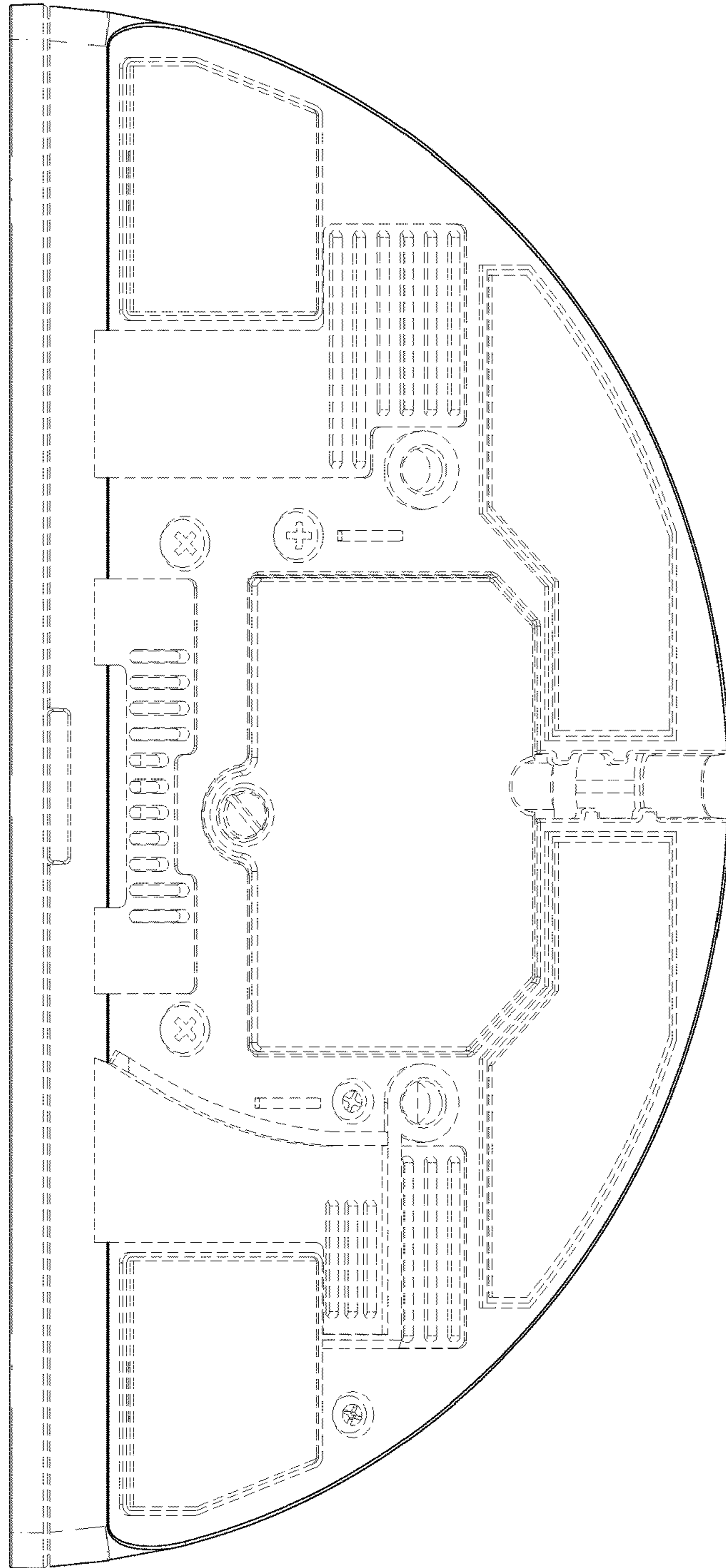

FIG. 8

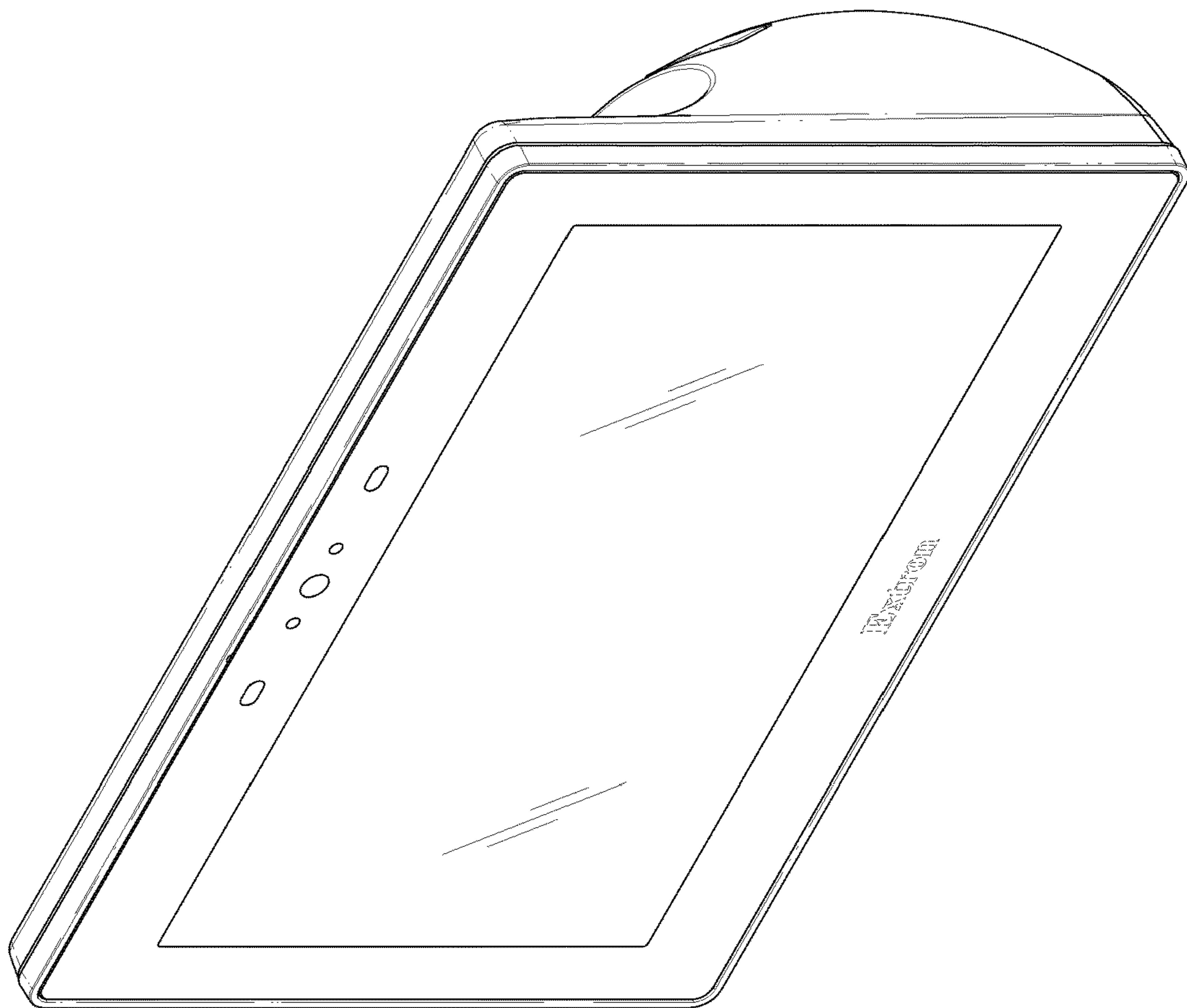
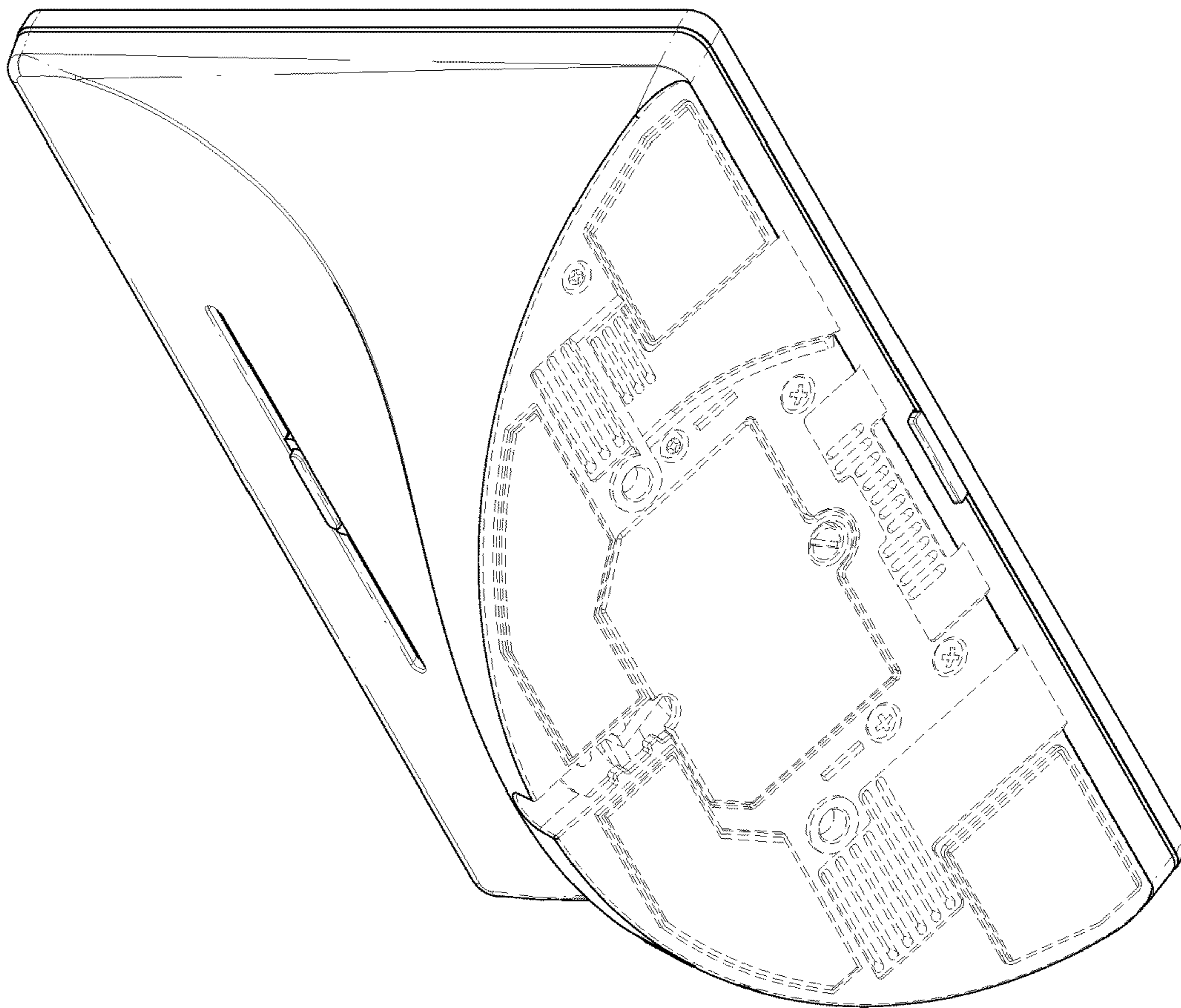

FIG. 9



*FIG. 10*

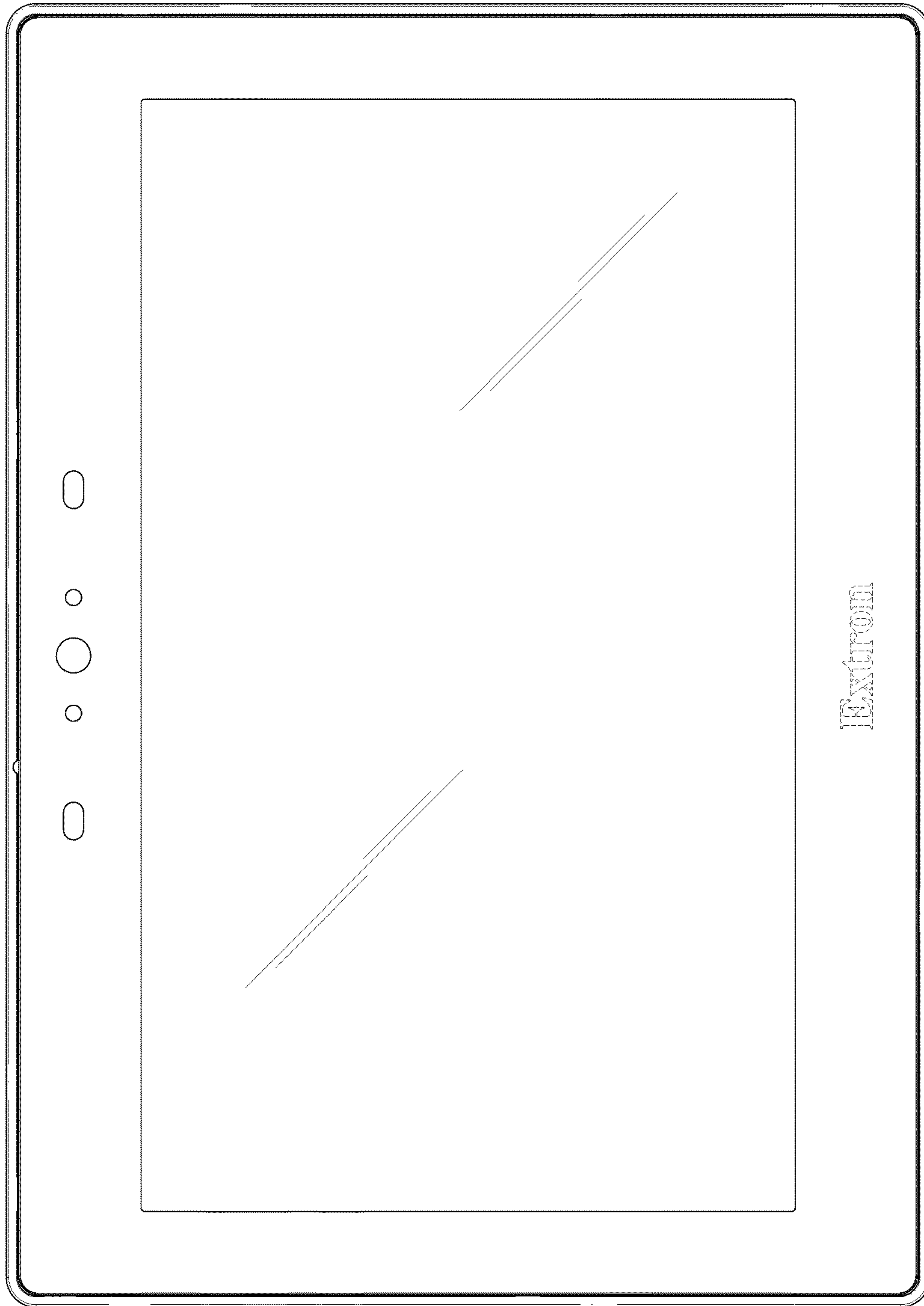

FIG. 11

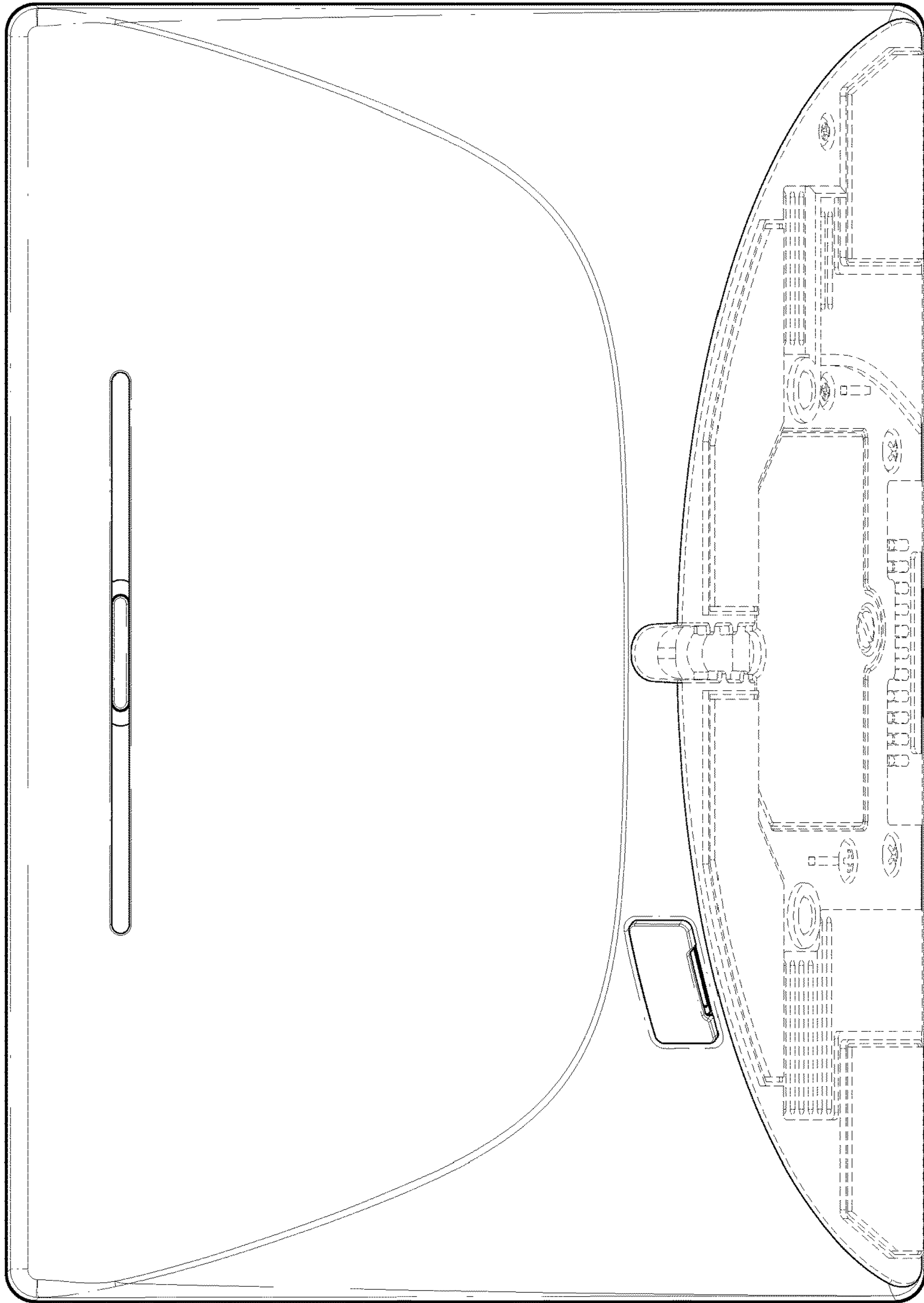

FIG. 12

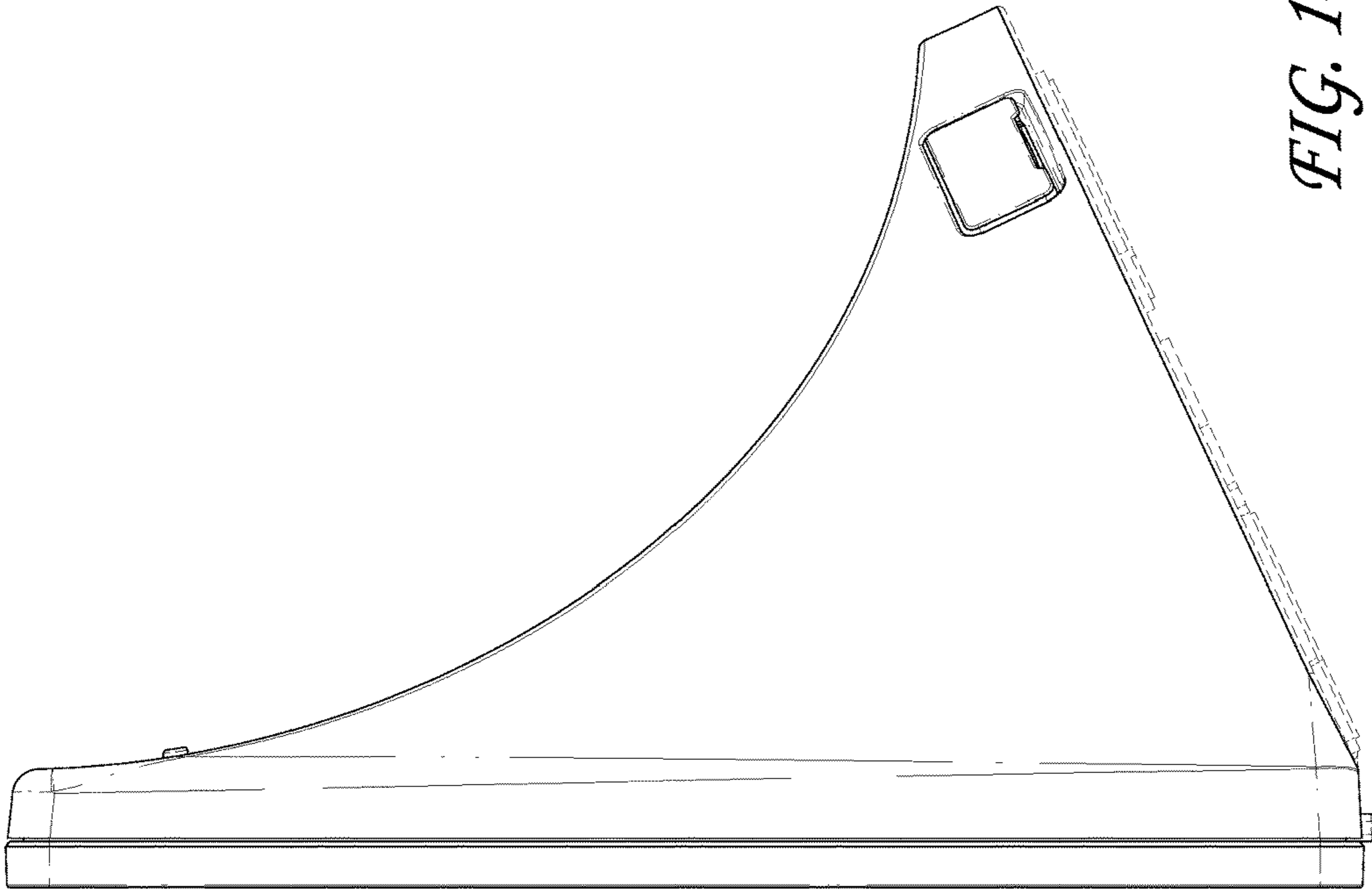

FIG. 14

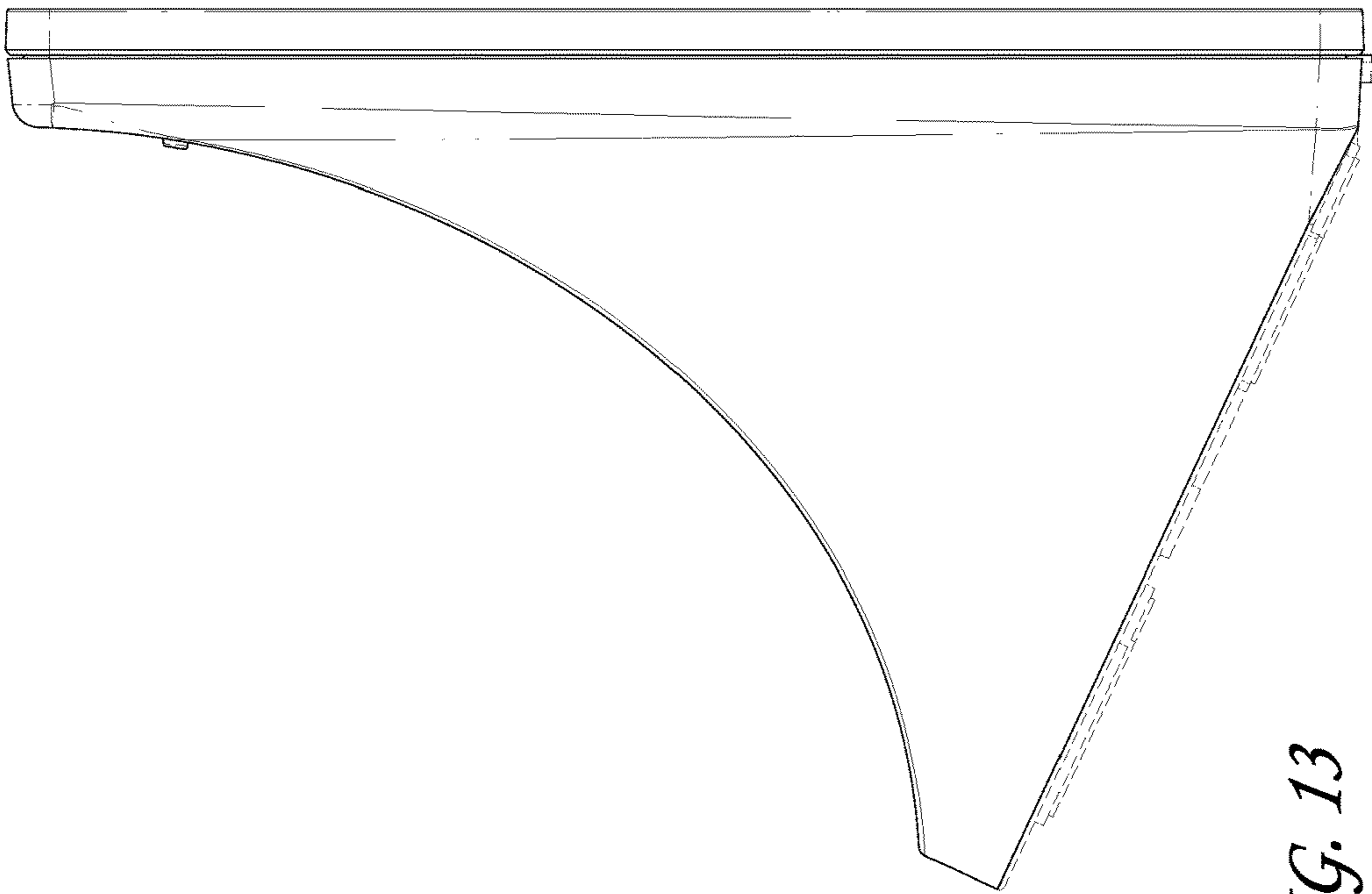

FIG. 13

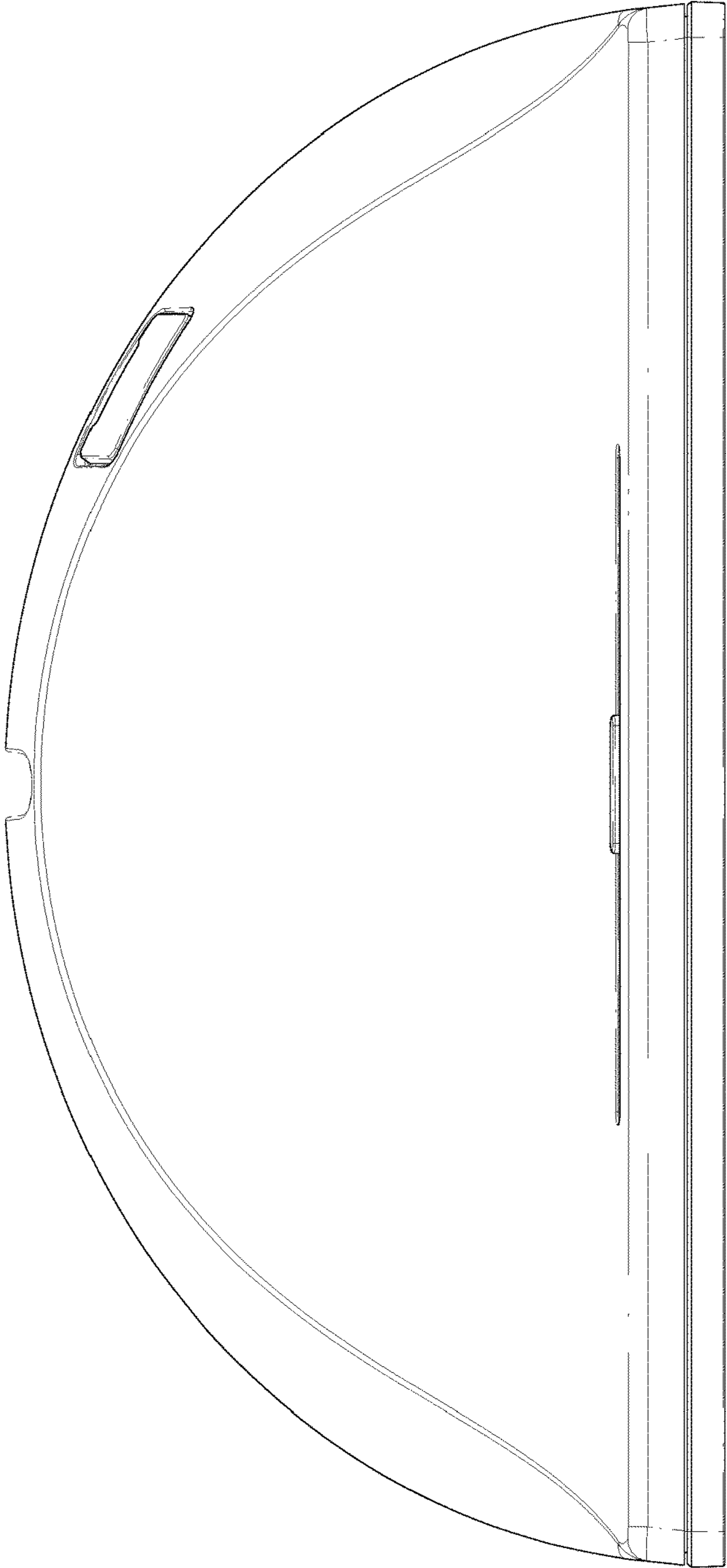

FIG. 15

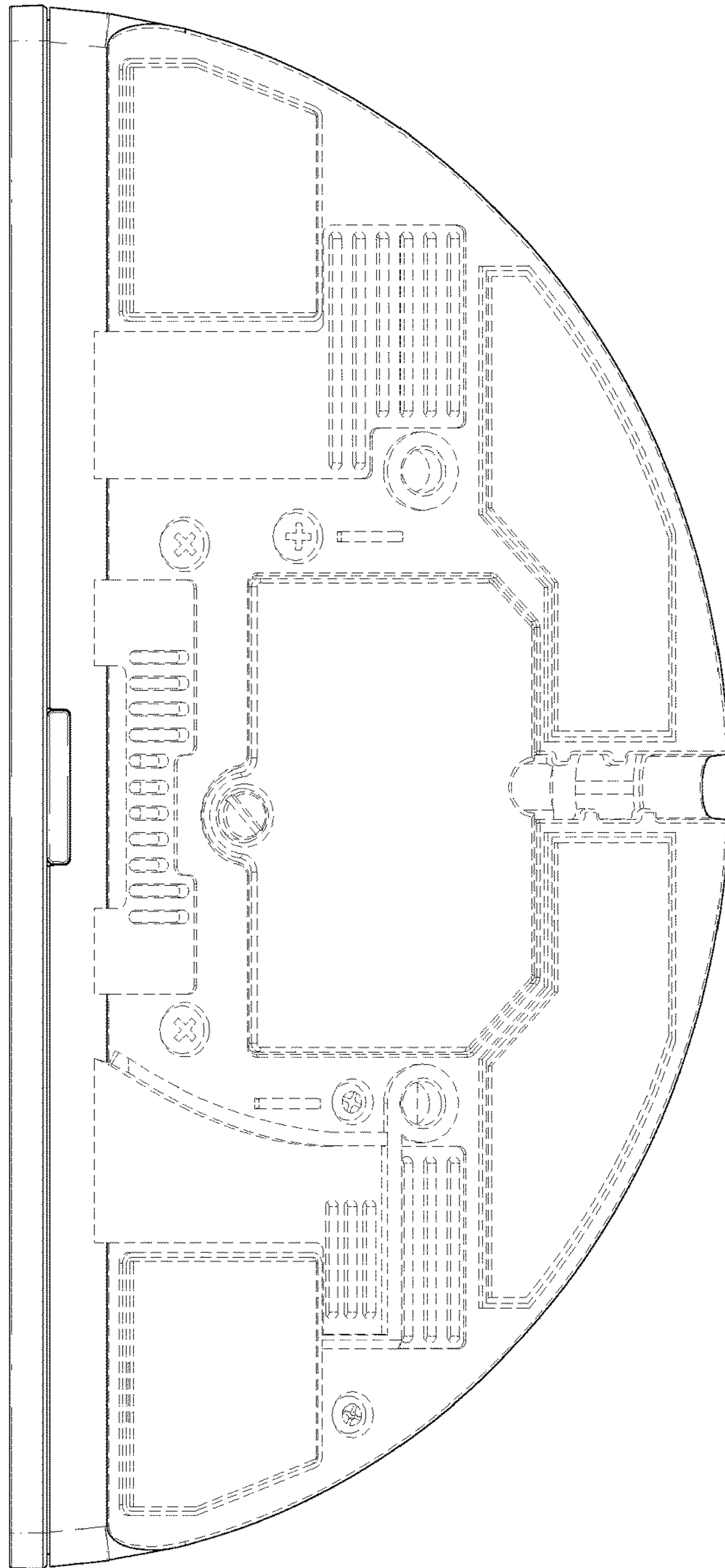

FIG. 16