



US00D850427S

(12) **United States Design Patent** (10) **Patent No.:** **US D850,427 S**
Hwang et al. (45) **Date of Patent:** **** Jun. 4, 2019**

(54) **STAND FOR TELEVISION RECEIVER**

11/04; F16M 11/043; F16M 11/10; F16M 13/00; H04M 1/04; H04M 1/06

(71) Applicant: **LG ELECTRONICS INC.**, Seoul (KR)

See application file for complete search history.

(72) Inventors: **Bodeung Hwang**, Seoul (KR); **Sangho Lee**, Seoul (KR); **Yongseok Kim**, Seoul (KR); **Junghyun Min**, Seoul (KR)

(56) **References Cited**

U.S. PATENT DOCUMENTS

D292,043 S * 9/1987 Billiet D6/300
D496,262 S * 9/2004 Dretzka D6/542
D530,952 S * 10/2006 Lord D6/542
D559,807 S * 1/2008 Fujii D14/126

(Continued)

(73) Assignee: **LG ELECTRONICS INC.**, Seoul (KR)

(**) Term: **15 Years**

FOREIGN PATENT DOCUMENTS

(21) Appl. No.: **35/504,309**

WO WO D095256-004 * 9/2017

(22) Filed: **Jul. 7, 2017**

Primary Examiner — Jeffrey D Asch

Assistant Examiner — Tracey J Bell

(80) **Hague Agreement Data**

Int. Filing Date: **Jul. 7, 2017**

Int. Reg. No.: **DM/096899**

Int. Reg. Date: **Jul. 7, 2017**

Int. Reg. Pub. Date: **Jan. 12, 2018**

(74) *Attorney, Agent, or Firm* — Birch, Stewart, Kolasch & Birch, LLP

(57) **CLAIM**

The ornamental design for a stand for television receiver, as shown and described.

(30) **Foreign Application Priority Data**

Jan. 9, 2017 (KR) 30-2017-0001171

(51) **LOC (11) Cl.** **14-03**

(52) **U.S. Cl.**
USPC **D14/239**

(58) **Field of Classification Search**
USPC D14/125–134, 239, 314–316, 322, 326, D14/334–336, 339–341, 371, 373–374, D14/448, 450, 214, 451, 251–253, 447, D14/434, 432, 439, 142, 217, 209–209.1, D14/229; D21/329, 322, 515; D6/300, D6/310, 314, 320, 322, 553, 525, 672, D6/407, 567, 701, 542; D8/349; D20/41, 42; D10/26
CPC G06F 1/16; G06F 1/1601; G06F 1/1637; G06F 1/1643; H04N 5/64; H05K 5/0204; H05K 5/0017; H05K 5/0217; H05K 5/0004; H05K 5/02; F16M 11/00; F16M

DESCRIPTION

1. Stand for television receiver

1.1 : Perspective

1.2 : Front

1.3 : Back

1.4 : Left

1.5 : Right

1.6 : Top

1.7 : Bottom

1.8 : Reference

The portions of the drawing disclosure shown in the color grey in Figures 1.1, 1.2, and 1.6 are for the purpose of illustrating portions of the stand for television receiver that form no part of the claimed design. The broken line showing

(Continued)

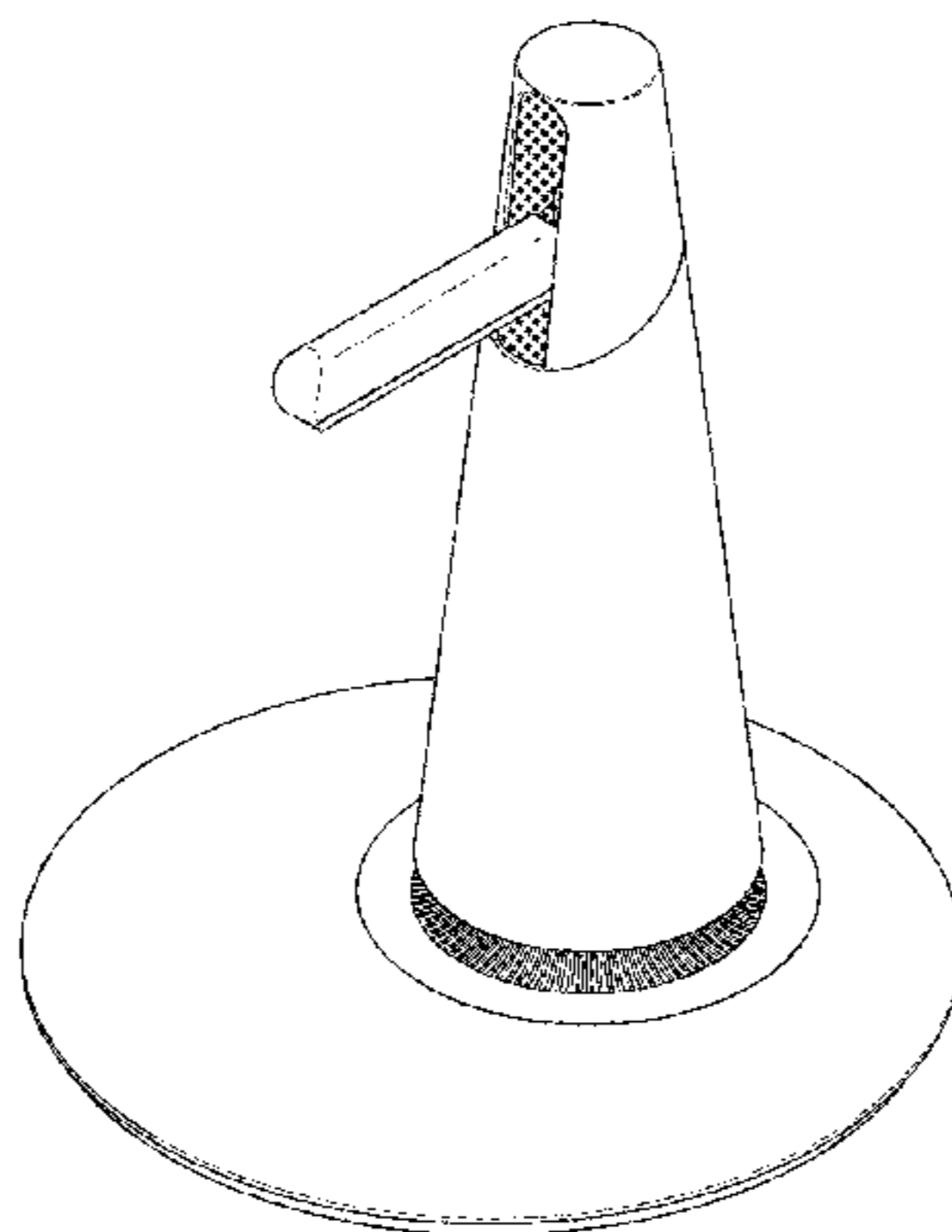

of a television receiver in Figure 1.8 is for the purpose of illustrating environmental structure and forms no part of the claimed design.

1 Claim, 5 Drawing Sheets

(56) **References Cited**

U.S. PATENT DOCUMENTS

D615,404 S *	5/2010	Pitzer	D9/500
D624,062 S *	9/2010	Kasuga	D14/239
D638,022 S *	5/2011	Kasuga	D14/239
D681,647 S *	5/2013	Choi	D14/451
D728,497 S *	5/2015	Jung	D14/126
9,392,715 B2 *	7/2016	Hwang	H05K 5/02
D819,615 S *	6/2018	Lee	D14/239
2013/0163163 A1 *	6/2013	Lee	H05K 7/00 361/679.01
2013/0292527 A1 *	11/2013	Mochizuki	F16M 11/10 248/161
2013/0335644 A1 *	12/2013	Horii	H04N 5/64 348/836
2013/0335897 A1 *	12/2013	Mochizuki	G06F 1/1601 361/679.01
2014/0043560 A1 *	2/2014	Jang	H05K 5/02 349/58

* cited by examiner

1.1

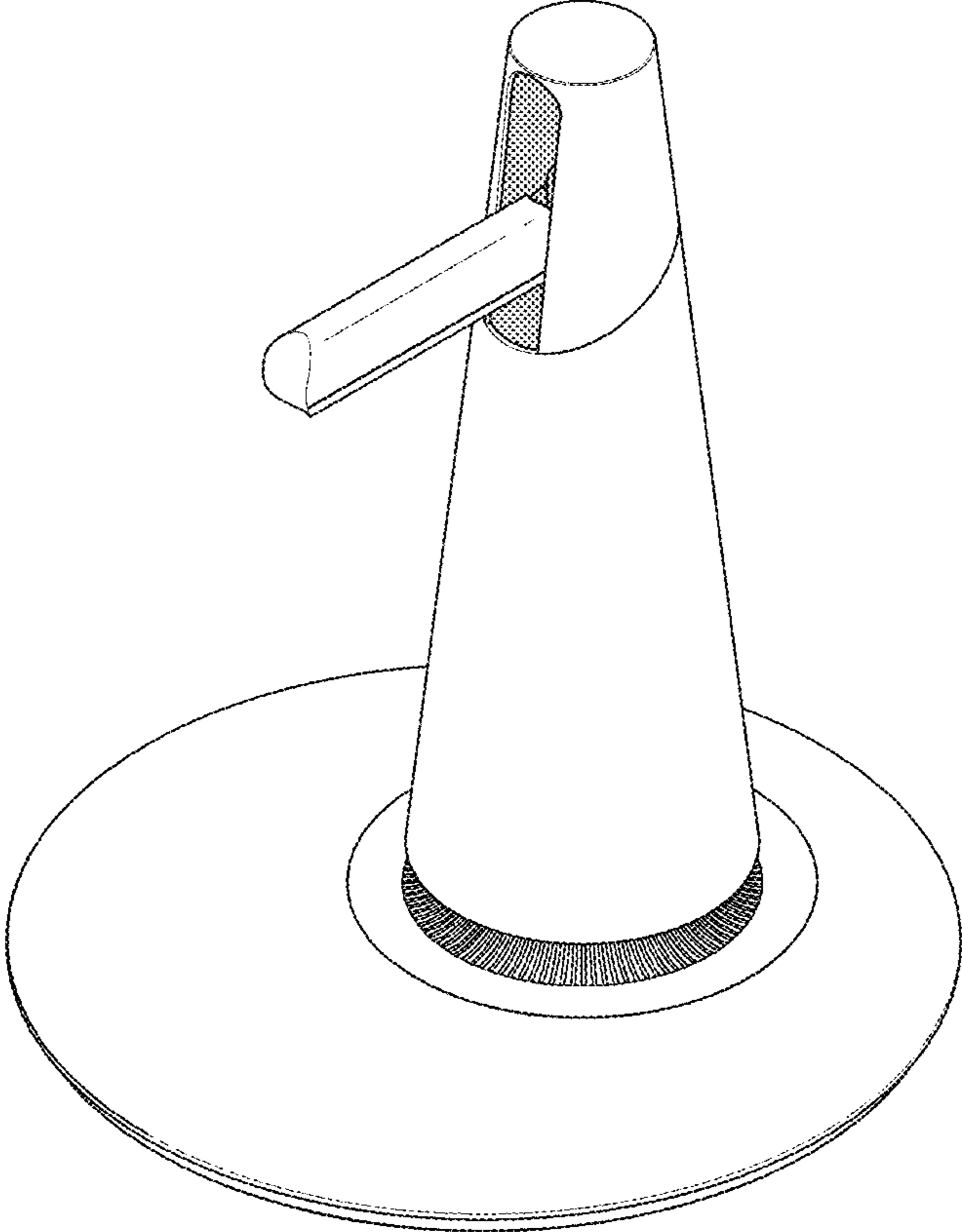

1.2

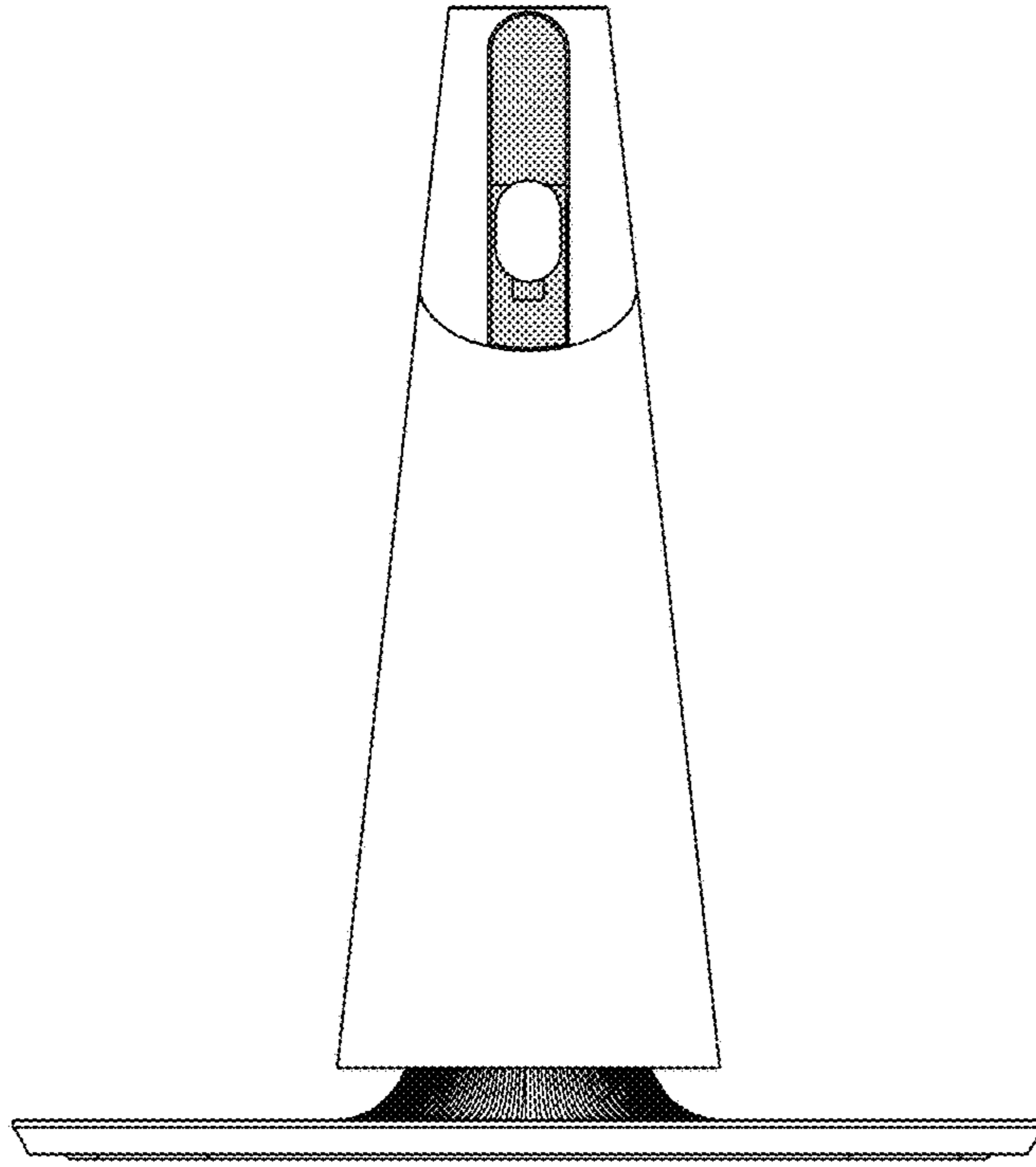

1.3

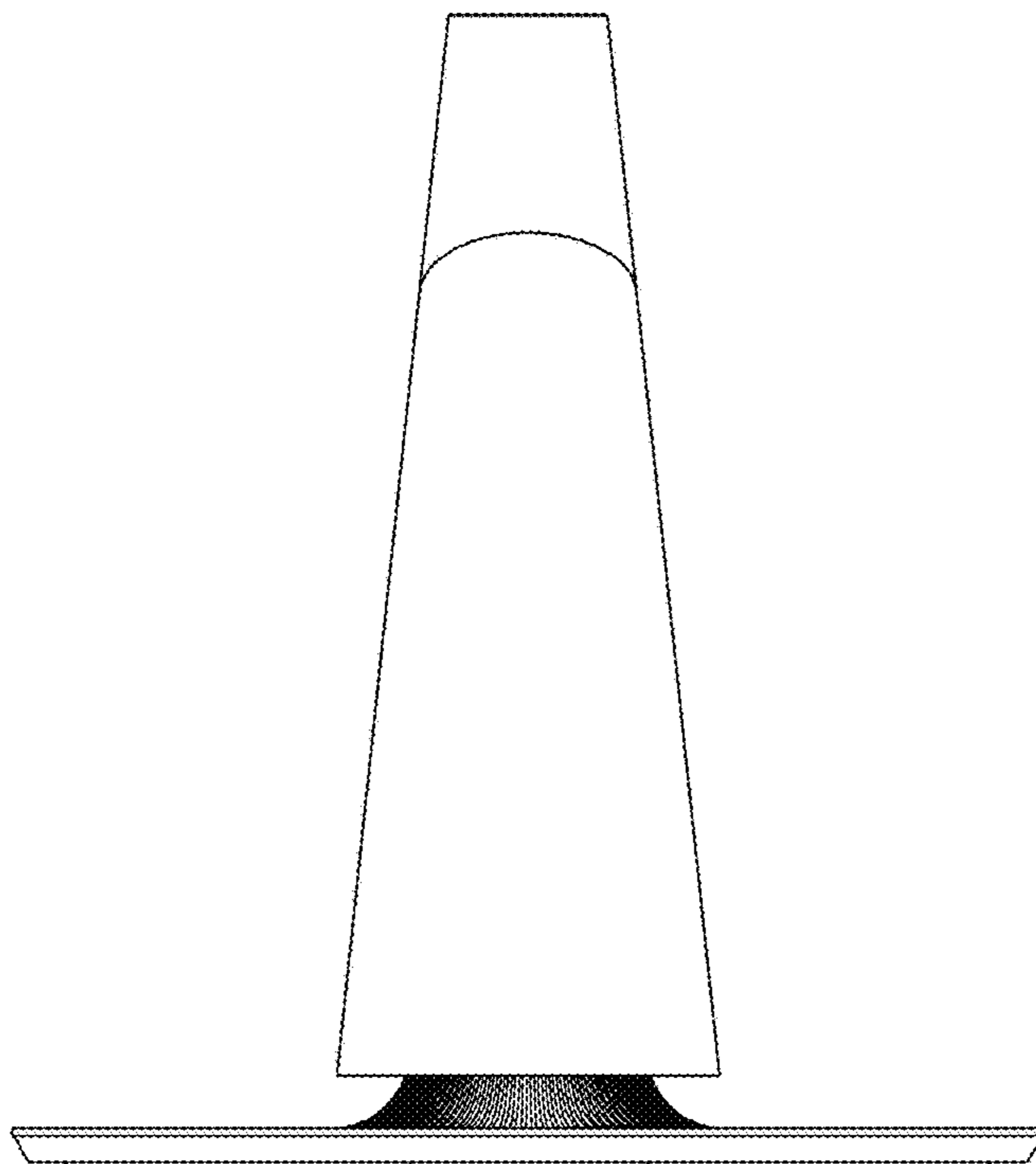

1.4

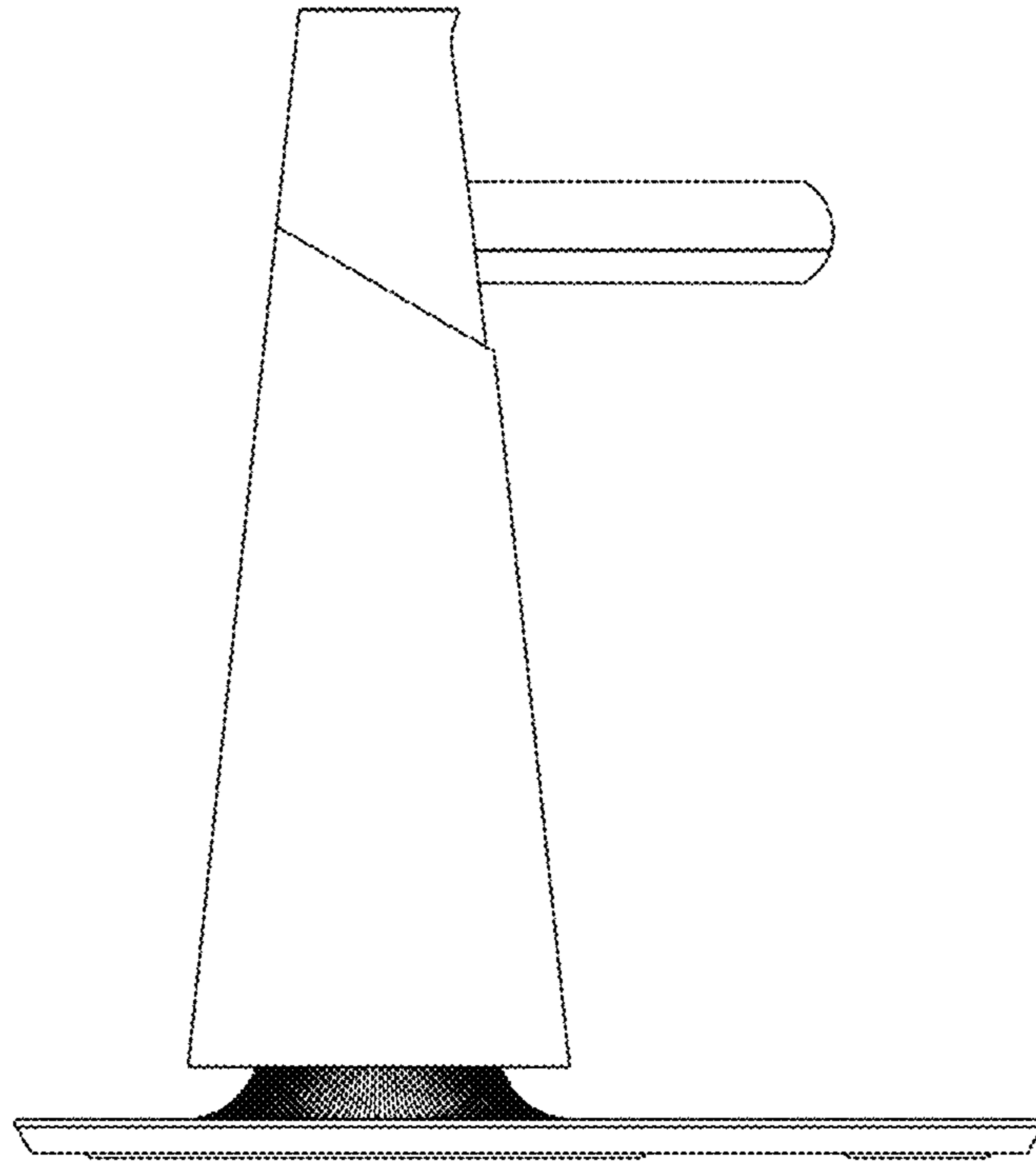

1.5

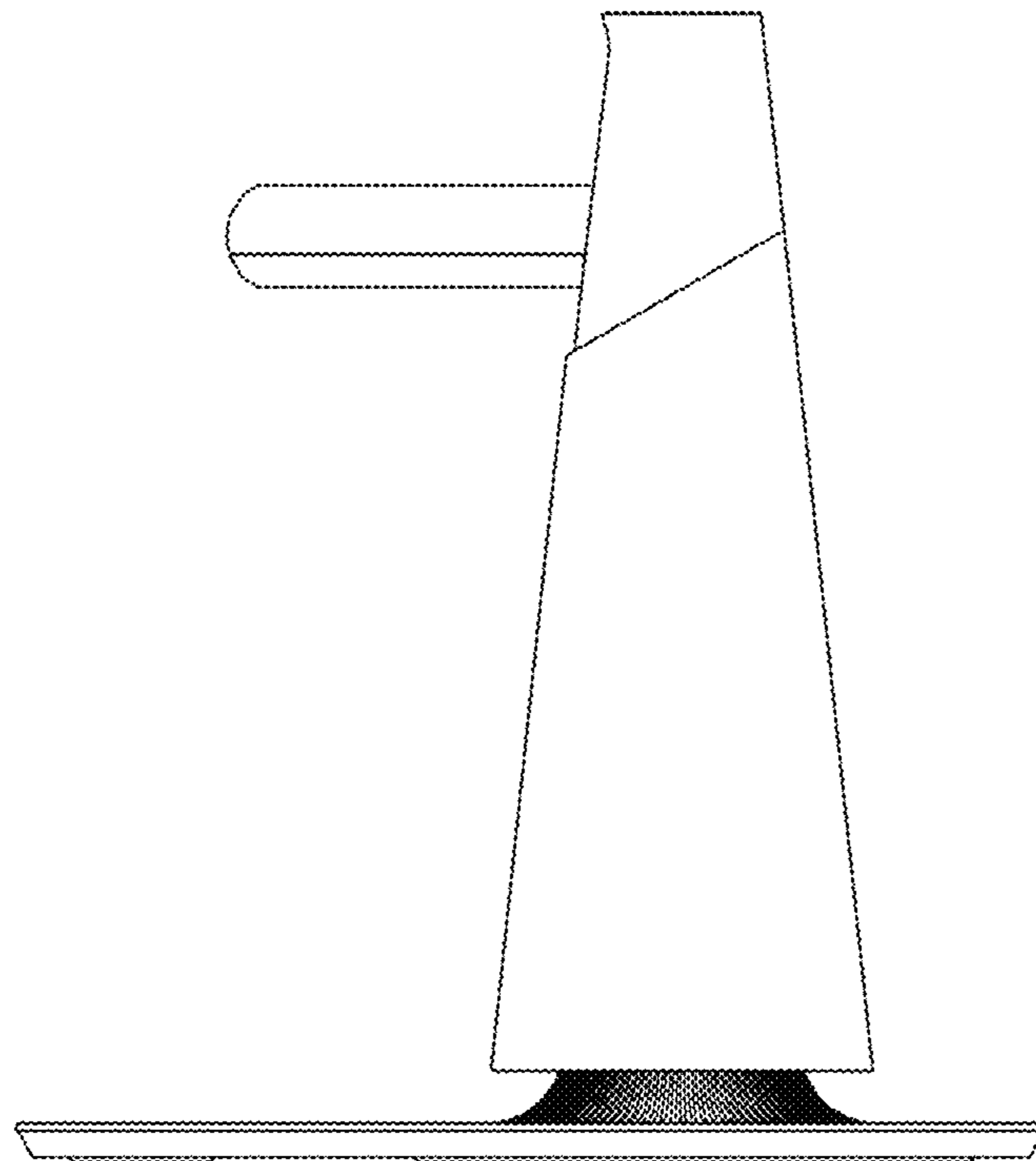

1.6

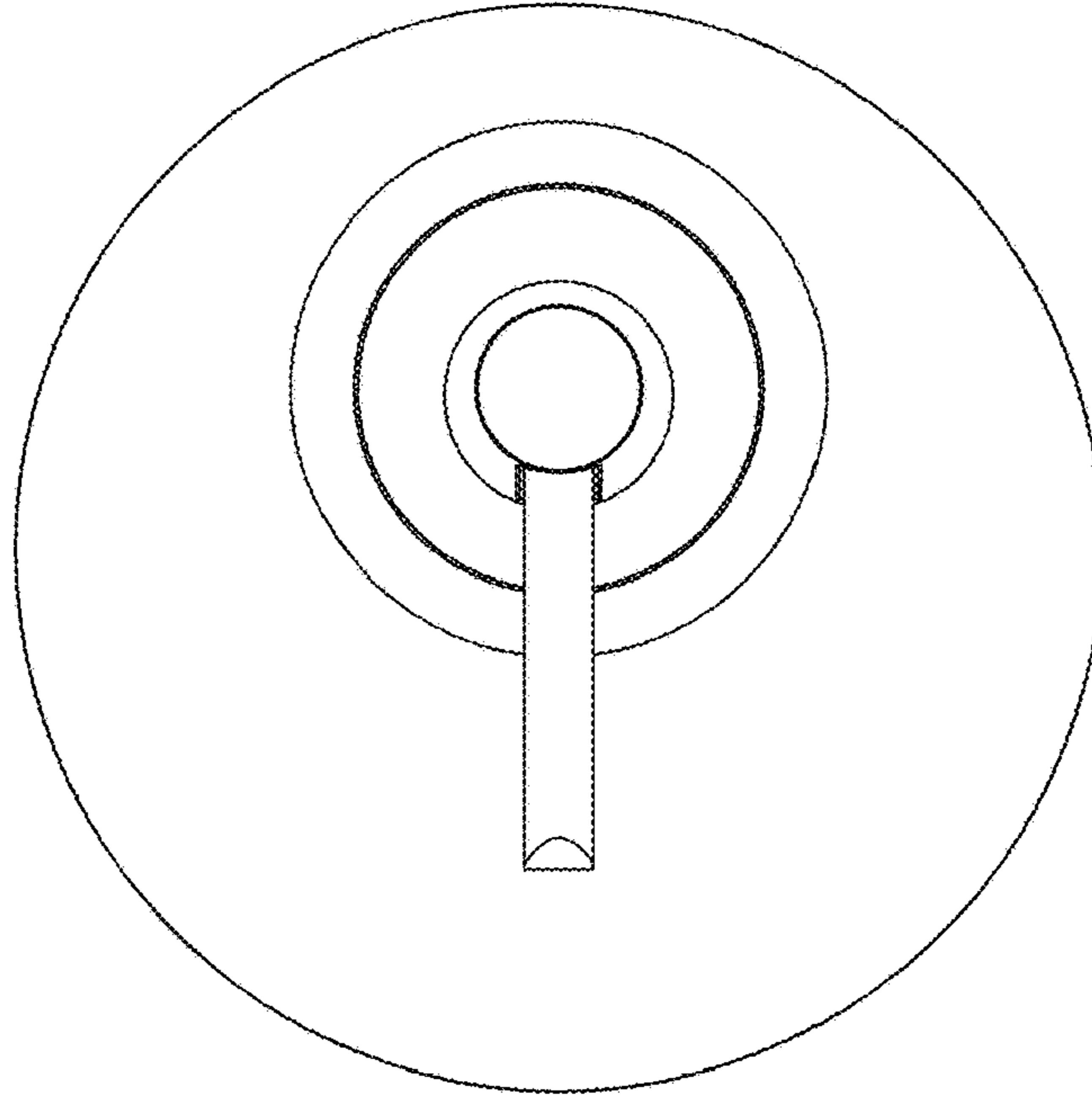

1.7

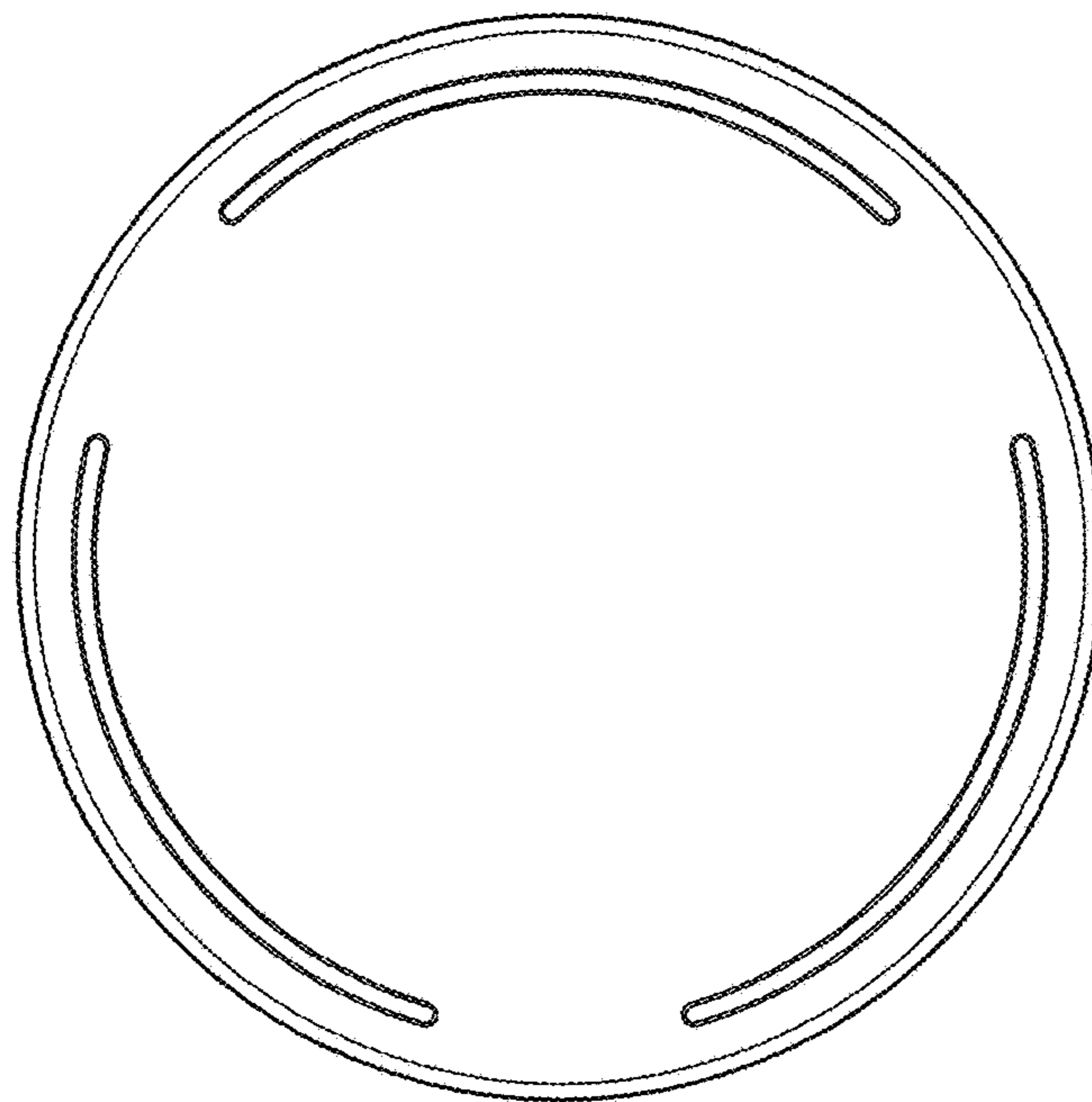

1.8

