



US00D850270S

(12) **United States Design Patent**  
**Berlepsch et al.**

(10) **Patent No.:** **US D850,270 S**  
(45) **Date of Patent:** **\*\* Jun. 4, 2019**

(54) **BOTTLE**

2501/00; B65D 2501/0009; B65D  
2501/0063; B65D 2501/0081

See application file for complete search history.

(71) Applicant: **The Procter & Gamble Company,**  
Cincinnati, OH (US)

(56) **References Cited**

U.S. PATENT DOCUMENTS

(72) Inventors: **Joseph Allen Berlepsch,** Hamilton, OH  
(US); **Jose Juan Fuentes, Jr.,** West  
Chester, OH (US); **Sigmund Jonathan**  
**Ausfresser,** Mason, OH (US); **James**  
**Christopher Dorn,** Sterling, OH (US);  
**Paris Alexander Lowitz,** San  
Francisco, CA (US)

D451,397 S \* 12/2001 Gerhart ..... D9/527  
6,435,382 B1 \* 8/2002 Giblin ..... B65D 1/40  
222/509  
D470,054 S 2/2003 Gerhart et al.  
6,523,724 B2 \* 2/2003 Paulovich ..... B65D 51/1616  
215/261

(Continued)

OTHER PUBLICATIONS

(73) Assignee: **The Procter & Gamble Company,**  
Cincinnati, OH (US)

U.S. Appl. No. 29/627,852, filed Nov. 30, 2017, Signe Christina  
Luebbers.

(Continued)

(\*\*) Term: **15 Years**

*Primary Examiner* — Dana Meyrow

(74) *Attorney, Agent, or Firm* — Andres E. Velarde;  
Gregory S. Darley-Emerson

(21) Appl. No.: **29/627,851**

(57) **CLAIM**

The ornamental design for a bottle, as shown and described.

(22) Filed: **Nov. 30, 2017**

(51) **LOC (11) Cl.** ..... **09-01**

(52) **U.S. Cl.**

USPC ..... **D9/524; D9/528; D9/563; D9/565;**  
D9/571

(58) **Field of Classification Search**

USPC ..... D9/516, 523–524, 526–528, 530–531,  
D9/543, 563, 571, 575, 715, 719, 738,  
D9/741–742; D23/211.1, 225; D32/75  
CPC ..... B65D 1/00; B65D 1/02; B65D 1/0223;  
B65D 1/18; B65D 23/00; B65D 23/10;  
B65D 23/102; B65D 41/26; B65D

**DESCRIPTION**

FIG. 1 is a front perspective view of an embodiment of a  
bottle embodying our new design;  
FIG. 2 is a front view of the bottle;  
FIG. 3 is a left view of the bottle;  
FIG. 4 is a back view of the bottle;  
FIG. 5 is a right view of the bottle;  
FIG. 6 is a top view of the bottle;  
FIG. 7 is a bottom view of the bottle;  
FIG. 8 is a front perspective view of a second embodiment  
of a bottle embodying our new design;  
FIG. 9 is a front view of the bottle;  
FIG. 10 is a left view of the bottle;  
FIG. 11 is a back view of the bottle;  
FIG. 12 is a right view of the bottle;

(Continued)

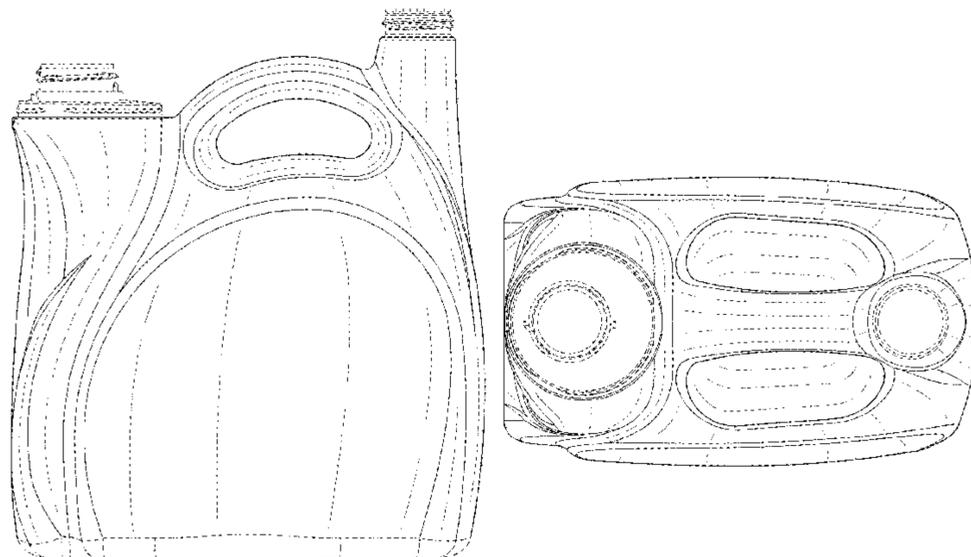

FIG. 13 is a top view of the bottle; and, FIG. 14 is a bottom view of the bottle. The bottles of the present disclosure may be suitable for containing and/or dispensing surface care compositions, such as fabric care compositions. The broken lines in the drawings illustrate the portions of the bottle that form no part of the claimed design.

1 Claim, 12 Drawing Sheets

D576,882 S *	9/2008	Meeker .....	D9/516
D581,277 S	11/2008	Horstman et al.	
D608,206 S	1/2010	Kopulos et al.	
D613,169 S	4/2010	Lee et al.	
D627,231 S	11/2010	Lee et al.	
D643,297 S	8/2011	Lee et al.	
D650,685 S *	12/2011	Weaver .....	D9/524
D695,120 S	12/2013	Maas et al.	
2006/0138180 A1 *	6/2006	Giblin .....	B65D 41/26 222/570

(56)

References Cited

U.S. PATENT DOCUMENTS

D543,465 S	5/2007	Meeker et al.	
D543,855 S	6/2007	Cardinal et al.	
D550,090 S	9/2007	Meeker et al.	
D550,559 S	9/2007	Meeker et al.	
7,357,266 B2 *	4/2008	Giblin .....	B65D 25/42 215/261

OTHER PUBLICATIONS

GNPD-Picture of Sun Bottle, one picture of Kirkland Bottle ,dated Nov. 12, 2018.  
Picture of Seventh Generation Natural Laundry Detergent Free & Clear—150 fl oz, www.vitacost.com, from website on Nov. 14, 2018.  
Picture of Kirkland Signature Ultra Clean Premium Laundry Detergent 133 Wash Loads, www.Costco.com, from website on Nov. 14, 2018.

\* cited by examiner

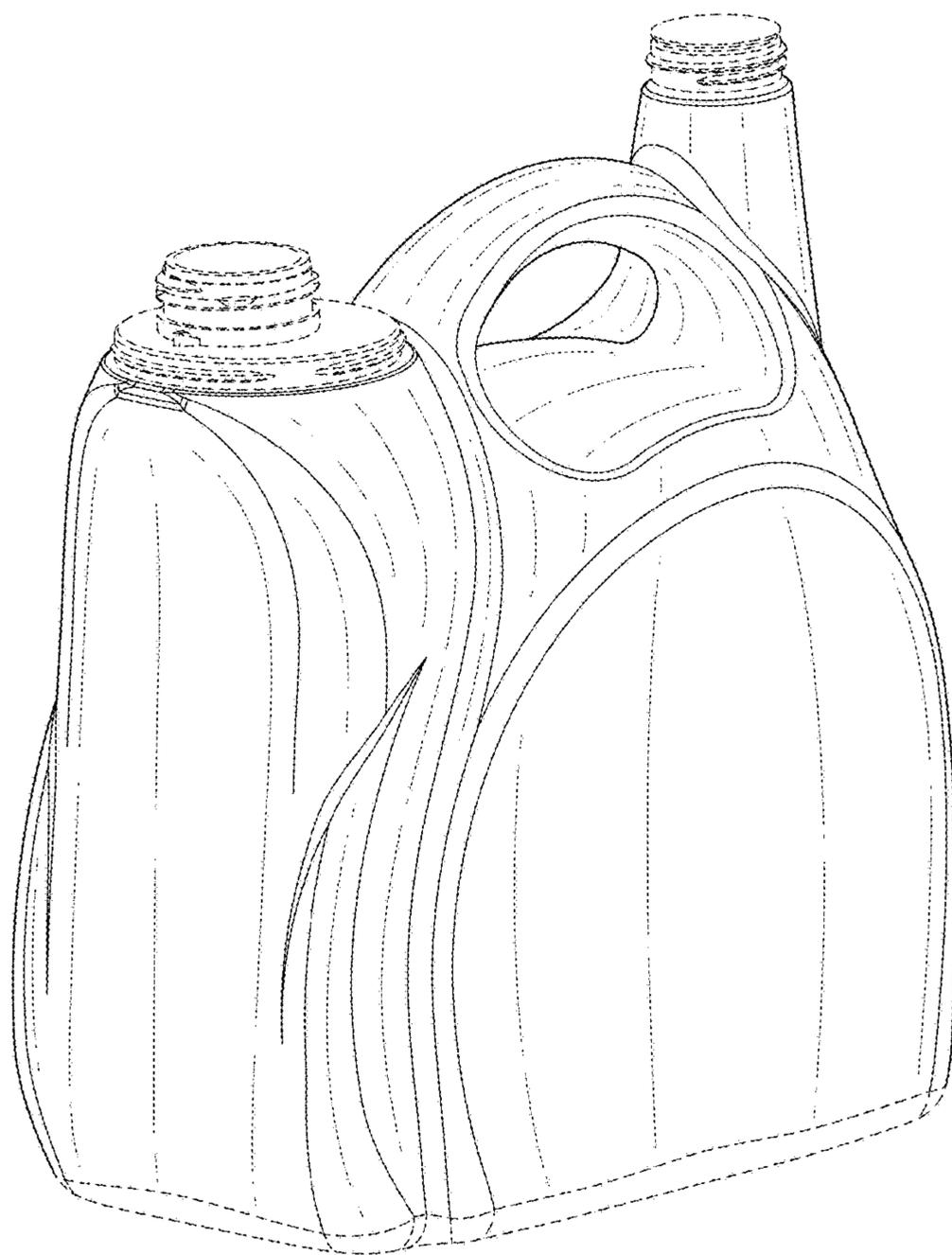

FIG. 1

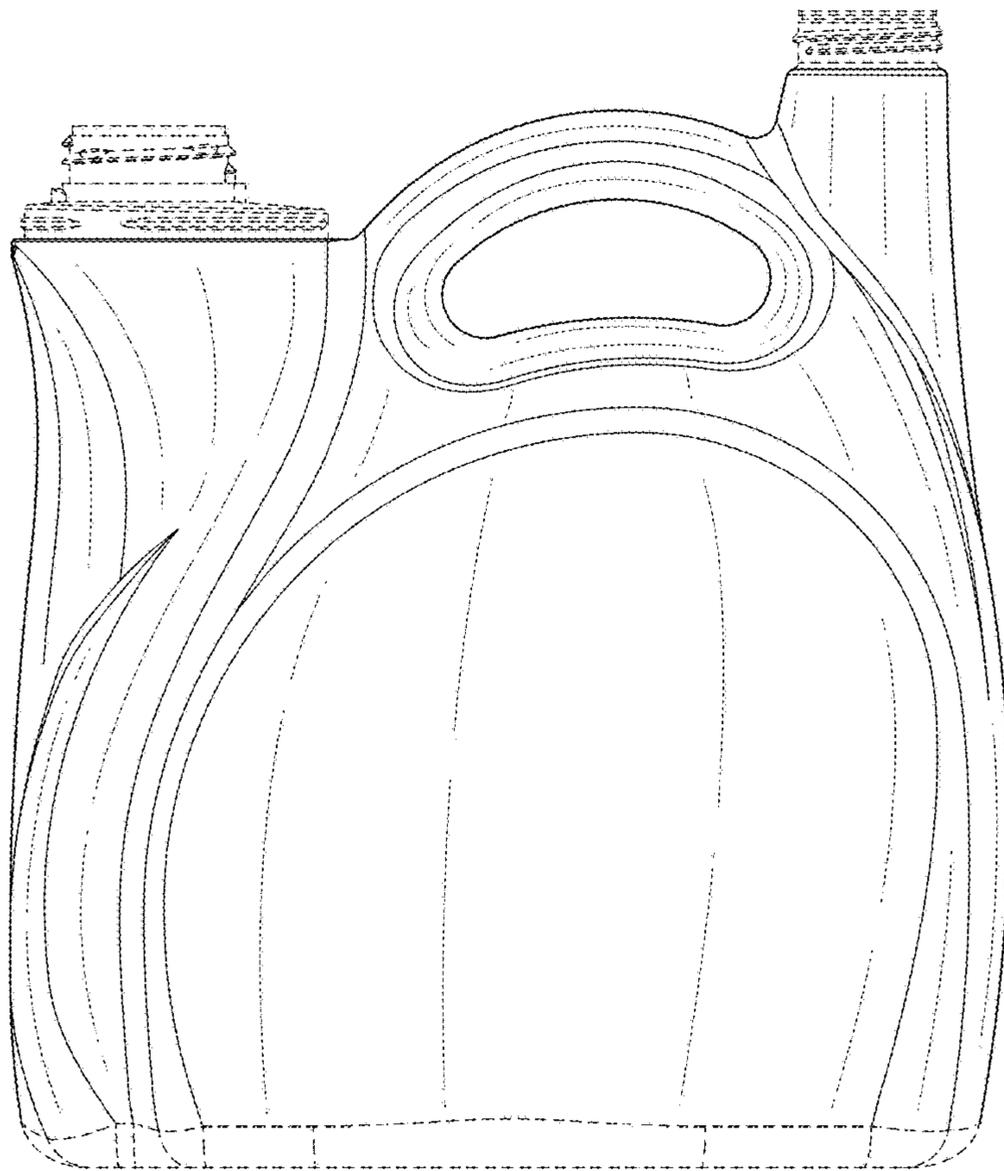

FIG. 2

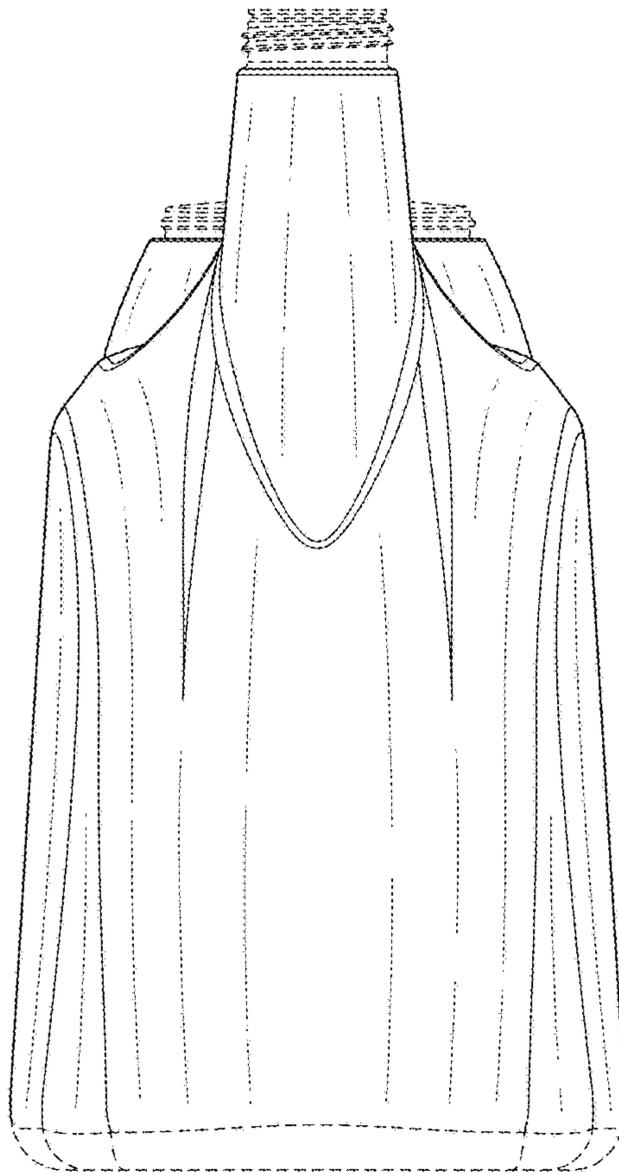

FIG. 3

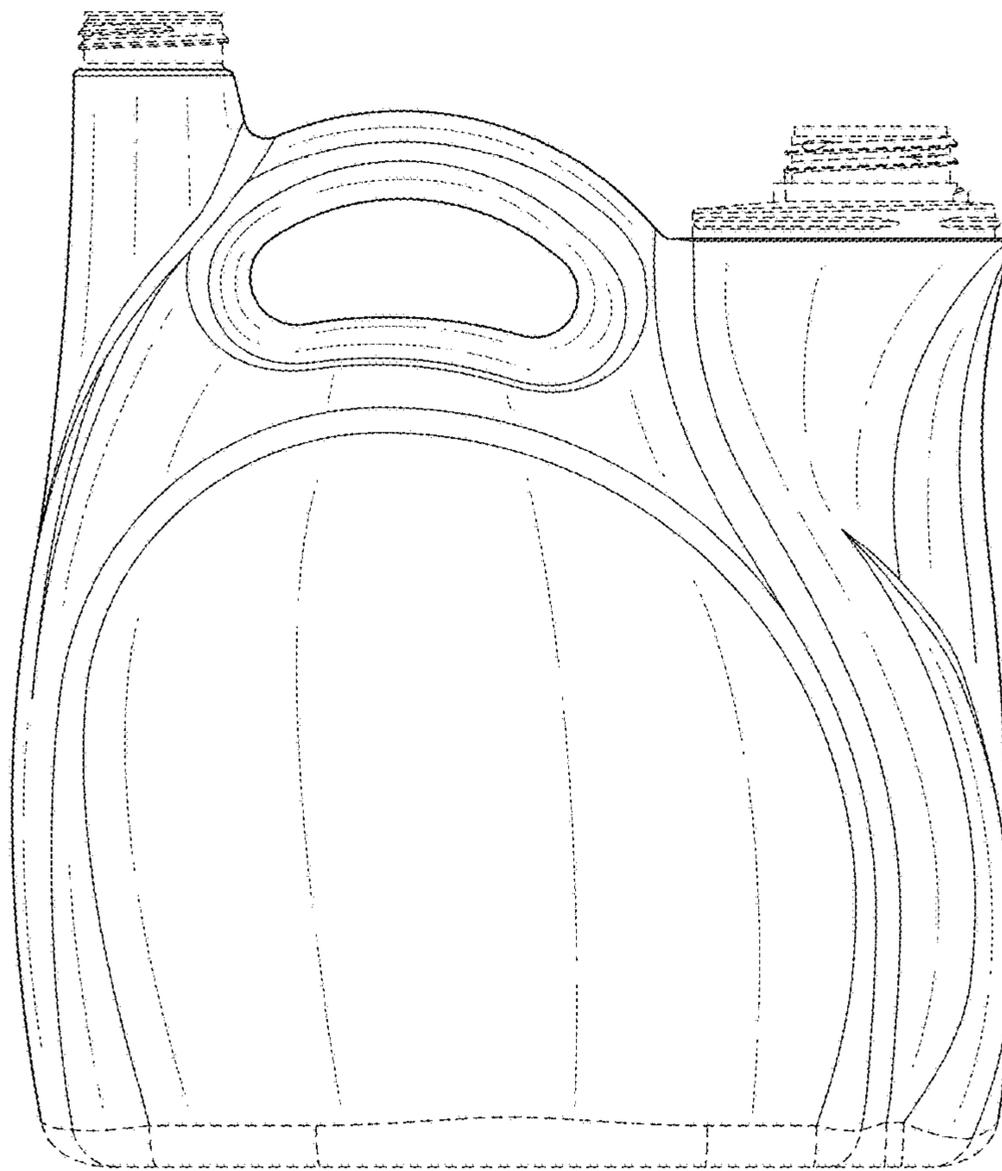

FIG. 4

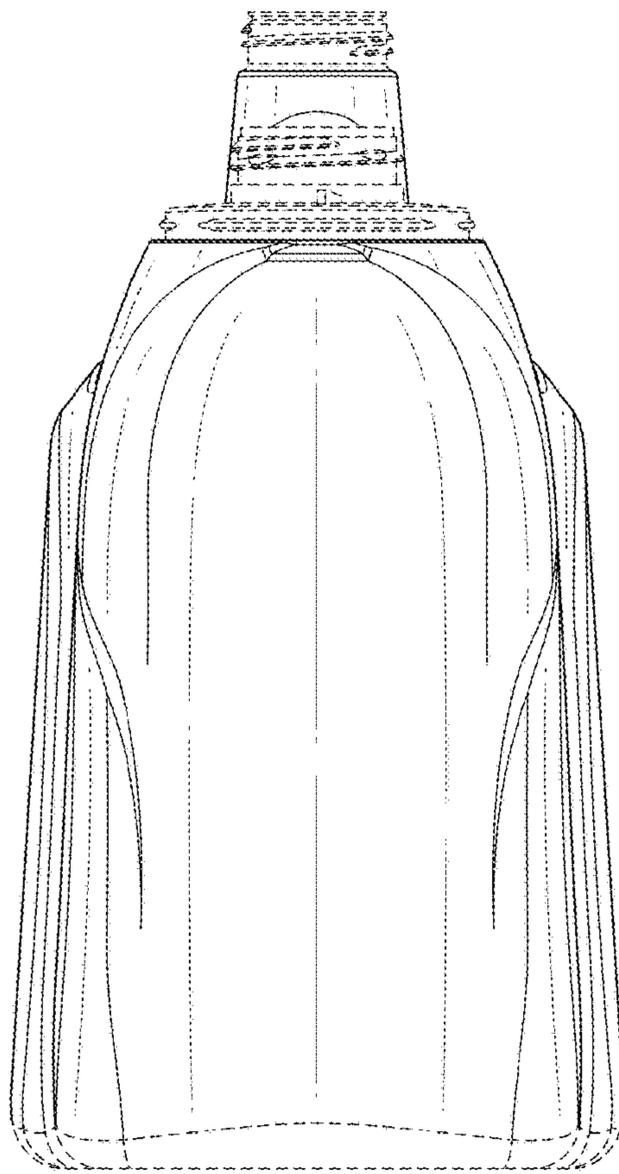

FIG. 5

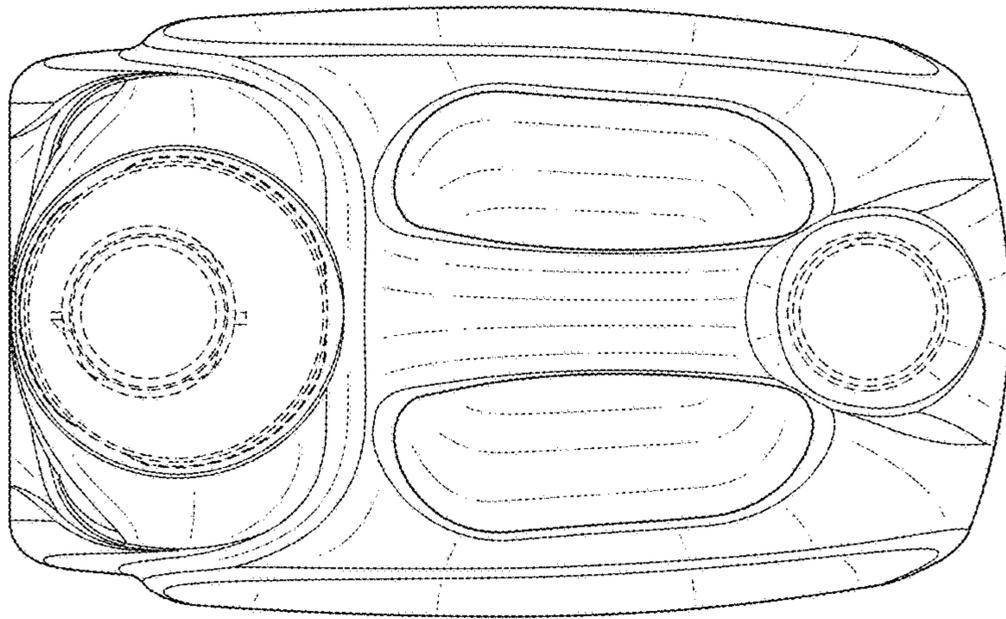

FIG. 6

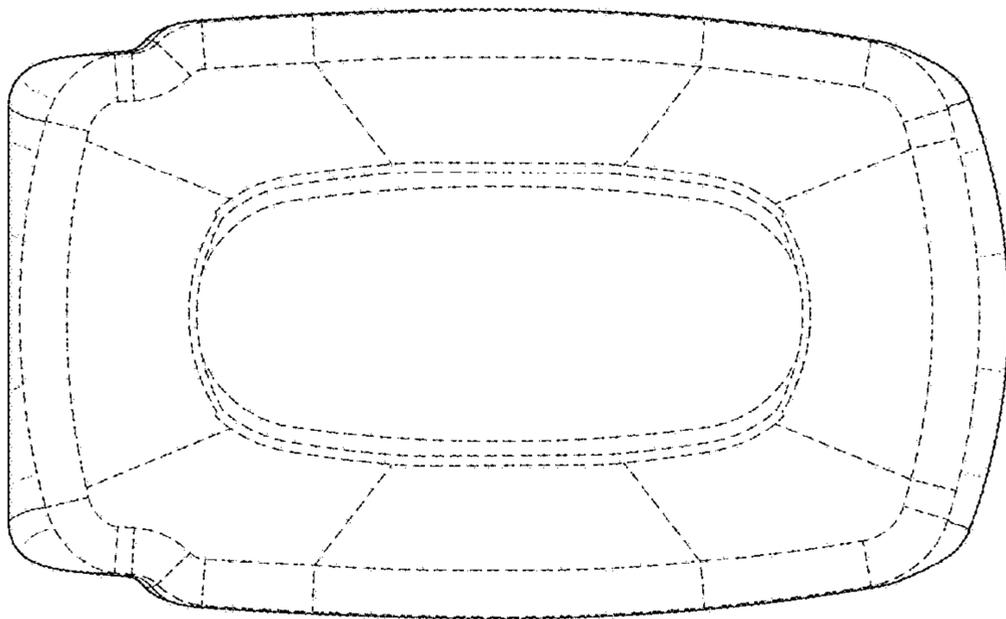

FIG. 7

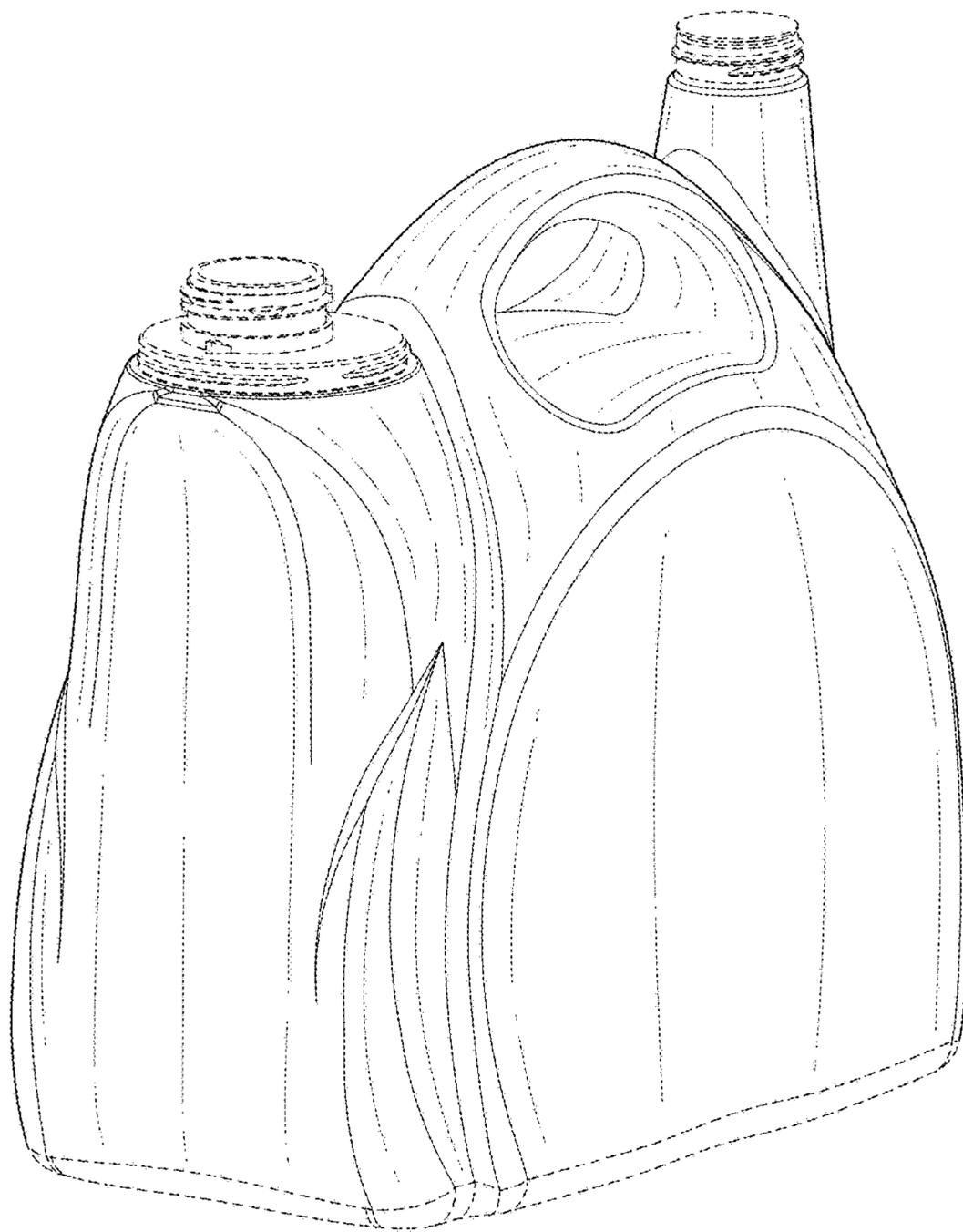

FIG. 8

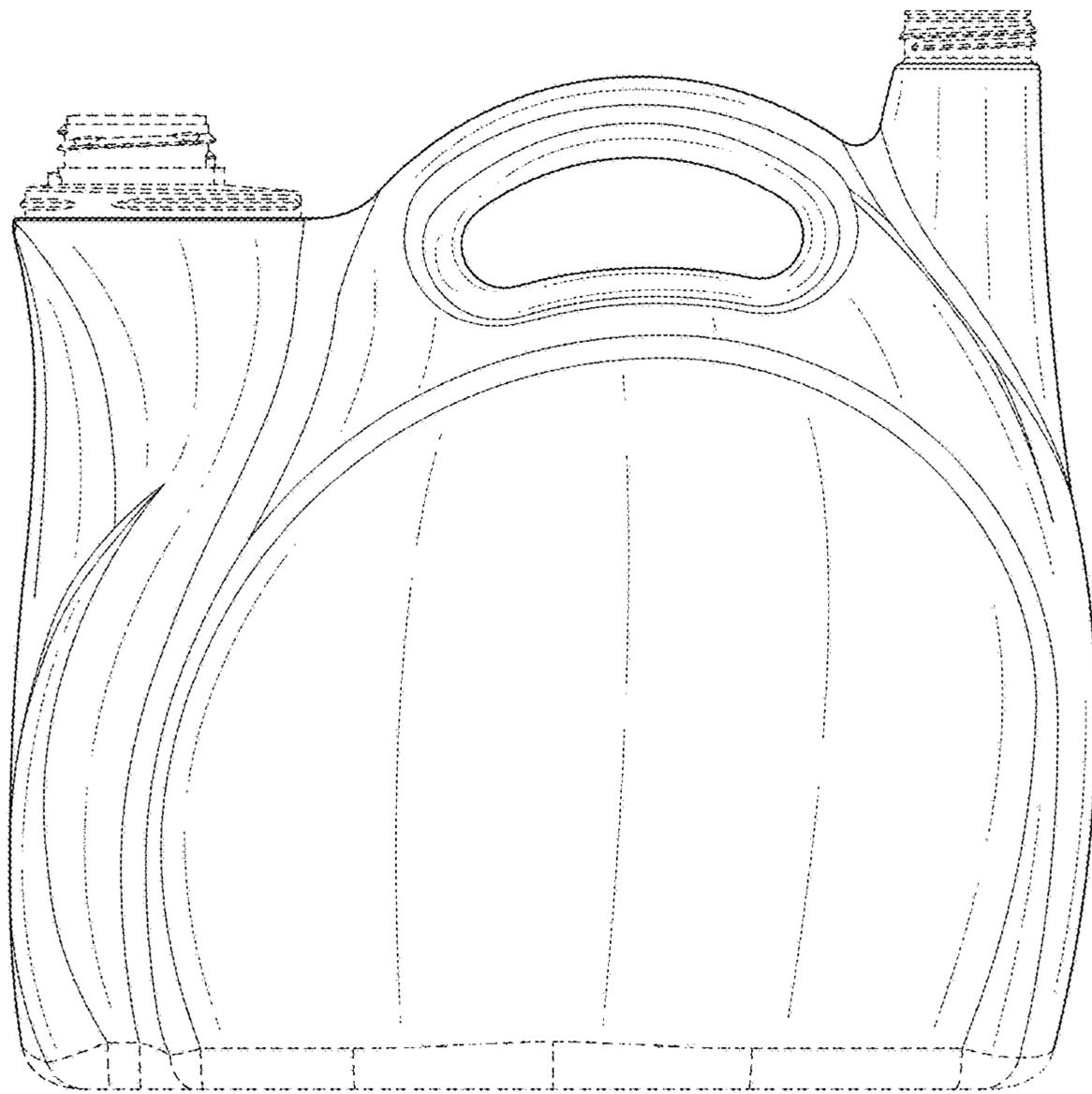

FIG. 9

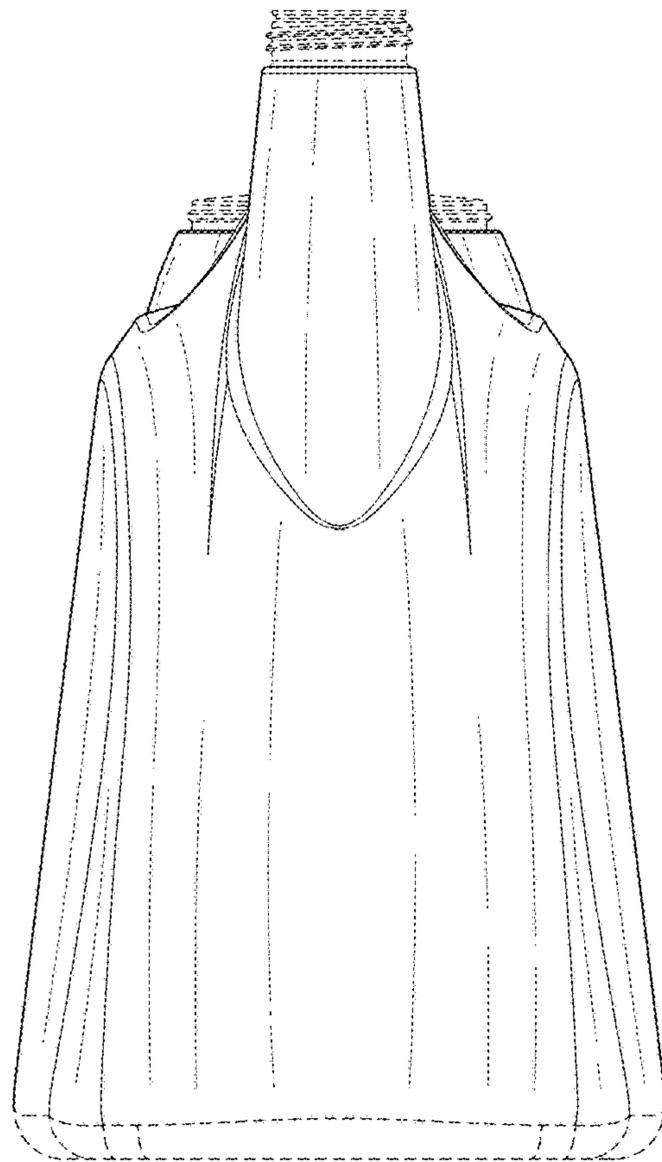

FIG. 10

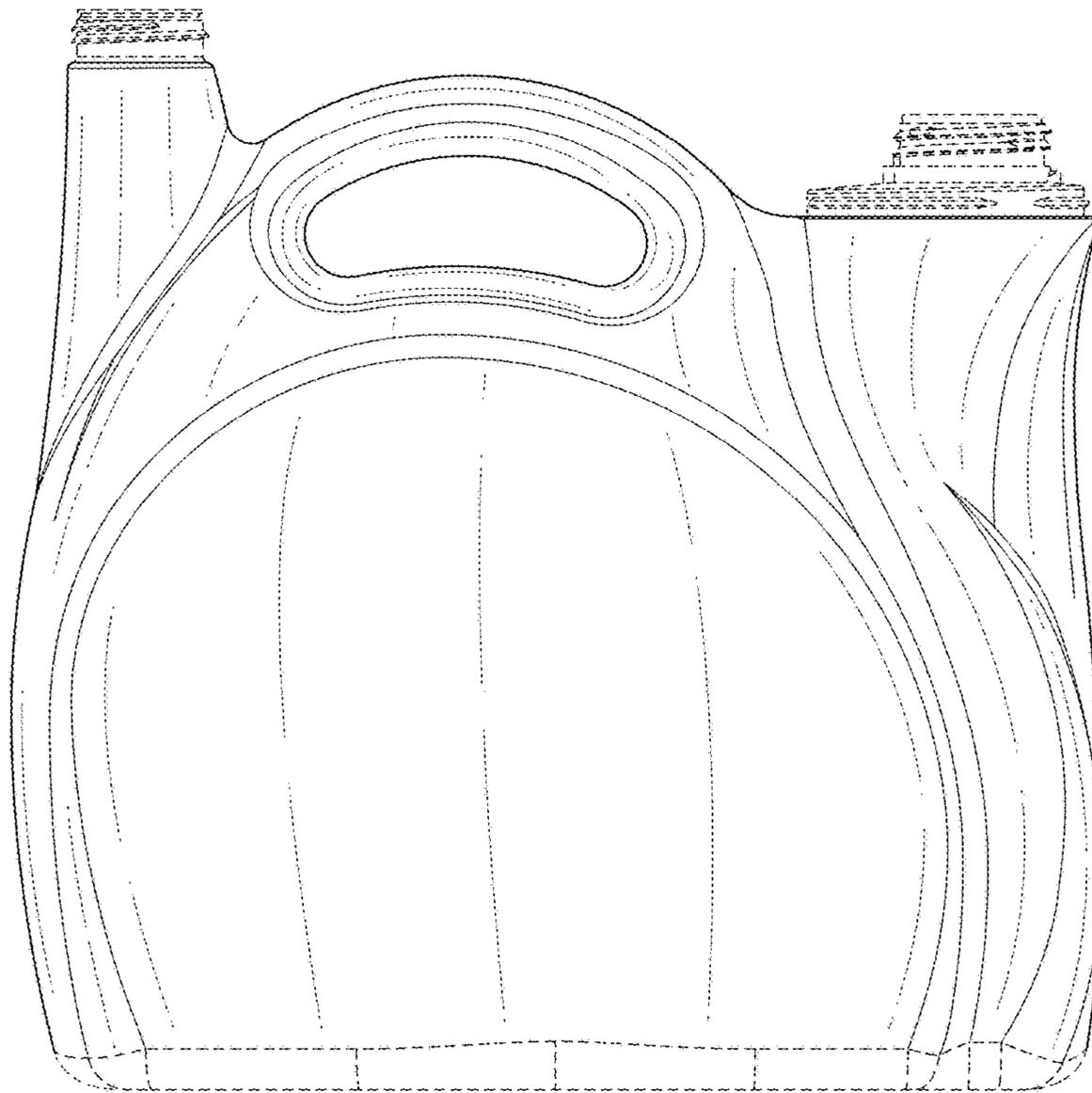

FIG. 11

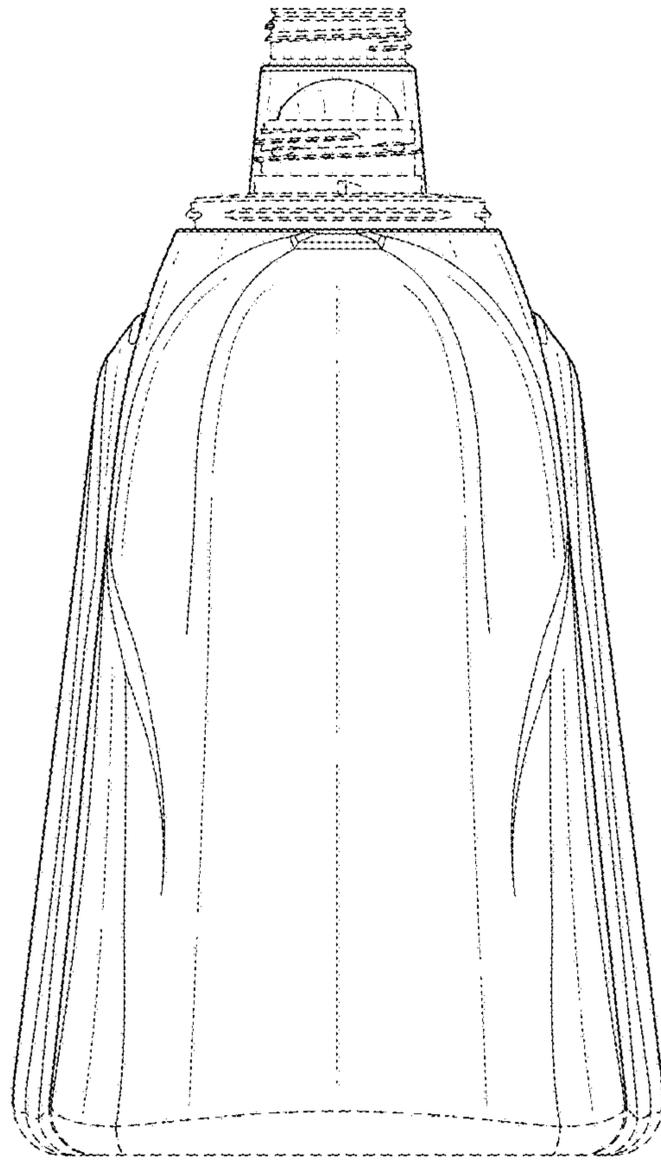

FIG. 12

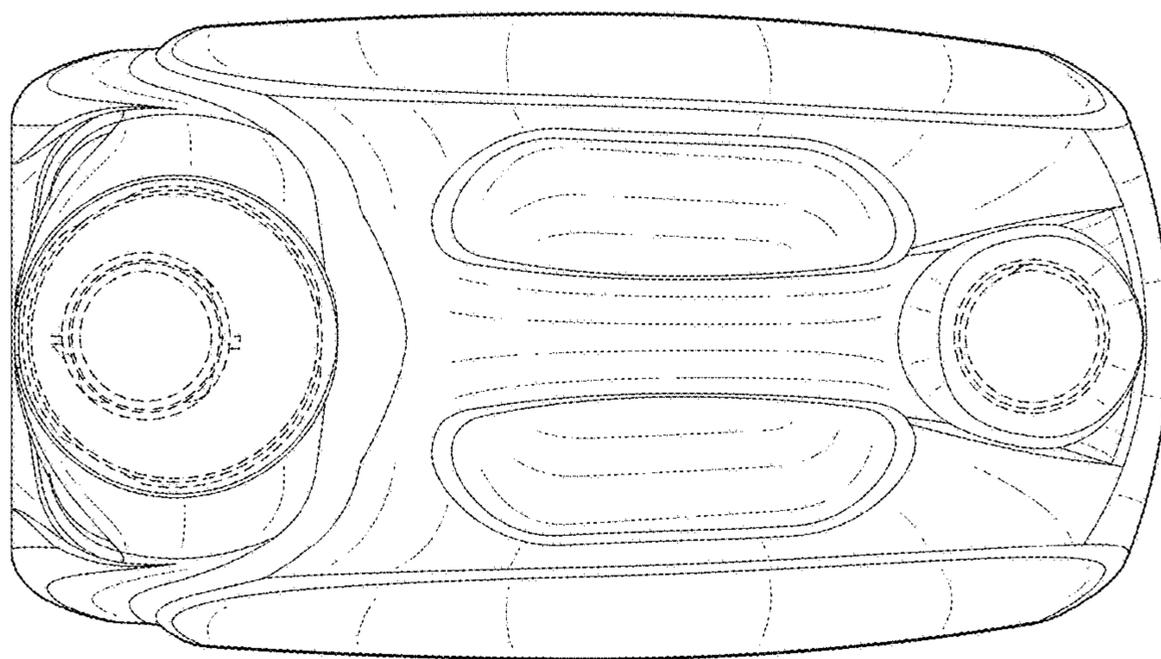

FIG. 13

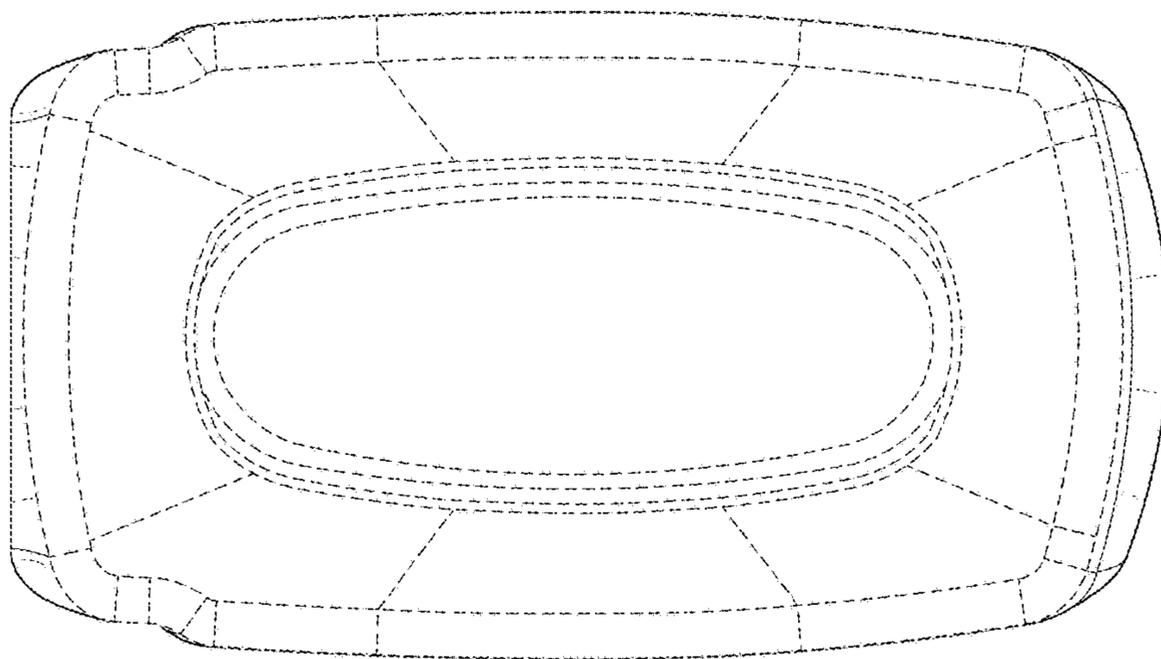

FIG. 14