



US00D850051S

(12) **United States Design Patent**
Harrison et al.

(10) **Patent No.:** **US D850,051 S**
(45) **Date of Patent:** **** May 28, 2019**

- (54) **CART**
- (71) Applicant: **Unarco Industries LLC**, Wagoner, OK (US)
- (72) Inventors: **William Timothy Harrison**, Muskogee, OK (US); **Gregory Eric Dallen**, Broken Arrow, OK (US); **Ryan Witchey**, Olathe, KS (US); **Wesley McMurtrey**, Bixby, OK (US)
- (73) Assignee: **Unarco Industries LLC**, Wagoner, OK (US)
- (**) Term: **15 Years**
- (21) Appl. No.: **29/632,667**
- (22) Filed: **Jan. 9, 2018**
- (51) **LOC (11) Cl.** **12-02**
- (52) **U.S. Cl.**
USPC **D34/27; D34/17**
- (58) **Field of Classification Search**
USPC **D34/12-27**
CPC **B62B 3/027; B62B 3/1444; B62B 3/14; B62B 3/144; B62B 3/1496; B62B 3/1404; B62B 5/06; B62B 3/02; B62B 2202/67; B62B 5/00; B62B 5/0006; B62B 5/069; B62B 5/0423**
See application file for complete search history.

D294,419 S *	2/1988	Rehrig	D34/17
6,749,204 B2 *	6/2004	Werner	B62B 3/1472
				224/411
7,063,337 B2 *	6/2006	Russell	B62B 3/144
				280/33.992
D530,478 S *	10/2006	Splain	D34/27
D546,021 S *	7/2007	Splain	D34/27
D550,423 S *	9/2007	Splain	D34/12
D556,413 S *	11/2007	Splain	D34/12
D591,474 S	4/2009	Peota et al.		
7,766,347 B2 *	8/2010	Ryan	B62B 3/144
				280/30
D628,759 S *	12/2010	Walter	D34/27
D644,810 S *	9/2011	Peota	D34/17
D646,041 S *	9/2011	Berthiaume	D34/21
D802,868 S	11/2017	Sherman et al.		
D802,869 S	11/2017	Sherman et al.		
D818,237 S *	5/2018	Walter	D34/27
D821,049 S *	6/2018	Lazzarino	D34/17
2002/0135144 A1 *	9/2002	Murar	B62B 3/1404
				280/33.991

(Continued)

Primary Examiner — Cynthia Ramirez

(74) *Attorney, Agent, or Firm* — Banner & Witcoff, Ltd.

(57) **CLAIM**

The ornamental design for a cart, as shown and described.

DESCRIPTION

FIG. 1 is a top, front, right perspective view of a cart showing our new design;
 FIG. 2 is a right side view thereof;
 FIG. 3 is a left side view thereof;
 FIG. 4 is a rear view thereof;
 FIG. 5 is a front view thereof;
 FIG. 6 is a top view thereof; and,
 FIG. 7 is a bottom view thereof.
 The broken lines showing the remainder of the cart represent unclaimed subject matter and form no part of the claimed design.

1 Claim, 7 Drawing Sheets

(56) **References Cited**

U.S. PATENT DOCUMENTS

2,890,057 A *	6/1959	Davis	B62B 3/144
				280/33.993
2,906,542 A *	9/1959	Hoedinghaus	B62B 3/14
				220/8
2,931,662 A *	4/1960	Young	B62B 3/144
				280/33.993
D283,264 S *	4/1986	Levy-Joseph	D34/17

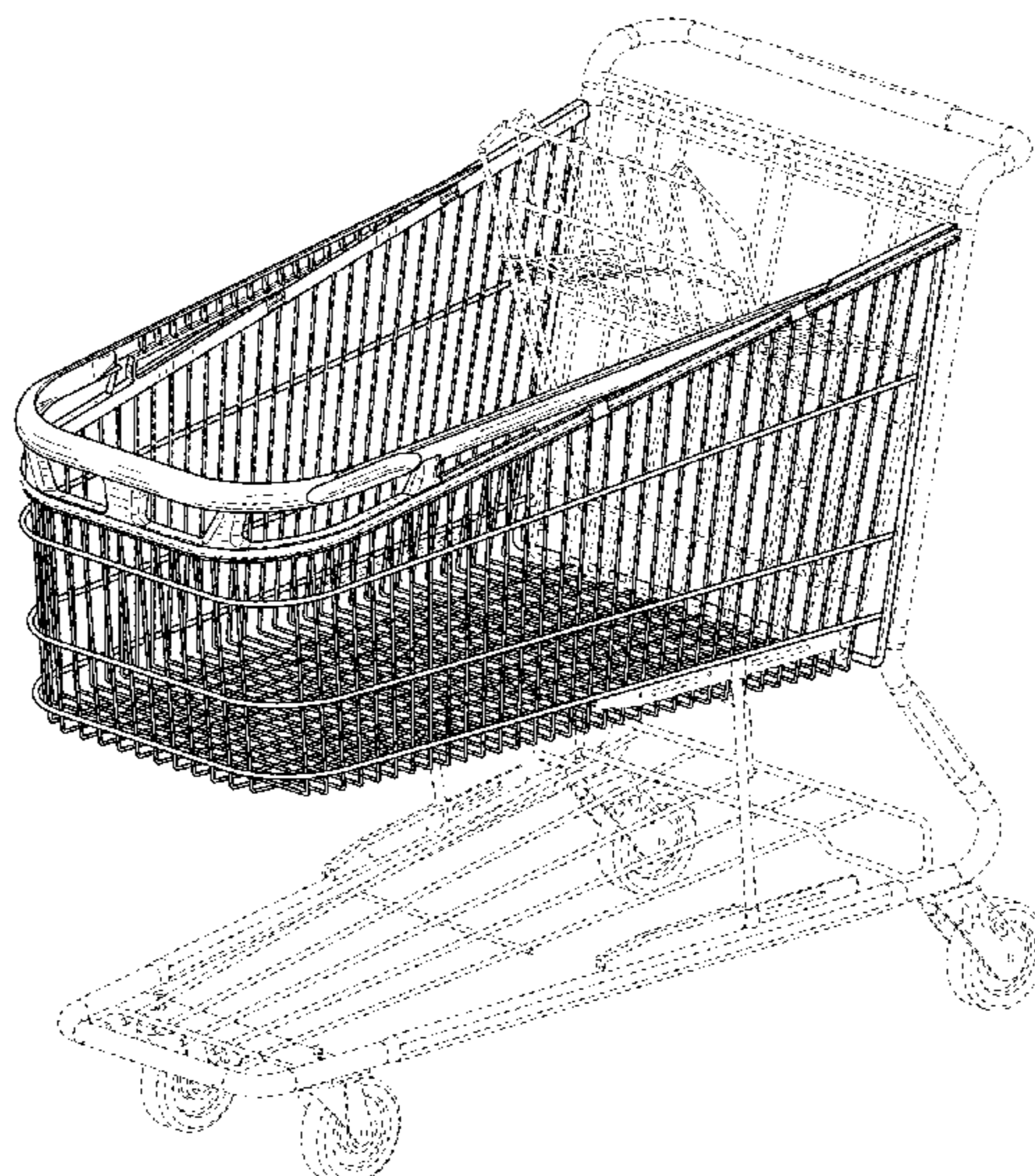

(56)

References Cited

U.S. PATENT DOCUMENTS

2003/0057666 A1* 3/2003 Murar B62B 3/14
280/33.991
2004/0046341 A1* 3/2004 Wilkinson B62B 3/1404
280/33.991
2007/0063461 A1* 3/2007 Peota B62B 3/144
280/33.992

* cited by examiner



FIG. 1

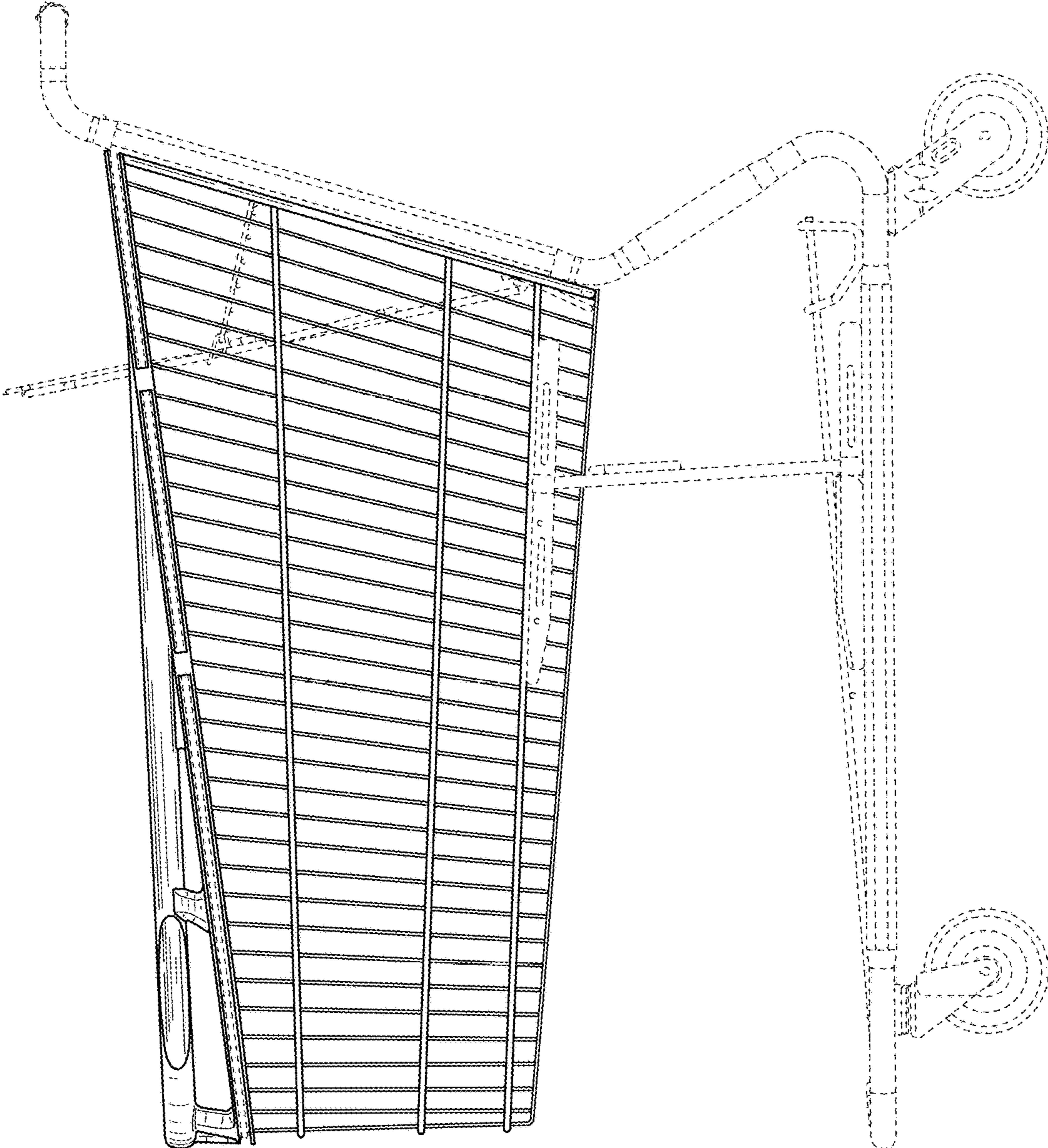

FIG. 2

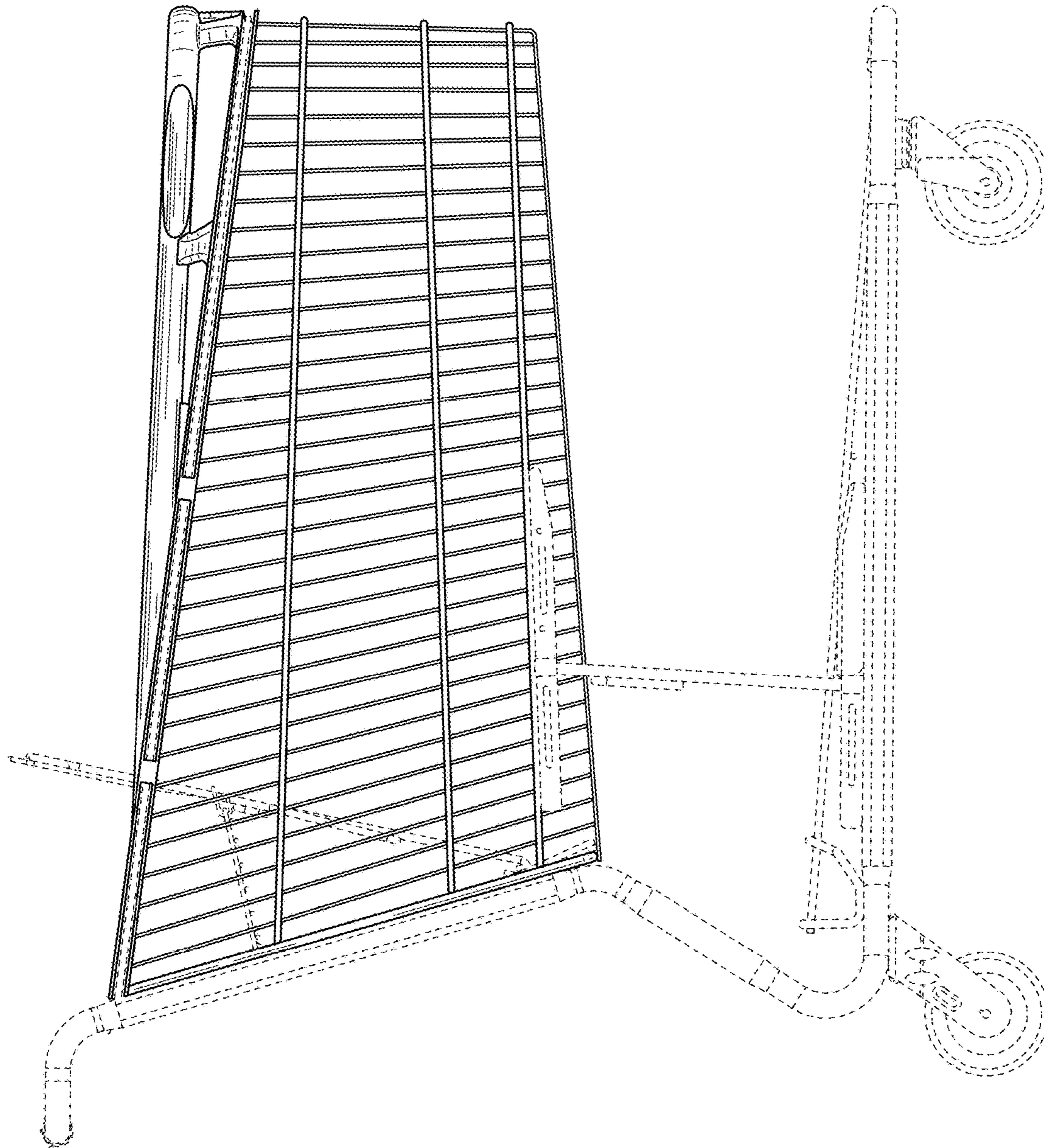

FIG. 3

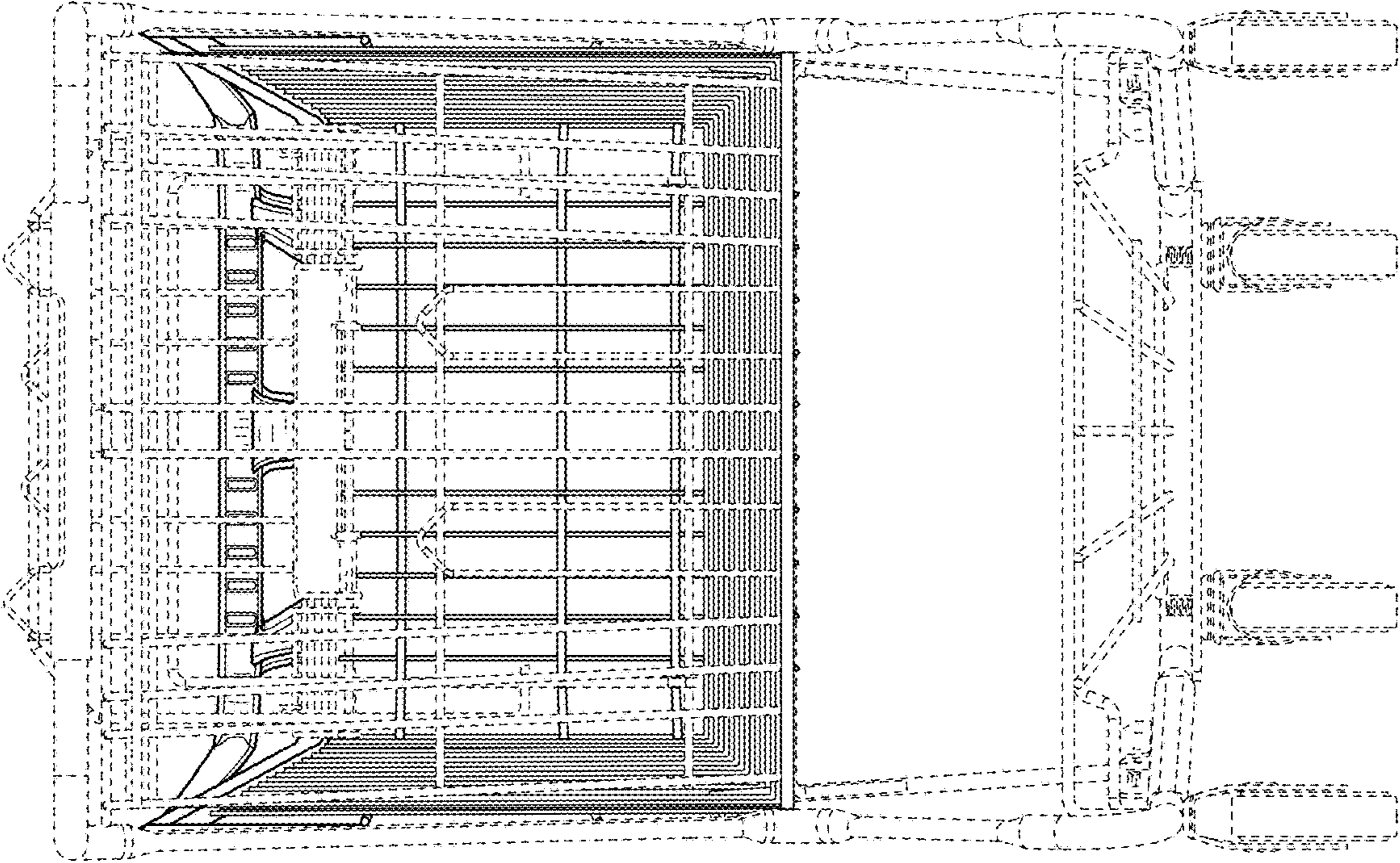

FIG. 4

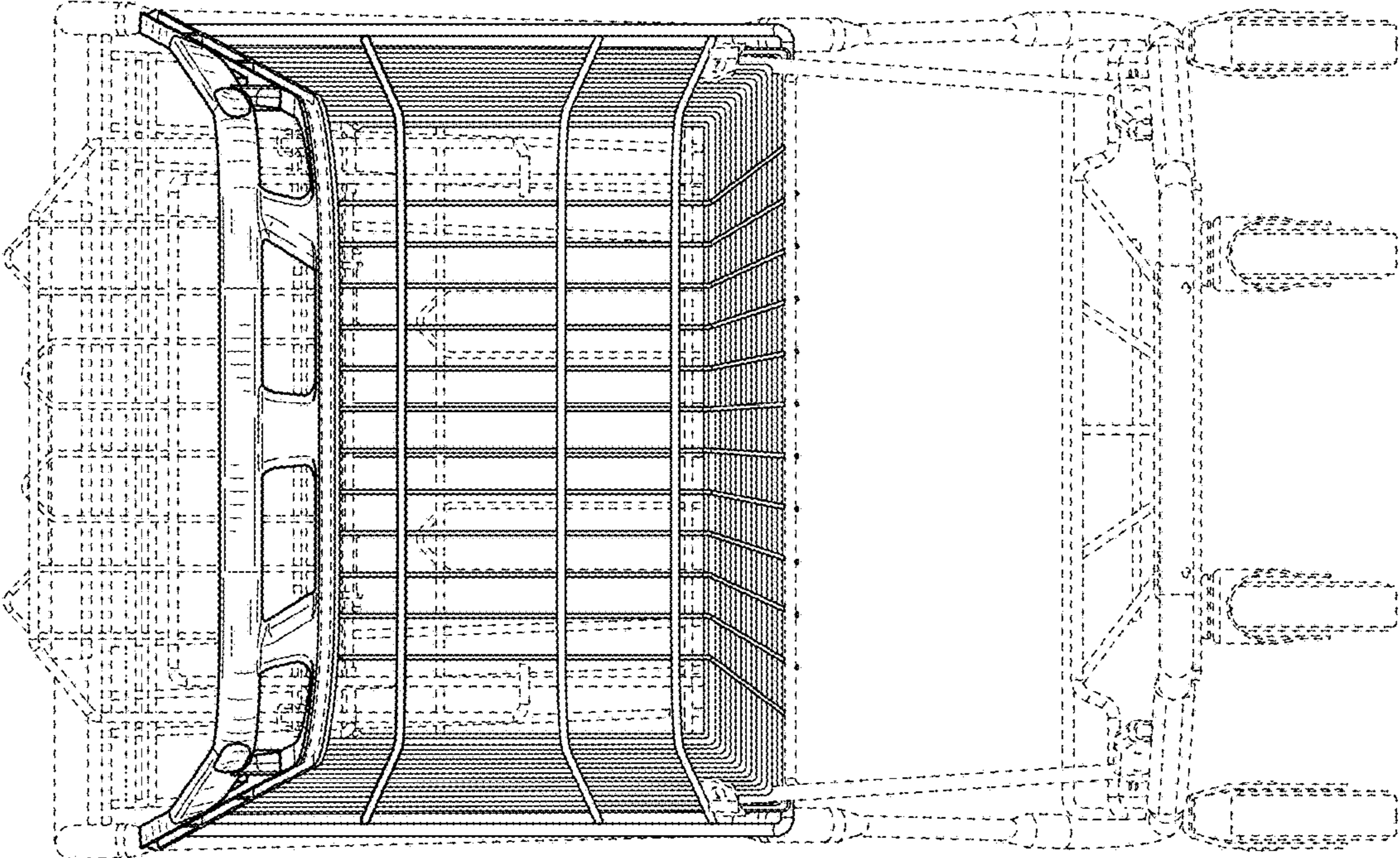

FIG. 5

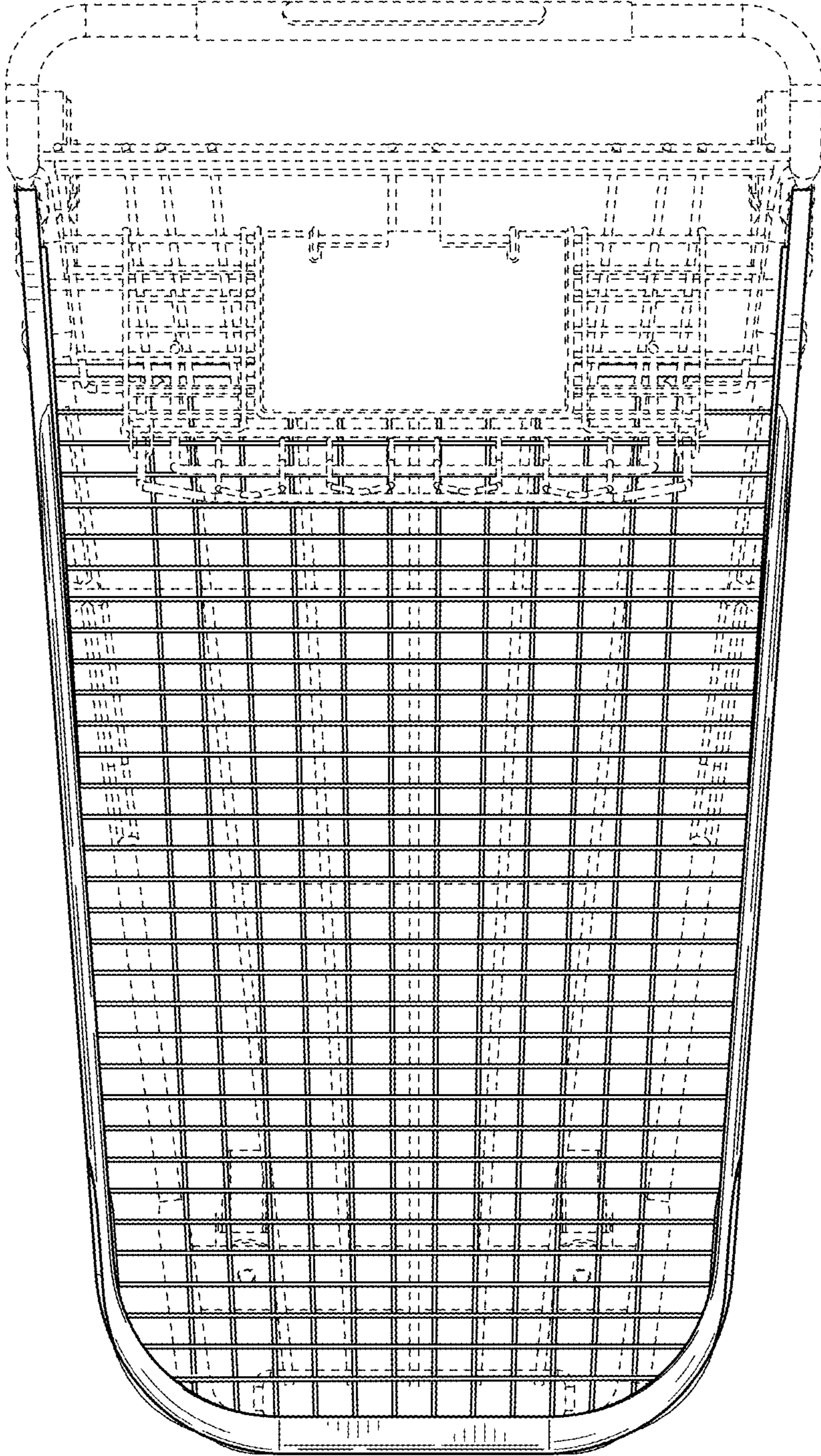

FIG. 6

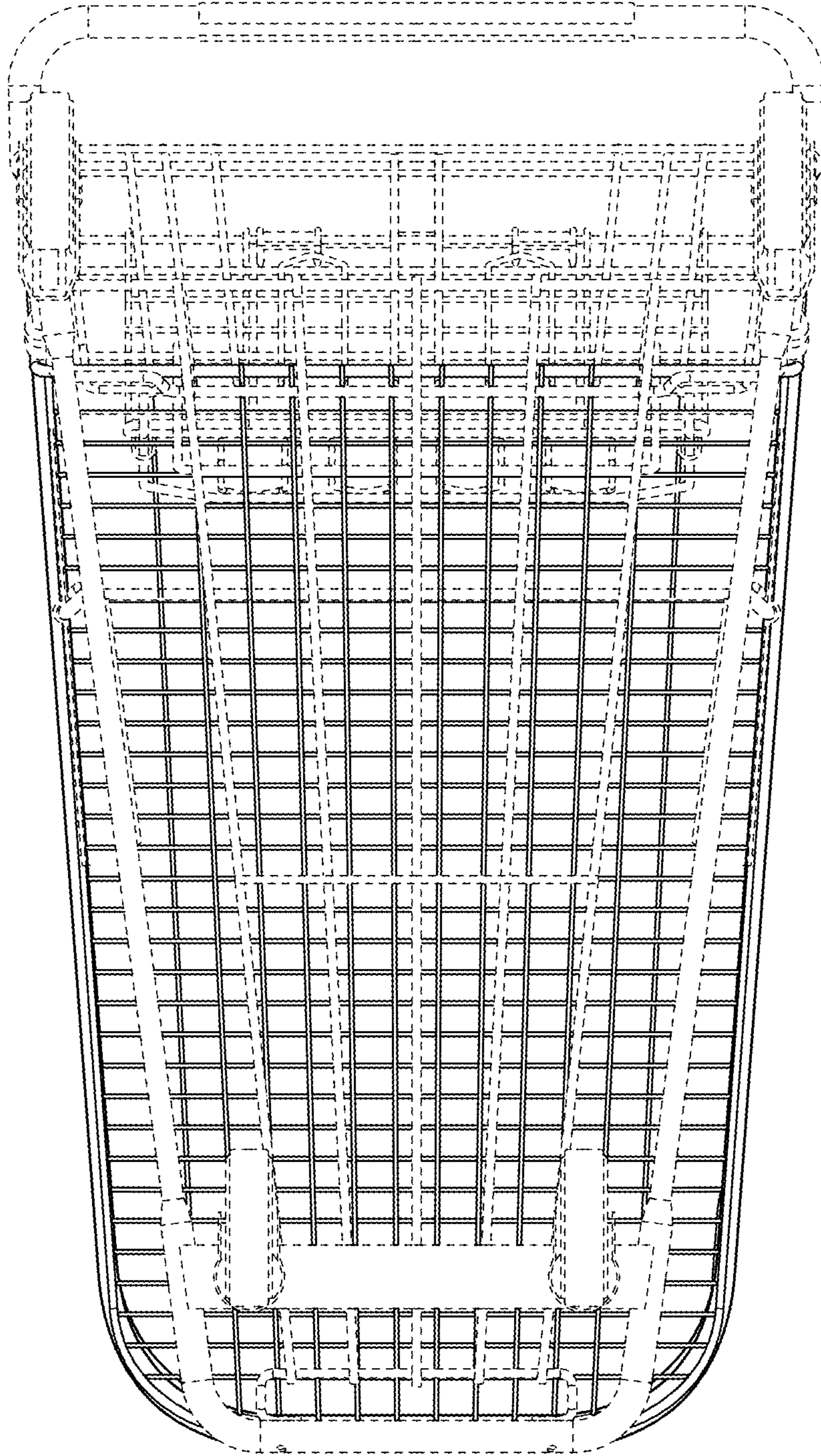

FIG. 7