



US00D850046S

(12) **United States Design Patent** (10) **Patent No.:** **US D850,046 S**  
**Shippen et al.** (45) **Date of Patent:** **\*\* May 28, 2019**

(54) **COMBINATION WHISK BROOM WITH SQUEEGEE AND DUSTPAN**

FOREIGN PATENT DOCUMENTS

(71) Applicant: **NELI LLC**, Orem, UT (US)

CN	303418777	* 10/2015
GB	4010488	3/2009
KR	300896680	* 3/2017

(72) Inventors: **Scott M. Shippen**, Orem, UT (US);  
**Ben R. Shippen**, Orem, UT (US);  
**Stephen R. Shippen**, Orem, UT (US);  
**David S. Shippen**, Orem, UT (US)

OTHER PUBLICATIONS

(73) Assignee: **NELI LLC**, Orem, UT (US)

Libman Dust Pan with Whisk Broom | eBay, <https://www.ebay.com/itm/Libman-Dust-Pan-with-Whisk-Broom-/362103006307>, [site visited Jun. 25, 2018].\*

(\*\*) Term: **15 Years**

(Continued)

(21) Appl. No.: **29/616,659**

*Primary Examiner* — John Windmuller

*Assistant Examiner* — John R Yeh

(22) Filed: **Sep. 7, 2017**

(74) *Attorney, Agent, or Firm* — Workman Nydegger

(57) **CLAIM**

The ornamental design for a combination whisk broom with squeegee and dustpan, as shown and described.

**Related U.S. Application Data**

**DESCRIPTION**

(63) Continuation of application No. 29/549,310, filed on Dec. 21, 2015, now abandoned, which is a (Continued)

FIG. 1 is a perspective view of a combination whisk broom with squeegee and dustpan according to the present invention;

(51) **LOC (11) Cl.** ..... **07-05**

(52) **U.S. Cl.**

FIG. 2 is a front view of the combination whisk broom with squeegee and dustpan of FIG. 1;

USPC ..... **D32/50**; D32/74

(58) **Field of Classification Search**

FIG. 3 is a rear view of the combination whisk broom with squeegee and dustpan of FIG. 1;

USPC ..... D32/15, 40, 45, 50–52, 74; D4/130–133

CPC . A47L 13/10; A47L 13/20; A47L 7/00; A47L

FIG. 4 is a first side view of the combination whisk broom with squeegee and dustpan of FIG. 1;

5/24; A47L 13/16; A47L 13/12; B32B

FIG. 5 is a second, opposite side view of the combination whisk broom with squeegee and dustpan of FIG. 1;

27/04; A01D 7/06

See application file for complete search history.

FIG. 6 is a bottom view of the combination whisk broom with squeegee and dustpan of FIG. 1;

(56) **References Cited**

**U.S. PATENT DOCUMENTS**

468,433 A \* 2/1892 Bishop ..... A47L 13/52  
15/257.2

FIG. 7 is a top view of the combination whisk broom with squeegee and dustpan of FIG. 1; and,

673,511 A 5/1901 Benning

FIG. 8 is a perspective view of the combination whisk broom with squeegee and dustpan of FIG. 1 with the dustpan separated from the combination broom with squeegee.

(Continued)

**1 Claim, 8 Drawing Sheets**

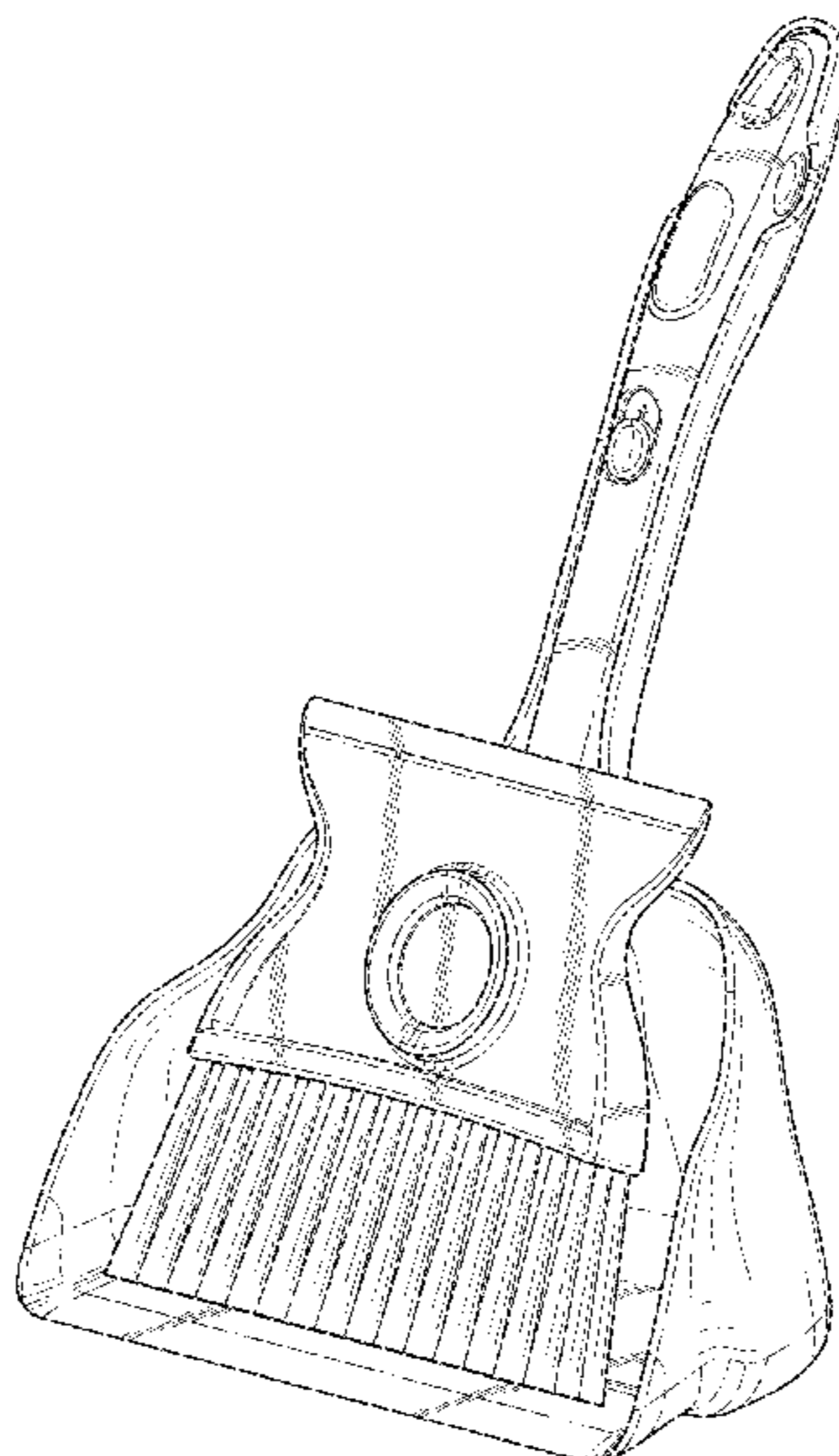

**Related U.S. Application Data**

continuation-in-part of application No. 14/955,854, filed on Dec. 1, 2015, now Pat. No. 9,532,694, and a continuation-in-part of application No. 14/149,429, filed on Jan. 7, 2014, now Pat. No. 9,538,895.

(56)

**References Cited**

U.S. PATENT DOCUMENTS

720,761	A	2/1903	Wade	
729,338	A	5/1903	Hawkins	
898,316	A	9/1908	Carlson	
D41,853	S *	10/1911	Foster	D4/130
D145,887	S *	11/1946	Fox	D32/74
2,455,695	A *	12/1948	Monaco	A47L 13/52 15/105
2,534,086	A	12/1950	Vosbikian	
2,741,788	A	4/1956	Shey	
3,082,455	A *	3/1963	Evancha	A47L 13/52 15/105
3,968,535	A	7/1976	Nichols	
4,756,039	A *	7/1988	Pardo	A46B 9/06 15/159.1
D318,350	S *	7/1991	Muffuletto	294/176
5,207,755	A	5/1993	Ampian	
D350,233	S *	9/1994	Joyner	D4/132
5,425,153	A	6/1995	Vosbikian	
5,664,279	A *	9/1997	Vosbikian	A46B 15/0055 15/168
D463,643	S *	9/2002	Petner	D32/74
D468,110	S *	1/2003	Libman	D4/138
D492,489	S *	7/2004	Hay	D32/74
D510,165	S *	9/2005	Berti	D32/74
7,171,719	B1	2/2007	Harrelson	
D548,977	S *	8/2007	Hay	D4/135
D594,618	S *	6/2009	ekercicio lu	D32/74
8,196,249	B1	6/2012	Spooner	
D675,070	S *	1/2013	Rockwell	D7/691
D699,412	S *	2/2014	Smith	D32/50

8,904,589	B2	12/2014	Santarsiero et al.	
9,247,804	B2	2/2016	Butler	
9,474,428	B2	10/2016	Sampaio	
9,532,694	B1	1/2017	Shippen et al.	
9,538,895	B1 *	1/2017	Shippen	A47L 13/12
2002/0184728	A1 *	12/2002	Kortleven	A46B 15/0095 15/257.2
2003/0051301	A1	3/2003	Morgan	
2003/0084529	A1	5/2003	Rudd	
2007/0020357	A1	1/2007	Shippen	
2007/0234497	A1	10/2007	Lee	
2008/0072388	A1	3/2008	Jones	
2009/0140536	A1 *	6/2009	Claypool	A47F 13/08 294/176
2009/0223007	A1	9/2009	Li	
2011/0302735	A1 *	12/2011	Santarsiero	A47L 13/11 15/117
2012/0260453	A1	10/2012	Ward	
2016/0113382	A1	4/2016	Sampaio	
2016/0235271	A1	8/2016	Zhu	
2016/0242618	A1	8/2016	Schiavo	

OTHER PUBLICATIONS

U.S. Appl. No. 29/549,310, filed Dec. 21, 2015, Shippen et al. Cleaningquickie. "Spill Collector by Quickie Manufacturing." YouTube, Jul. 30, 2013. Web. Accessed Dec. 17, 2014. <https://www.youtube.com/watch?v=NJakCDTdw9U>. 1 page.

Amazon.com: One Small Hand Broom, review date Feb. 12, 2015, [https://www.amazon.com/Small-Hand-Broom-Snap-Colors/dp/BOOQEYCSQU?ref=cm\\_cr\\_arp\\_d\\_producUop?ie=UTF8](https://www.amazon.com/Small-Hand-Broom-Snap-Colors/dp/BOOQEYCSQU?ref=cm_cr_arp_d_producUop?ie=UTF8), [site visited Apr. 29, 2017 4:15:20 PM] 7 pages.

U.S. Appl. No. 14/149,429, dated May 17, 2016, Office Action.

U.S. Appl. No. 14/955,854, dated May 26, 2016, Office Action.

U.S. Appl. No. 14/149,429, dated Sep. 2, 2016, Notice of Allowance.

U.S. Appl. No. 14/558,854, dated Sep. 6, 2016, Notice of Allowance.

U.S. Appl. No. 29/549,310, dated Jun. 8, 2016, Office Action.

\* cited by examiner

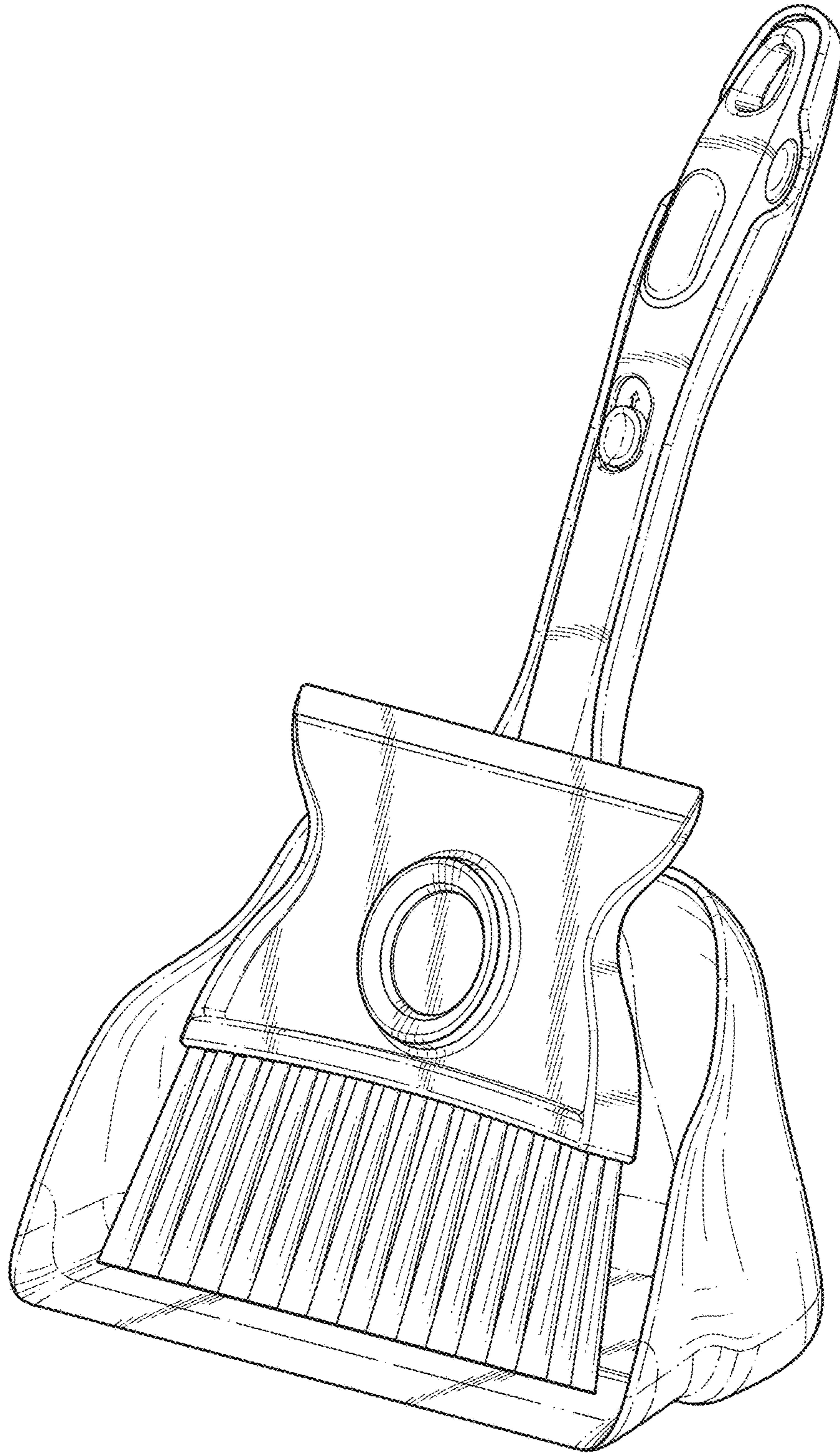

FIG. 1

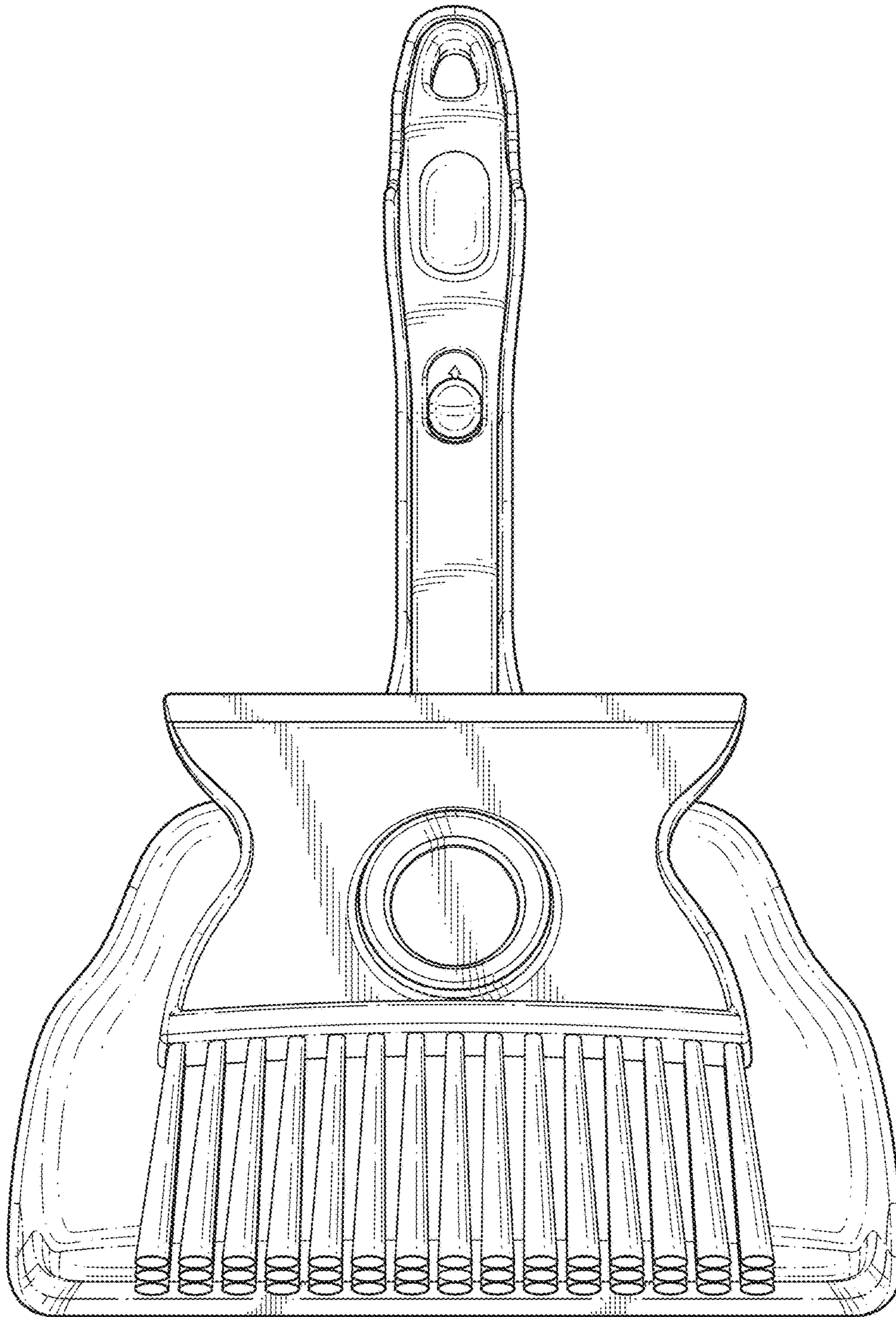

FIG. 2

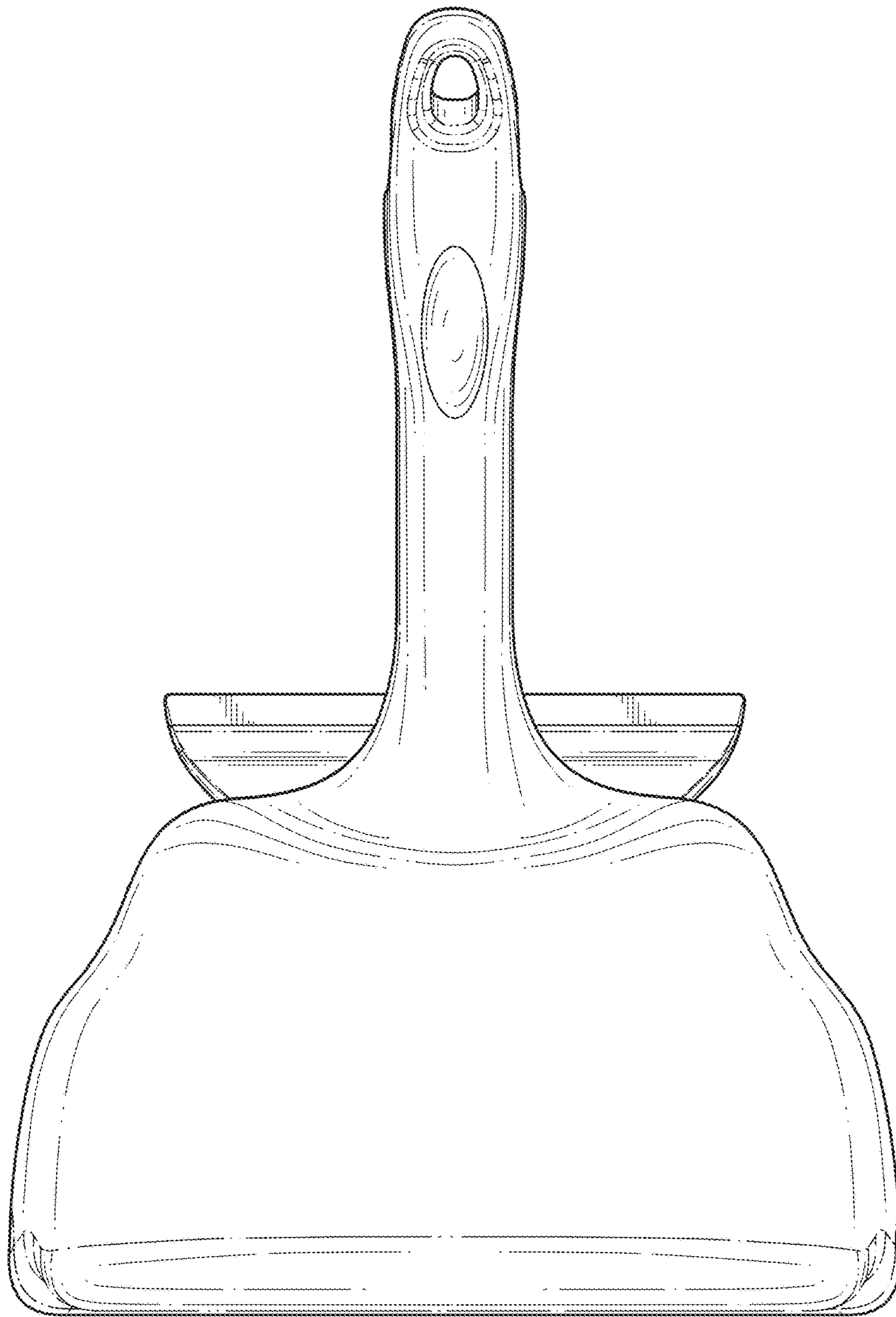

FIG. 3



FIG. 4



FIG. 5

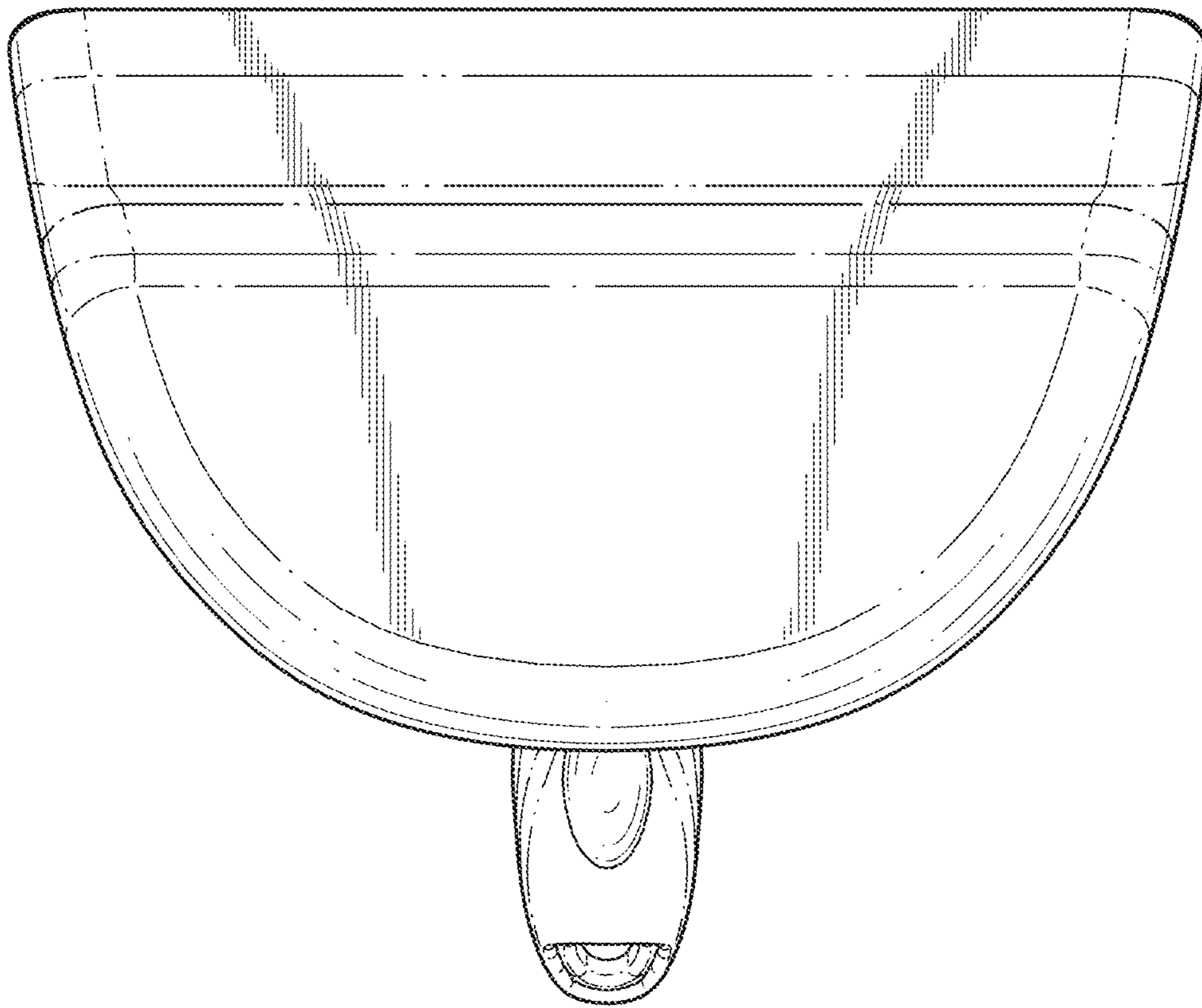

FIG. 6



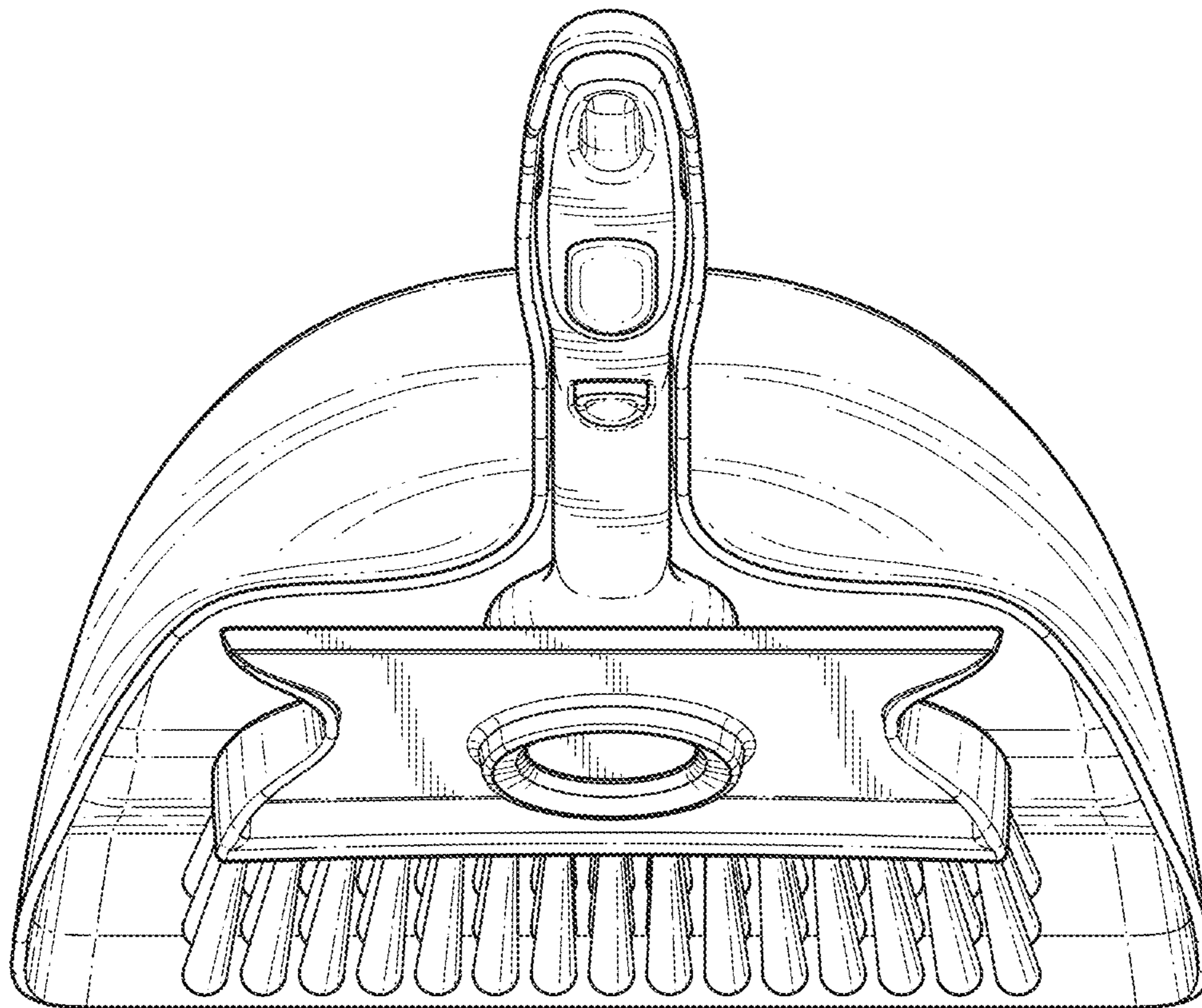

FIG. 7

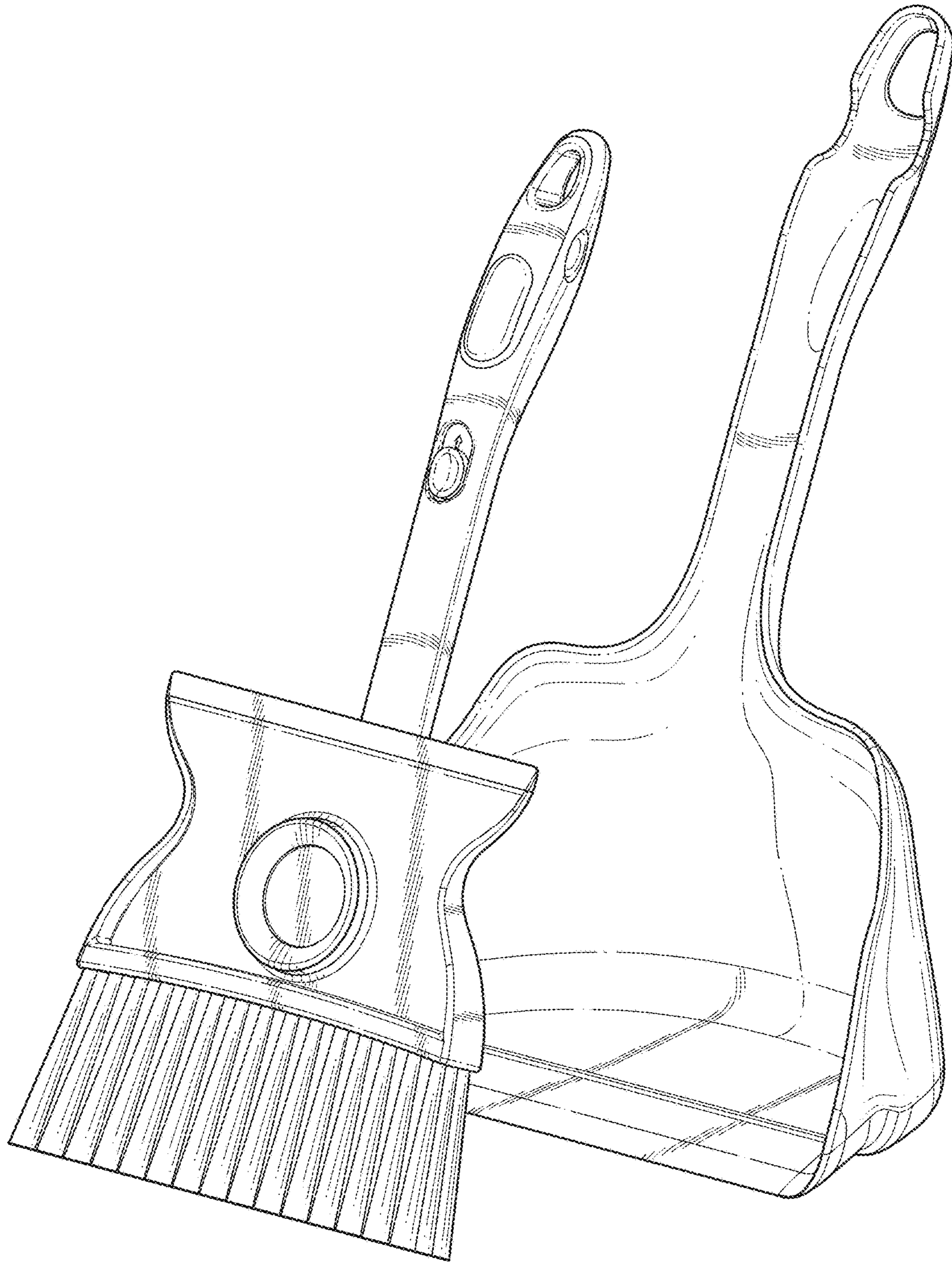

FIG. 8