

US00D850035S

(12) **United States Design Patent** (10) **Patent No.:** **US D850,035 S**
Yoon et al. (45) **Date of Patent:** **** May 28, 2019**

(54) **WASHING MACHINE**
(71) Applicant: **SAMSUNG ELECTRONICS CO., LTD.**, Suwon-si, Gyeonggi-do (KR)
(72) Inventors: **Sanghun Yoon**, Seoul (KR); **Yuna Park**, Seoul (KR); **Myunggyu Kim**, Seoul (KR); **Ahjung Joo**, Seoul (KR)
(73) Assignee: **SAMSUNG ELECTRONICS CO., LTD.**, Gyeonggi-Do (KR)
(**) Term: **15 Years**

D359,602 S 6/1995 Swartz et al.
D360,500 S 7/1995 Millet et al.
D374,954 S 10/1996 Katz et al.
D380,883 S 7/1997 Katz et al.
D457,991 S 5/2002 Baldwin et al.
D465,308 S 11/2002 Resuello et al.
D470,632 S 2/2003 Oda
D489,496 S 5/2004 Sneddon
D491,324 S 6/2004 Kim et al.
D492,073 S 6/2004 Sneddon
D516,258 S 2/2006 Matsusaki et al.
D517,257 S 3/2006 Kim et al.
D519,692 S 4/2006 Jun
D524,000 S 6/2006 Kim et al.
D526,453 S 8/2006 Jun

(Continued)

(21) Appl. No.: **29/648,688**

(22) Filed: **May 23, 2018**

Related U.S. Application Data

(63) Continuation of application No. 29/607,235, filed on Jun. 12, 2017, now Pat. No. Des. 824,123, which is a continuation of application No. 29/590,790, filed on Jan. 13, 2017, now Pat. No. Des. 825,867.

(30) **Foreign Application Priority Data**

Nov. 29, 2016 (KR) 30-2016-0057634

(51) **LOC (11) Cl.** **15-05**

(52) **U.S. Cl.**
USPC **D32/6**

(58) **Field of Classification Search**

USPC D32/29.1, 29, 28, 6, 25, 8, 1, 5, 10
CPC D06F 39/045; D06F 29/00; D06F 29/005;
D06F 25/00; D06F 39/022; D06F 33/02;
D06F 2204/065; D06F 35/006

See application file for complete search history.

(56) **References Cited**

U.S. PATENT DOCUMENTS

4,307,588 A 12/1981 Smith et al.
4,429,817 A 2/1984 Ikeda

FOREIGN PATENT DOCUMENTS

CN 303423821 S 10/2015
KR 300387514 S 7/2005
KR 300768037 S 11/2014

Primary Examiner — Michelle E. Wilson

(74) *Attorney, Agent, or Firm* — Cantor Colburn LLP

(57) **CLAIM**

We claim the ornamental design for a washing machine, as shown and described.

DESCRIPTION

FIG. 1 is the front perspective view of a washing machine showing our new design;
FIG. 2 is the front view thereof;
FIG. 3 is the rear view thereof;
FIG. 4 is the left-side view thereof;
FIG. 5 is the right-side view thereof;
FIG. 6 is the top view thereof; and,
FIG. 7 is the bottom view thereof.

The broken lines in the figures depict environmental subject matter and form no part of the claimed design.

1 Claim, 7 Drawing Sheets

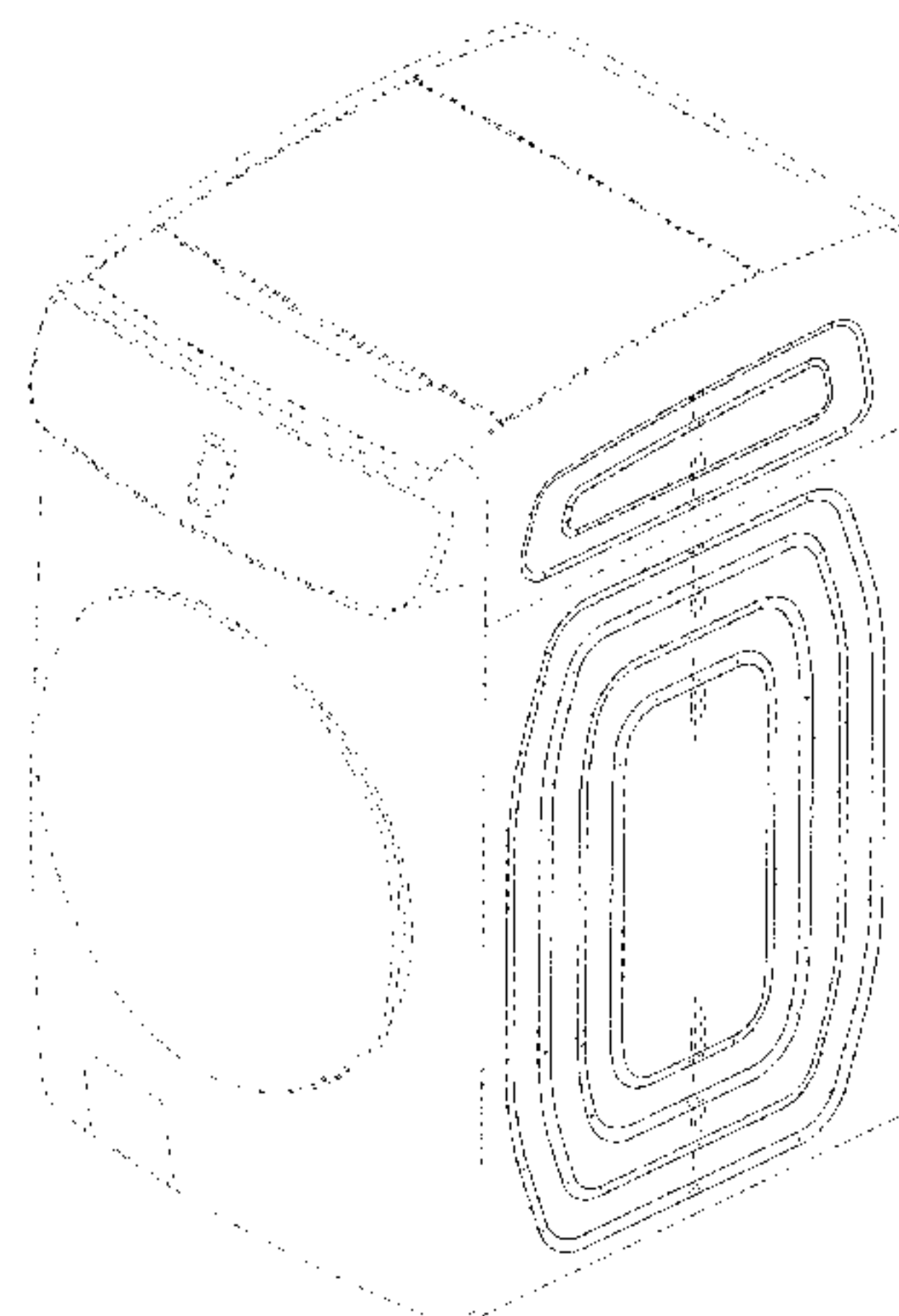

(56)

References Cited

U.S. PATENT DOCUMENTS

D527,150 S 8/2006 Jun
 D527,853 S 9/2006 Carey et al.
 D528,712 S 9/2006 Ha et al.
 D528,713 S 9/2006 Ha et al.
 D532,941 S 11/2006 Carey et al.
 D536,144 S 1/2007 Seo et al.
 D538,488 S * 3/2007 Carey D32/6
 D542,487 S 5/2007 Jun
 D542,986 S 5/2007 Crookshanks
 D542,987 S 5/2007 Crookshanks
 D554,307 S 10/2007 Kim
 D556,394 S 11/2007 Kim
 D571,964 S 6/2008 Kim
 D575,012 S 8/2008 Rossetto et al.
 D575,464 S 8/2008 Rossetto et al.
 D575,913 S 8/2008 Jeon et al.
 D577,162 S 9/2008 Shail et al.
 D588,757 S 3/2009 Park et al.
 D597,712 S 8/2009 Jeon et al.
 D617,960 S * 6/2010 Bohm D32/6
 D620,650 S 7/2010 Lee
 D625,476 S 10/2010 Lee et al.
 D626,299 S 10/2010 Lee et al.
 D630,807 S 1/2011 Song et al.
 D631,215 S 1/2011 Song et al.
 D631,624 S 1/2011 Chung et al.
 D632,033 S 2/2011 Song et al.
 D633,261 S 2/2011 Song et al.
 D642,752 S * 8/2011 Kim D32/6
 D642,753 S * 8/2011 Ha D32/6
 D648,084 S 11/2011 Browne et al.
 D648,085 S 11/2011 Miller et al.
 D648,497 S 11/2011 Bhattacharya
 D648,907 S 11/2011 Jeon et al.
 D649,722 S 11/2011 Chung et al.
 D653,006 S * 1/2012 Takahashi D32/6
 D654,640 S 2/2012 Song et al.
 D658,340 S * 4/2012 Jeon D32/6
 D659,307 S 5/2012 Geyer et al.
 D661,852 S 6/2012 Song et al.
 D663,907 S 7/2012 Jeon et al.
 D665,544 S * 8/2012 Jeon D32/6
 D667,179 S * 9/2012 Jeon D32/6
 D679,462 S 4/2013 Zhang et al.
 D693,973 S * 11/2013 Geyer D32/6
 D694,965 S 12/2013 Lee et al.
 D695,474 S 12/2013 Calmeise
 D697,680 S 1/2014 Hwang et al.
 D699,907 S 2/2014 Choi et al.
 D701,656 S 3/2014 Choi et al.

D701,657 S * 3/2014 Chung D32/6
 D701,658 S * 3/2014 Chung D32/6
 D703,885 S 4/2014 Ha et al.
 D703,886 S 4/2014 Ha et al.
 D705,508 S 5/2014 Calmeise
 D712,603 S * 9/2014 Geyer D32/6
 D729,996 S 5/2015 Hwang et al.
 D729,998 S 5/2015 Jeon et al.
 D730,596 S 5/2015 Kim et al.
 D732,763 S 6/2015 Hwang et al.
 D732,767 S 6/2015 Ha et al.
 D733,372 S 6/2015 Song et al.
 D739,096 S 9/2015 Qin et al.
 D739,097 S 9/2015 Qin et al.
 D742,602 S * 11/2015 Kim D32/6
 D746,521 S 12/2015 Ha et al.
 D747,836 S 1/2016 Cho et al.
 D752,830 S * 3/2016 Choi D32/6
 D759,325 S 6/2016 Jeon et al.
 D759,909 S 6/2016 Kim et al.
 D760,454 S 6/2016 Joo et al.
 D762,021 S 7/2016 Qin et al.
 D762,025 S 7/2016 Joo et al.
 D764,120 S 8/2016 Choi et al.
 D764,121 S 8/2016 Choi et al.
 D764,122 S 8/2016 Jo
 D764,123 S 8/2016 Kim et al.
 D764,722 S 8/2016 Jo
 D769,553 S 10/2016 Lee
 D770,103 S 10/2016 Ha et al.
 D770,698 S 11/2016 Lee et al.
 D770,705 S 11/2016 Kang et al.
 D770,706 S 11/2016 Ha et al.
 D770,707 S 11/2016 Ha et al.
 D771,330 S 11/2016 Ha et al.
 D772,499 S 11/2016 Yoon et al.
 D772,500 S 11/2016 Park et al.
 D772,502 S 11/2016 Choi et al.
 D773,128 S 11/2016 Kim et al.
 D773,753 S 12/2016 Kim et al.
 D773,754 S 12/2016 Choi et al.
 D773,755 S 12/2016 Hwang et al.
 D773,757 S 12/2016 Hwang et al.
 D774,714 S 12/2016 Kang et al.
 D774,715 S 12/2016 Kim et al.
 D774,716 S 12/2016 Kim
 D787,759 S * 5/2017 Geyer D32/6
 D796,752 S 9/2017 Bixby et al.
 D798,004 S 9/2017 Bixby et al.
 D800,976 S * 10/2017 Im D32/6
 D801,602 S * 10/2017 Im D32/6

* cited by examiner

FIG. 1

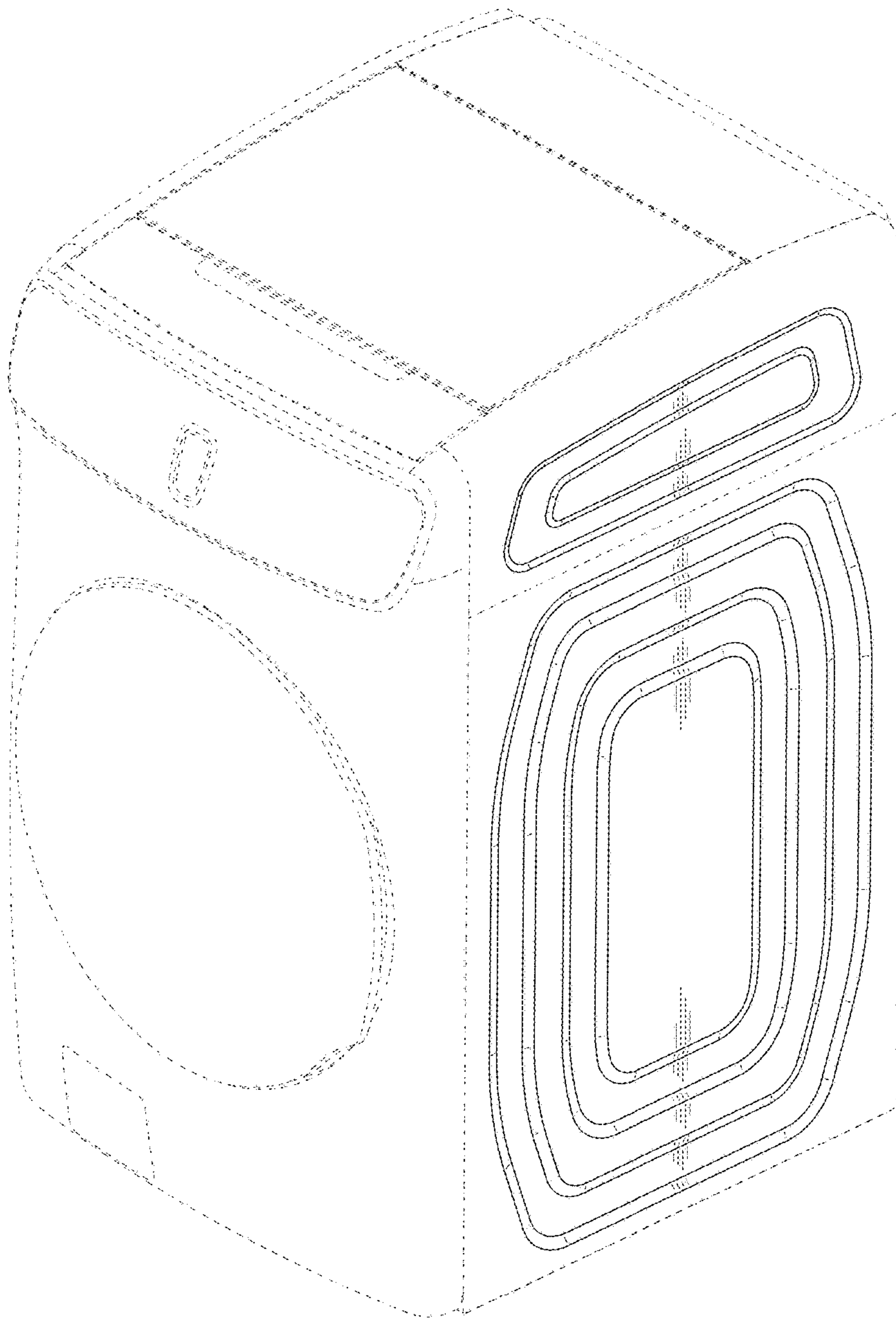

FIG. 2

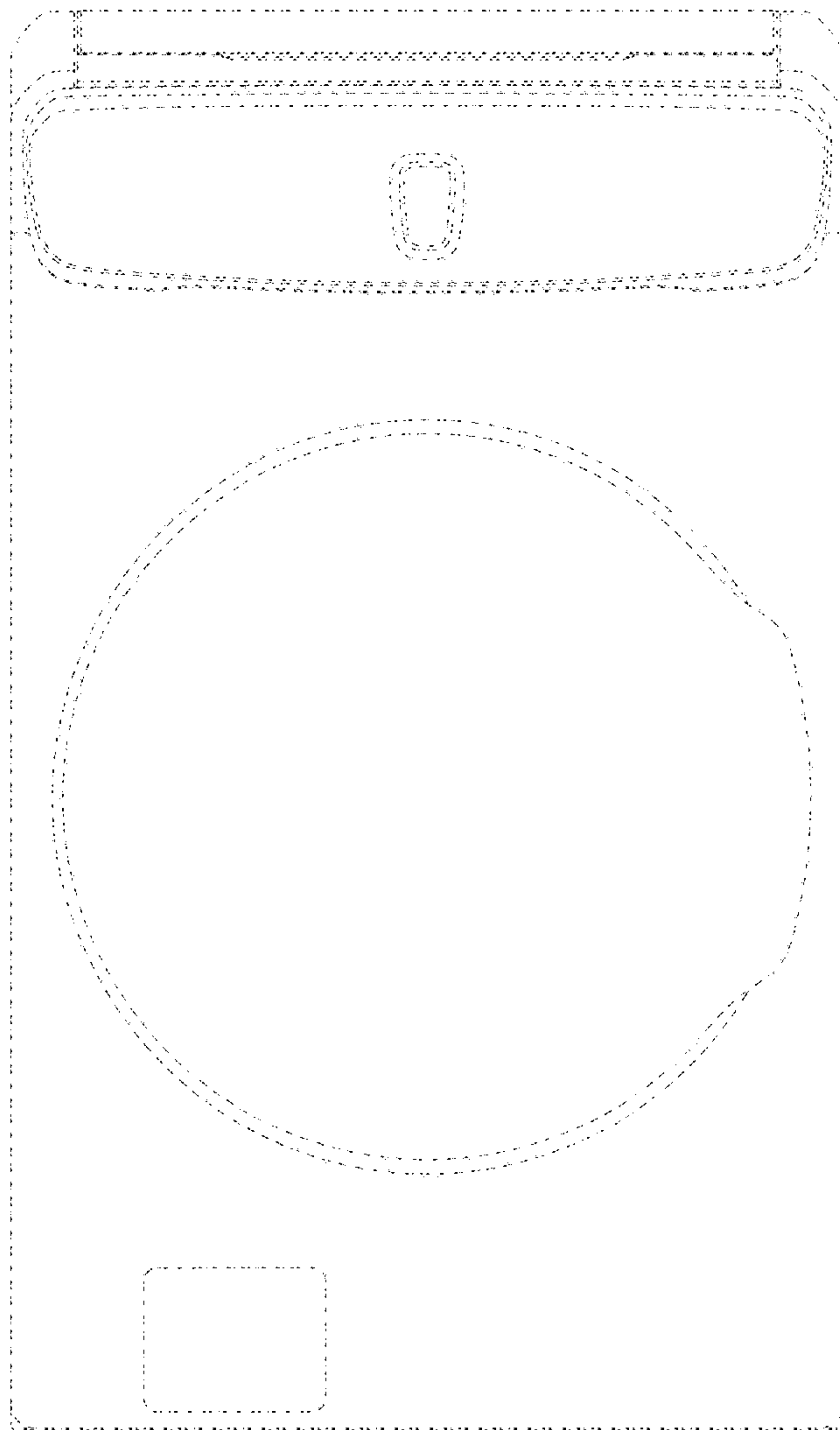

FIG. 3

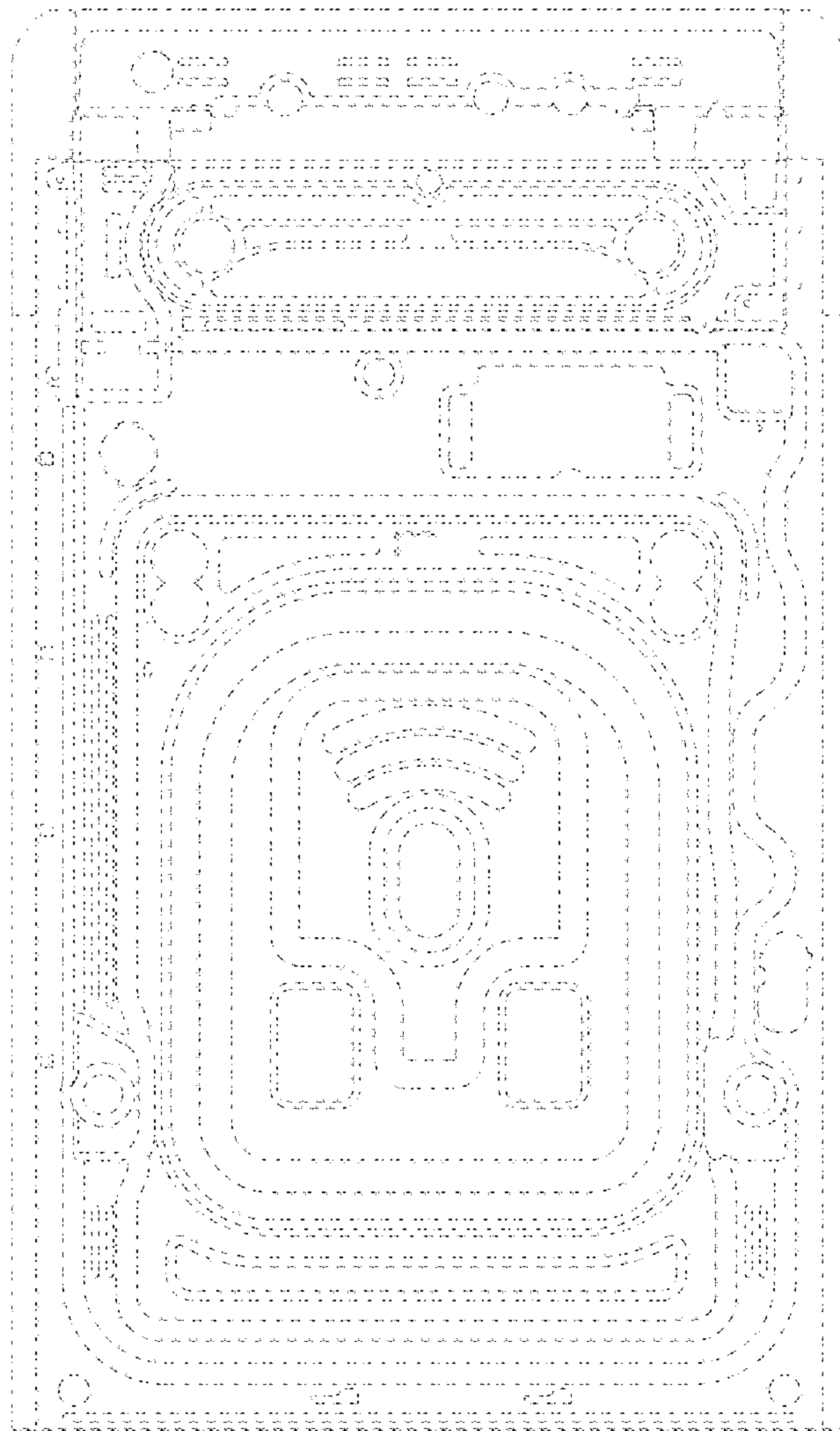

FIG. 4

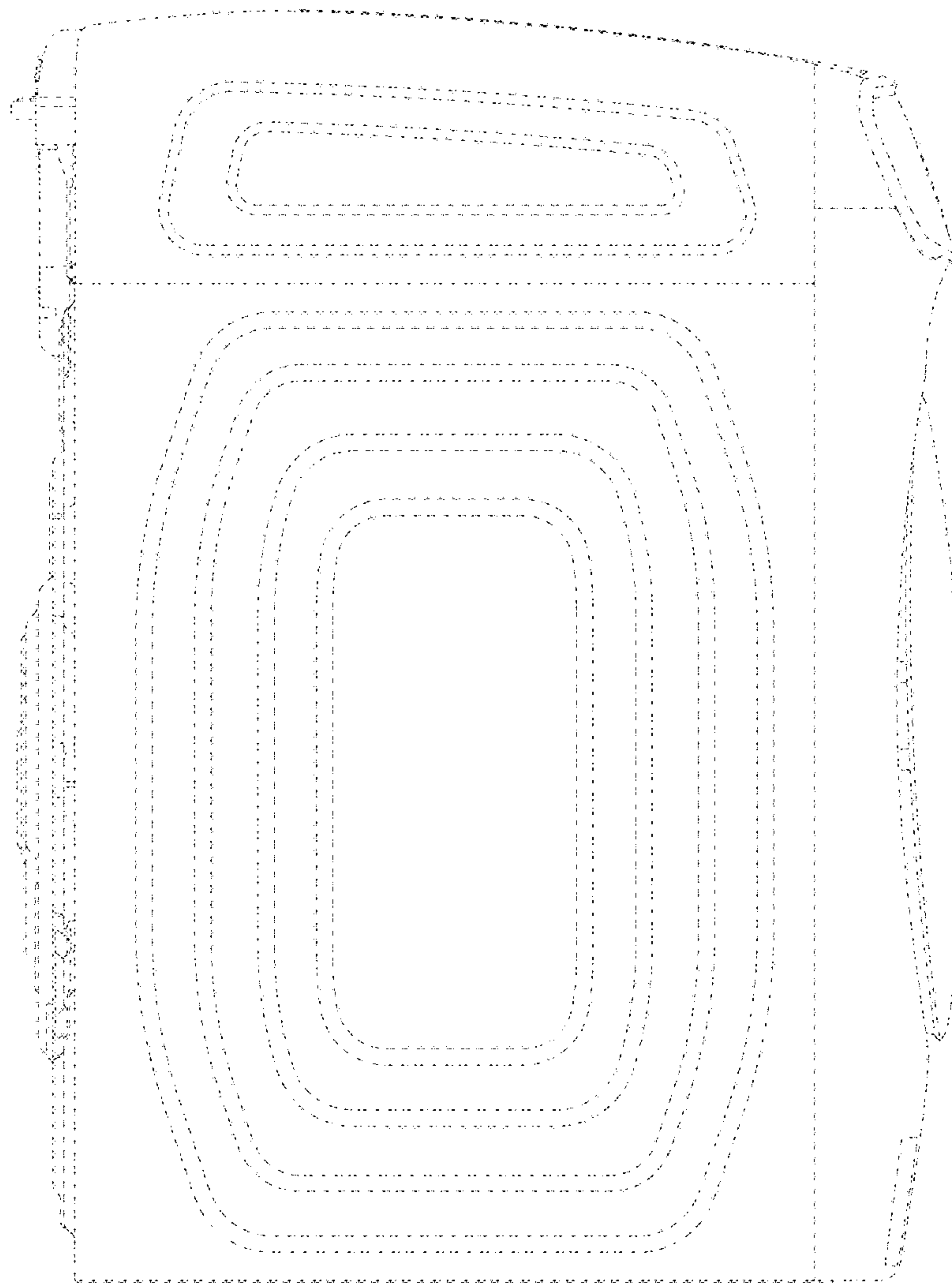

FIG. 5

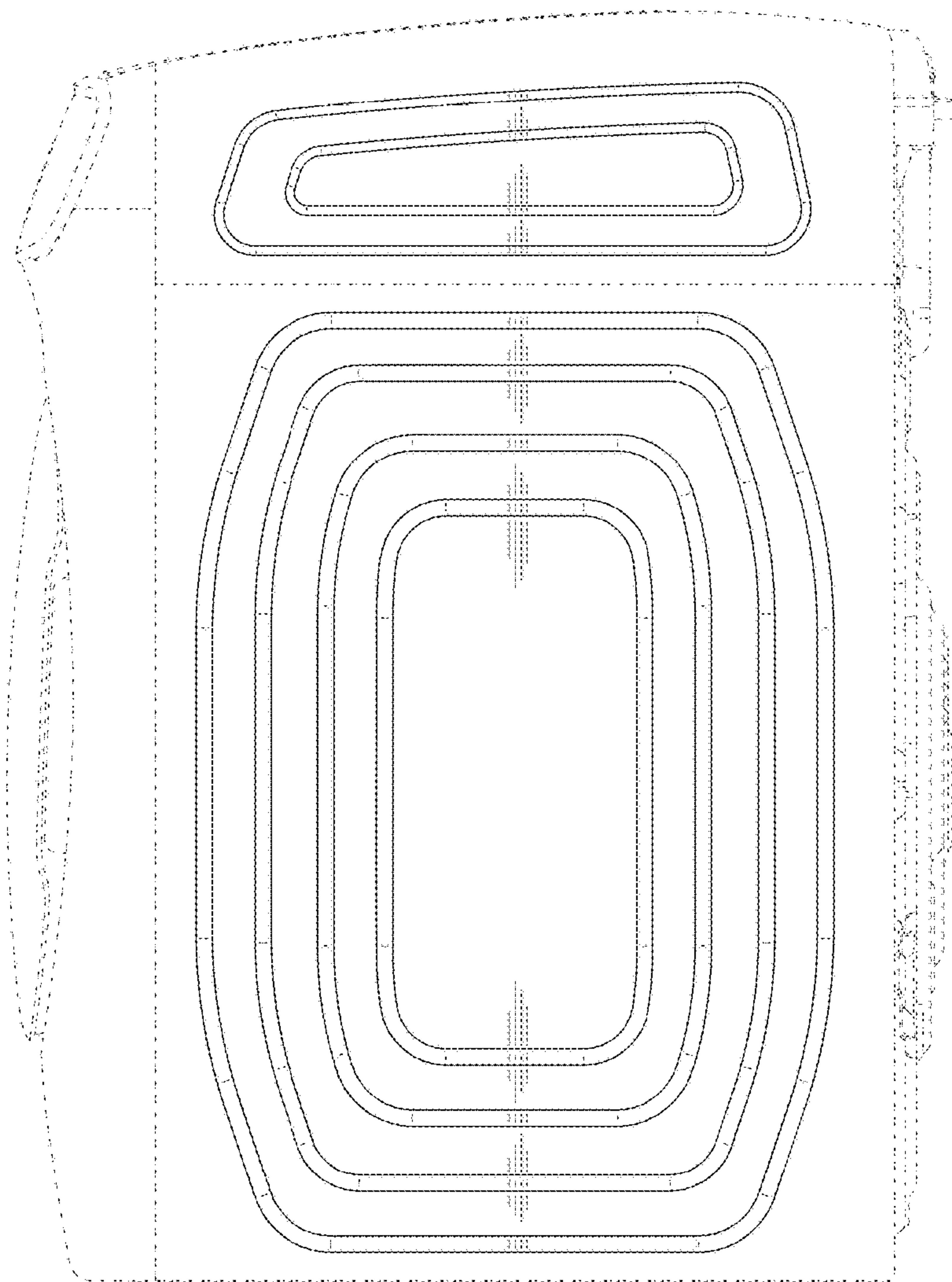

FIG. 6

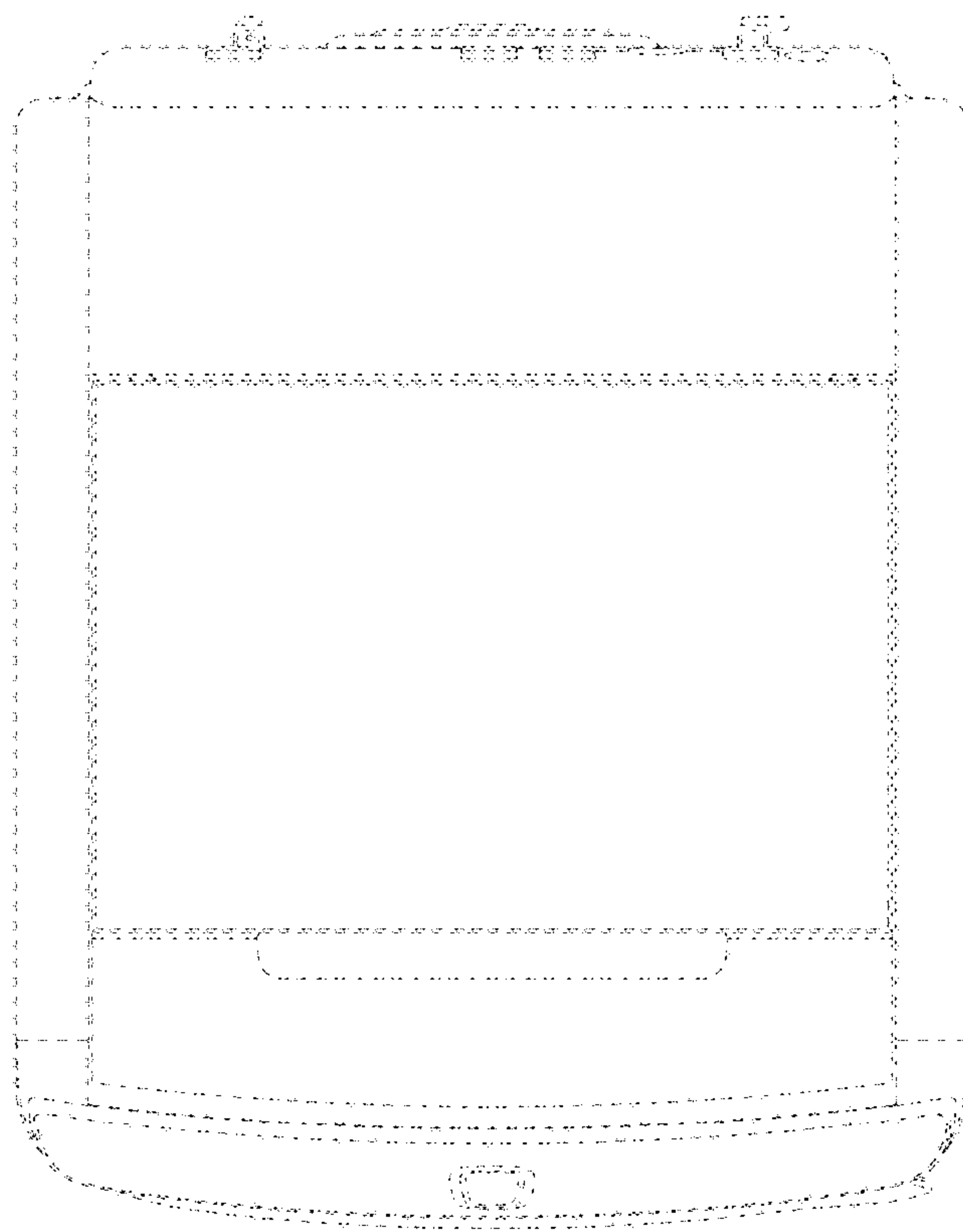

FIG. 7

