



US00D849951S

(12) **United States Design Patent**
Nishiyama et al.

(10) **Patent No.:** **US D849,951 S**

(45) **Date of Patent:** **** May 28, 2019**

(54) **SPHYGMOMANOMETER**

(71) Applicant: **OMRON HEALTHCARE Co., Ltd.**,
Muko-shi, Kyoto (JP)

(72) Inventors: **Kengo Nishiyama**, Muko (JP);
Tsuyoshi Ogihara, Muko (JP);
Yoshikazu Inami, Muko (JP); **Asa**
Hirasawa, Muko (JP)

(73) Assignee: **OMRON HEALTHCARE Co., Ltd.**,
Kyoto (JP)

(**) Term: **15 Years**

(21) Appl. No.: **29/633,984**

(22) Filed: **Jan. 17, 2018**

(30) **Foreign Application Priority Data**

Jul. 27, 2017 (JP) 2017-016228

(51) **LOC (11) Cl.** **24-02**

(52) **U.S. Cl.**
USPC **D24/165**

(58) **Field of Classification Search**
USPC D24/165–168, 186, 187; D10/75, 70, 98
CPC A61B 5/0402; A61B 5/0404; A61B 5/021;
A61B 5/024; A61B 5/02438; A61B
5/681; A61B 2560/0205; A61B
2560/0462

See application file for complete search history.

(56) **References Cited**

U.S. PATENT DOCUMENTS

D373,419 S * 9/1996 Muramatsu D24/165
D641,880 S * 7/2011 Noguchi D24/165

D690,815 S * 10/2013 Uozumi D24/165
D720,073 S * 12/2014 Shibata D24/165
D739,940 S * 9/2015 Uozumi D24/165
D744,656 S * 12/2015 Schempp D24/165
D811,596 S * 2/2018 Verbrugge D24/164
D811,597 S * 2/2018 Verbrugge D24/165

* cited by examiner

Primary Examiner — Anhdao Doan

(74) *Attorney, Agent, or Firm* — Capitol City TechLaw

(57) **CLAIM**

The ornamental design for a sphygmomanometer, as shown and described.

DESCRIPTION

FIG. 1 is a front, bottom, and right side perspective view taken from a first view angle of a sphygmomanometer showing our new design;

FIG. 2 is a front, bottom, and right side perspective view taken from a second view angle thereof;

FIG. 3 is a front view thereof;

FIG. 4 is a rear view thereof;

FIG. 5 is a top view thereof;

FIG. 6 is a bottom view thereof;

FIG. 7 is a right side view thereof; and,

FIG. 8 is a left side view thereof.

The broken lines shown in the figures illustrate portions of the sphygmomanometer that form no part of the claimed design.

1 Claim, 8 Drawing Sheets

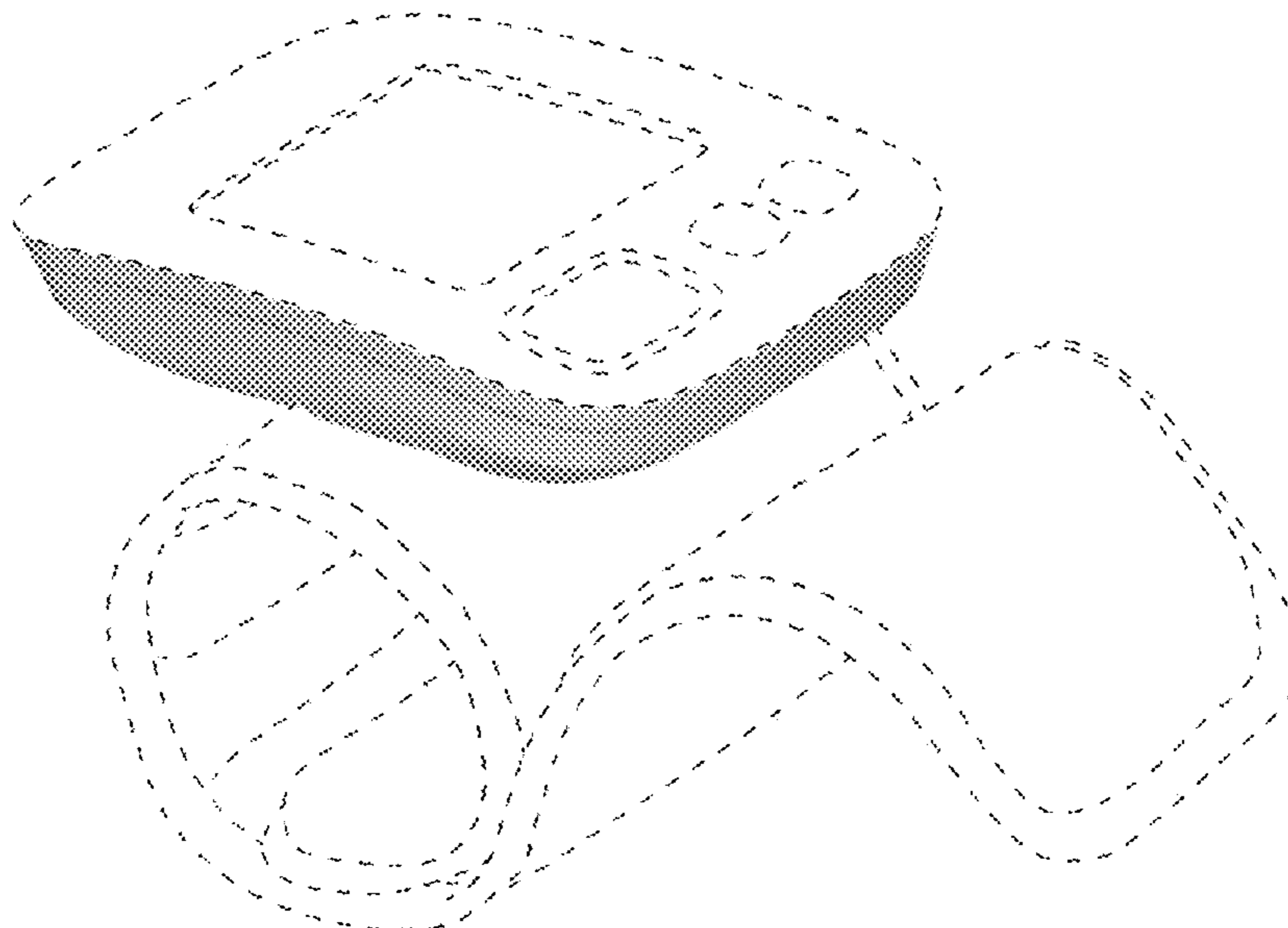

Fig. 1

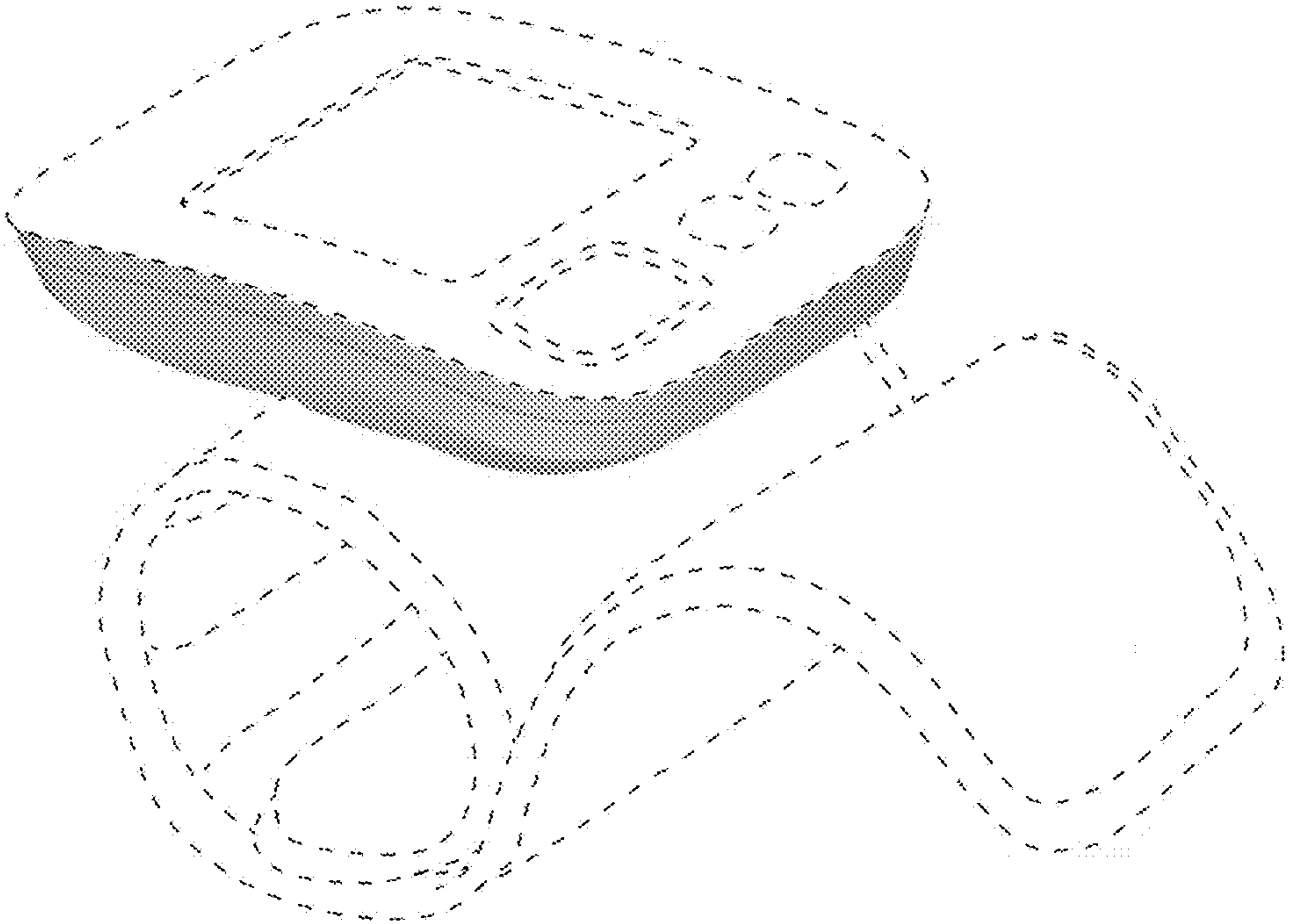

Fig.2

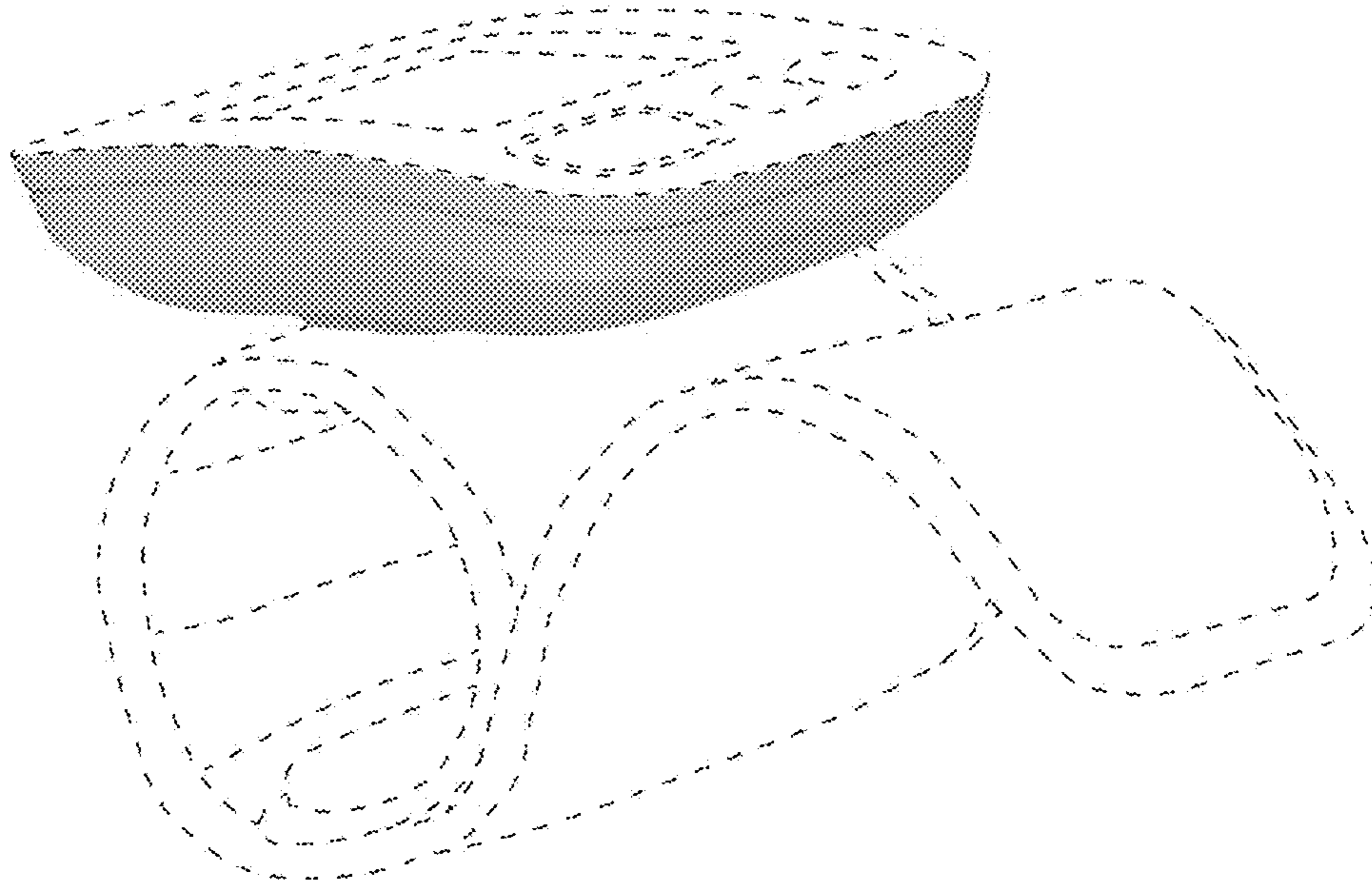

Fig.3

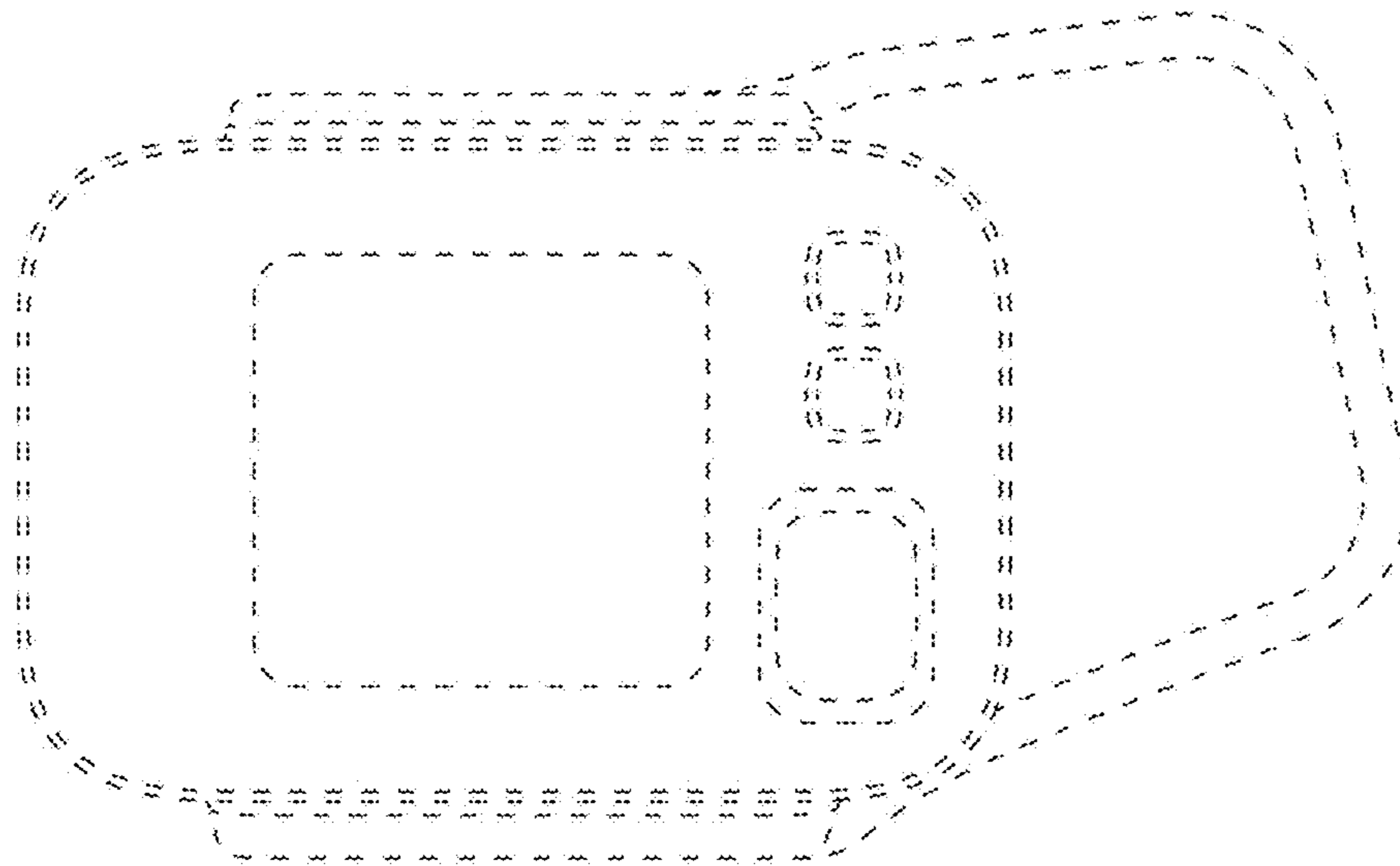

Fig.4

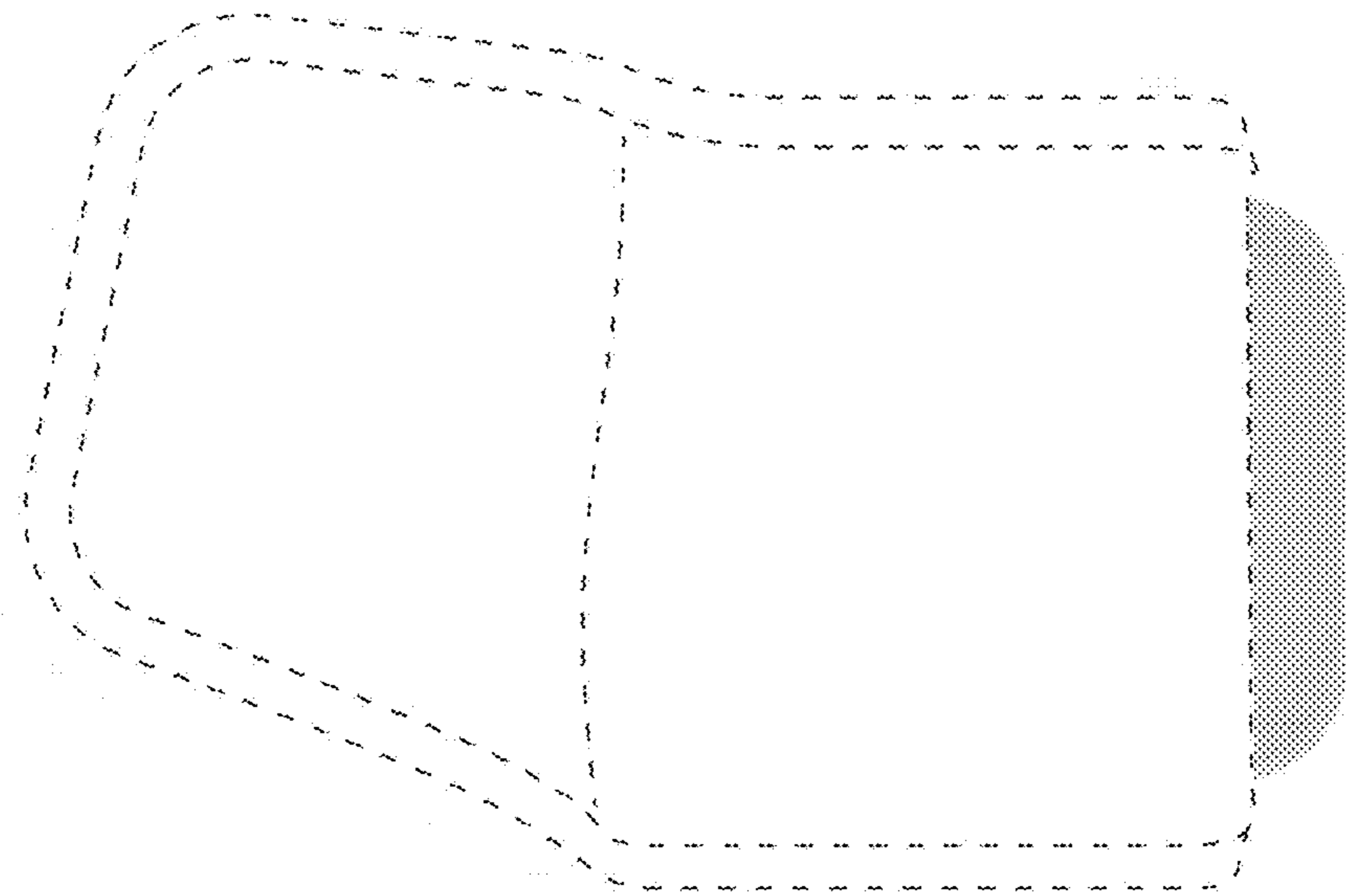

Fig.5

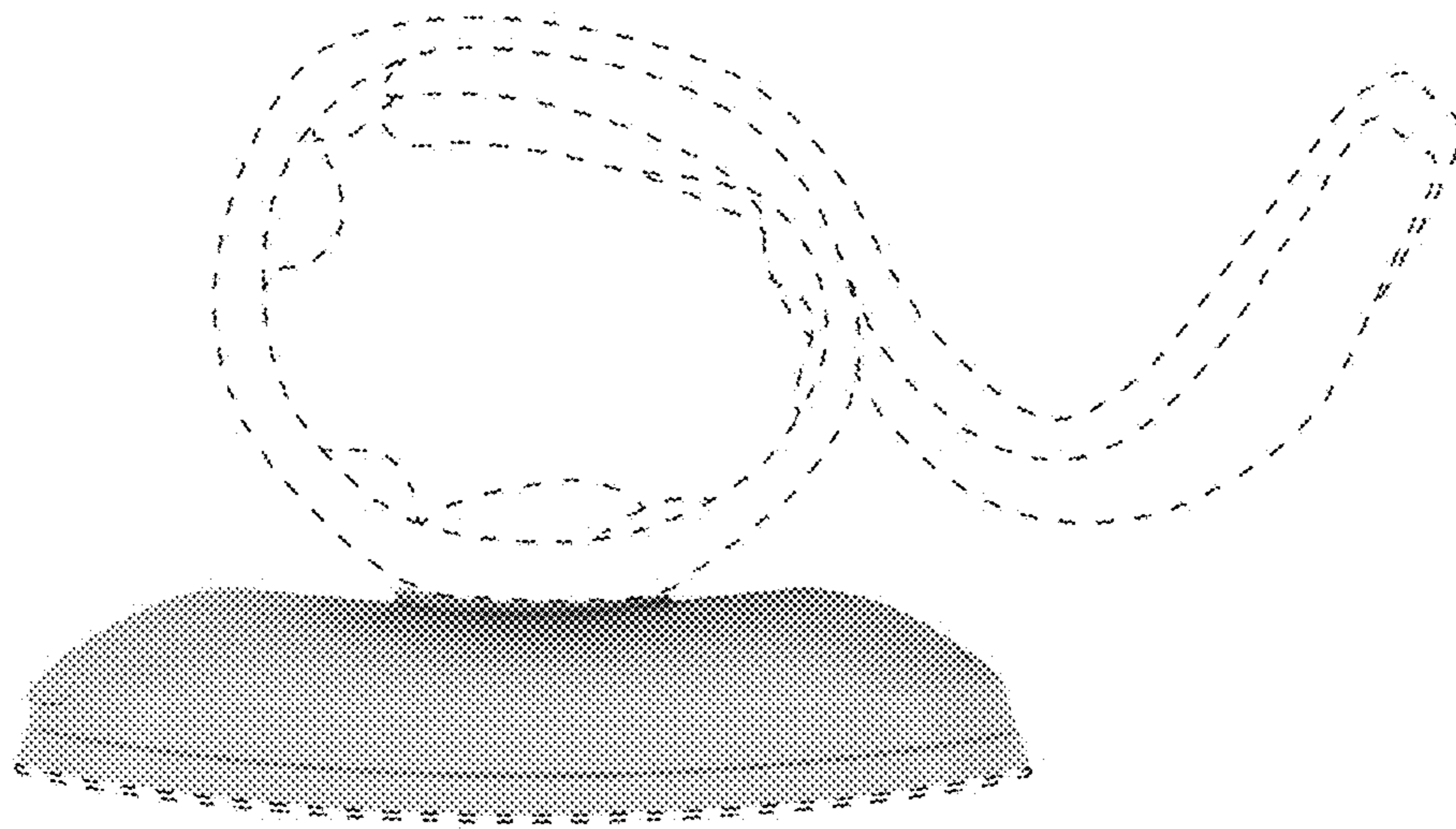

Fig.6

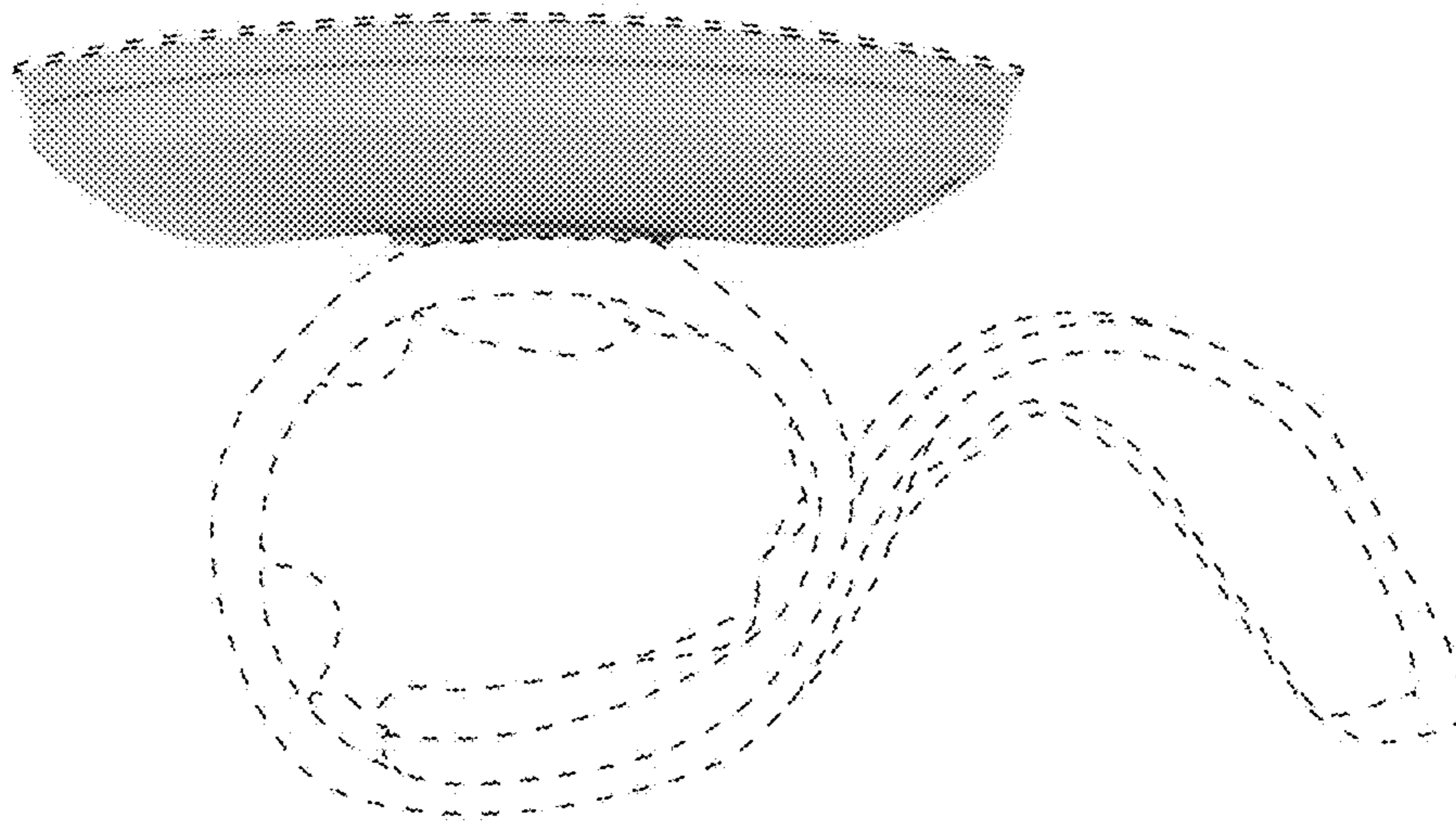

Fig.7

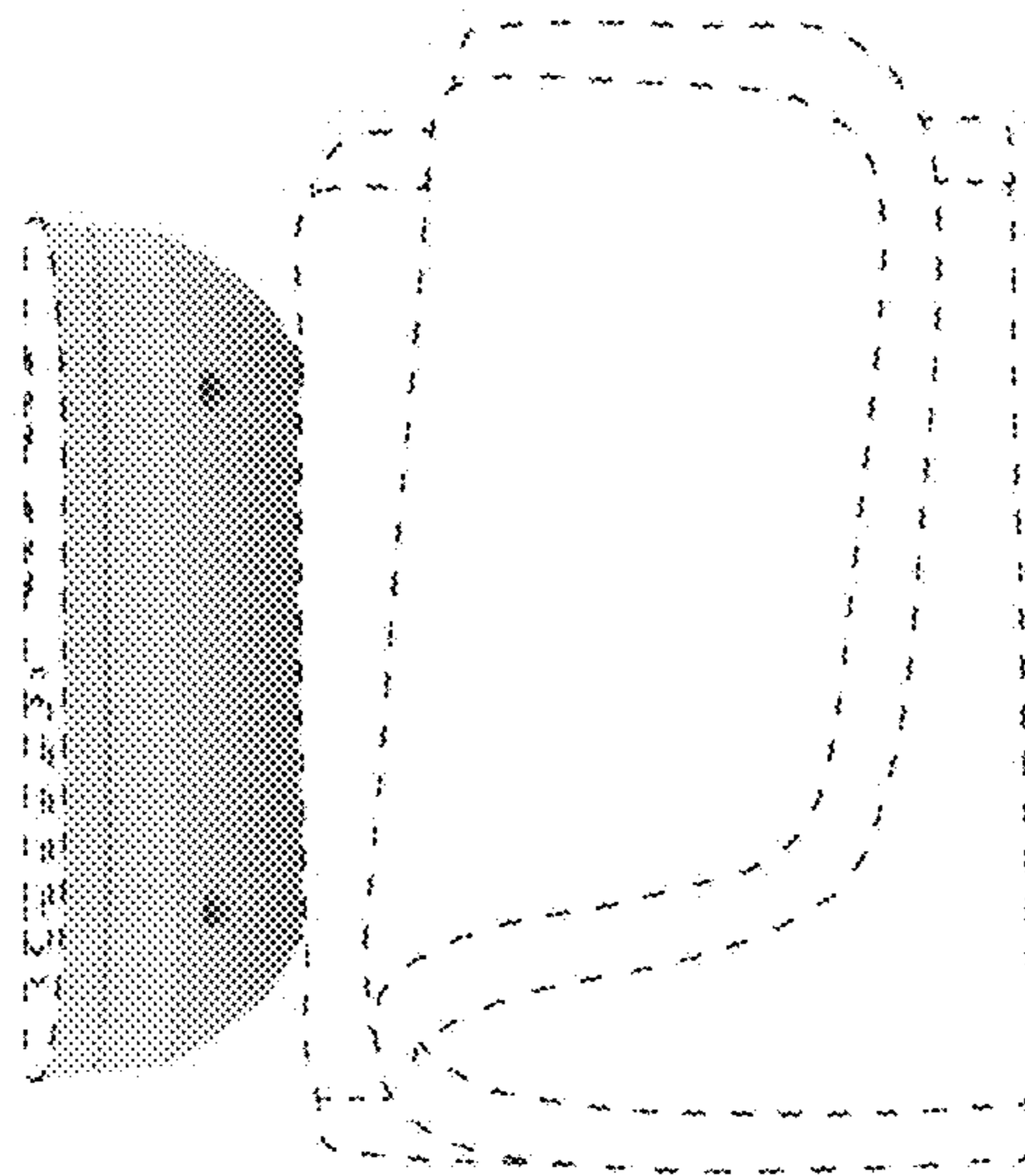

Fig.8

