



US00D849841S

(12) **United States Design Patent** (10) **Patent No.:** **US D849,841 S**  
**He et al.** (45) **Date of Patent:** **\*\* May 28, 2019**

(54) **METERED DOSE INHALER LABEL**

(71) Applicant: **Armstrong Pharmaceuticals Inc.**,  
Canton, MA (US)

(72) Inventors: **Ping He**, Sharon, MA (US); **Lei Zhou**,  
Canton, MA (US); **Kevin Rego**,  
Canton, MA (US)

(73) Assignee: **Armstrong Pharmaceuticals Inc.**,  
Canton, MA (US)

(\*\*) Term: **15 Years**

(21) Appl. No.: **29/640,980**

(22) Filed: **Mar. 19, 2018**

(51) **LOC (11) Cl.** ..... **19-08**

(52) **U.S. Cl.**  
USPC ..... **D20/22**

(58) **Field of Classification Search**  
USPC ..... D20/10, 11, 22, 23, 24, 25, 26, 27, 28,  
D20/29, 40, 99; D9/434, 457; D19/1, 4;  
D24/110, 189  
CPC ..... G09F 2003/0239; G09F 2003/0251; G09F  
2003/0272  
See application file for complete search history.

(56) **References Cited**

**U.S. PATENT DOCUMENTS**

2,732,063	A *	1/1956	Dedek	.....	B65D 65/10 206/410
D405,118	S *	2/1999	Murphy, Sr.	.....	D20/11
D461,239	S *	8/2002	Cassidy	.....	D24/110
D471,984	S *	3/2003	Dunshee	.....	D24/189
D552,180	S *	10/2007	Kim	.....	D20/27
7,594,348	B2 *	9/2009	Oosterlinck	.....	G09F 3/0289 229/102
D627,001	S *	11/2010	de Niet	.....	D20/22
8,800,182	B2 *	8/2014	Hung	.....	G09F 3/04 281/2
D749,677	S *	2/2016	El-Afandi	.....	D20/22

D750,175	S *	2/2016	El-Afandi	.....	D20/22
D750,176	S *	2/2016	El-Afandi	.....	D20/22
9,355,578	B2 *	5/2016	El-Afandi	.....	G09F 3/0288
D772,395	S *	11/2016	Walsh	.....	D24/110
9,643,771	B2 *	5/2017	Adler	.....	G09F 3/0289
9,773,433	B2 *	9/2017	Kerkar	.....	A24D 1/02
9,798,861	B2 *	10/2017	Adler	.....	G09F 3/0289
9,842,517	B1 *	12/2017	Amami	.....	G09F 3/005
9,865,183	B2 *	1/2018	Dorvil	.....	G09F 3/10

(Continued)

**OTHER PUBLICATIONS**

“FDA approves return of popular Primatene Mist asthma inhaler”  
Found online Dec. 14, 2018 at startribune.com. Page dated Nov. 8,  
2018. Retrieved from <http://www.startribune.com/fda-approves-return-of-popular-primatene-mist-asthma-inhaler/500058911/> (Year:  
2018).\*

(Continued)

*Primary Examiner* — George D. Kirschbaum

*Assistant Examiner* — Sloan Rozin

(74) *Attorney, Agent, or Firm* — Lewis Roca Rothgerber  
Christie LLP

(57) **CLAIM**

The ornamental design for metered dose inhaler label, as  
shown and described.

**DESCRIPTION**

FIG. 1 is perspective view of a metered dose inhaler label of  
our design;  
FIG. 2 is a left side view thereof;  
FIG. 3 is a back view thereof;  
FIG. 4 is a right side view thereof;  
FIG. 5 is a front view thereof;  
FIG. 6 is a top view thereof; and,  
FIG. 7 is a bottom view thereof.  
The broken lines in the drawings illustrate environmental  
structure that forms no part of the claimed design.

**1 Claim, 4 Drawing Sheets**

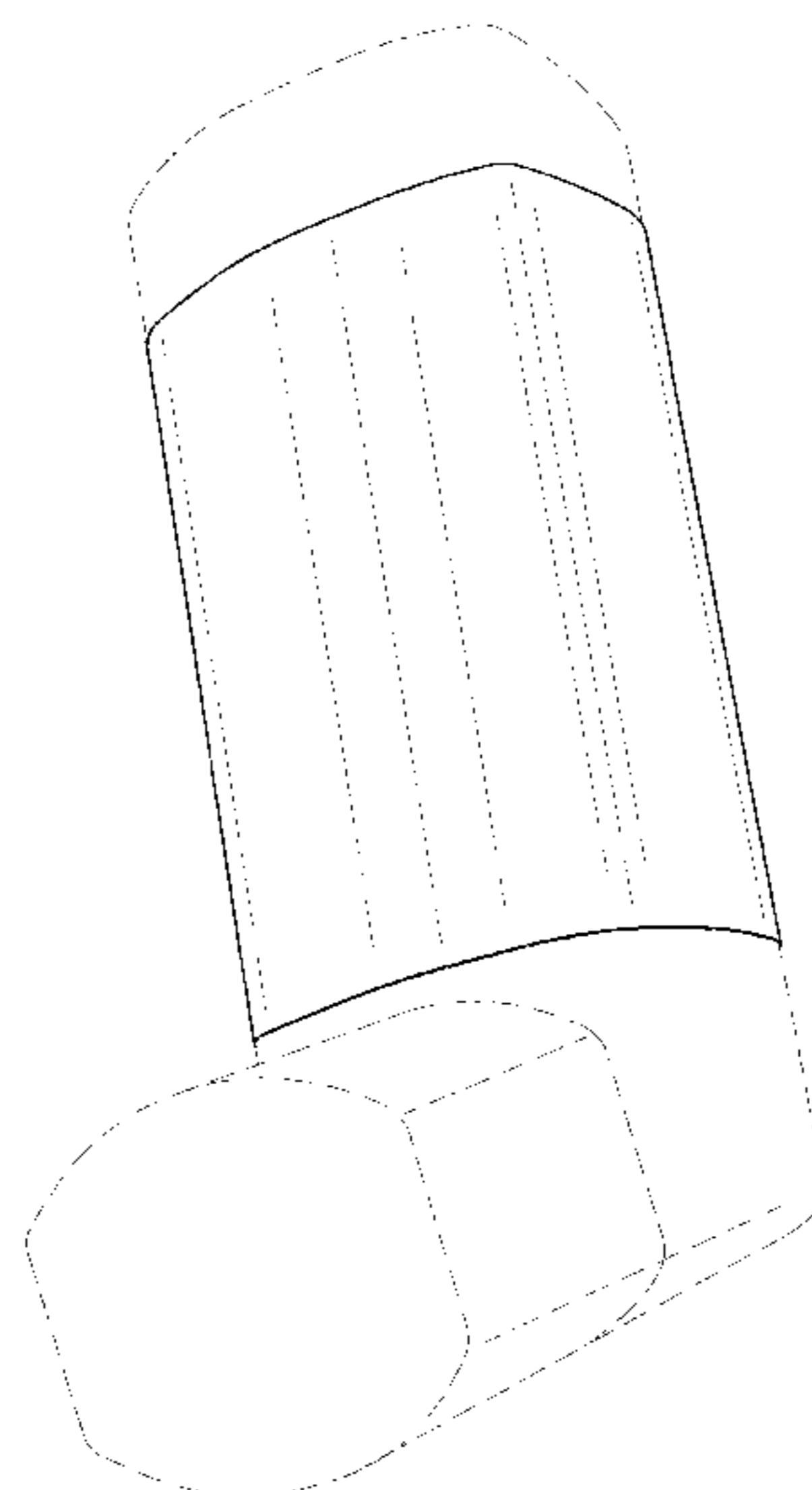

(56)

**References Cited**

U.S. PATENT DOCUMENTS

D812,761 S \* 3/2018 Heni ..... D24/189  
9,934,704 B2 \* 4/2018 Perin ..... G09F 3/0297  
9,984,596 B2 \* 5/2018 Kyogane ..... B29C 66/73921

OTHER PUBLICATIONS

“Asthma in Style” Found online Dec. 20, 2018 at [asthma.net](https://asthma.net). Page dated Jan. 23, 2017. Retrieved from <https://asthma.net/living/in-style/> (Year: 2017).\*

\* cited by examiner

FIG. 1

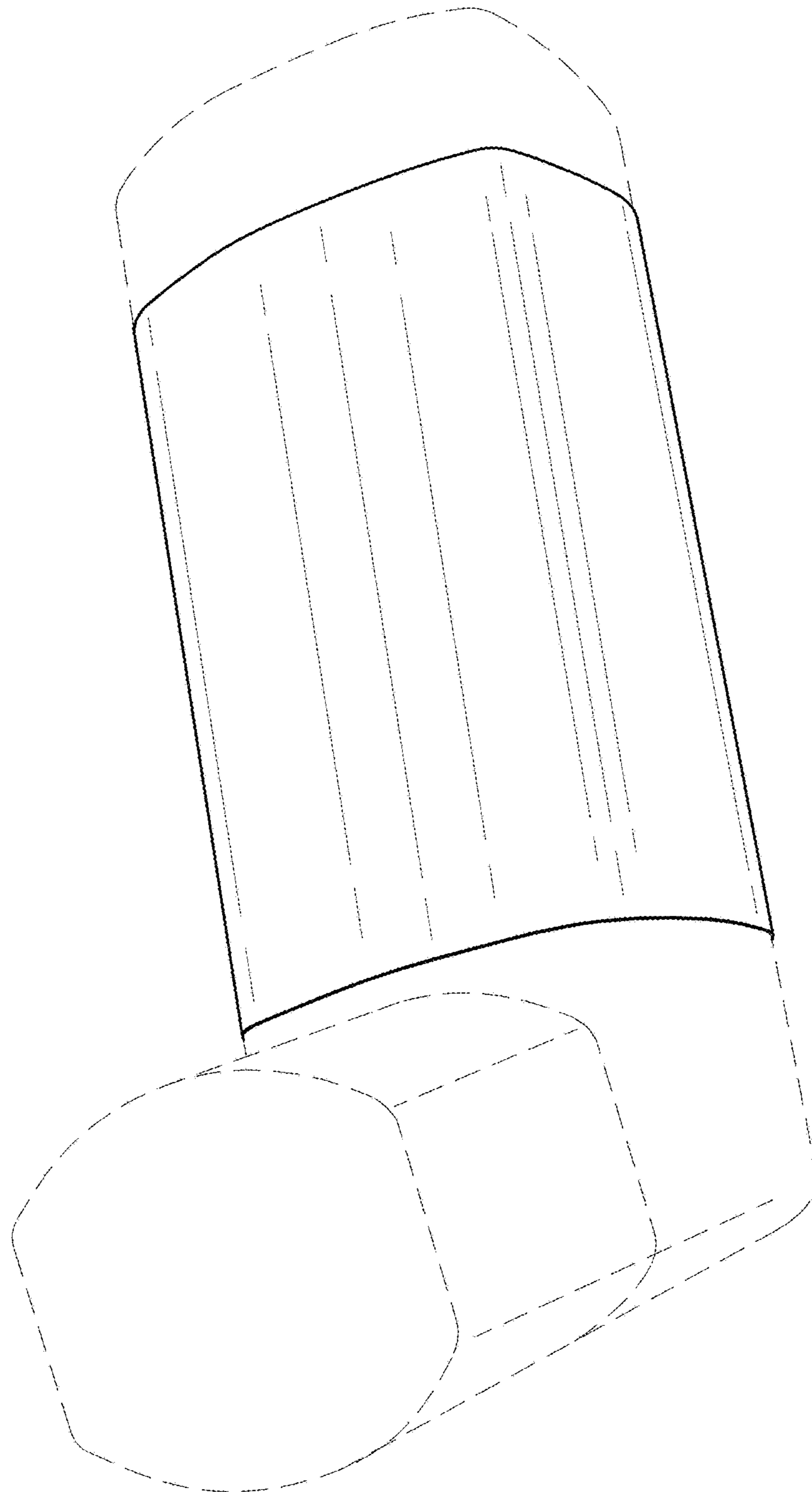

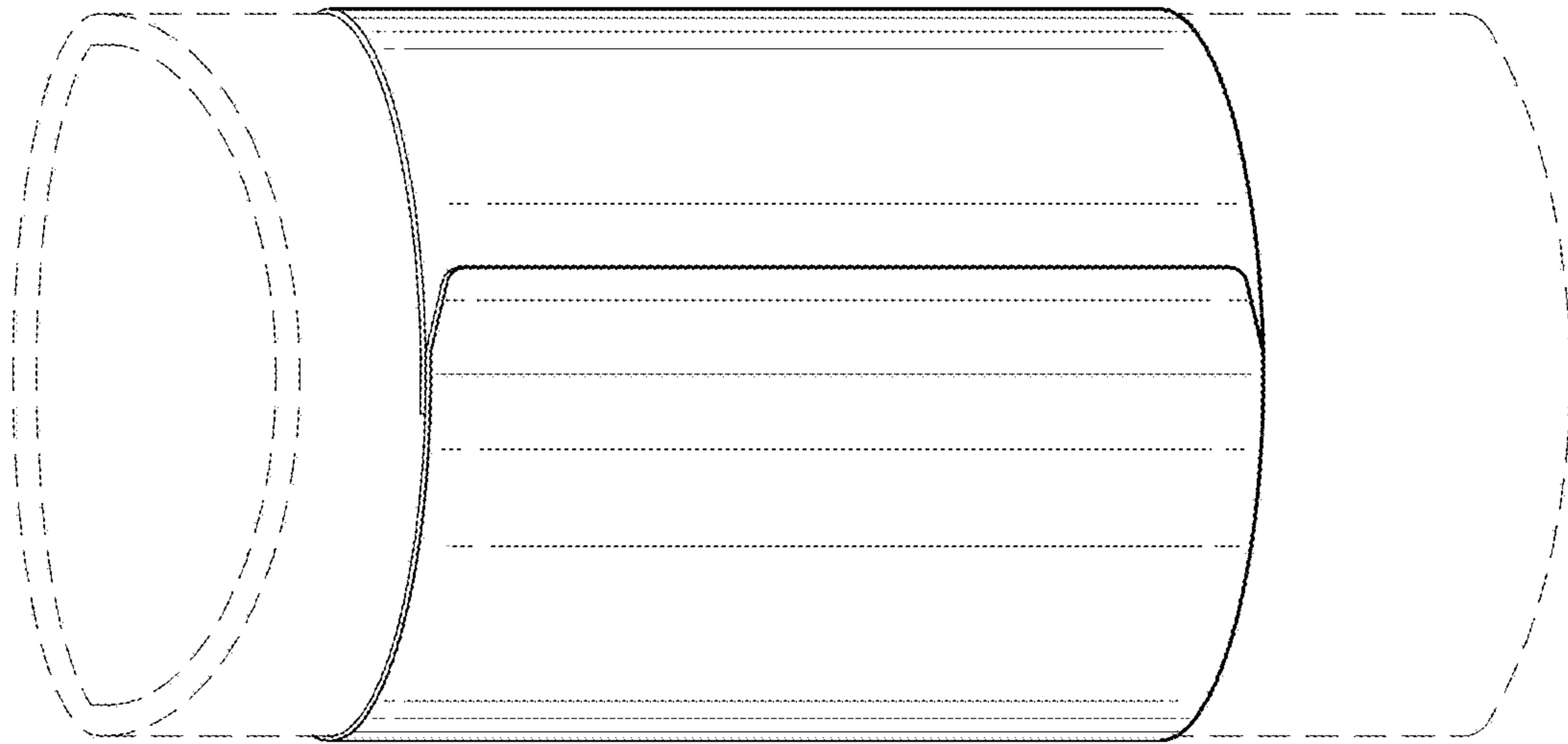

FIG. 3

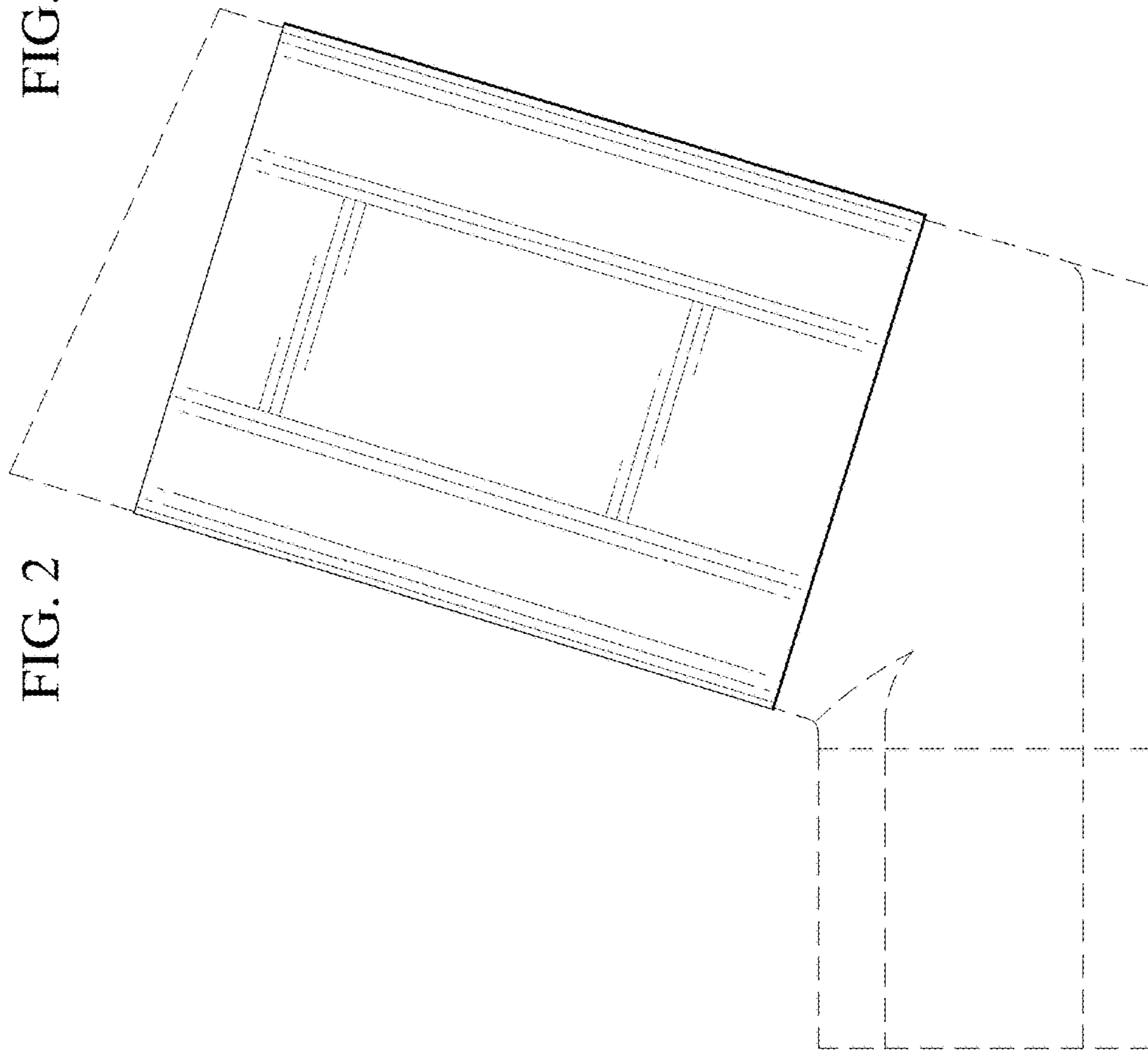

FIG. 2

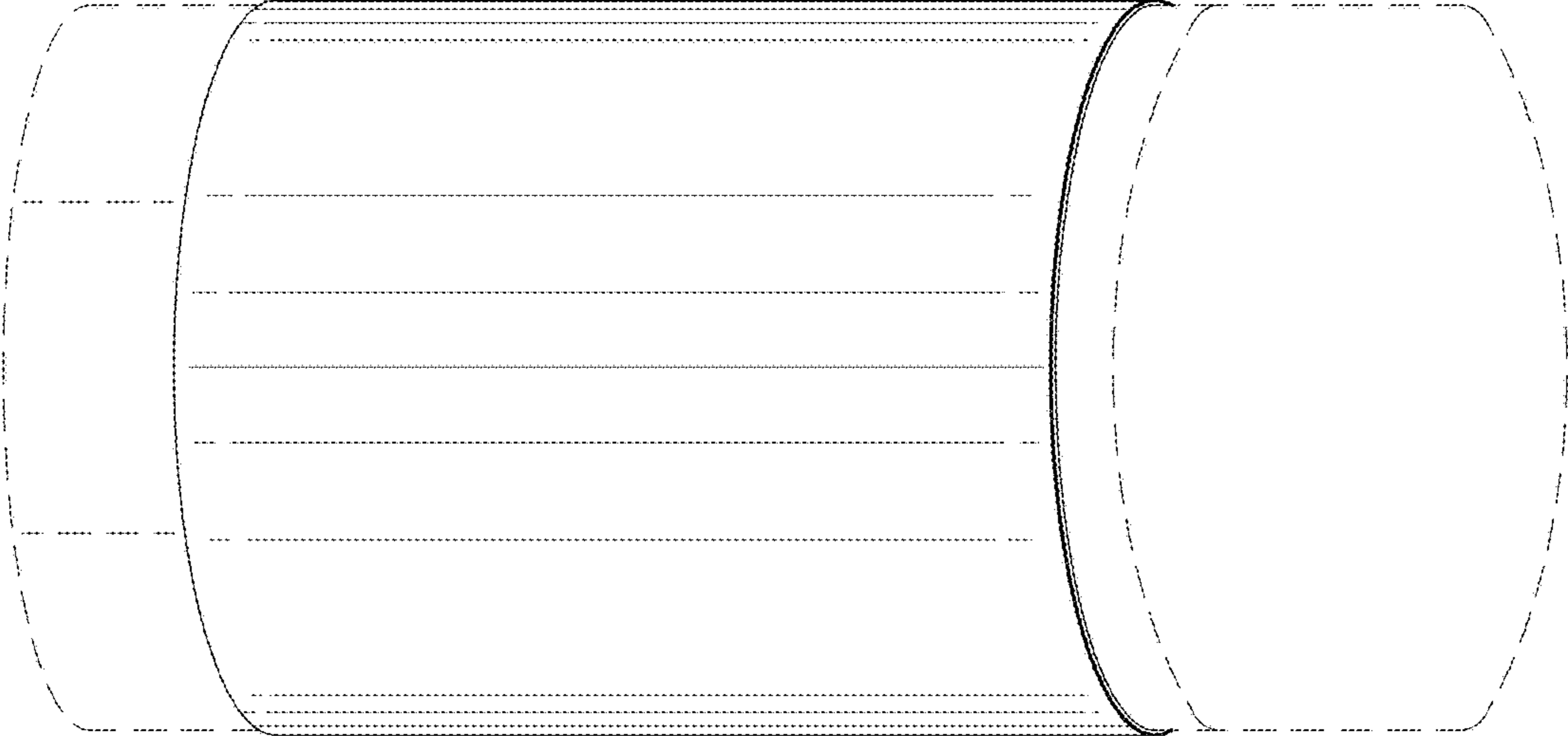

FIG. 5

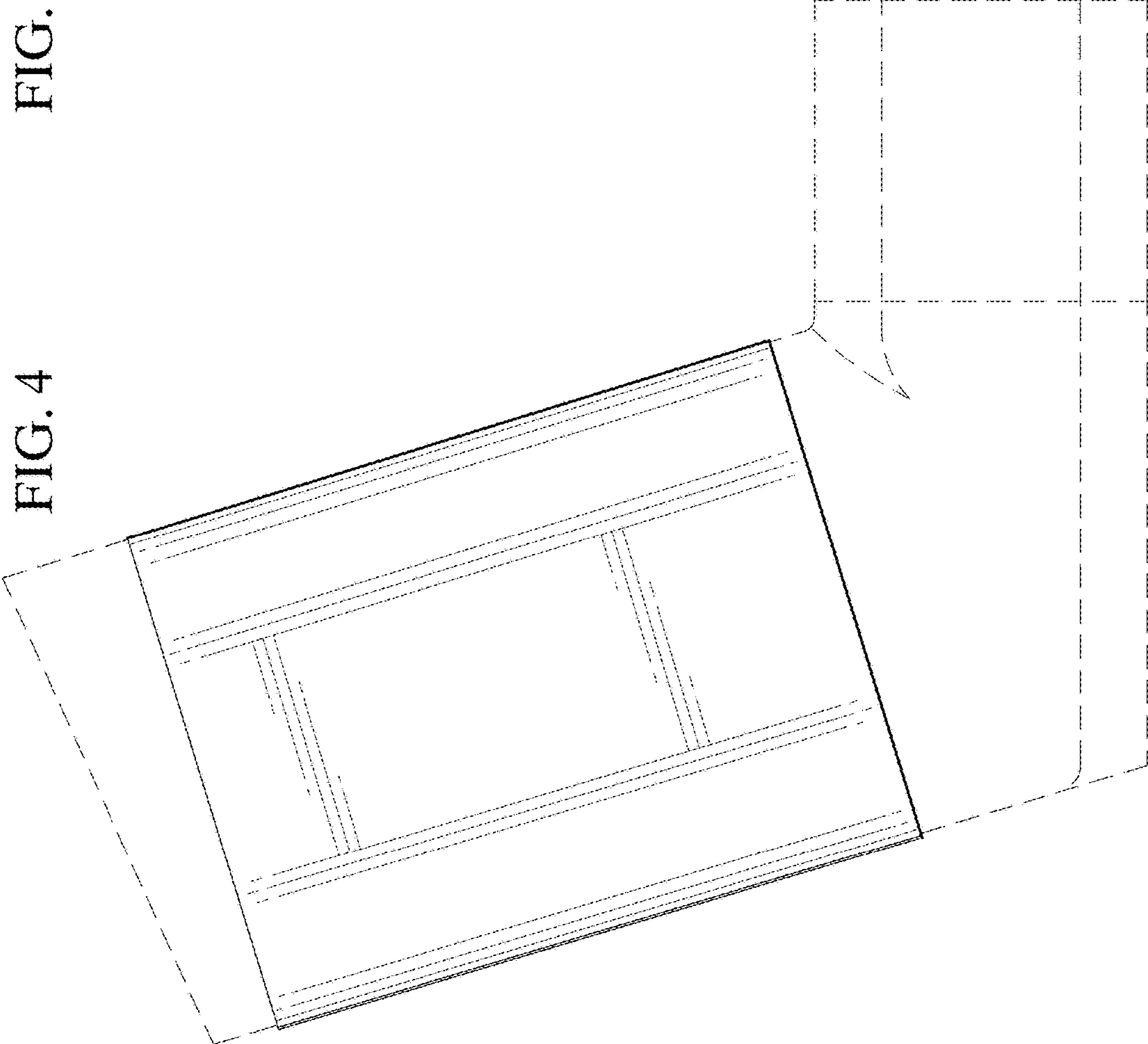

FIG. 4

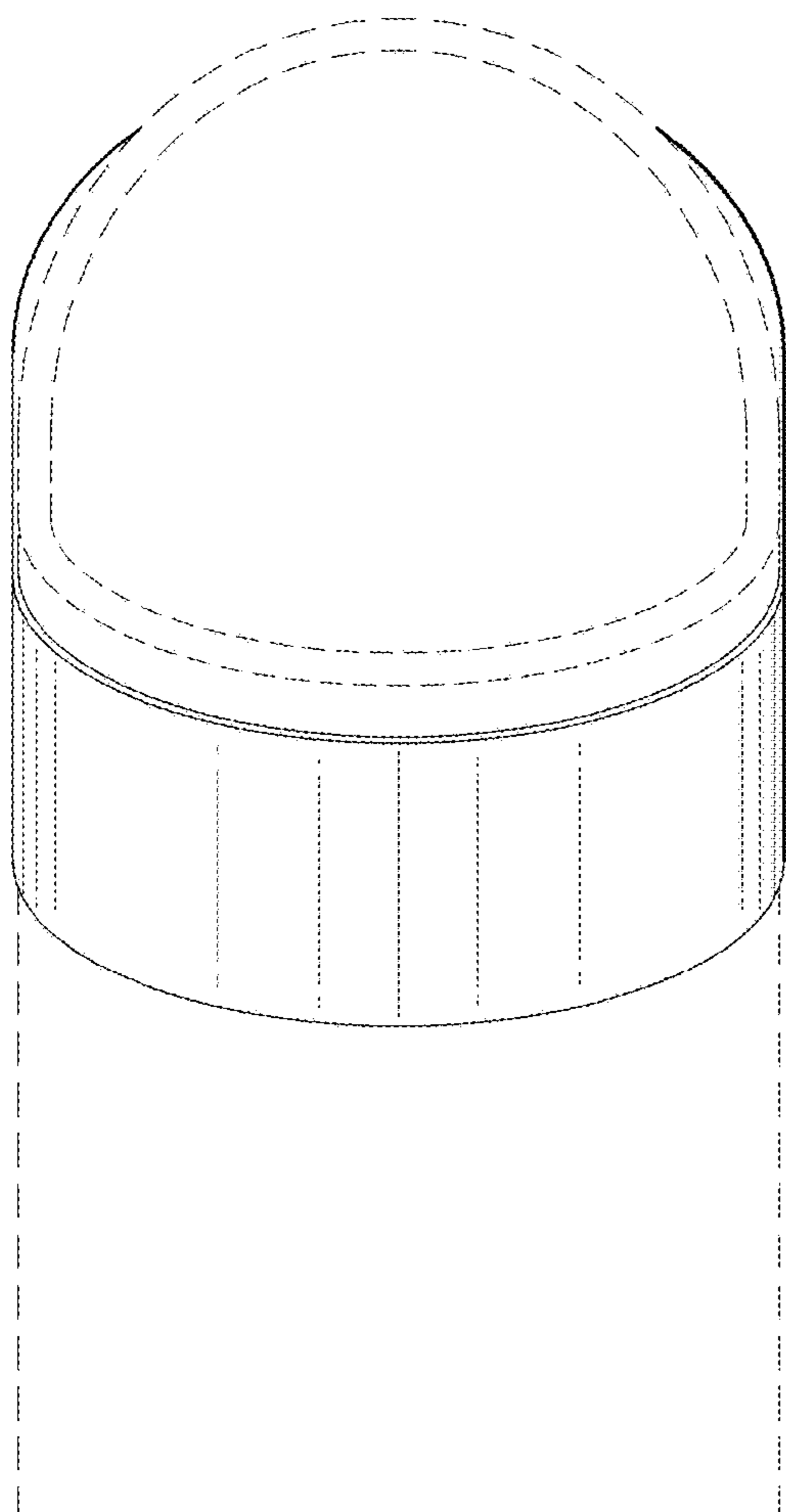

FIG. 6

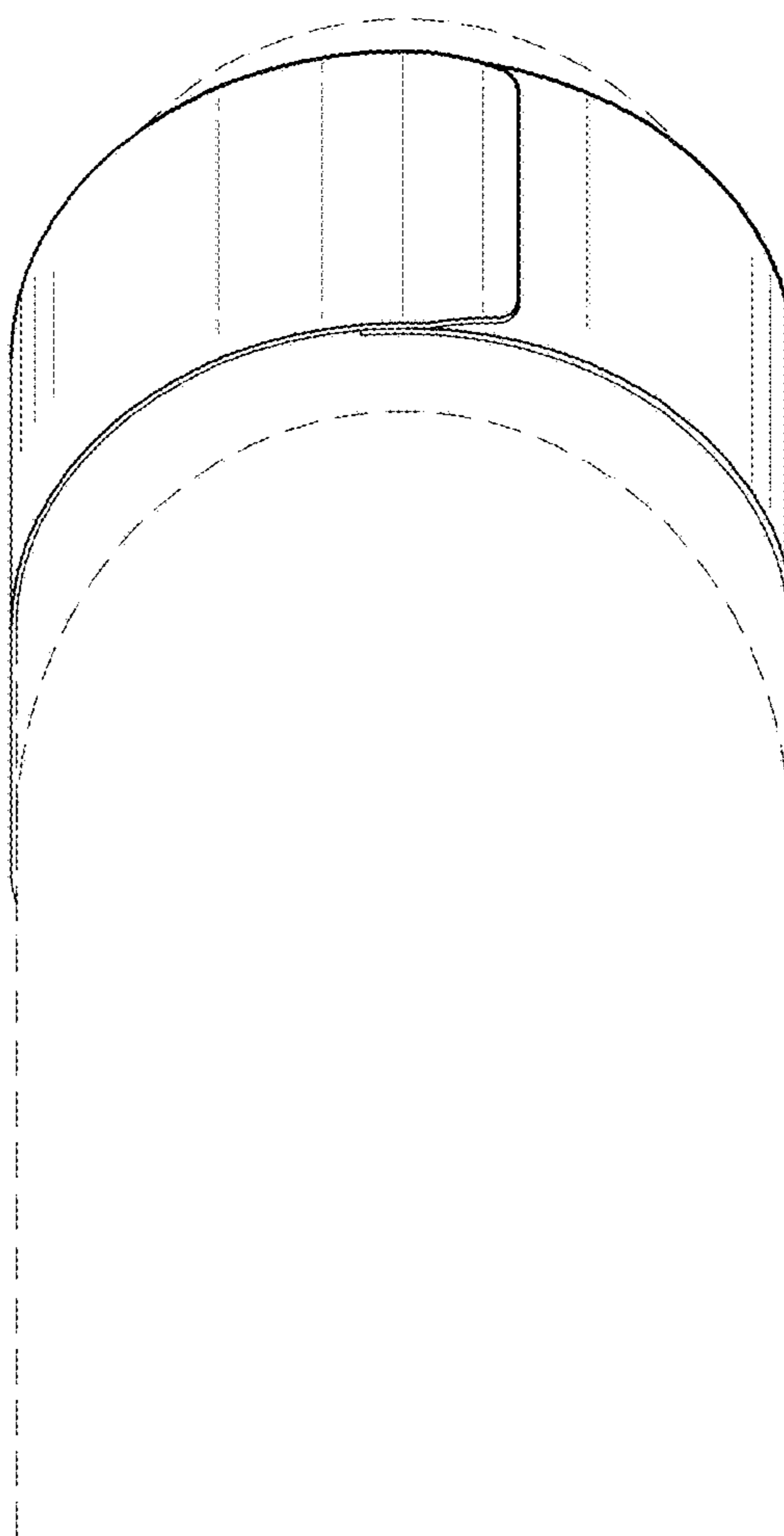

FIG. 7