



US00D849740S

(12) **United States Design Patent** (10) **Patent No.:** **US D849,740 S**  
**Malouf et al.** (45) **Date of Patent:** **\*\* May 28, 2019**

(54) **CASSETTE WITH MAGNET**  
(71) Applicant: **Cochlear Limited**, NSW (AU)  
(72) Inventors: **Christopher Malouf**, Ryde (AU);  
**Angela Lemmerz**, Macquarie Park (AU); **Matthew Cutts**, Kellyville (AU);  
**Roger Leigh**, North Epping (AU)  
(73) Assignee: **Cochlear Limited**, NSW (AU)  
(\*\*) Term: **15 Years**  
(21) Appl. No.: **29/626,618**  
(22) Filed: **Nov. 17, 2017**  
(51) **LOC (11) Cl.** ..... **14-99**  
(52) **U.S. Cl.**  
USPC ..... **D14/299**  
(58) **Field of Classification Search**  
USPC ..... D14/224-229; D16/244; D17/99;  
D6/681; 248/125.1, 166, 185.1;  
381/355, 359, 361-363, 365, 366, 369,  
381/375; 379/428.01, 428.04, 431,  
379/433.03; D10/104.1; 607/57  
CPC . H04R 25/00; H04R 1/02; H04R 5/02; H04R  
9/08; F16M 11/38; F16M 13/00; F16M  
11/00  
See application file for complete search history.

(56) **References Cited**  
U.S. PATENT DOCUMENTS  
D105,226 S \* 7/1937 Moore ..... D14/226  
5,105,811 A \* 4/1992 Kuzma ..... A61N 1/3754  
607/57  
6,648,914 B2 \* 11/2003 Berrang ..... A61N 1/36036  
600/25  
7,534,127 B2 \* 5/2009 Parker ..... A61N 1/3752  
439/425  
D629,202 S \* 12/2010 Wai ..... D3/201

D676,955 S \* 2/2013 Orome ..... D24/108  
8,454,668 B2 \* 6/2013 Asnes ..... H04R 25/606  
606/307  
8,489,195 B2 \* 7/2013 Dalton ..... A61N 1/36036  
606/300

(Continued)

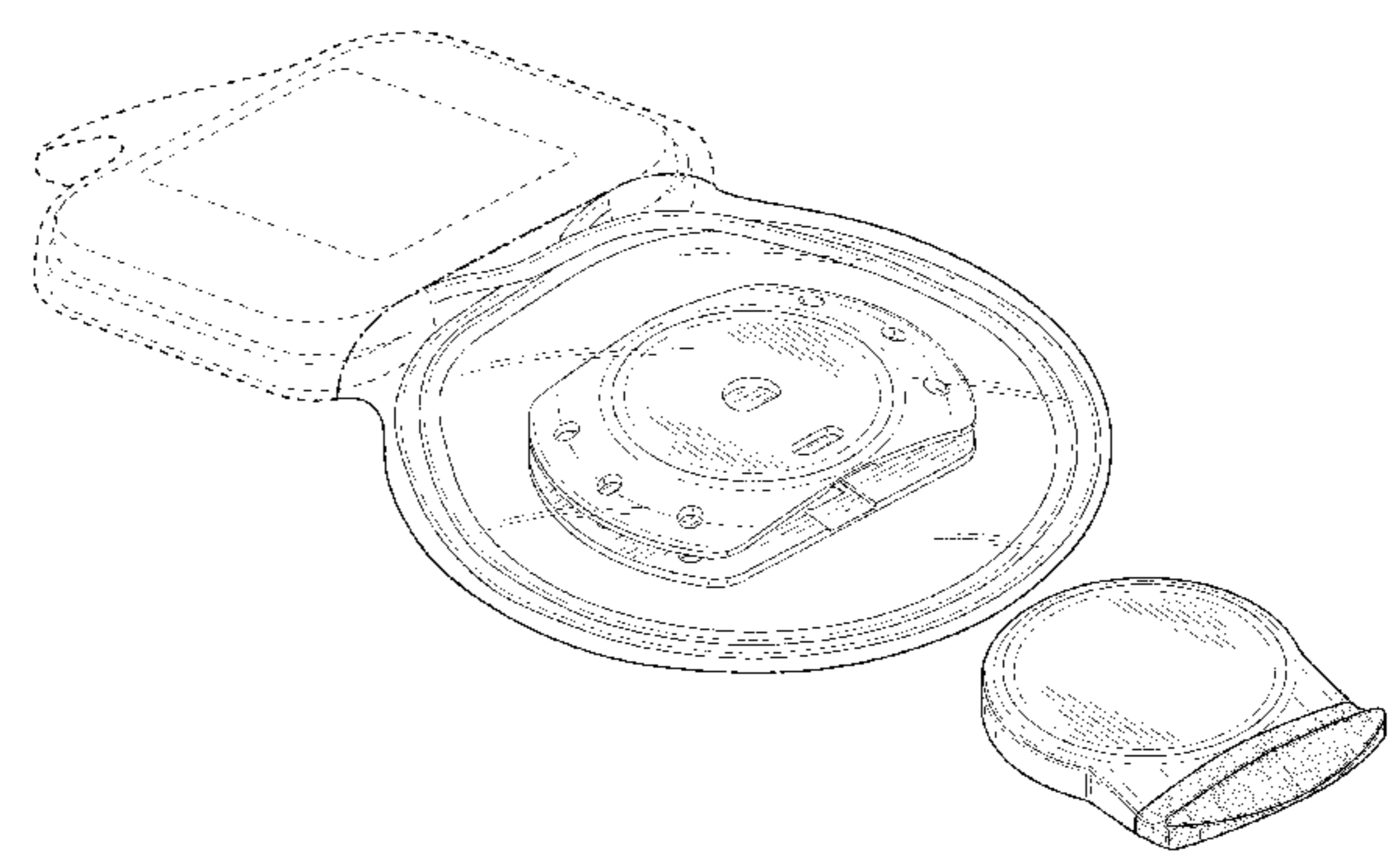
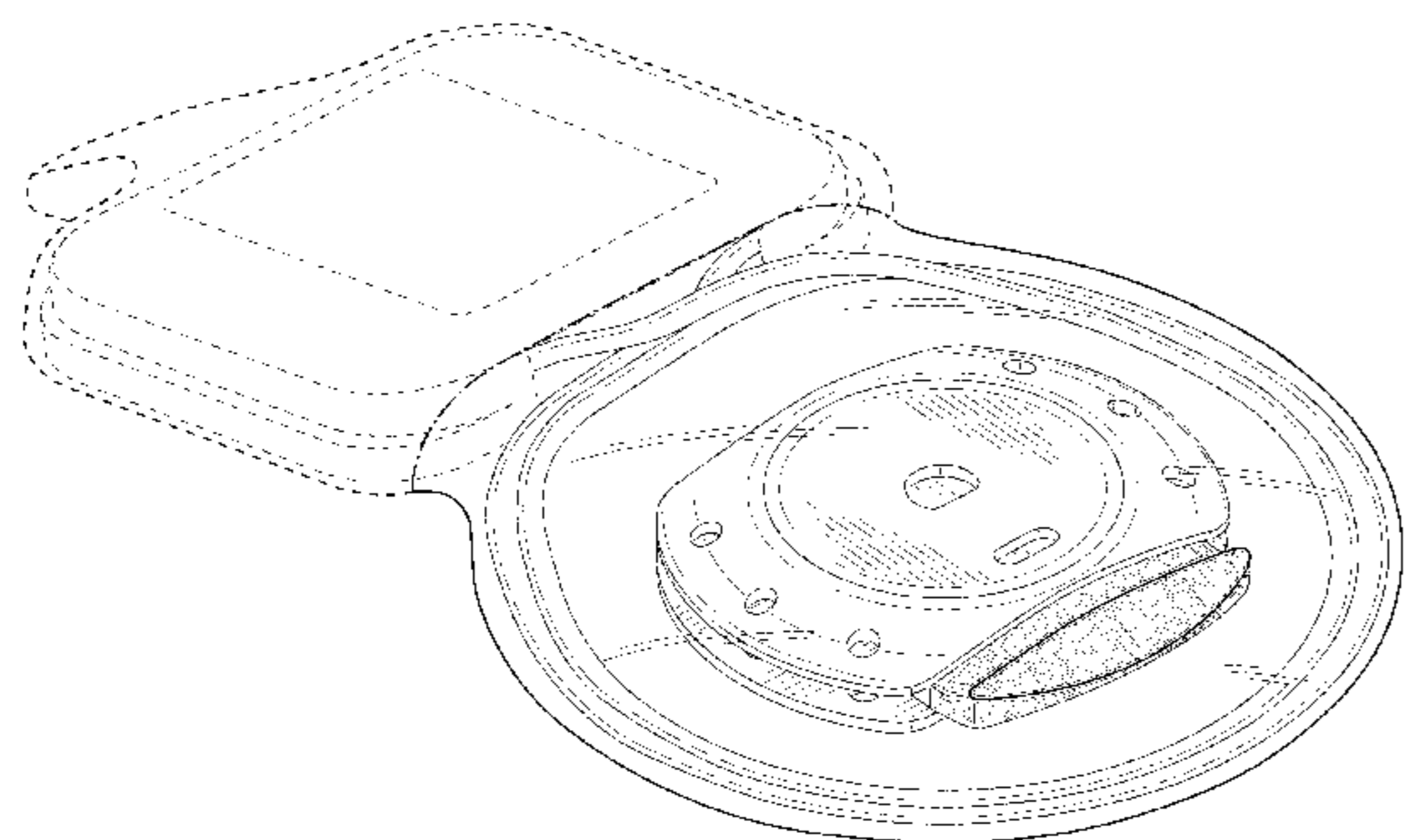
*Primary Examiner* — Katie Jane Stofko  
(74) *Attorney, Agent, or Firm* — Finnegan, Henderson,  
Farabow, Garrett & Dunner LLP

(57) **CLAIM**  
The ornamental design for cassette with magnet, as shown  
and described.

**DESCRIPTION**

FIG. 1 is a top, front, right perspective view of a cassette  
with magnet showing our new design;  
FIG. 2 is a top plan view thereof;  
FIG. 3 is a bottom plan view thereof with a portion of the  
unclaimed subject matter removed to show the interior coil;  
FIG. 4 is a left side view thereof;  
FIG. 5 is a right side view thereof;  
FIG. 6 is a front elevation view thereof;  
FIG. 7 is rear elevation view thereof;  
FIG. 8 is a top, front, right perspective view thereof in an  
alternate configuration with the magnet in a removed posi-  
tion;  
FIG. 9 is a top plan view of the magnet;  
FIG. 10 is a bottom plan view of the magnet;  
FIG. 11 is a right side view of the magnet, with the left side  
view being a mirror image thereof;  
FIG. 12 is a front elevation view of the magnet; and,  
FIG. 13 is a rear elevation view of the magnet.  
The uneven length broken lines illustrate the boundary of the  
claimed design, and form no part thereof. The even length  
broken lines shown in the drawings illustrate portions of the  
cassette with magnet that form no part of the claimed design.  
Contrast in materials in FIGS. 1-13 is shown using line  
shading on some surfaces and stippling shading on others.

**1 Claim, 13 Drawing Sheets**



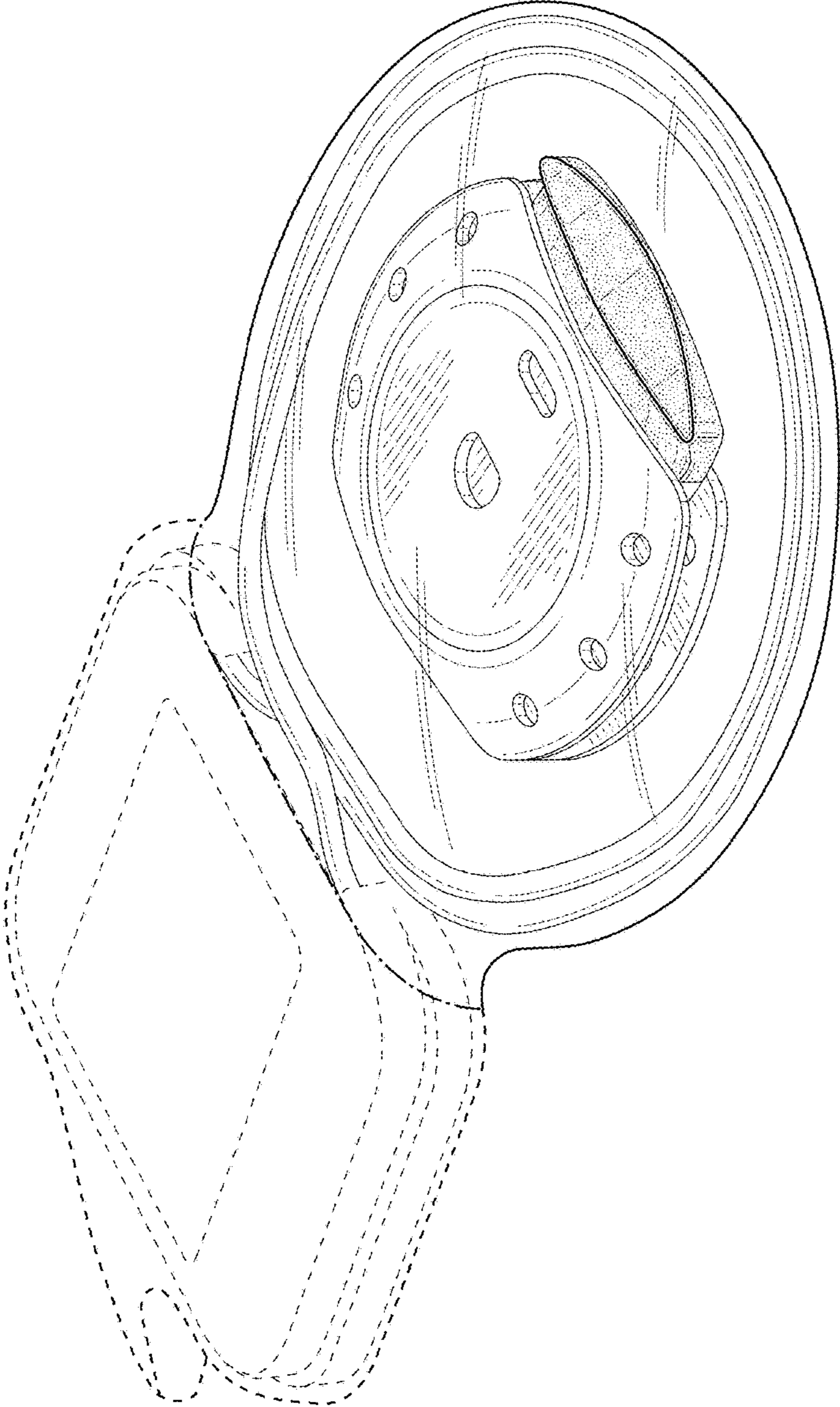
(56)

**References Cited**

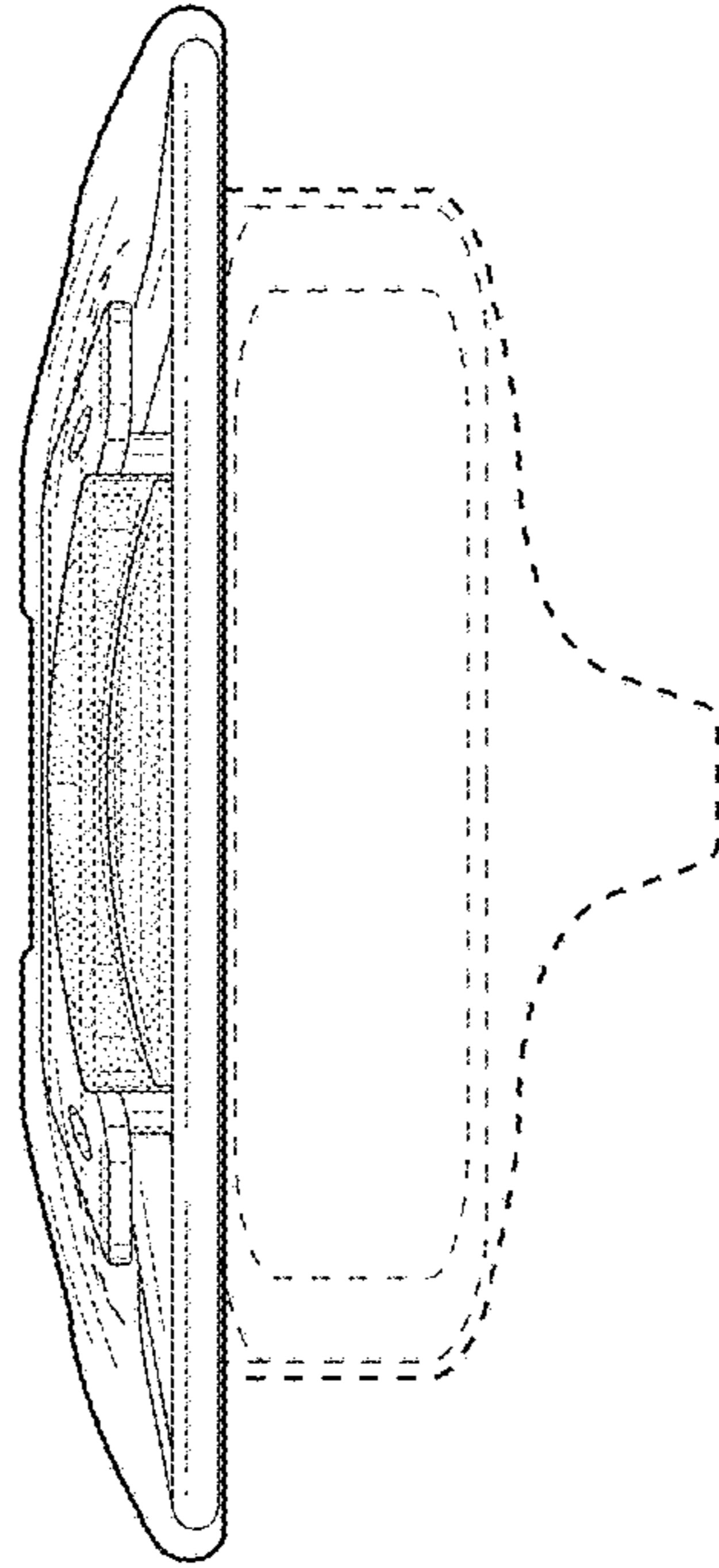
U.S. PATENT DOCUMENTS

8,532,783 B2 \* 9/2013 Zimmerling ..... A61N 1/375  
607/57  
8,771,166 B2 \* 7/2014 Conn ..... H04R 25/405  
600/25  
8,950,715 B2 \* 2/2015 Chiu ..... F16M 11/041  
248/126  
D760,392 S \* 6/2016 Jurkiewicz ..... D24/174  
10,097,934 B2 \* 10/2018 Meskens ..... H04R 25/606

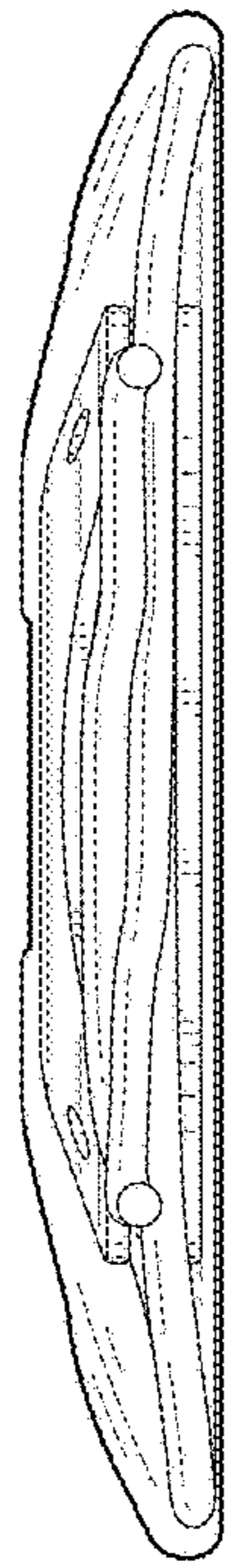
\* cited by examiner



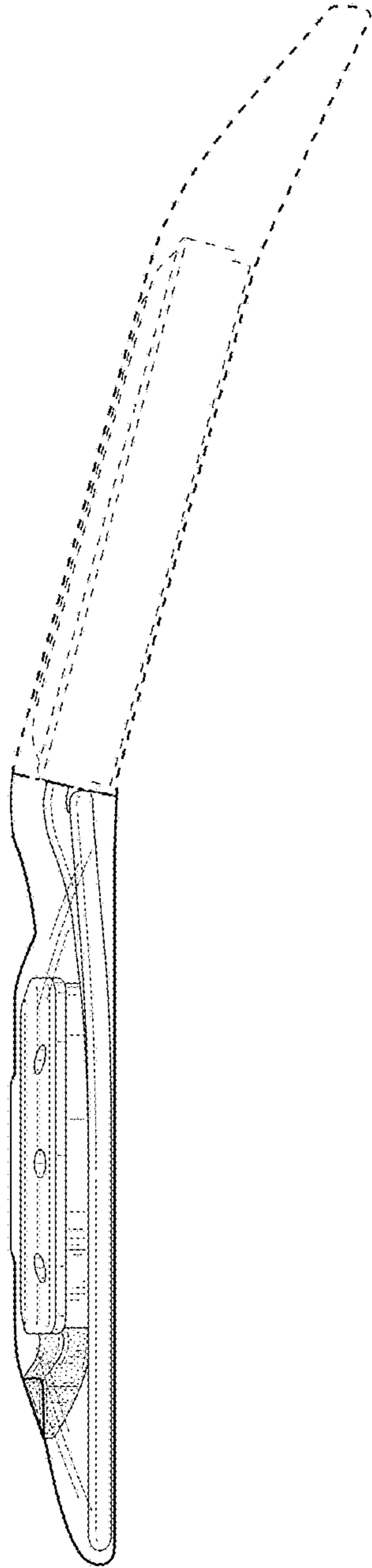
**FIG. 1**



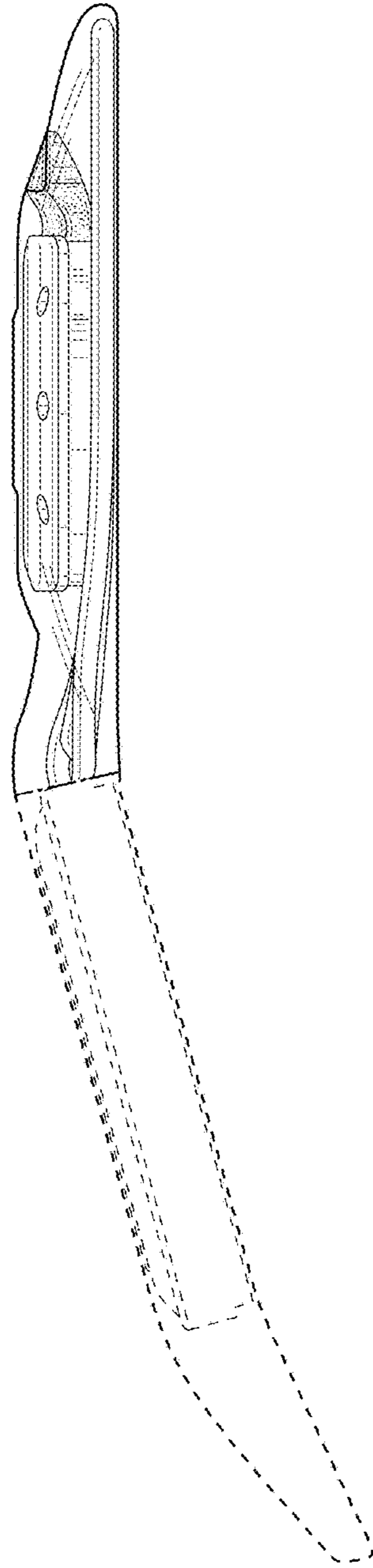
**FIG. 2**



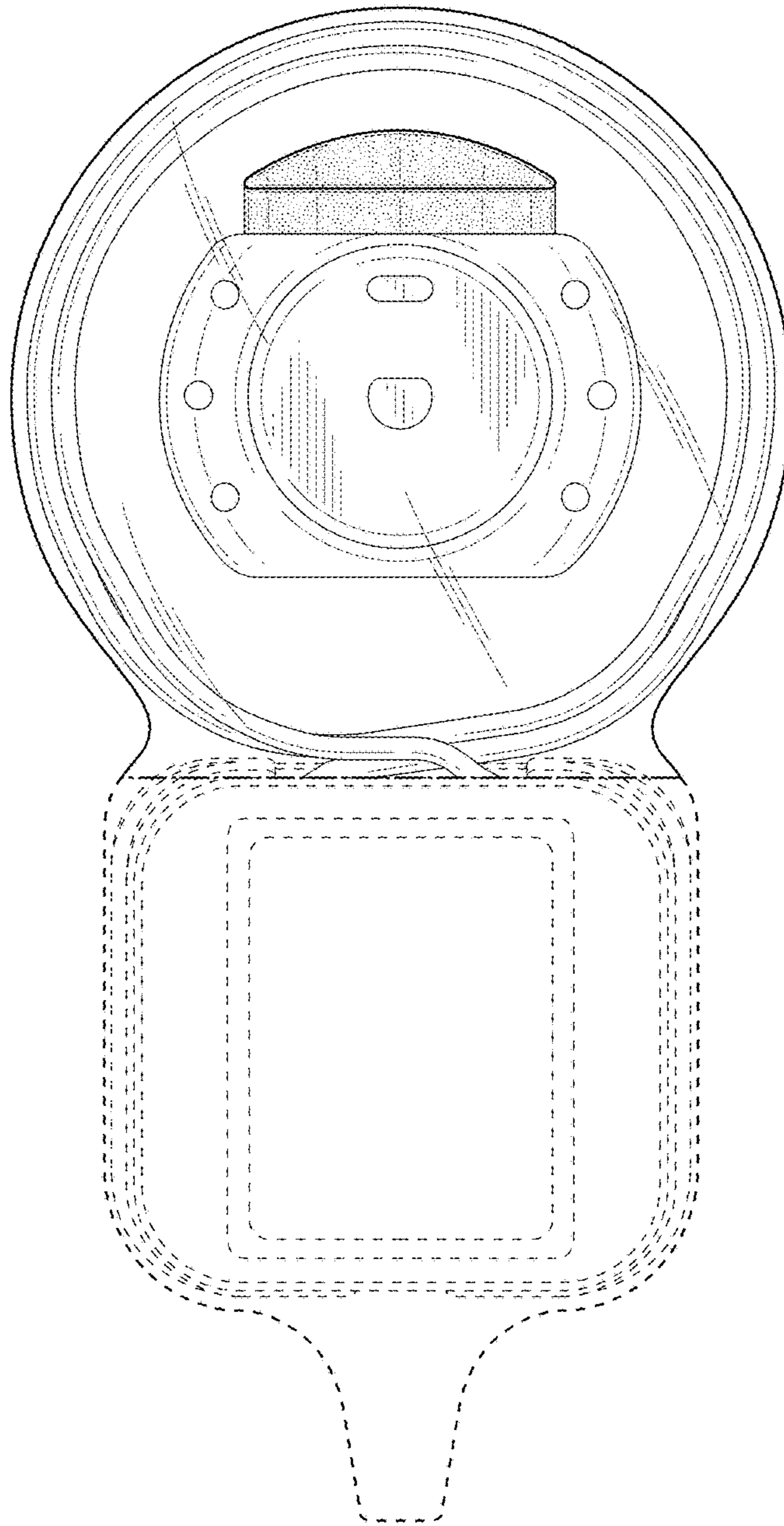
**FIG. 3**



**FIG. 4**

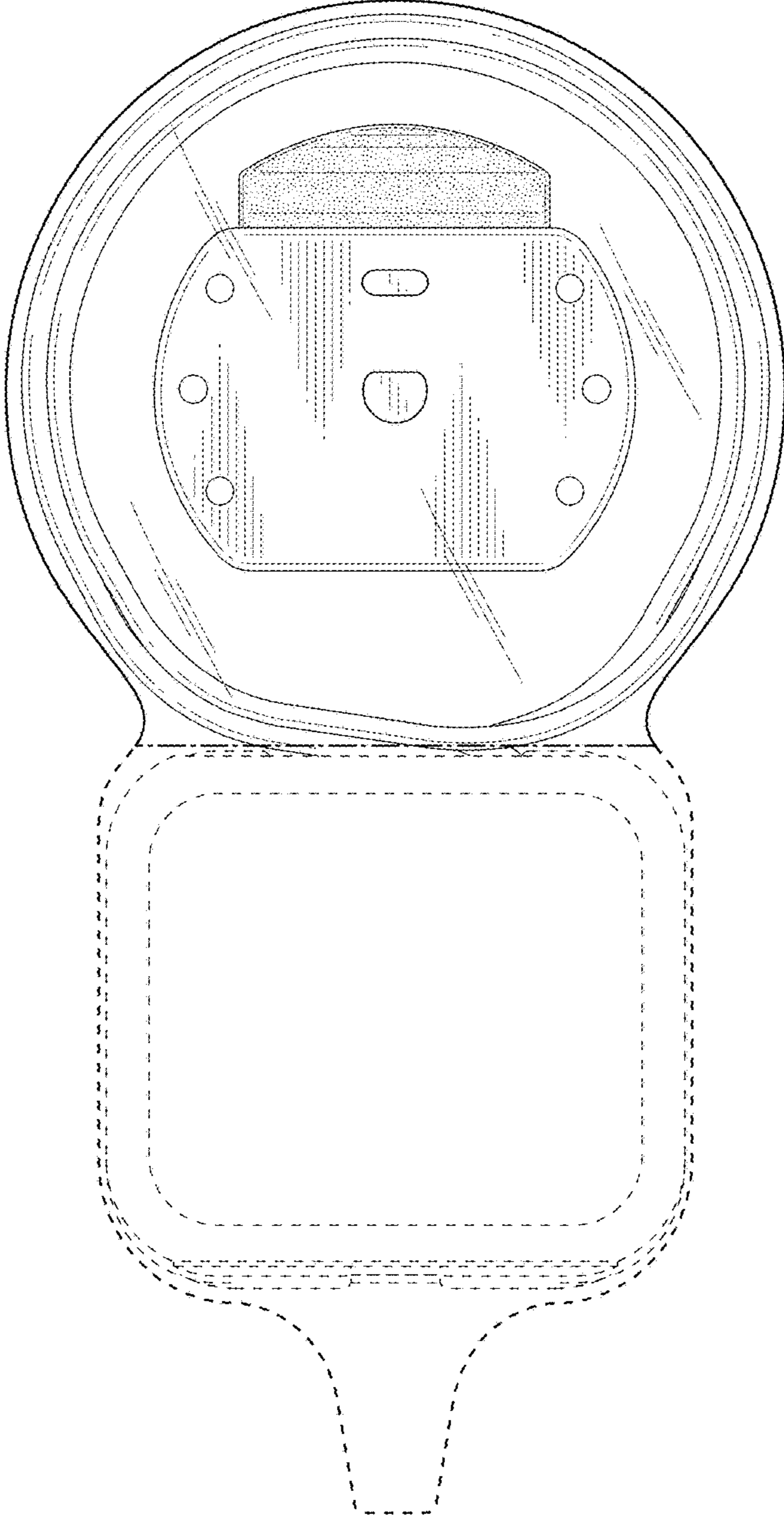


**FIG. 5**

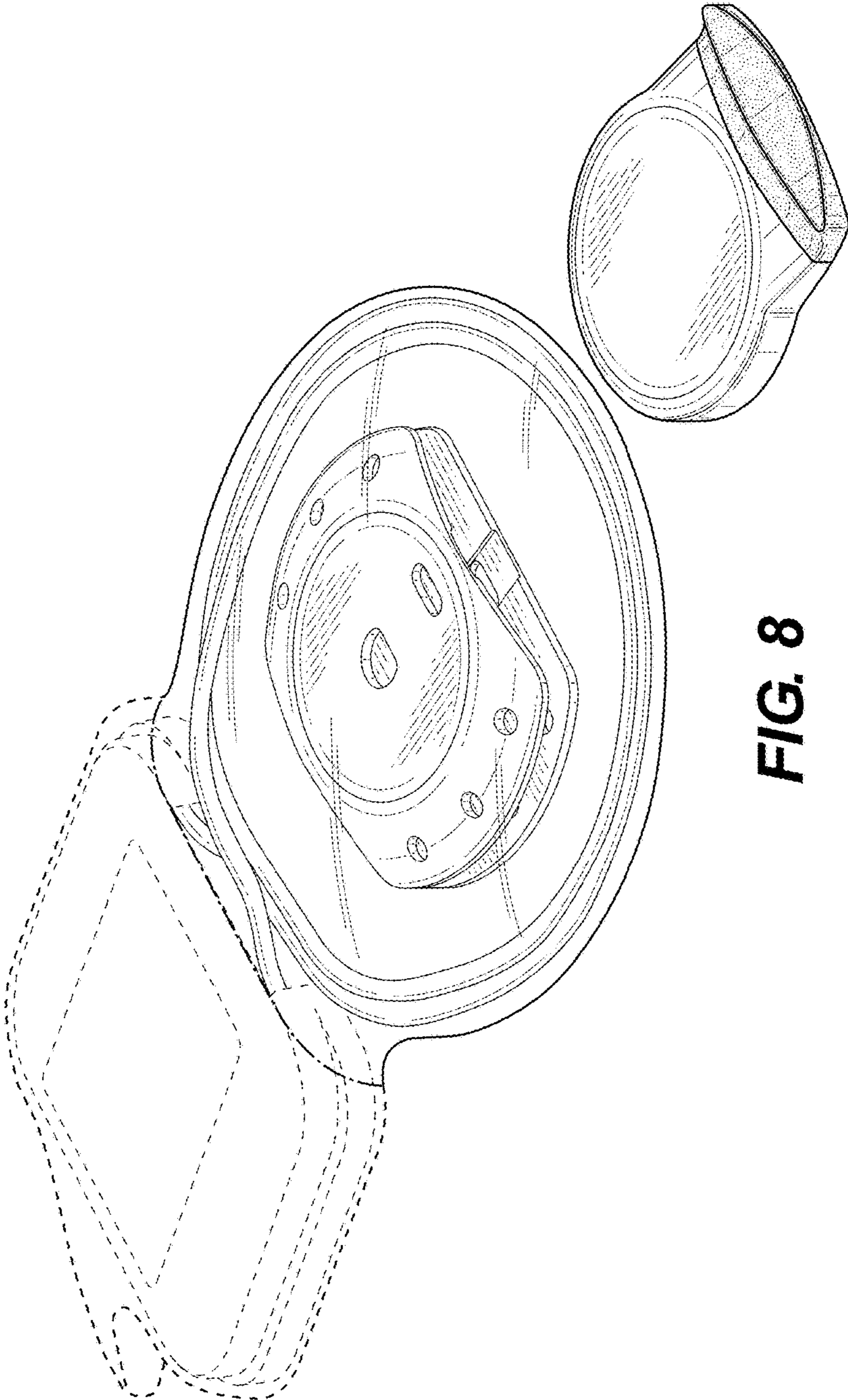


**FIG. 6**

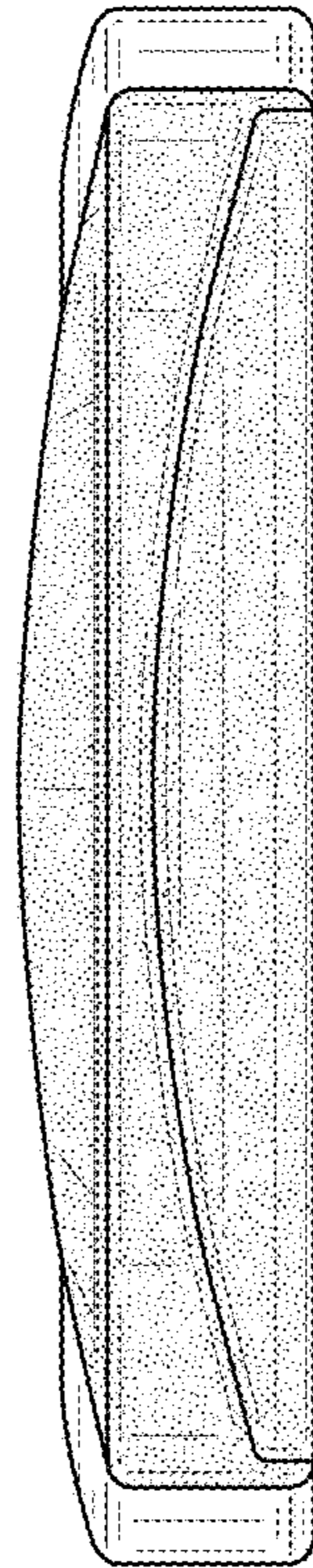




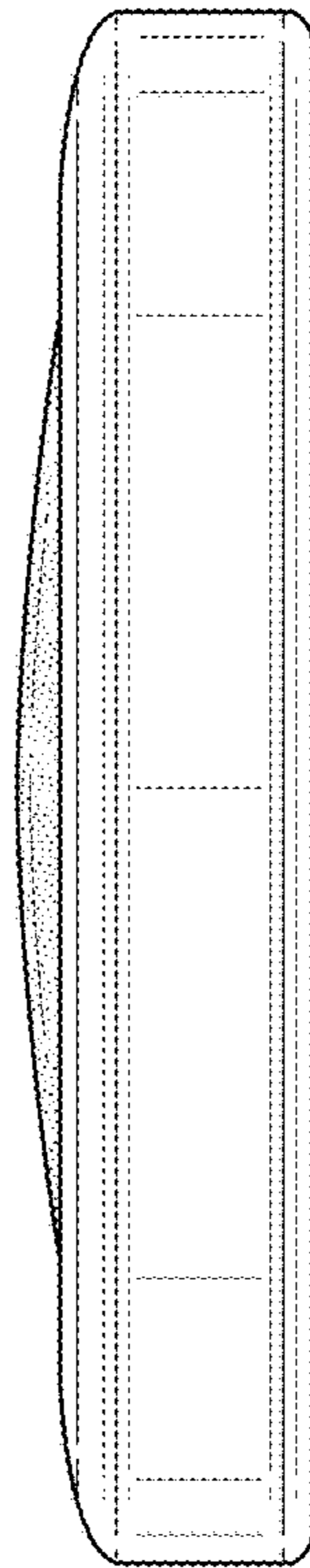
**FIG. 7**



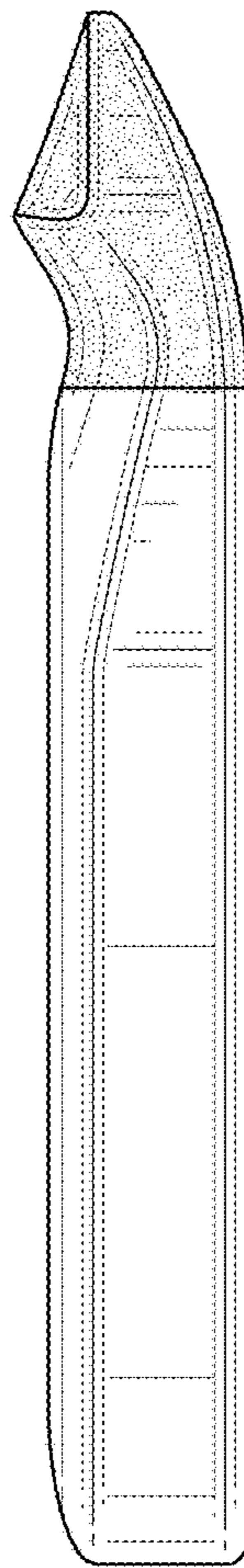
**FIG. 8**



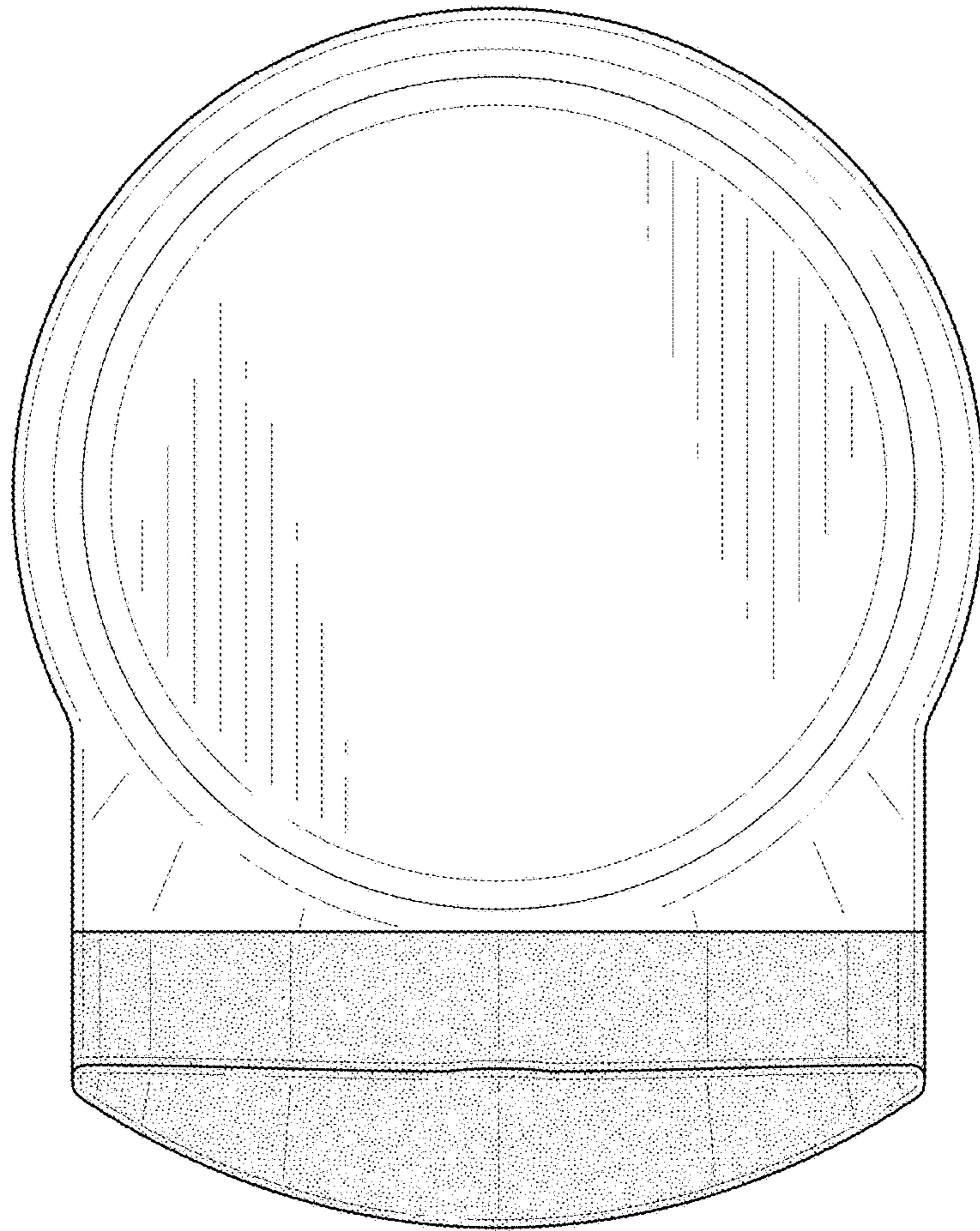
**FIG. 9**



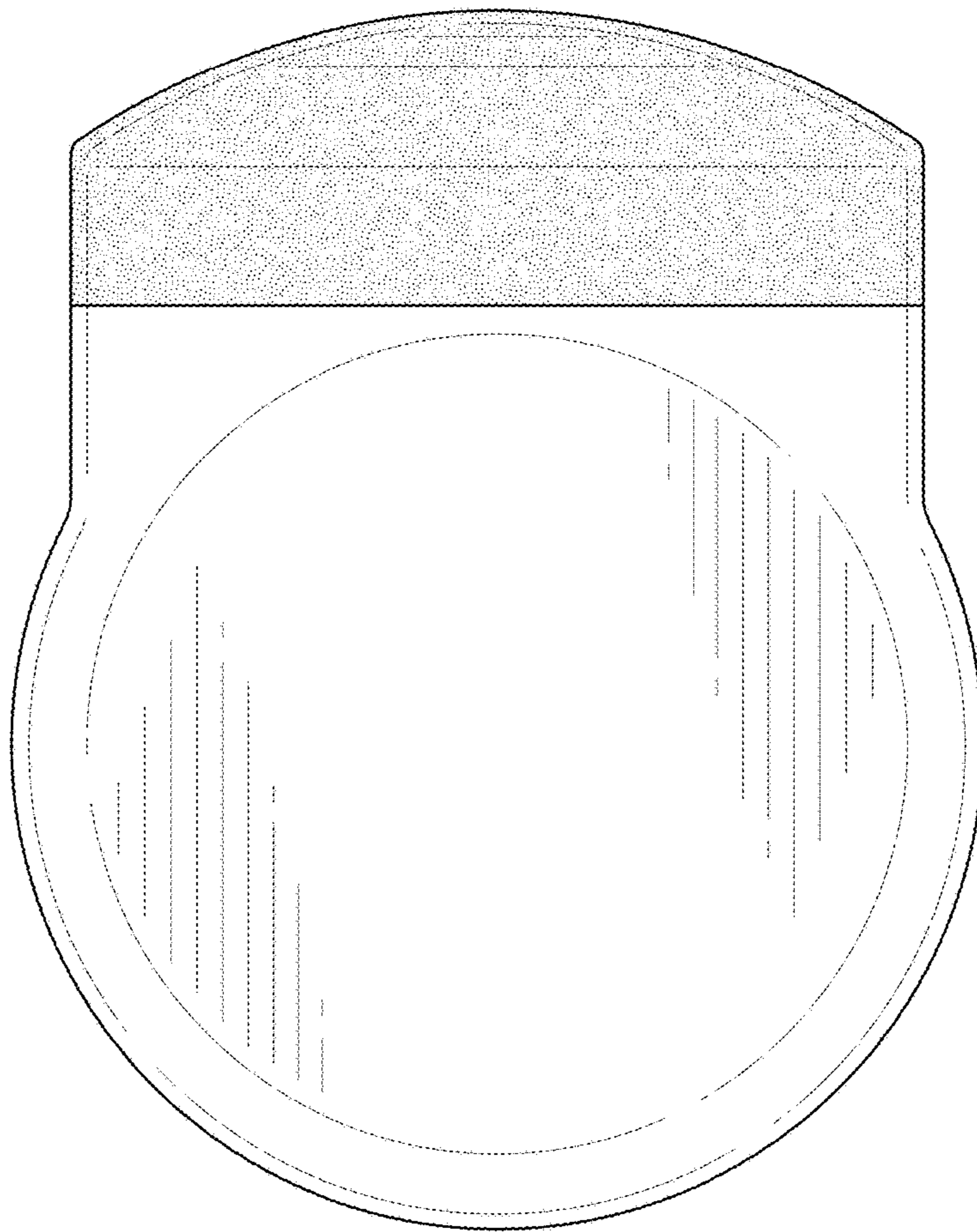
**FIG. 10**



**FIG. 11**



**FIG. 12**



**FIG. 13**