



US00D849731S

(12) **United States Design Patent** (10) **Patent No.:** **US D849,731 S**
Koo (45) **Date of Patent:** **** *May 28, 2019**

- (54) **CASE FOR ELECTRONIC COMMUNICATIONS DEVICE**
- (71) Applicant: **SPIGEN KOREA CO., LTD.**, Seoul (KR)
- (72) Inventor: **Eun Hee Koo**, Seoul (KR)
- (73) Assignee: **SPIGEN KOREA CO., LTD.**, Seoul (KR)
- (*) Notice: This patent is subject to a terminal disclaimer.
- (**) Term: **15 Years**
- (21) Appl. No.: **29/574,815**
- (22) Filed: **Aug. 18, 2016**
- (51) **LOC (11) Cl.** **14-03**
- (52) **U.S. Cl.**
USPC **D14/250**
- (58) **Field of Classification Search**
USPC D14/248, 439, 203.3–203.7, 217, 240, D14/447, 251–253, 238.1, 440, 250; D3/201, 218, 247, 269, 273, 301, 303; D13/103, 107–108, 119
CPC H04B 1/3888; H04M 1/0283; H04M 1/0202; A45C 1/06; A45C 2011/002; A45C 11/00; A45C 13/02; A45F 2005/026; A45F 2200/0525; A45F 2200/0516
See application file for complete search history.

- D669,458 S * 10/2012 Wilson D14/250
 - D675,604 S * 2/2013 Limber D14/250
 - D675,605 S * 2/2013 Adelman D14/250
 - D687,027 S * 7/2013 Melanson D14/250
- (Continued)

OTHER PUBLICATIONS

“iPhone 6 Plus Case Tough Armor”, <http://www.spigen.com/products/iphone-6-plus-case-tough-armor?variant=1156491337> Downloaded Oct. 20, 2016, 8 pages.

(Continued)

Primary Examiner — Carla J Wright

(74) *Attorney, Agent, or Firm* — Heedong Chae; Lucem, PC

(57) **CLAIM**

The ornamental design for a case for electronic communications device, as shown and described.

DESCRIPTION

FIG. 1 is a front perspective view of a case for an electronic communications device showing my new design;
 FIG. 2 is a rear perspective view thereof;
 FIG. 3 is a front elevational view thereof;
 FIG. 4 is a rear elevational view thereof;
 FIG. 5 is a left side elevational view thereof;
 FIG. 6 is a right side elevational view thereof;
 FIG. 7 is a top plan view thereof;
 FIG. 8 is a bottom plan view thereof;
 FIG. 9 is a front perspective view thereof showing the lower portion in an open position; and,
 FIG. 10 is a rear perspective view of thereof showing the lower portion in the open position.

The broken lines throughout the drawing disclosure depict portions of the case that form no part of the claimed design. The broken lines and regions bounded by broken lines form no part of the claimed design.

1 Claim, 10 Drawing Sheets

(56) **References Cited**

U.S. PATENT DOCUMENTS

- D575,056 S * 8/2008 Tan D3/201
- D618,230 S * 6/2010 Brown D14/250
- D623,180 S * 9/2010 Diebel D14/250
- D624,909 S * 10/2010 Huskinson D14/250
- D652,031 S * 1/2012 Fahrendorff D14/250
- D654,068 S * 2/2012 Monaco D14/250

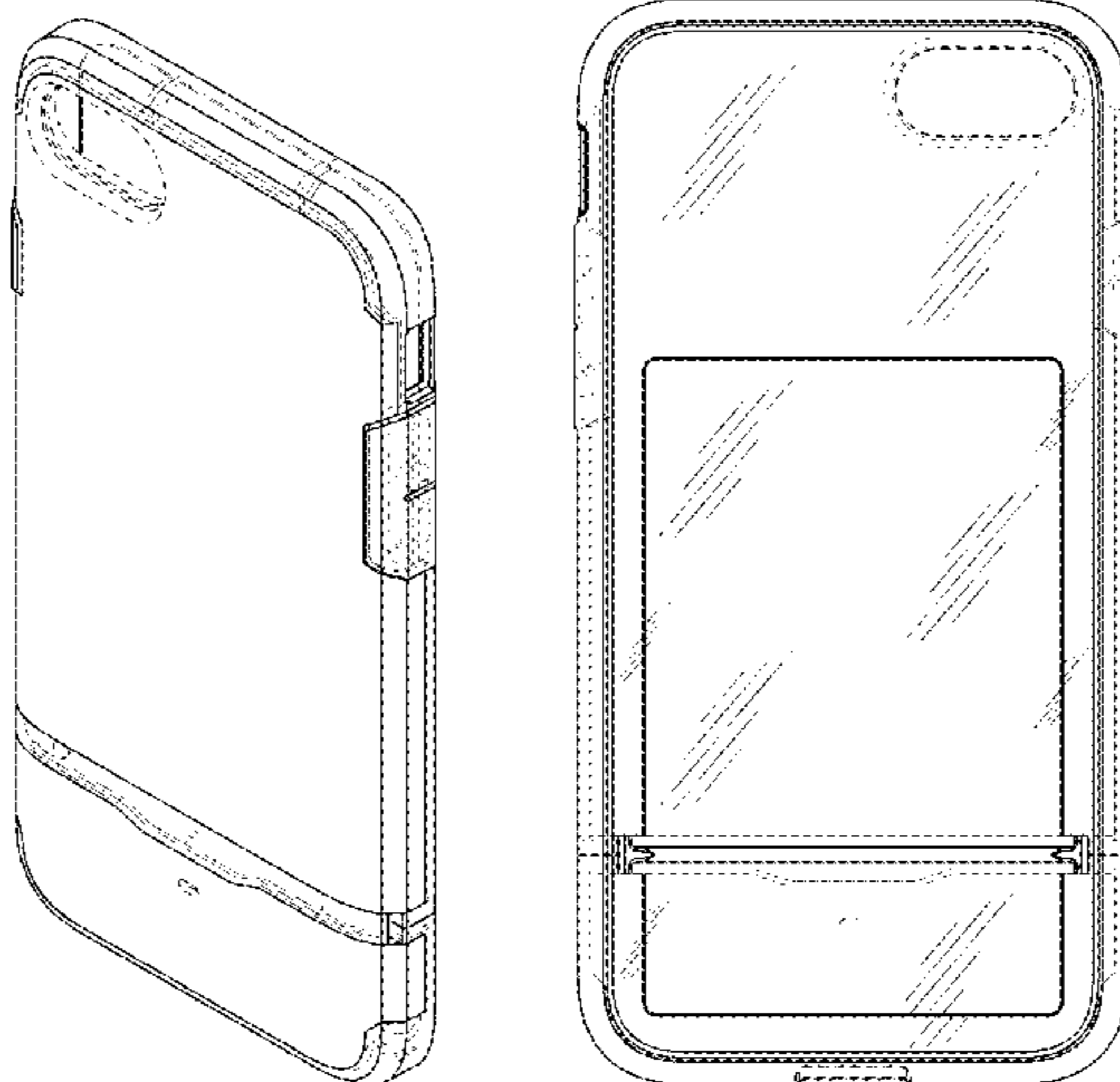

(56)

References Cited

OTHER PUBLICATIONS

U.S. PATENT DOCUMENTS

D694,743 S * 12/2013 Monaco D14/250
 D698,774 S * 2/2014 Wardy D14/250
 D703,646 S * 4/2014 Fathollahi D14/250
 D714,278 S * 9/2014 Case D14/250
 D717,773 S * 11/2014 Fathollahi D14/250
 D717,776 S * 11/2014 Hemesath D14/250
 D718,293 S * 11/2014 Namminga D14/250
 D718,754 S * 12/2014 To D14/250
 D720,733 S * 1/2015 Fathollahi D14/250
 D720,734 S * 1/2015 Fathollahi D14/250
 D720,739 S * 1/2015 Liu D14/250
 D721,356 S * 1/2015 Hasbrook D14/250
 D725,643 S * 3/2015 Lee D14/250
 D741,845 S 10/2015 Kim
 D743,389 S 11/2015 Akana et al.
 9,185,813 B2 11/2015 Diebel
 D744,472 S 12/2015 Lerenthal
 D744,993 S 12/2015 Diebel
 D744,995 S 12/2015 Lerenthal
 D745,507 S 12/2015 Adami
 D746,273 S 12/2015 Herbst
 D746,275 S 12/2015 Mohammad
 D746,805 S 1/2016 Kim
 D747,706 S 1/2016 Tien
 D749,555 S 2/2016 Poon
 D753,099 S 4/2016 Kim
 D753,641 S 4/2016 Roberts et al.
 D754,651 S 4/2016 Roberts et al.
 D754,652 S 4/2016 Roberts et al.
 9,313,305 B1 4/2016 Diebel
 9,319,501 B2 4/2016 Huang
 D756,340 S 5/2016 Babichenko
 D756,344 S 5/2016 Roberts et al.
 D756,909 S 5/2016 Gupta
 D756,910 S 5/2016 Gupta
 D756,911 S 5/2016 Gupta
 D757,702 S 5/2016 Kanazawa
 D759,642 S 6/2016 Chao
 D761,239 S 7/2016 Kim
 D761,774 S 7/2016 Liang
 D763,842 S 8/2016 Chang et al.
 D765,643 S * 9/2016 Witter D14/250
 D767,485 S 9/2016 To et al.
 2009/0186264 A1 * 7/2009 Huang H01M 2/1022
 429/96

“iPhone 5,5s Case Tough Armor”, <http://www.spigen.com/products/iphone-5s-5-case-tough-armor?variant=116553125> Downloaded Oct. 20, 2016, 5 pages.
 “Tough Armor !Iphone SE Case”, <http://www.spigen.com/products/iphone-se-case-tough-armor?variant=16524825729> Downloaded Oct. 20, 2016, 7 pages.
 “iPhone 6 Case Tough Armor FX”, <http://www.spigen.com/products/iphone-6-case-tough-armor-fx-4-7?variant=1151179433> Downloaded Oct. 20, 2016, 8 pages.
 “iPhone 6 Case Tough Armor S”, <http://www.spigen.com/products/iphone-6-case-tough-armor-s-4-7?variant=1154344701> Downloaded Oct. 20, 2016, 8 pages.
 “iPhone 6S Plus Case Tough Armor,” <http://www.spigen.com/products/iphone-6s-plus-case-tough-armor?variant=4039960961> Downloaded Oct. 20, 2016, 8 pages.
 “iPhone 6S Case Tough Armor”, <http://www.spigen.com/products/iphone-6s-case-tough-armor?variant=5904808705> Downloaded Oct. 20, 2016, 7 pages.
 “iPhone 6S Plus Case Tough Armor Tech”, <http://www.spigen.com/products/iphone-6s-plus-case-tough-armor-tech?variant=5811399809> Downloaded Oct. 20, 2016, 8 pages.
 “iPhone 6S Case Tough Armor Tech”, <http://www.spigen.com/products/iphone-6s-case-tough-armor-tech?variant=5811305217> Downloaded Oct. 20, 2016, 7 pages.
 “iPhone 6S/6 Case Tough Armor Volt” <http://www.spigen.com/products/iphone-6-case-tough-armor-volt-4-7> Downloaded Oct. 20, 2016, 6 pages.
 “iPhone 6s Case, Kroma [Chameleon Series] Heavy Duty Wallet Case for iPhone 6s (Black),” <https://www.amazon.com/iPhone-Kroma-Chameleon-Heavy-Wallet/dp81A0C8QHG>. Downloaded Aug. 9, 2016, 9 page.
 “iPhone 6 Case Tough Armor,”<http://www.spigen.com/products/iphone6casetougharmor47?variant=1154323053>, Downloaded Aug. 9, 2016, 6 page.
 “Speck CandyShell Flip Iphone 4 Case Lets You Dock Phone With Protection,” <http://www.itechnews.net/2010/11/23/speckcandyshe/fliphone4caseletsyoudockiphonewithprotection/>, Downloaded Aug. 9, 2016, 4 page.

* cited by examiner

FIG. 1

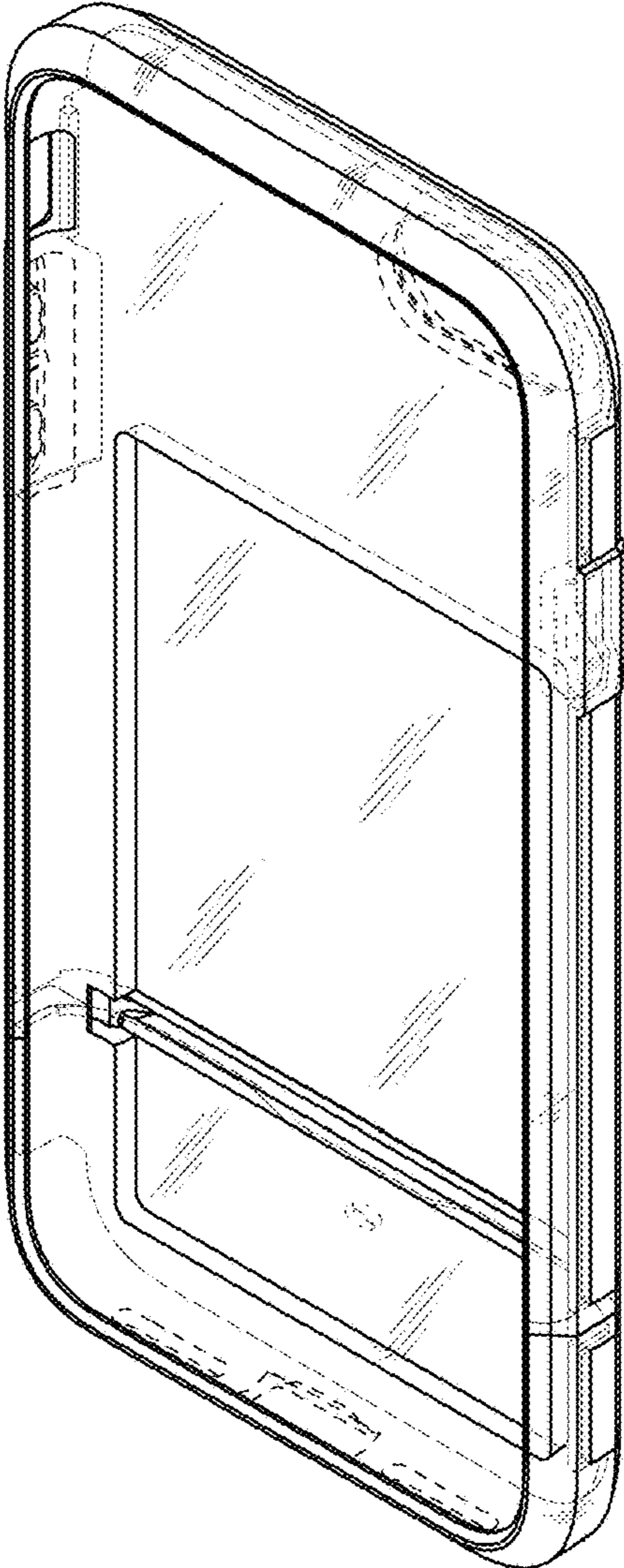

FIG. 2

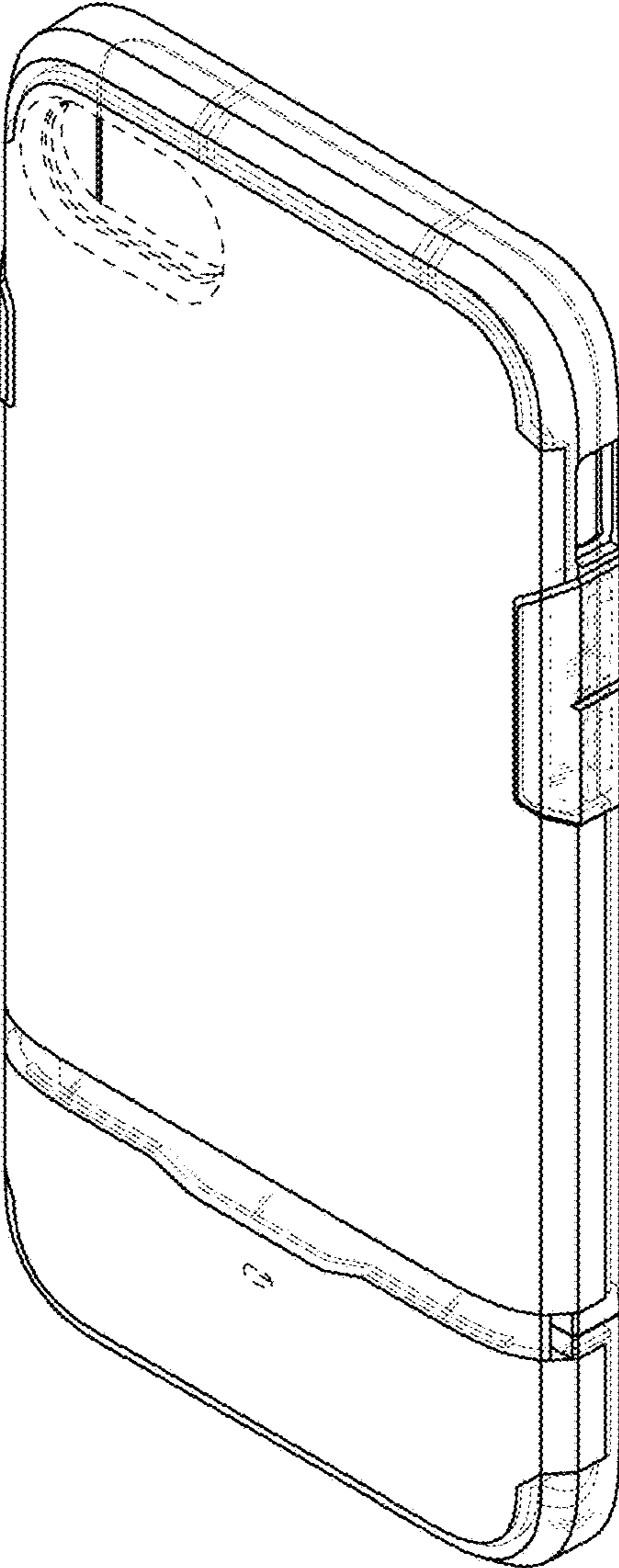

FIG. 3

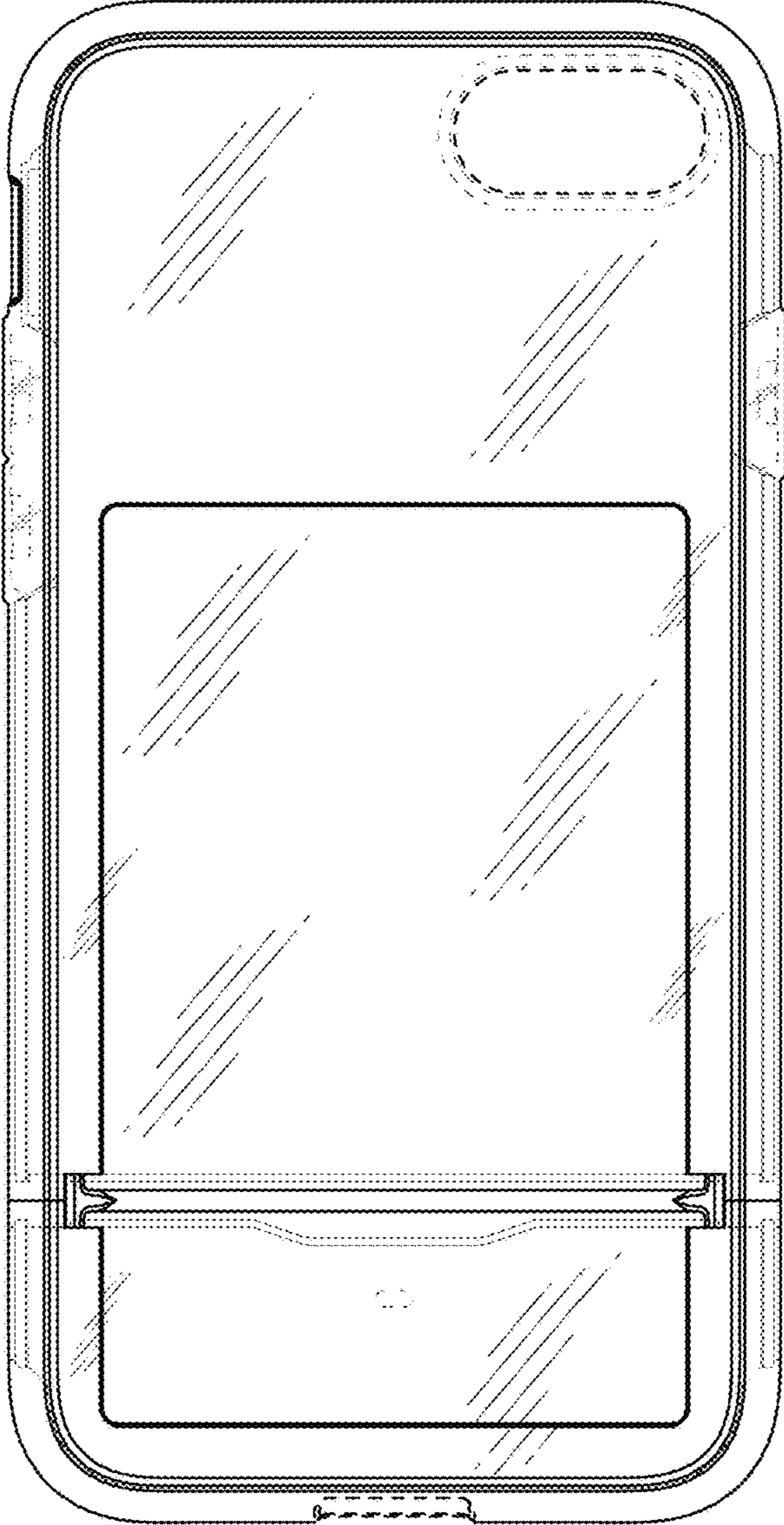

FIG. 4

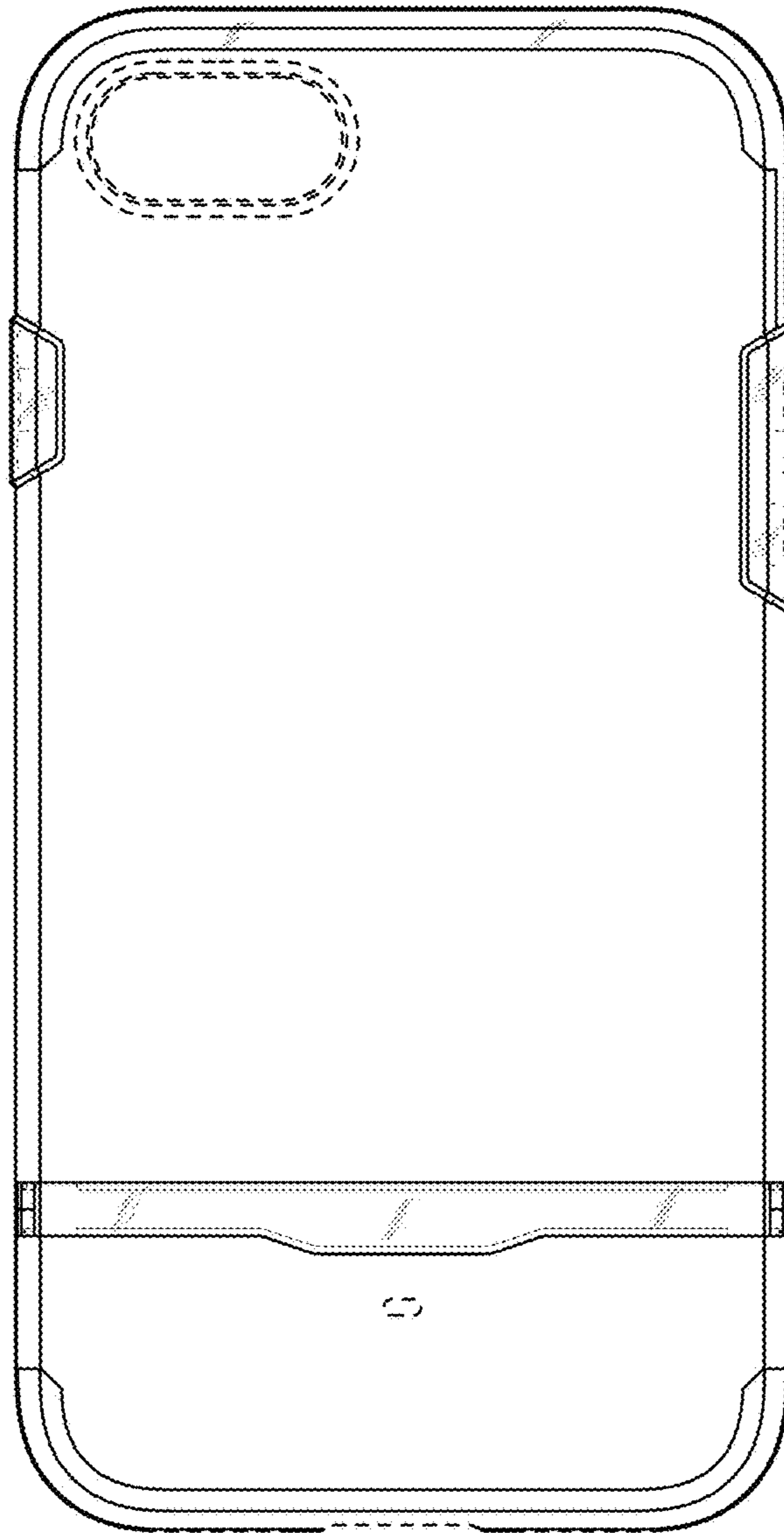

FIG. 5

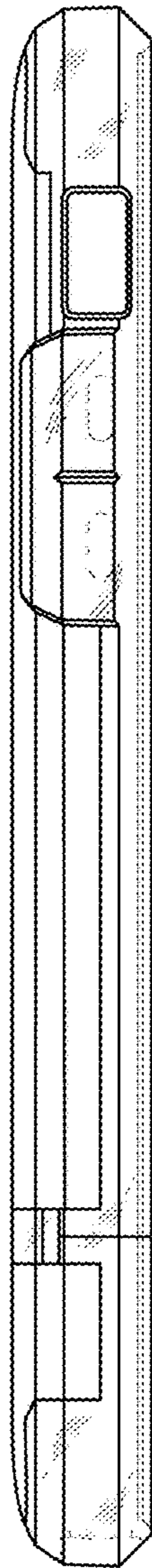

FIG. 6

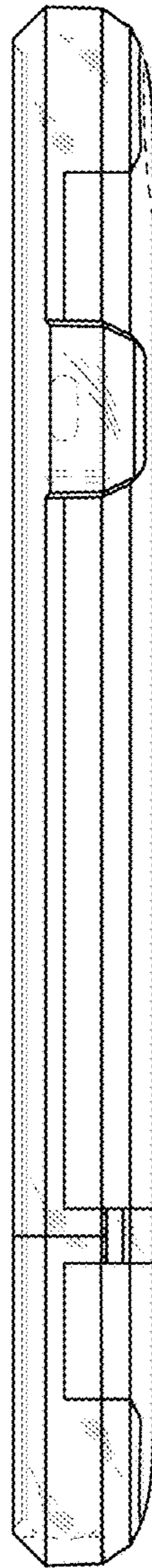

FIG. 7

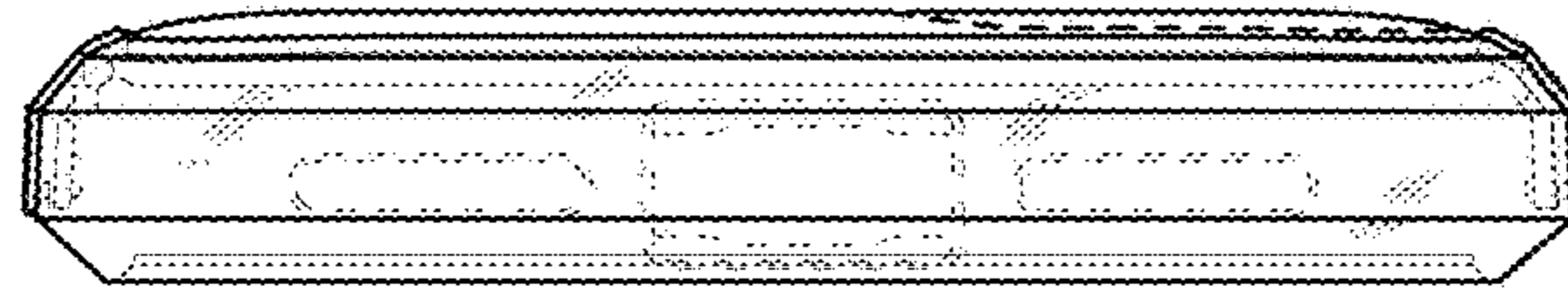

FIG. 8

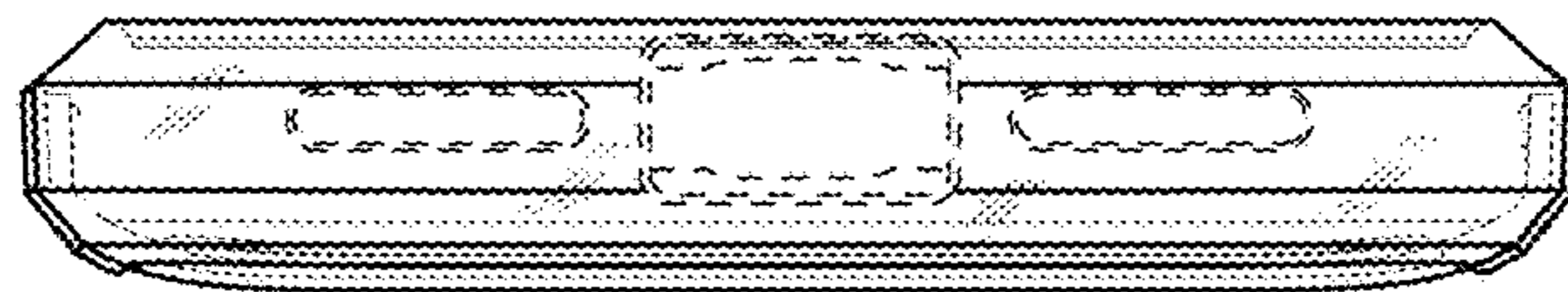

FIG. 9

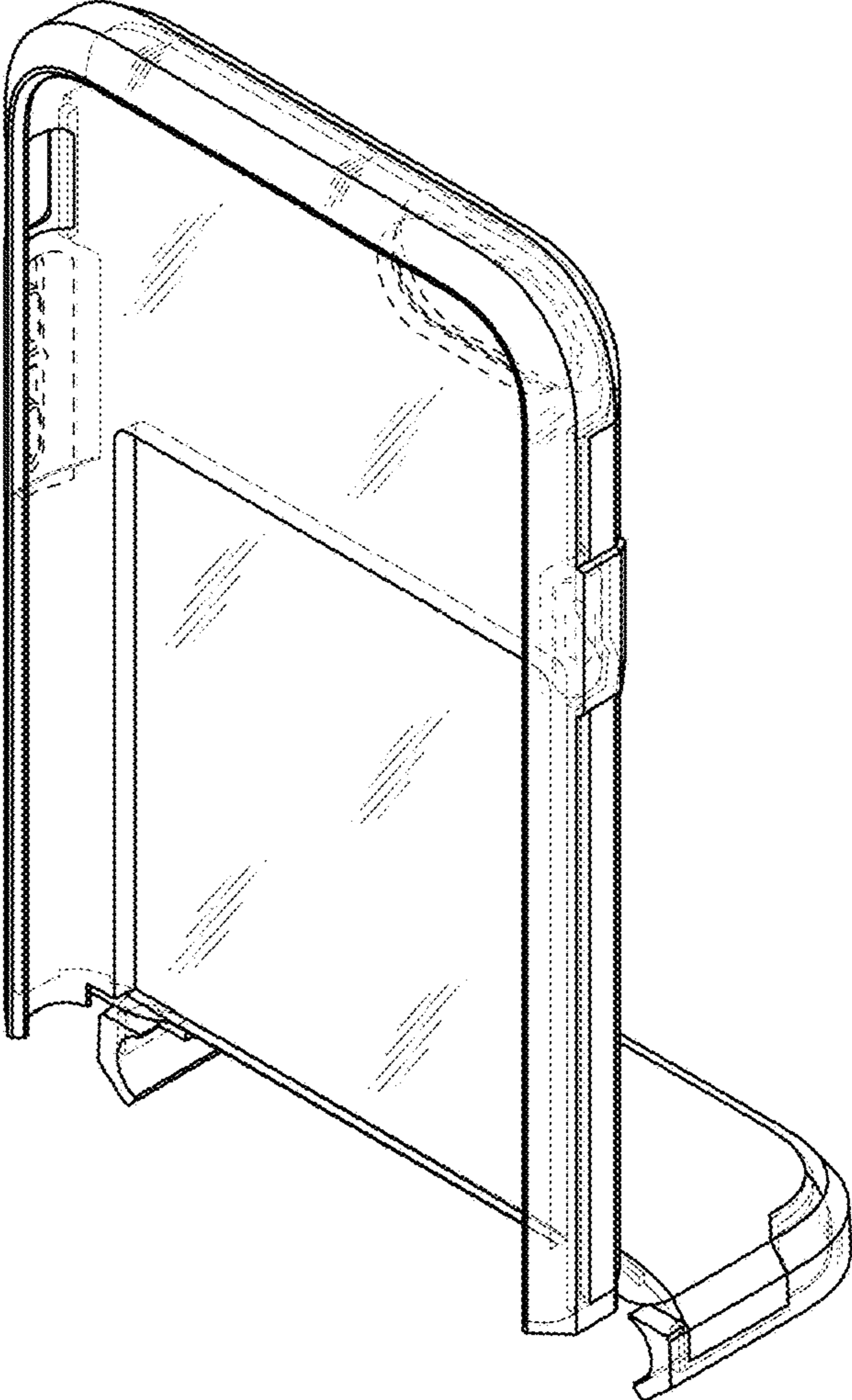

FIG. 10

