



US00D849711S

(12) **United States Design Patent**
Bentley

(10) **Patent No.:** **US D849,711 S**

(45) **Date of Patent:** **** May 28, 2019**

- (54) **SPEAKERBRA**
- (71) Applicant: **SPEAKERBRA INC.**, Toronto (CA)
- (72) Inventor: **Victoria Bentley**, Toronto (CA)
- (73) Assignee: **SPEAKERBRA INC.**, Toronto, ON (CA)
- (**) Term: **15 Years**
- (21) Appl. No.: **29/609,339**
- (22) Filed: **Jun. 29, 2017**
- (51) **LOC (11) Cl.** **14-01**
- (52) **U.S. Cl.**
USPC **D14/192; D14/207**
- (58) **Field of Classification Search**
USPC D14/204, 224.1, 203.5, 192, 496, 207, D14/221; D2/700, 703, 704, 706, 707, D2/708, 711, 716, 717; 2/71, 7, 92, 102, 2/103, 110, 119, 120; 450/70, 80, 89, 93, 450/39, 59; 181/129, 130, 135; 379/430, 379/431; 381/380, 381; 455/90.3, 569.1, 455/575.1; D3/218
CPC H04R 1/02; H04R 5/00; H04R 5/02; A41C 3/12; A41C 3/00; A45C 11/00
See application file for complete search history.

(56) **References Cited**

U.S. PATENT DOCUMENTS

- 2,676,738 A * 4/1954 Herrick A45F 3/14
224/249
- 4,070,553 A * 1/1978 Hass H04M 1/05
381/151
- 4,500,019 A * 2/1985 Curley, Jr. A45F 5/00
224/222
- 4,539,700 A * 9/1985 Sato H04R 5/023
224/230
- 4,583,544 A * 4/1986 Flanagan A41C 3/0057
2/67

- 4,589,134 A * 5/1986 Waldron H04R 5/02
381/301
- D300,382 S * 3/1989 Keithan D2/708
- 4,825,471 A * 5/1989 Jennings A41D 1/002
2/115
- 5,621,914 A * 4/1997 Ramone A41D 13/015
2/115
- 5,708,978 A * 1/1998 Johnsrud A41D 13/1245
2/102

(Continued)

Primary Examiner — Paula Allen Greene

(74) *Attorney, Agent, or Firm* — Hill & Schumacher

(57) **CLAIM**

The ornamental design for a speakerbra, as shown and described.

DESCRIPTION

FIG. 1 is a perspective view of one embodiment of a speakerbra showing my design;
 FIG. 2 is a top plan view thereof;
 FIG. 3 is a front elevation view thereof;
 FIG. 4 is a rear elevation view thereof;
 FIG. 5 is a bottom plan view thereof;
 FIG. 6 is a right side elevated view thereof;
 FIG. 7 is a left side elevated view thereof;
 FIG. 8 is a perspective view showing an alternate position of an element of the design thereof;
 FIG. 9 is a second perspective view thereof;
 FIG. 10 is a perspective view showing an alternate position of an element of the design thereof;
 FIG. 11 is a perspective view showing an alternate position of an element of the design thereof; and,
 FIG. 12 is a perspective view showing an alternate position of an element of the design thereof.
 The broken lines in the drawing views are included for the purpose of illustrating portions of the speakerbra that do not form part of the claimed design.
 The shading used in the drawings does not form part of the claimed design.

1 Claim, 9 Drawing Sheets

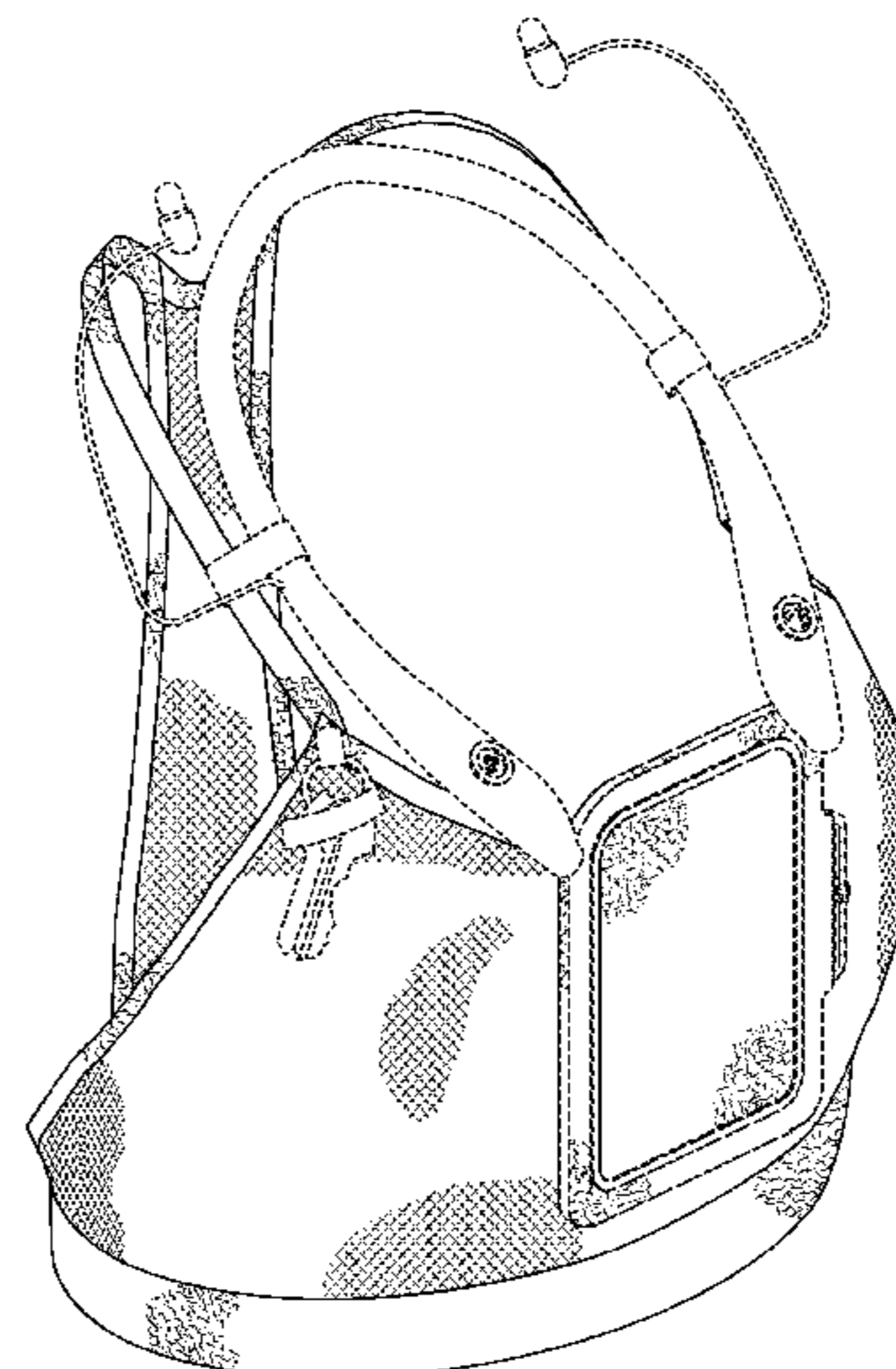
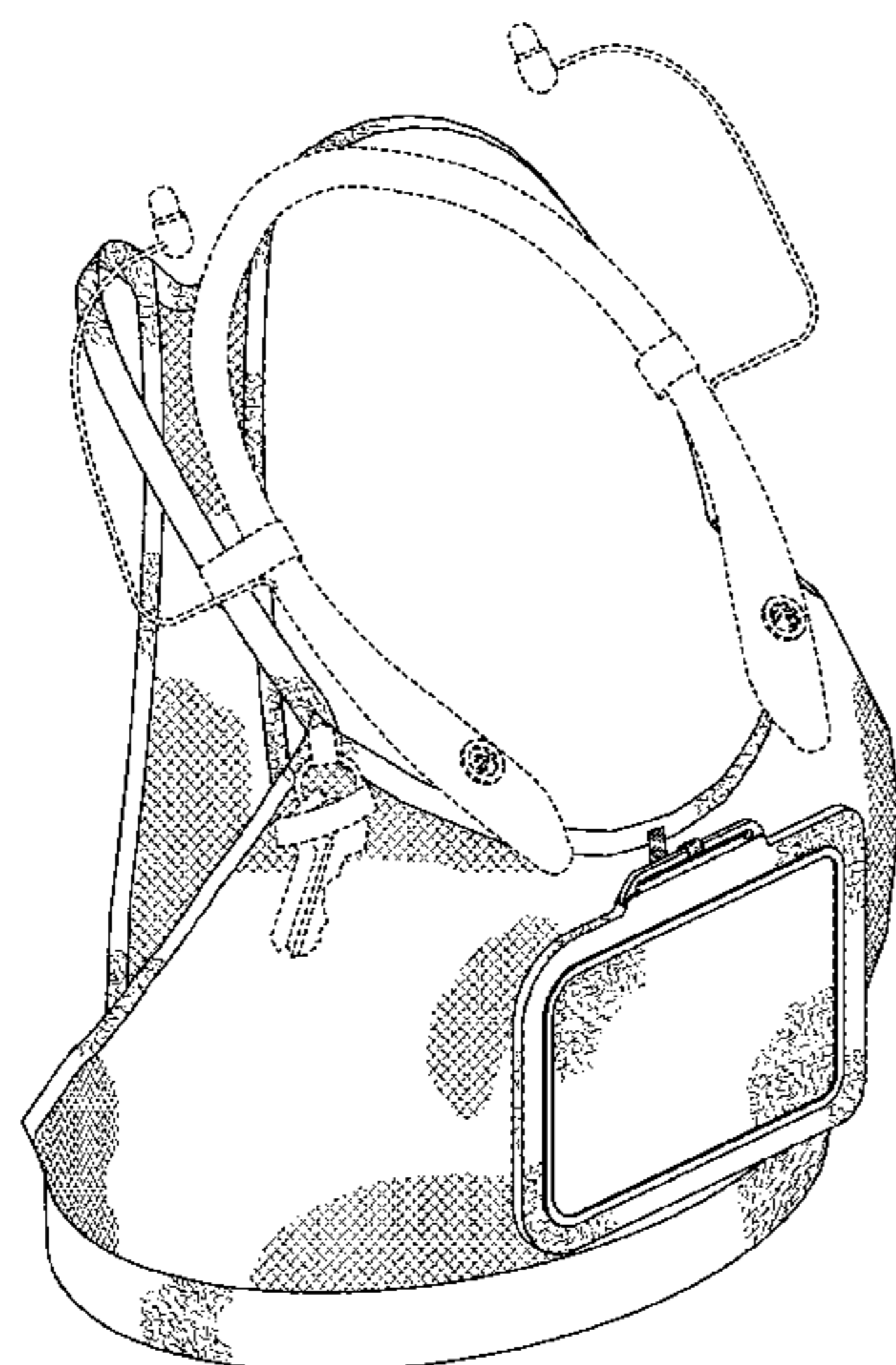

(56)

References Cited

U.S. PATENT DOCUMENTS

6,110,005 A * 8/2000 Stephenson A41C 3/10
450/39
D460,432 S * 7/2002 Brown D14/192
D529,896 S * 10/2006 Anderson D14/189
D616,417 S * 5/2010 Liao D14/203.5
D658,352 S * 5/2012 Pinner D2/706
D671,296 S * 11/2012 Iamartino D2/708
8,465,341 B2 * 6/2013 Shashy A41C 3/0057
450/39
D735,970 S * 8/2015 Congdon D2/708
D759,957 S * 6/2016 Willows D3/218
9,480,287 B2 * 11/2016 Black A41C 3/0057
D773,433 S * 12/2016 Spasojevic H04R 1/1016
D14/192
D774,751 S * 12/2016 Pomerantz D3/218
D798,535 S * 10/2017 McManus D2/708
D816,636 S * 5/2018 Birger D14/205
D822,380 S * 7/2018 McBrayer D3/218
D831,335 S * 10/2018 Crease D3/218
2008/0032600 A1 * 2/2008 Updyke A41C 3/0035
450/89
2010/0005569 A1 * 1/2010 Sanders A41C 1/003
2/400
2012/0122370 A1 * 5/2012 Heath A41C 3/0057
450/80
2013/0225042 A1 * 8/2013 Ave G09F 21/026
450/1
2014/0317823 A1 * 10/2014 Hanson A41D 15/005
2/69

* cited by examiner

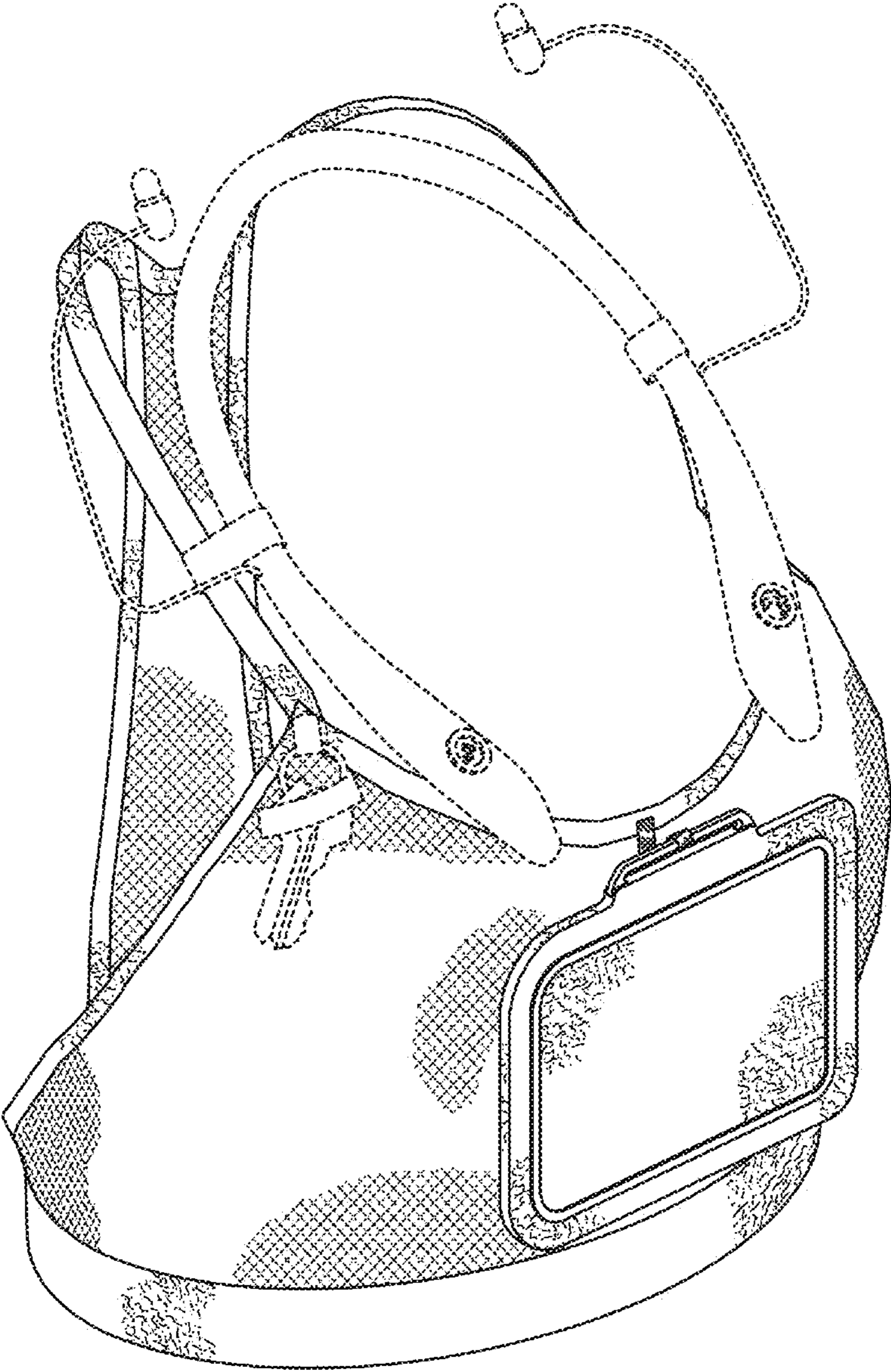

FIG. 1

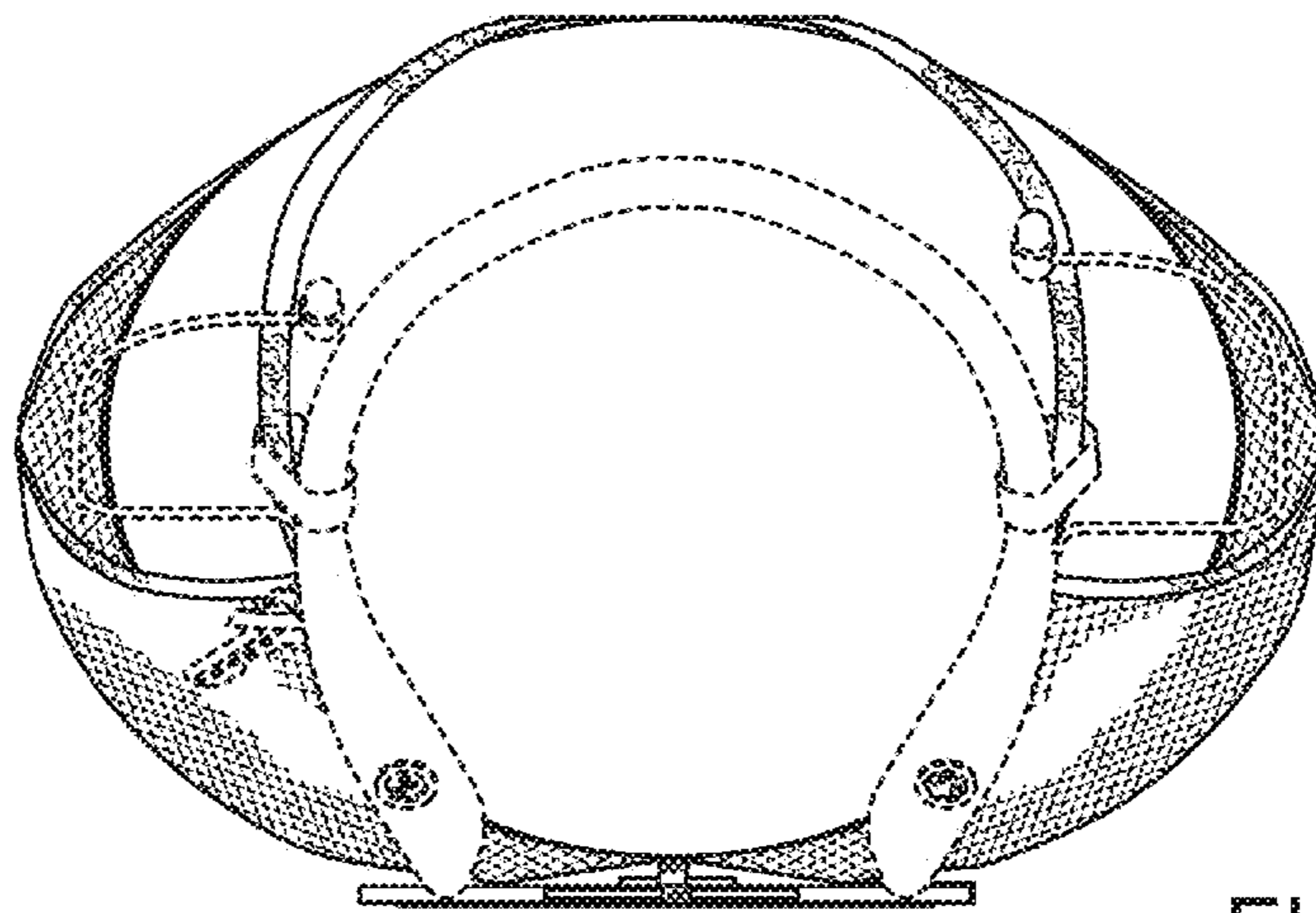

FIG. 2

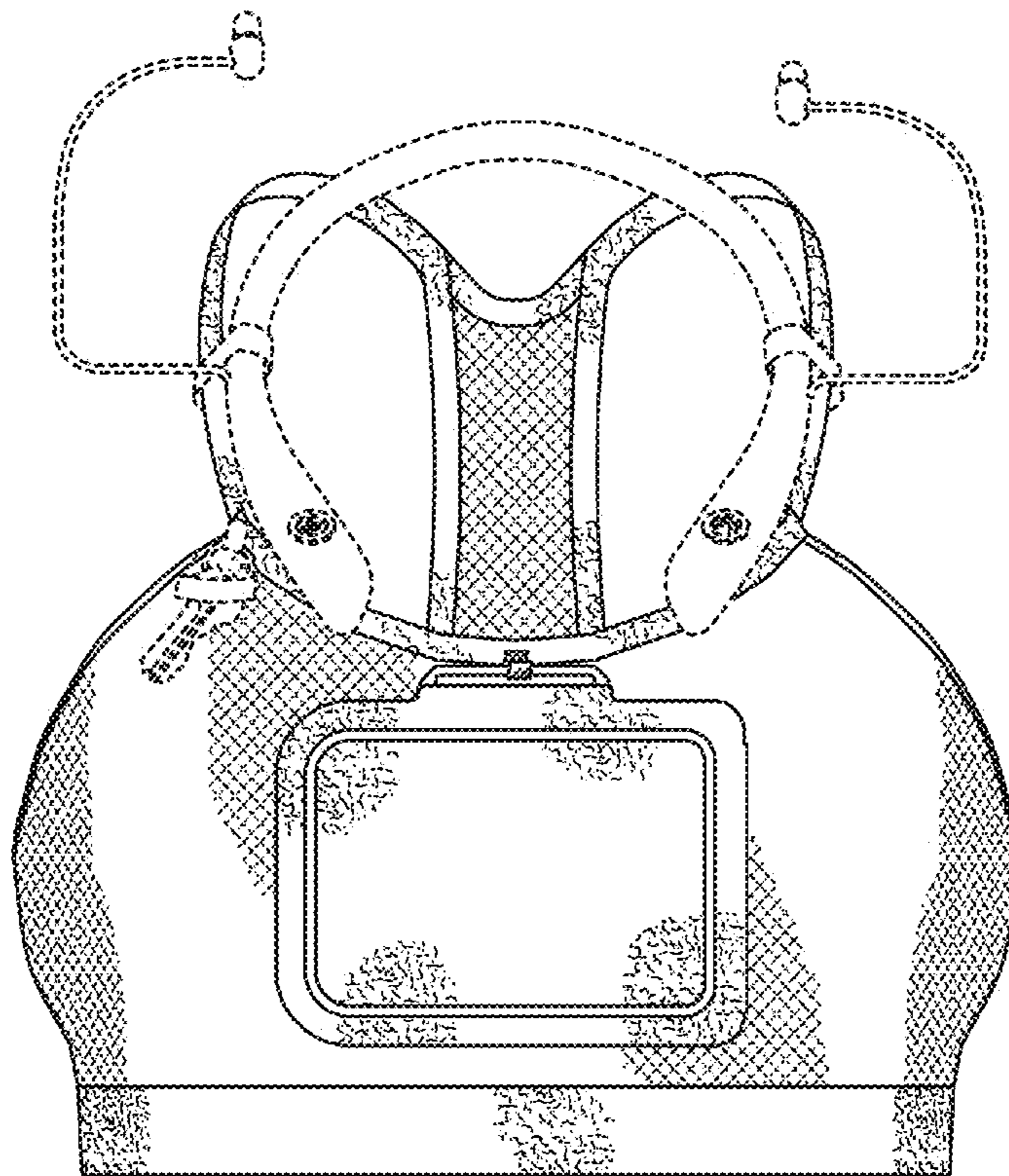

FIG. 3

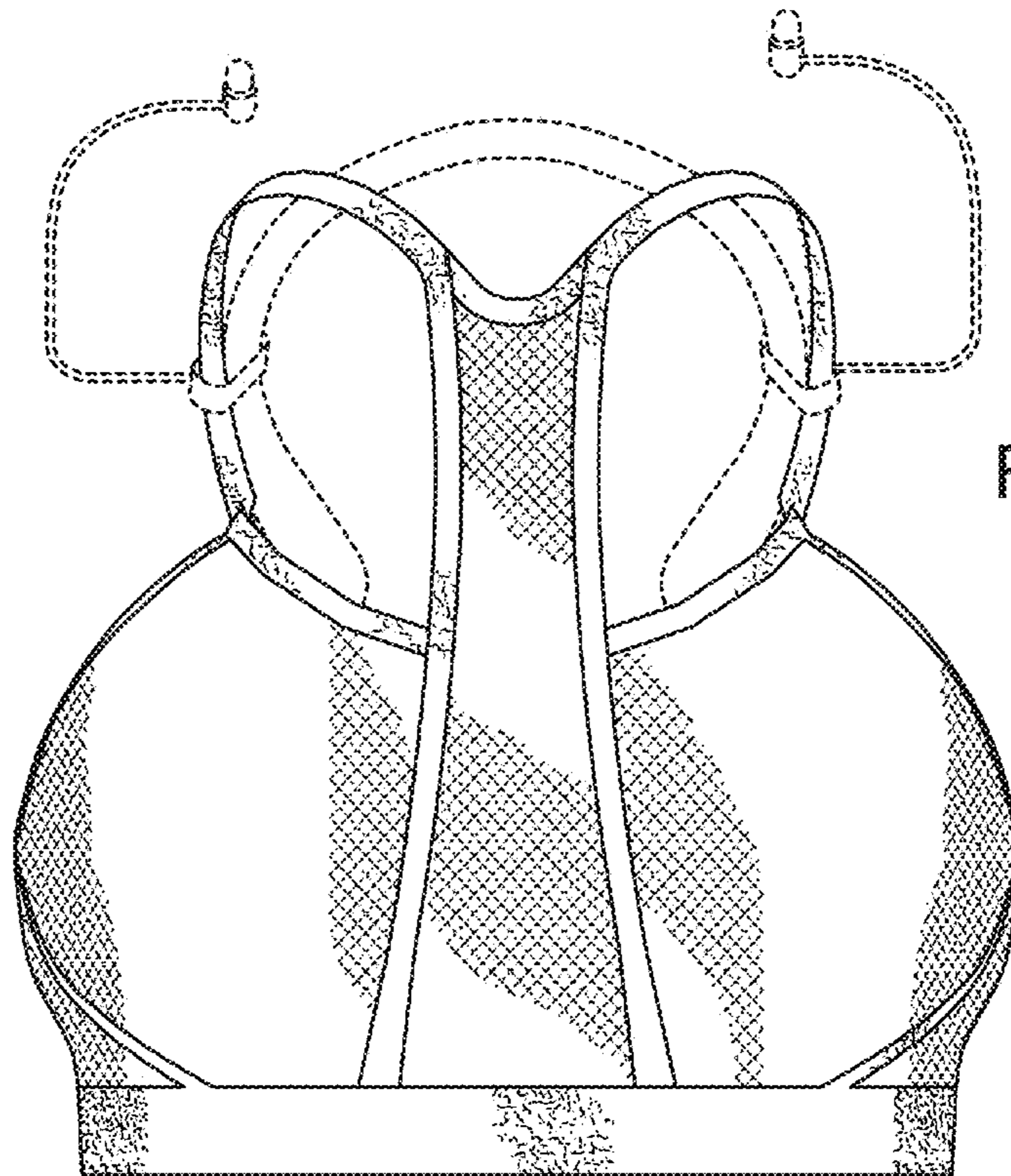

FIG. 4

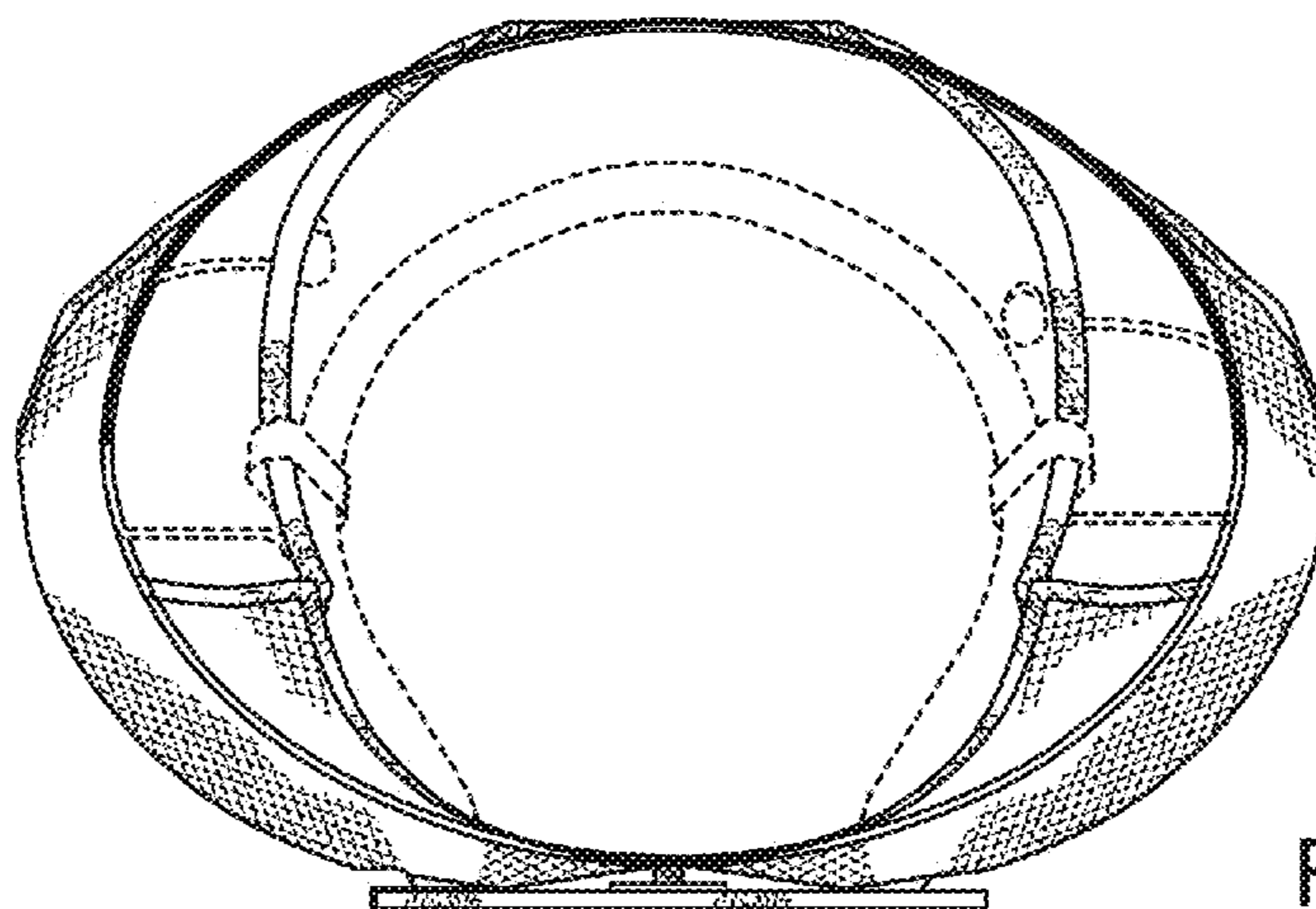

FIG. 5

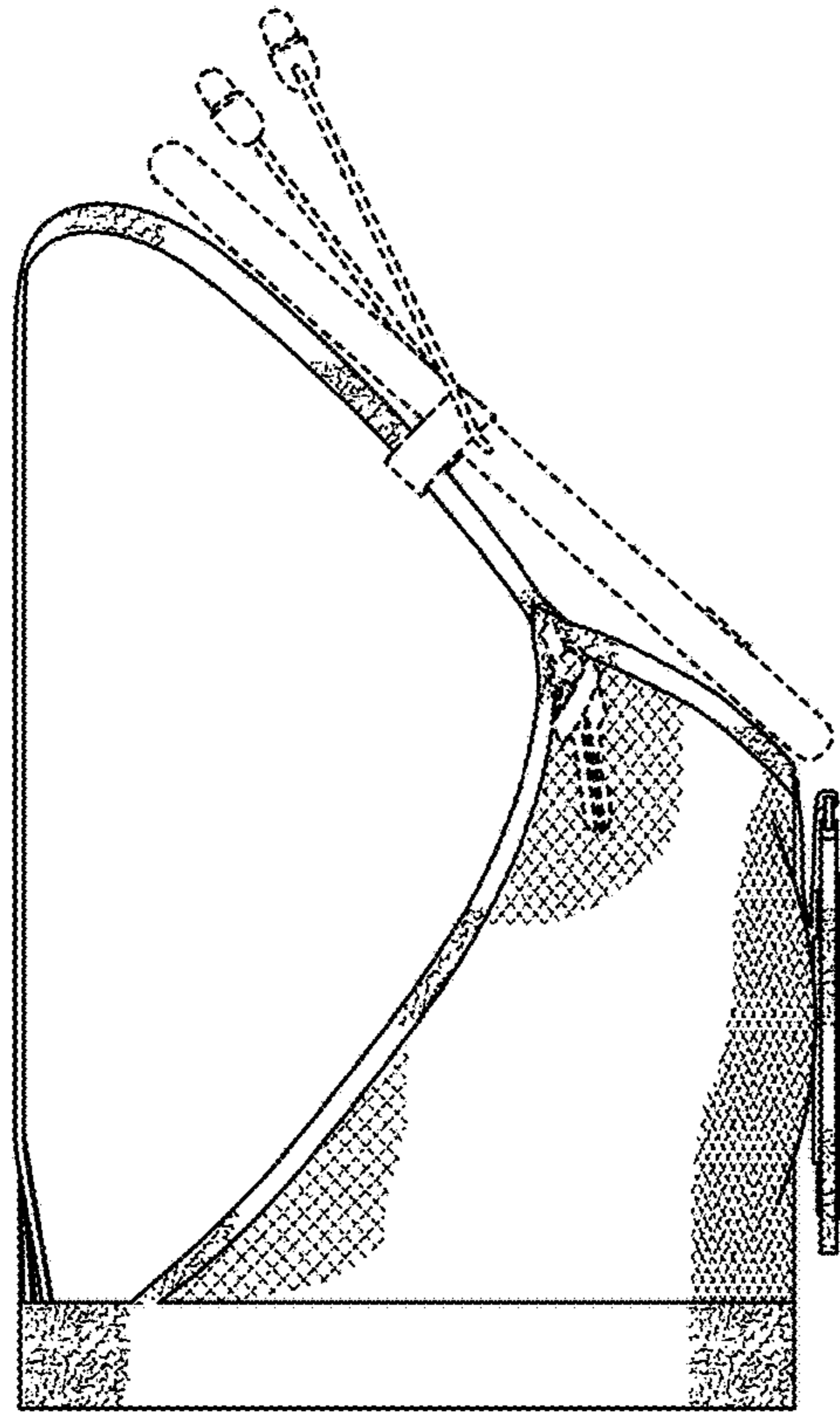

FIG. 6

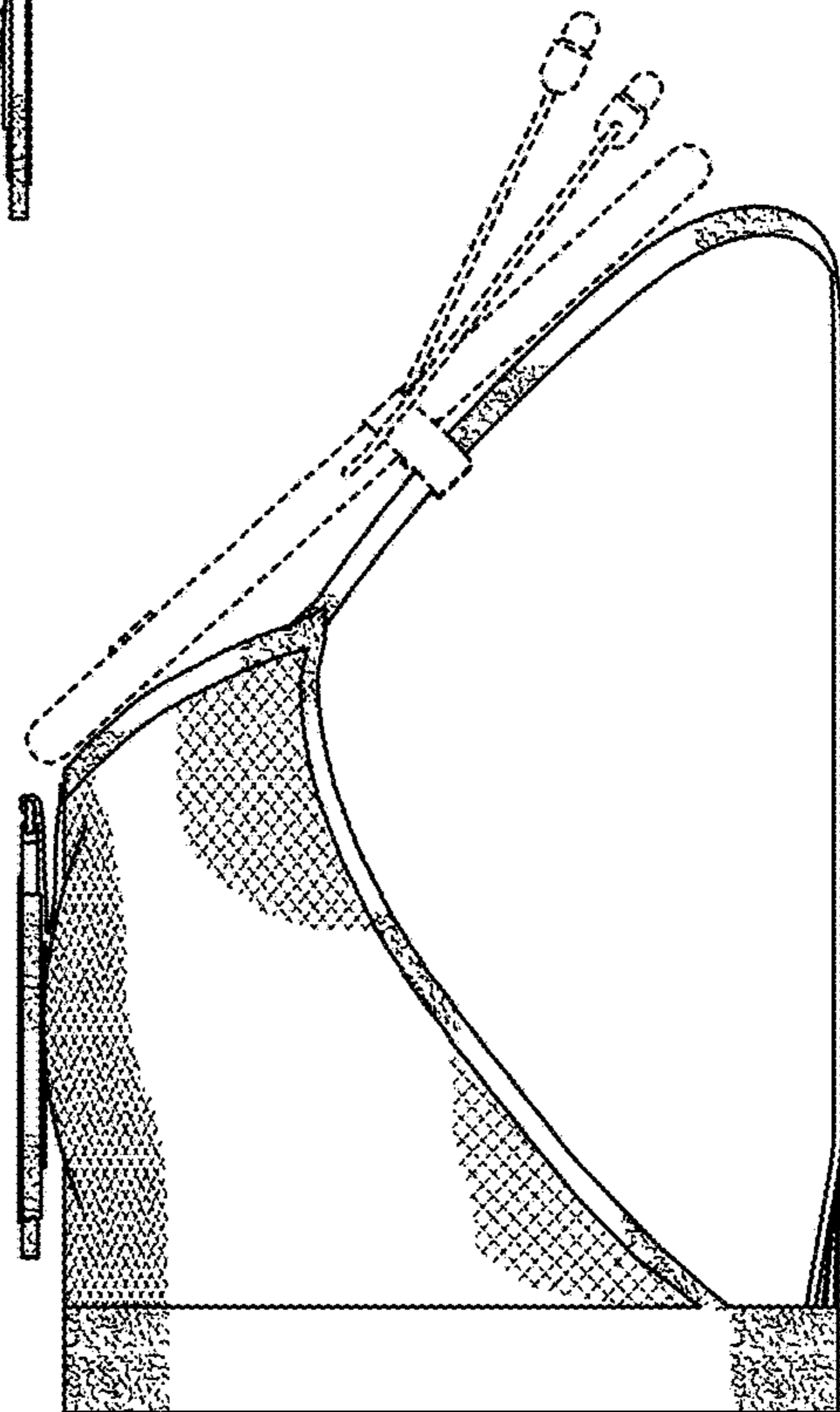

FIG. 7

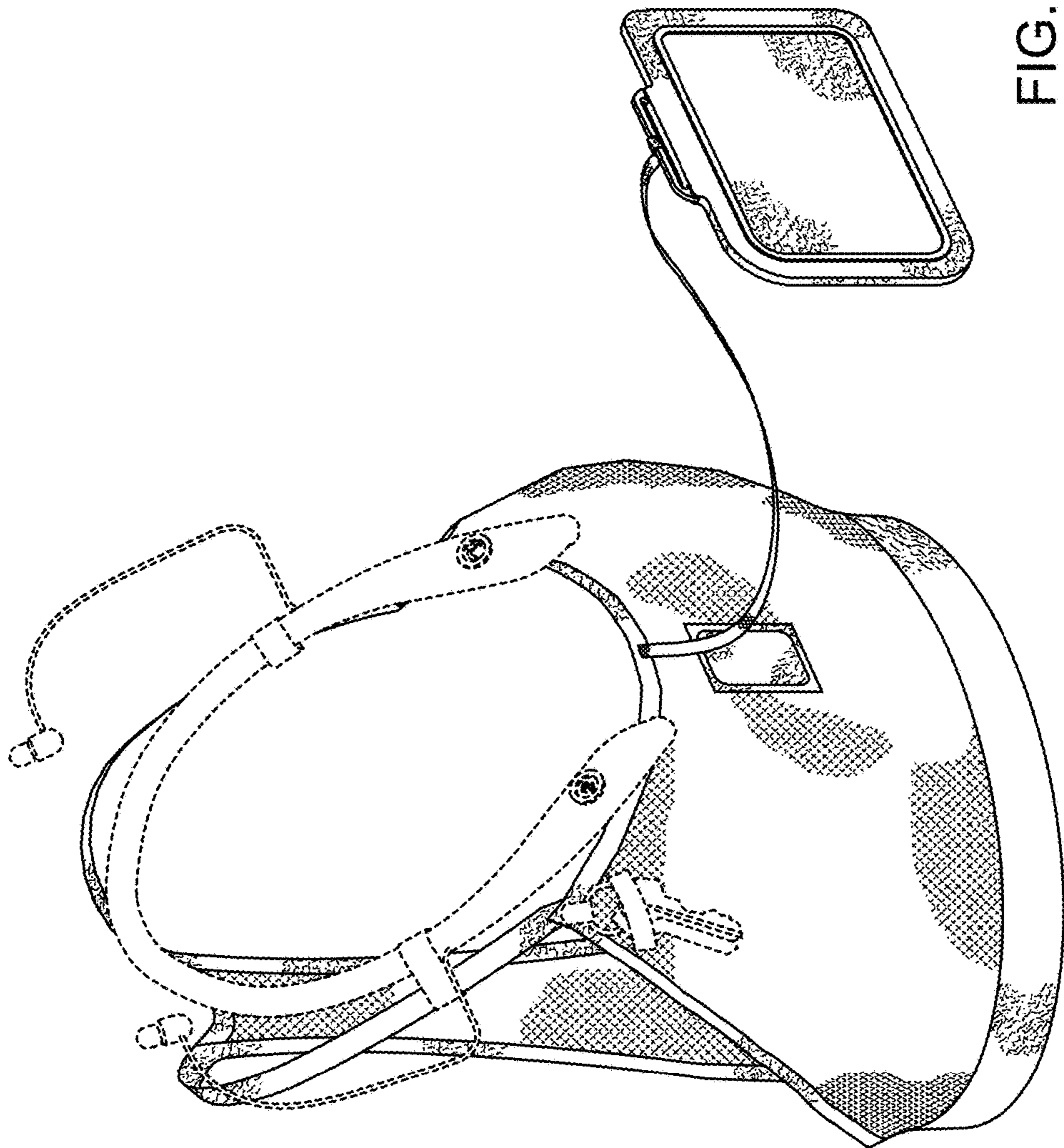

FIG. 8

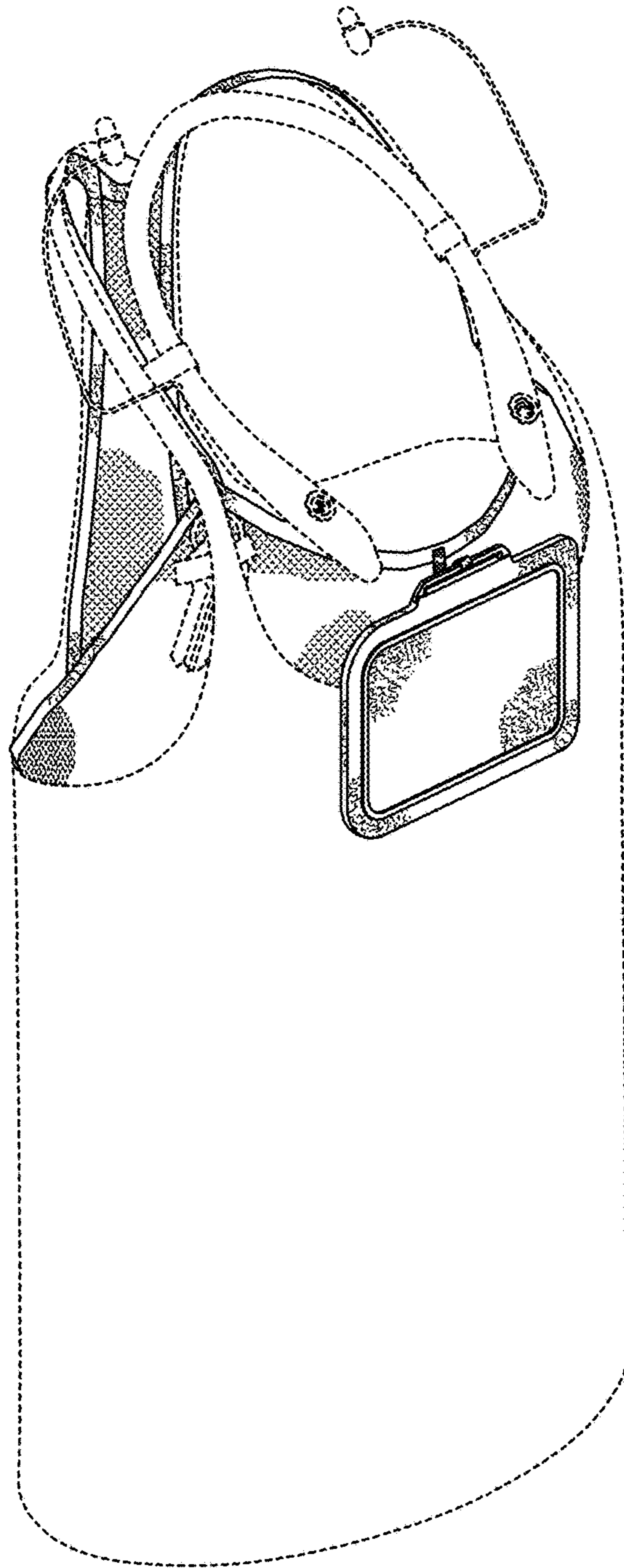

FIG. 9

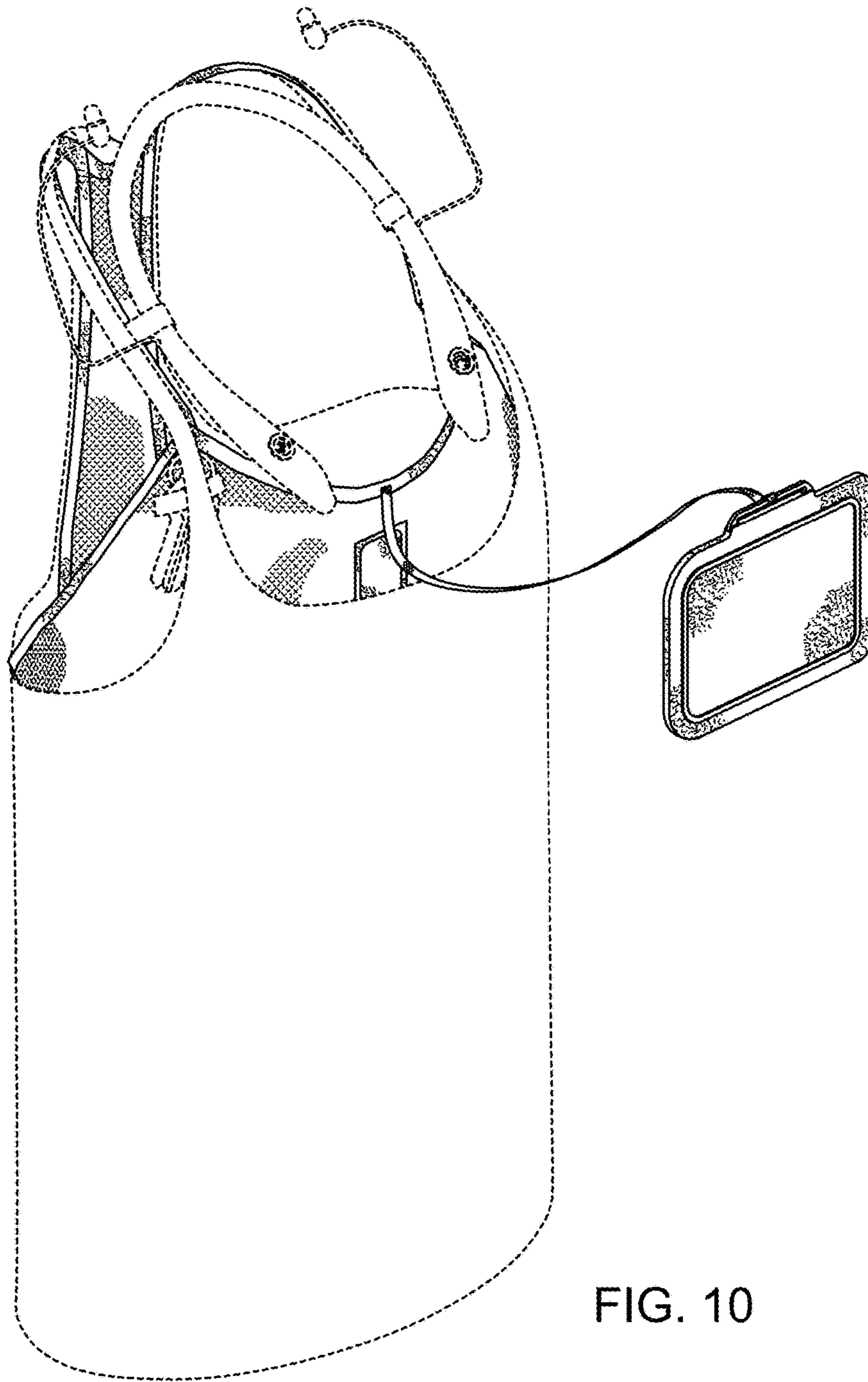

FIG. 10

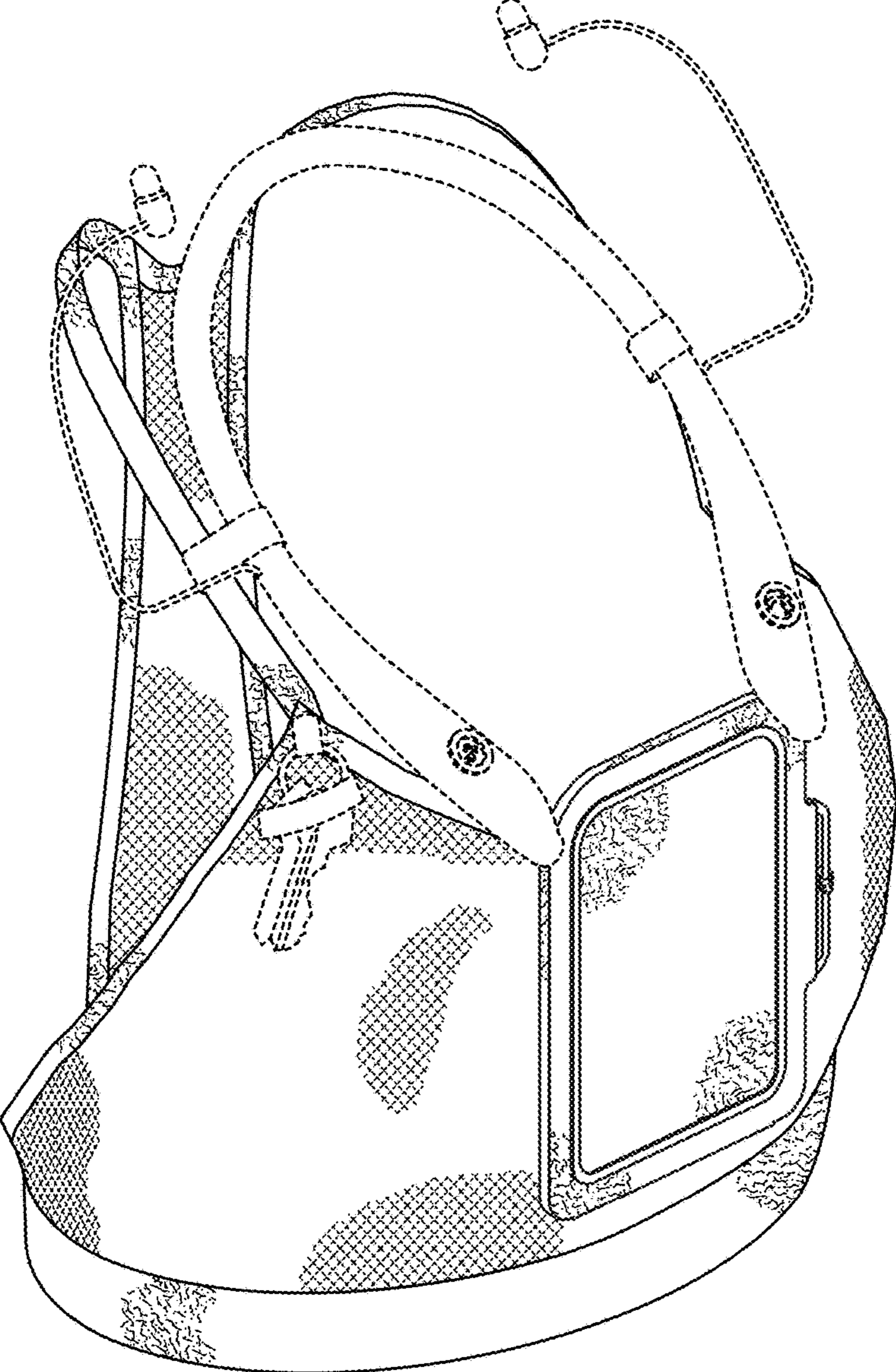

FIG. 11

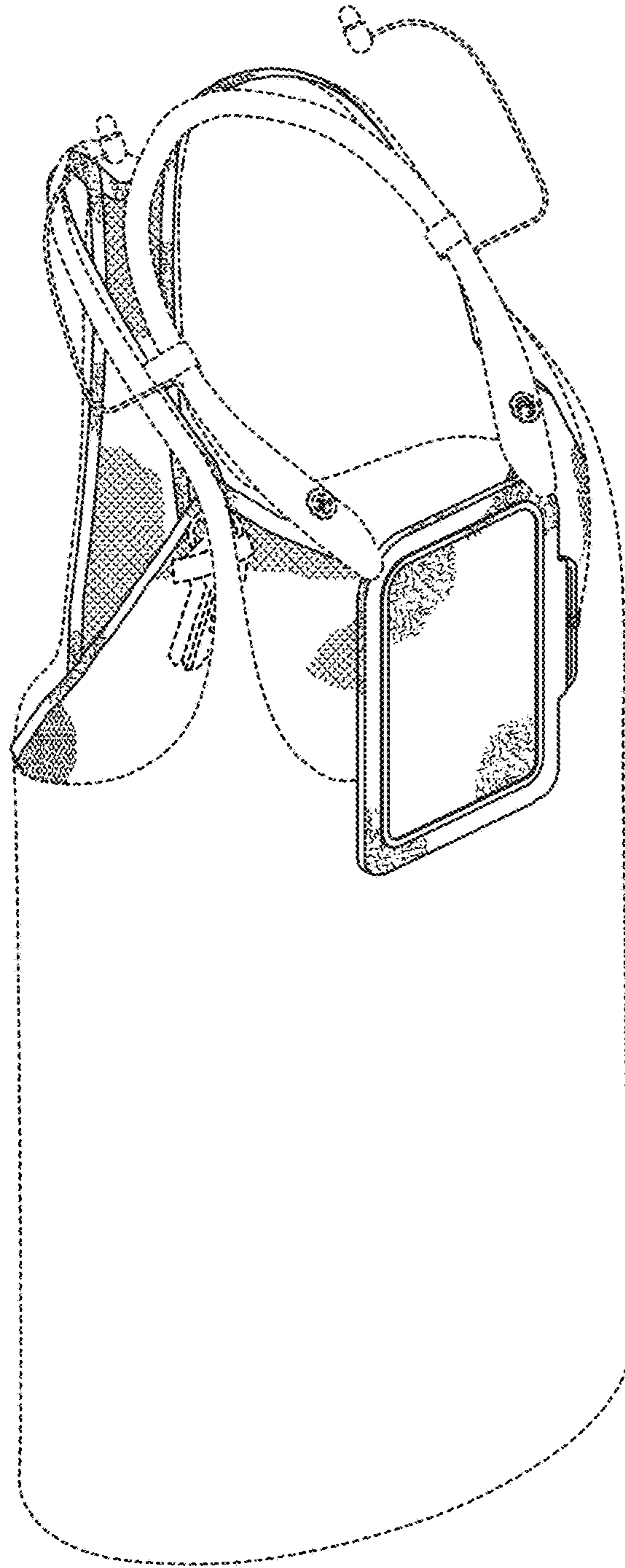

FIG. 12