



US00D849525S

(12) **United States Design Patent** (10) **Patent No.:** **US D849,525 S**  
**Treat et al.** (45) **Date of Patent:** **\*\* May 28, 2019**

- (54) **DISPLAY PACKAGING**
- (71) Applicant: **Jasco Products Company LLC**,  
Oklahoma City, OK (US)
- (72) Inventors: **Jon Treat**, Edmond, OK (US);  
**Cameron Trice**, Oklahoma City, OK  
(US)
- (73) Assignee: **Jasco Products Company LLC**,  
Oklahoma City, OK (US)
- (\*\*) Term: **15 Years**
- (21) Appl. No.: **29/634,085**
- (22) Filed: **Jan. 18, 2018**
- (51) **LOC (11) Cl.** ..... **09-03**
- (52) **U.S. Cl.**  
USPC ..... **D9/418; D9/415**
- (58) **Field of Classification Search**  
USPC ..... D9/414, 415, 418, 419, 431, 432, 499  
CPC ... B65D 5/00; B65D 5/18; B65D 5/20; B65D  
5/42; B65D 5/061; B65D 5/008; B65D  
5/422; B65D 5/4204; B65D 5/4225;  
B65D 25/54; B65D 33/04; B65D 33/14;  
B42D 15/02; A45D 40/221  
See application file for complete search history.

- (56) **References Cited**  
U.S. PATENT DOCUMENTS

D261,616 S	11/1981	Tesar	
D265,551 S	7/1982	Colby	
D271,943 S	12/1983	Beise	
4,457,431 A *	7/1984	Lundquist	..... B65D 5/42 229/100
D293,212 S	12/1987	Zuliani	
D468,638 S *	1/2003	Nogami	..... D9/423
D485,172 S *	1/2004	Defino, Jr.	..... D9/415
D518,368 S *	4/2006	Tachikawa	..... D9/415
D525,864 S	8/2006	Hiolin	

- D557,135 S \* 12/2007 Demalsche ..... D9/418
- D564,872 S \* 3/2008 Kamins ..... D9/418
- D578,875 S 10/2008 Kent
- D600,110 S \* 9/2009 Cain ..... D9/418
- D614,022 S 4/2010 Melnick
- D618,543 S \* 6/2010 Polaski ..... D9/418
- D628,882 S \* 12/2010 Work ..... D9/418
- D630,503 S \* 1/2011 Abdalkhani ..... D9/418
- D636,662 S \* 4/2011 Ignacio ..... D9/418
- D636,663 S \* 4/2011 Work ..... D9/418
- D637,073 S 5/2011 Morcos
- D639,652 S \* 6/2011 Abdalkhani ..... D9/418
- D652,321 S 1/2012 Melnick
- D681,444 S \* 5/2013 Oja ..... D9/418
- D699,103 S \* 2/2014 Rathbone ..... D9/418
- D702,546 S \* 4/2014 McAdam ..... D9/418
- D712,275 S \* 9/2014 Irek ..... D9/418
- D712,276 S \* 9/2014 Irek ..... D9/418

(Continued)

*Primary Examiner* — Wan Laymon  
*Assistant Examiner* — Clint A Samuel  
(74) *Attorney, Agent, or Firm* — Bruce P. LaBrie;  
Resolution Legal Group

(57) **CLAIM**  
The ornamental design for display packaging, as shown and described.

**DESCRIPTION**  
FIG. 1 is a front elevational view of display packaging showing our new design;  
FIG. 2 is a right elevational view thereof;  
FIG. 3 is a left elevational view thereof;  
FIG. 4 is a rear elevational view thereof;  
FIG. 5 is a top plan view thereof;  
FIG. 6 is a bottom plan view thereof; and,  
FIG. 7 is a perspective view thereof.  
The structural features depicted by broken lines have been shown for the purpose of illustrating portions of display packaging that form no part of the claimed design.

**1 Claim, 6 Drawing Sheets**

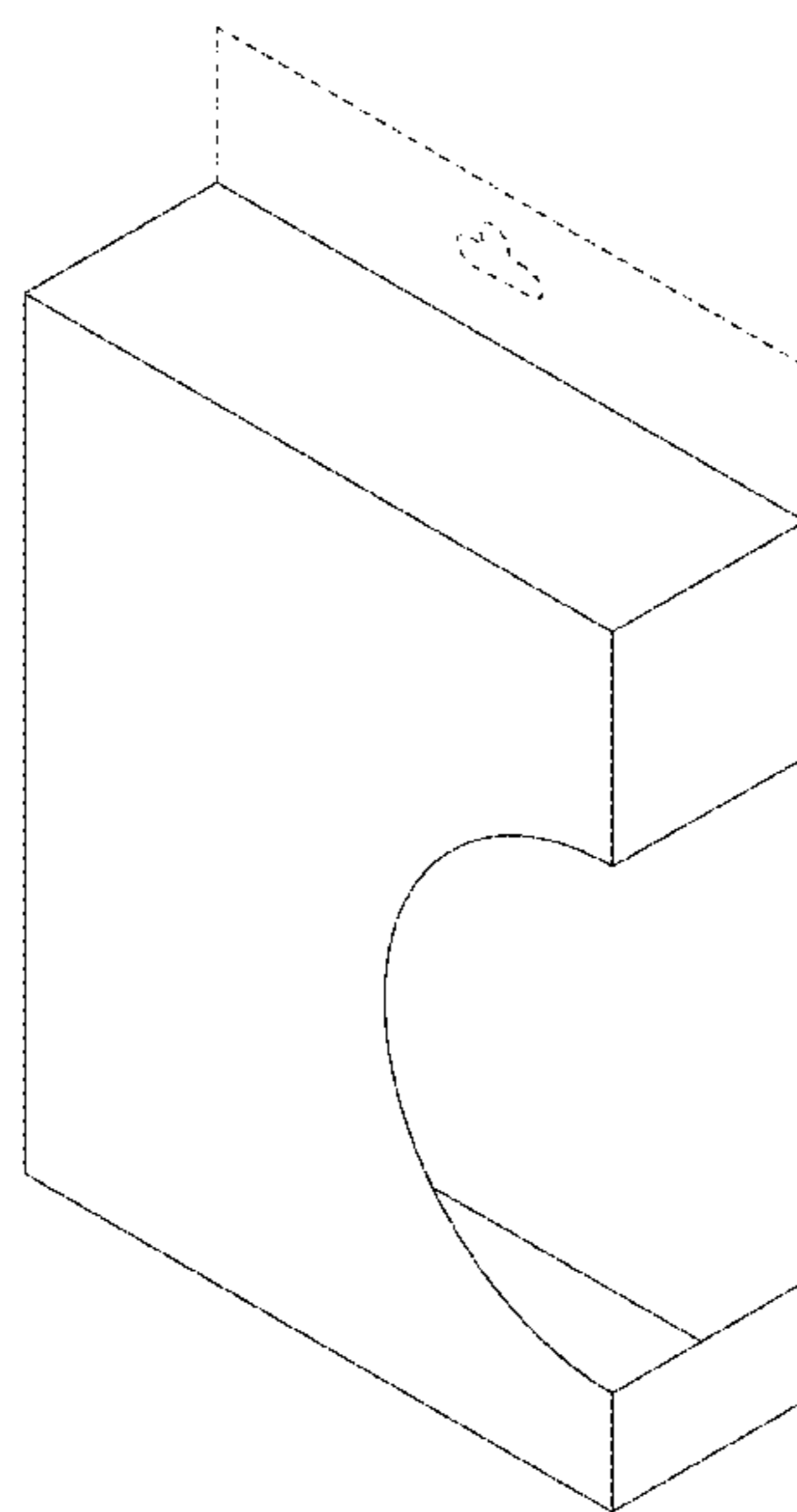

(56)

**References Cited**

U.S. PATENT DOCUMENTS

D738,716	S	*	9/2015	Nettenstrom	.....	D9/418
D755,044	S	*	5/2016	Nettenstrom	.....	D9/418
D758,841	S	*	6/2016	Russo	.....	D9/415
D762,465	S	*	8/2016	Popper	.....	D9/415
D765,500	S	*	9/2016	Brown	.....	D9/415
9,457,946	B2	*	10/2016	Lopez	.....	B65D 5/422
D797,550	S	*	9/2017	Fath	.....	D9/418
D804,298	S	*	12/2017	Demmink	.....	D9/418
D822,480	S	*	7/2018	Rivera	.....	D9/418
D822,481	S	*	7/2018	Rivera	.....	D9/418
D823,119	S	*	7/2018	Louw	.....	D9/600

\* cited by examiner

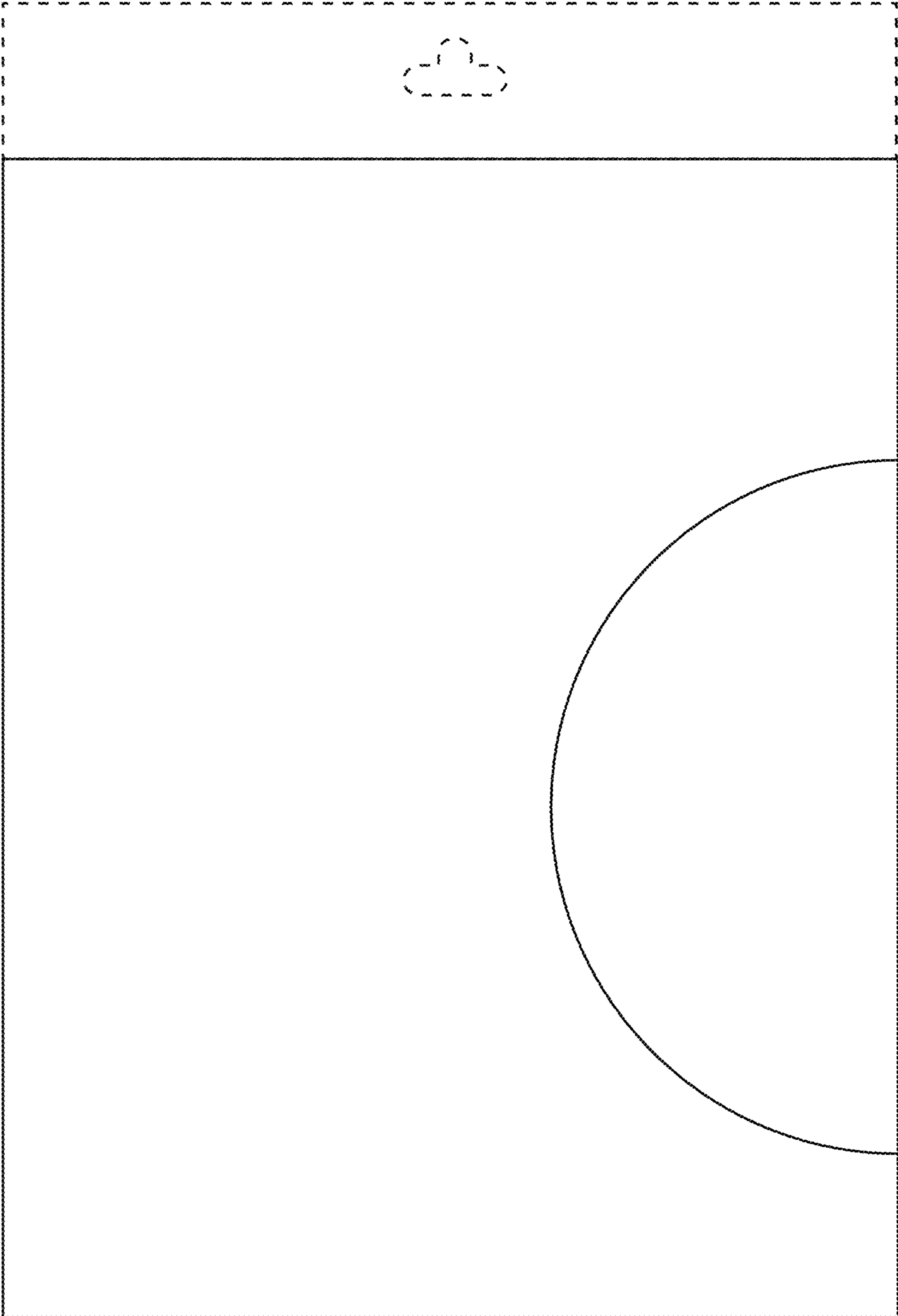

FIG. 1

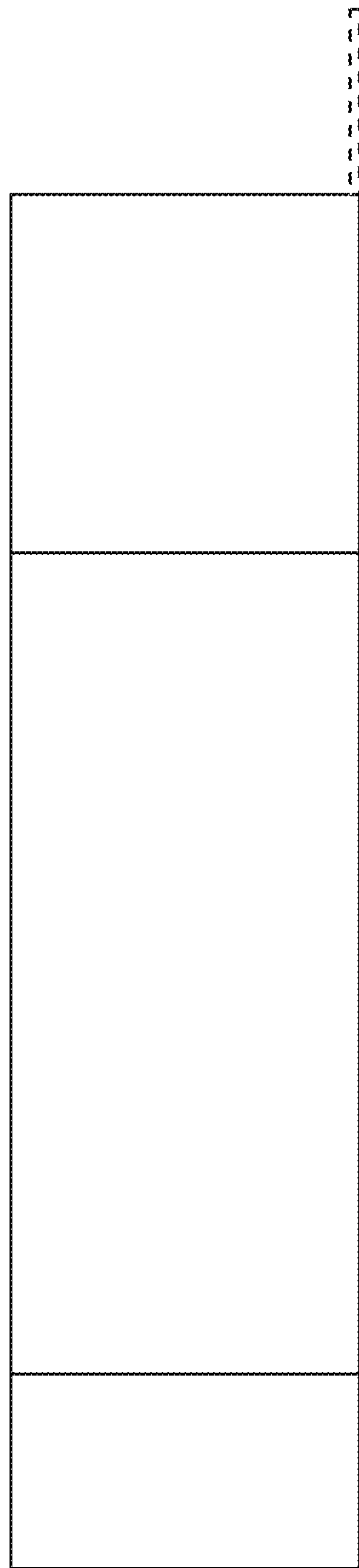

FIG. 2

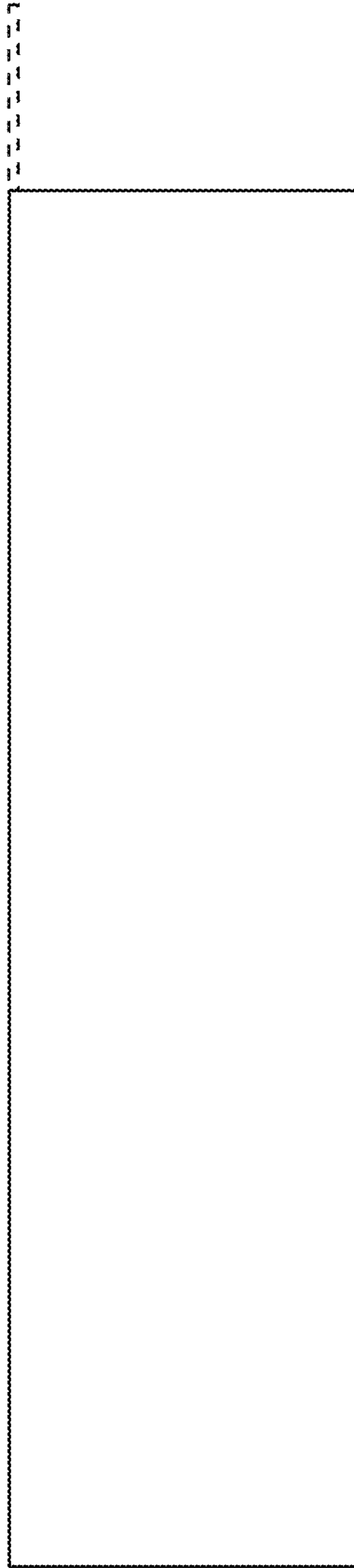

FIG. 3

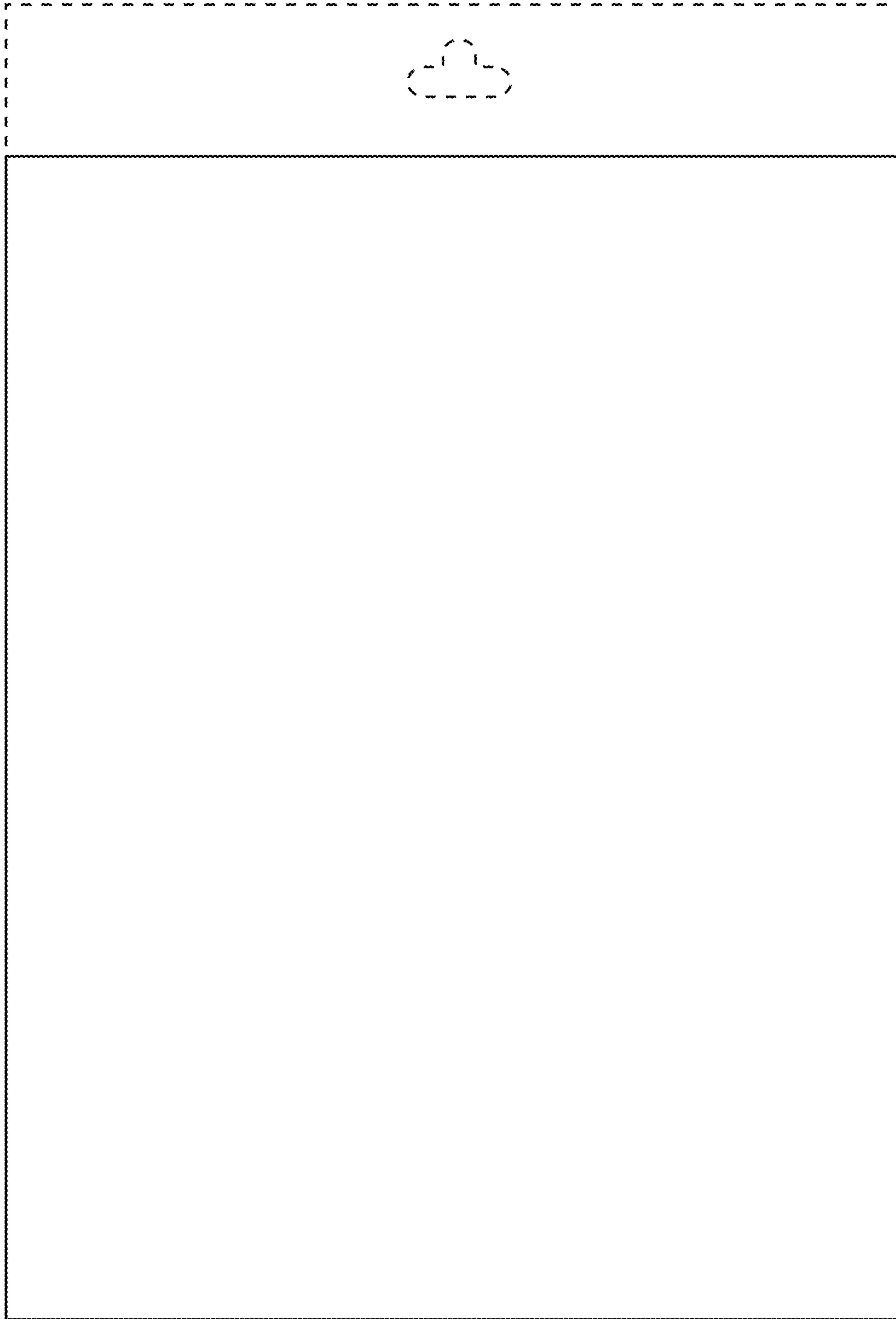

FIG. 4

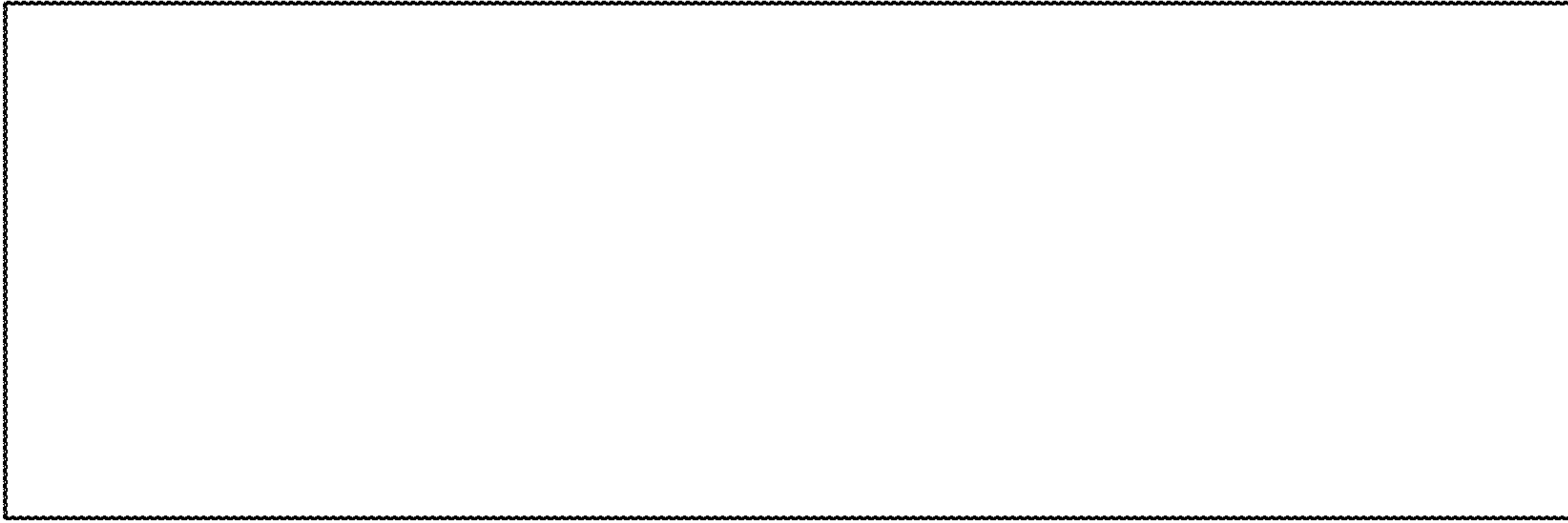

FIG. 5

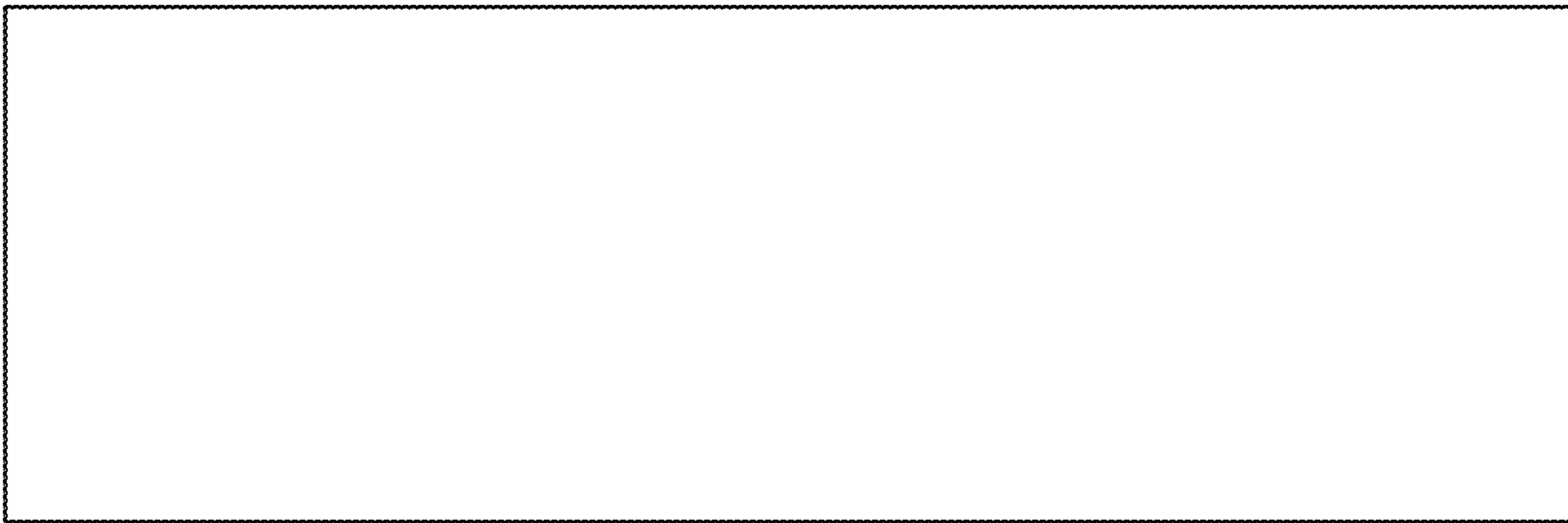

FIG. 6

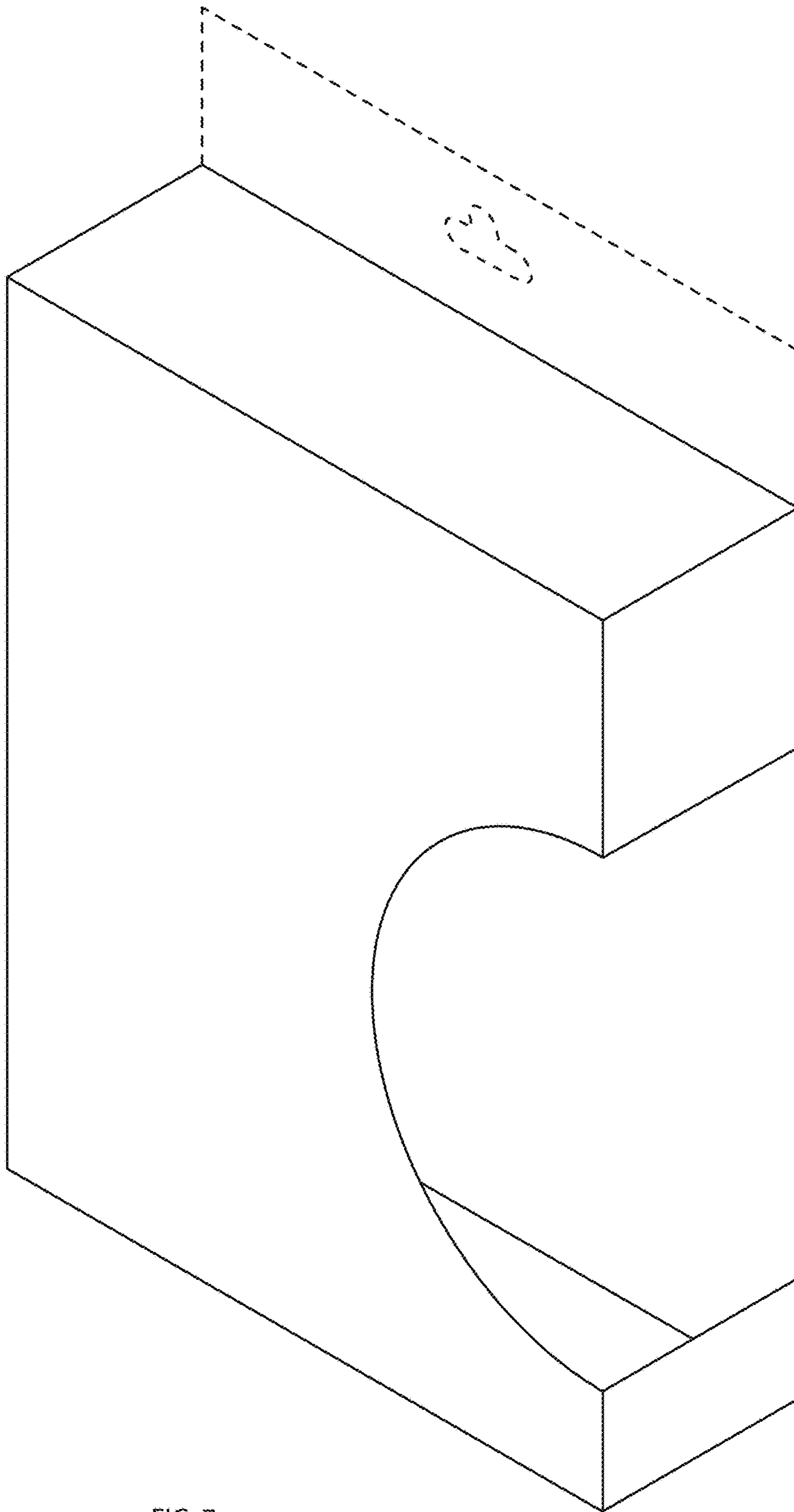

FIG. 7