

US00D849479S

(12) **United States Design Patent** (10) **Patent No.:** **US D849,479 S**
Sloyer (45) **Date of Patent:** **** May 28, 2019**

(54) **COOKTOP RANGE PAN**
(71) Applicant: **Hestan Commercial Corporation,**
Anaheim, CA (US)
(72) Inventor: **Jairad Sloyer,** Rancho Santa Margarita,
CA (US)
(73) Assignee: **Meyer Intellectual Properties Limited**
(VG)
(**) Term: **15 Years**
(21) Appl. No.: **29/629,945**
(22) Filed: **Dec. 18, 2017**
(51) **LOC (11) Cl.** **07-02**
(52) **U.S. Cl.**
USPC **D7/407**
(58) **Field of Classification Search**
USPC D7/332-337, 339-341, 346-349,
D7/354-356, 362, 363, 366, 367, 396.1,
D7/402-407
CPC F23D 14/00; F23D 14/02; F23D 14/04;
F24C 3/08; H05B 2213/07; H05B 3/68
See application file for complete search history.

D320,531 S * 10/1991 Schweitzer D7/402
D406,722 S * 3/1999 Benton D7/337
D544,292 S * 6/2007 Lion D7/354
D620,305 S * 7/2010 Tosdale D7/354
D666,055 S * 8/2012 O'Neil D7/407
D826,626 S * 8/2018 Lee D7/362
D826,627 S * 8/2018 Lee D7/362

* cited by examiner

Primary Examiner — Sheryl Lane
Assistant Examiner — Nicole C Shiflet
(74) *Attorney, Agent, or Firm* — Edward S. Sherman

(57) **CLAIM**

The ornamental design for a cooktop range pan, as shown and described.

DESCRIPTION

FIG. 1 is an upper perspective view of the cooktop range pan showing my new design;
FIG. 2 is a top plan view thereof;
FIG. 3 is front-side elevation view, the back-side elevation view being the mirror image thereof.
FIG. 4 is a right-side elevation view, the left side elevation view being the mirror image thereof;
FIG. 5 is a bottom plan view thereof; and,
FIG. 6 is a bottom perspective view thereof.
The broken lines in FIG. 1-6 form no part of the claimed design.

(56) **References Cited**
U.S. PATENT DOCUMENTS
D89,875 S * 5/1933 Corbishley D7/407
D92,481 S * 6/1934 Maul 126/214 D

1 Claim, 5 Drawing Sheets

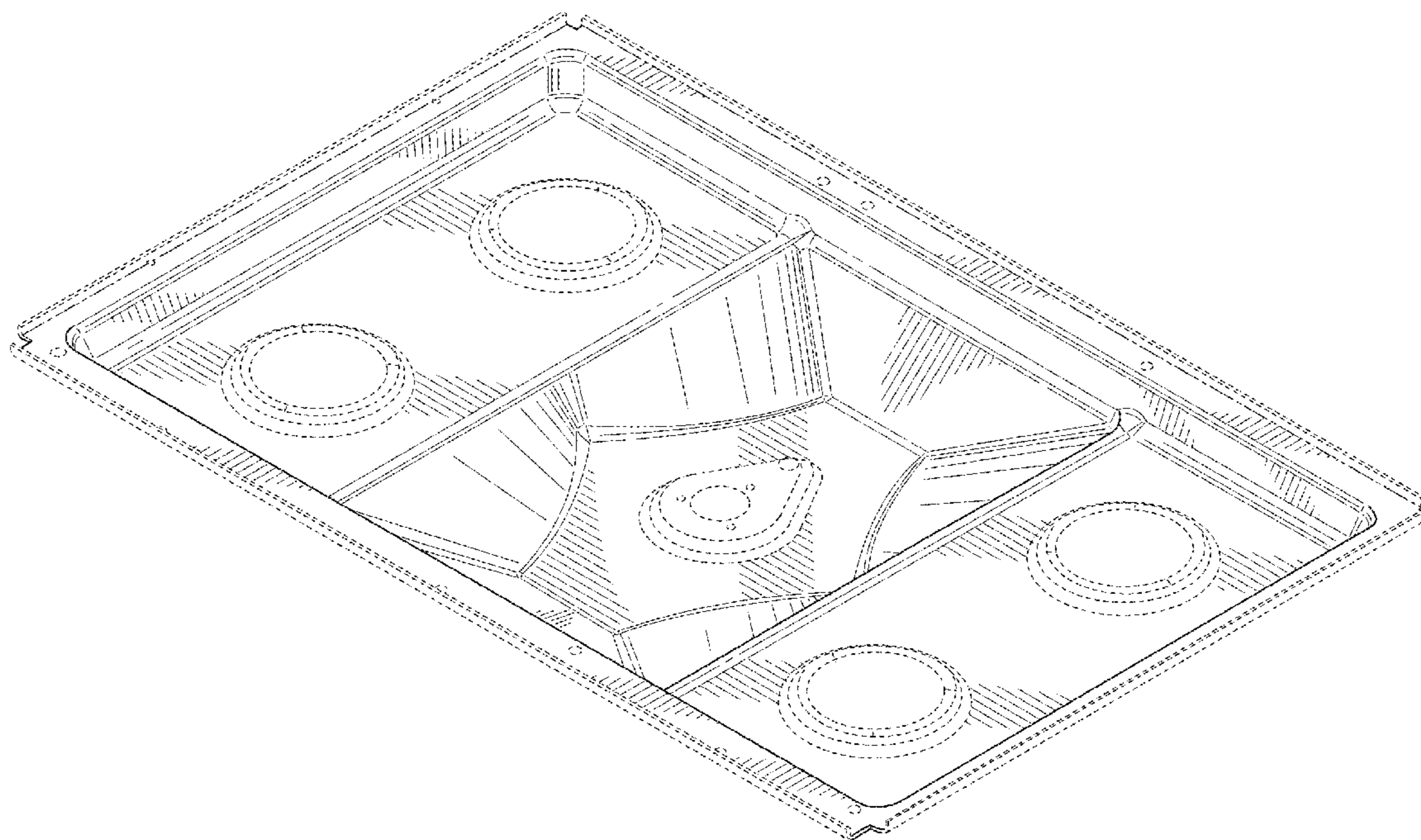

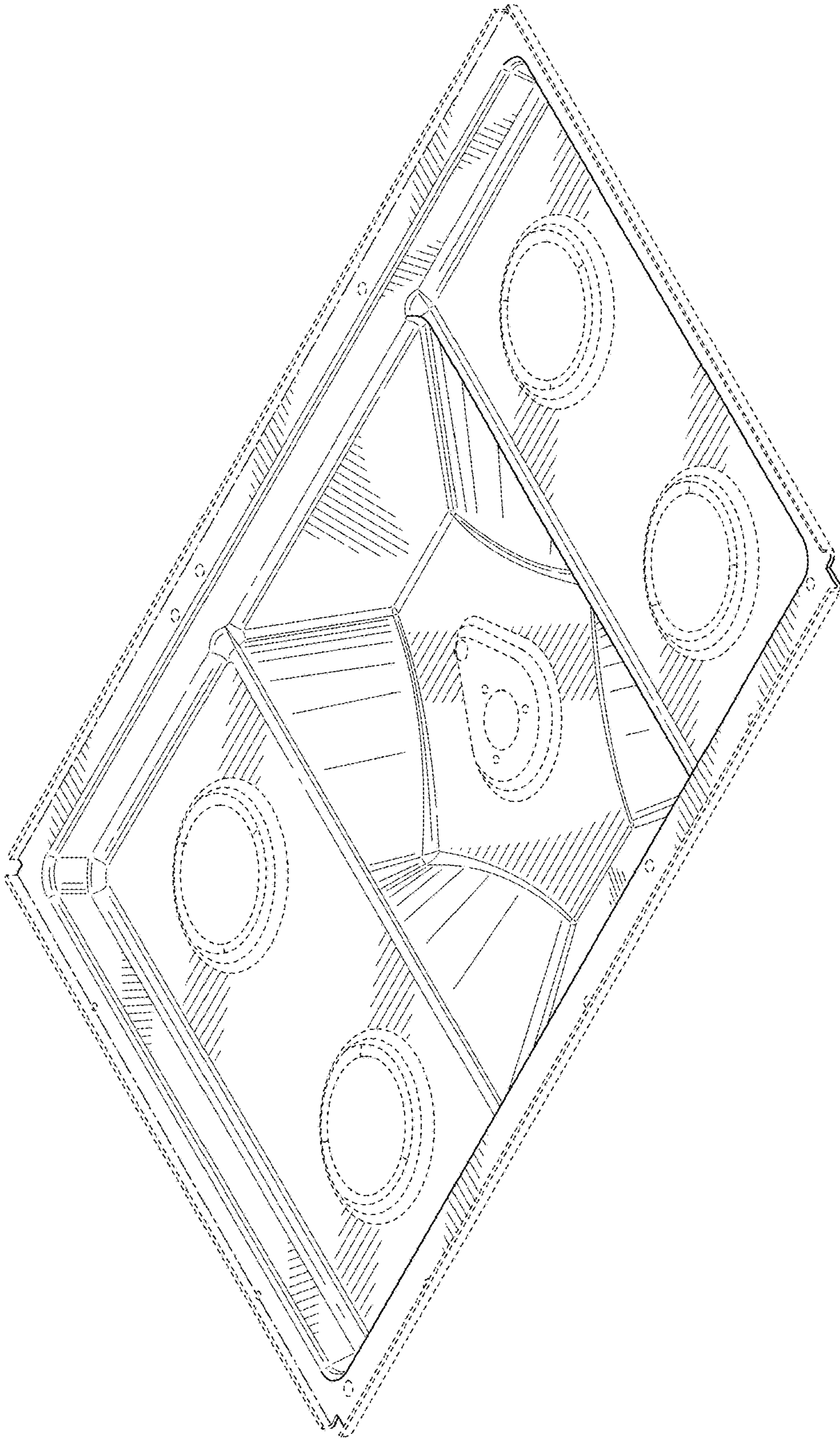

FIG. 1

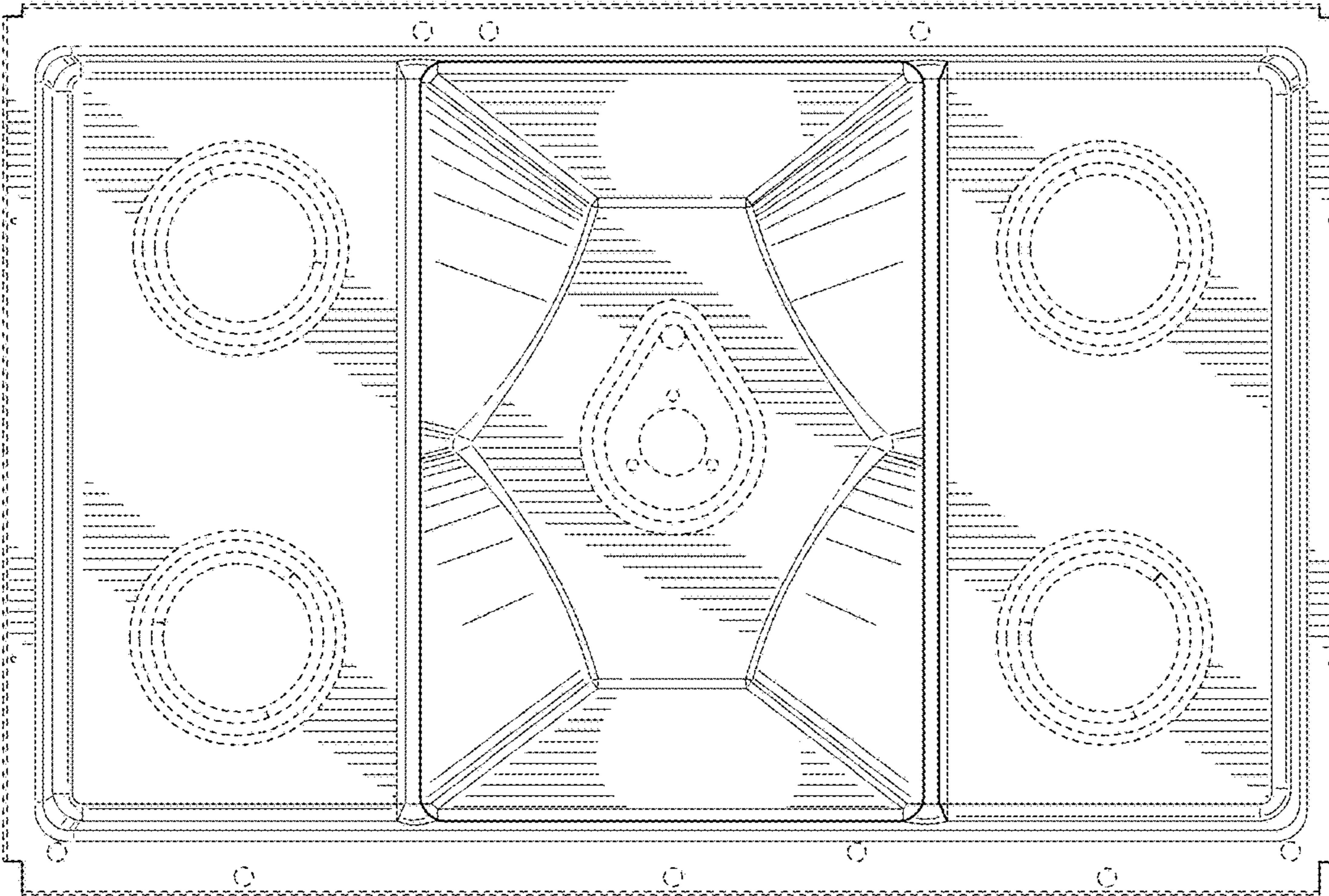

FIG. 2

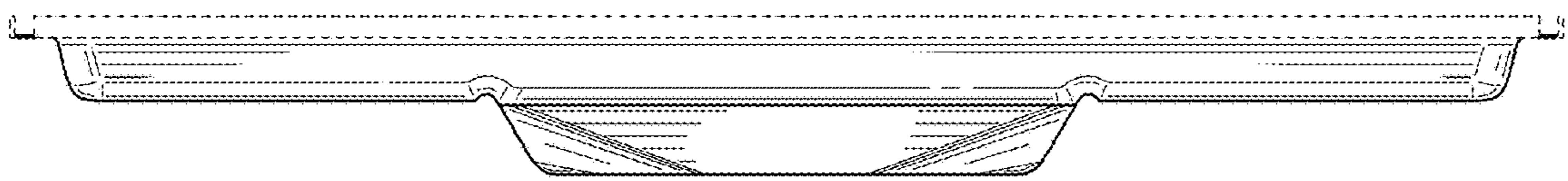

FIG. 3

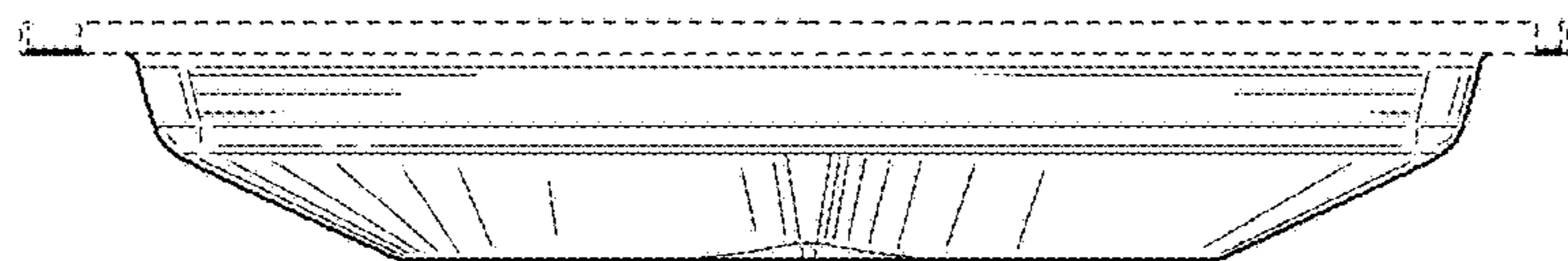

FIG. 4

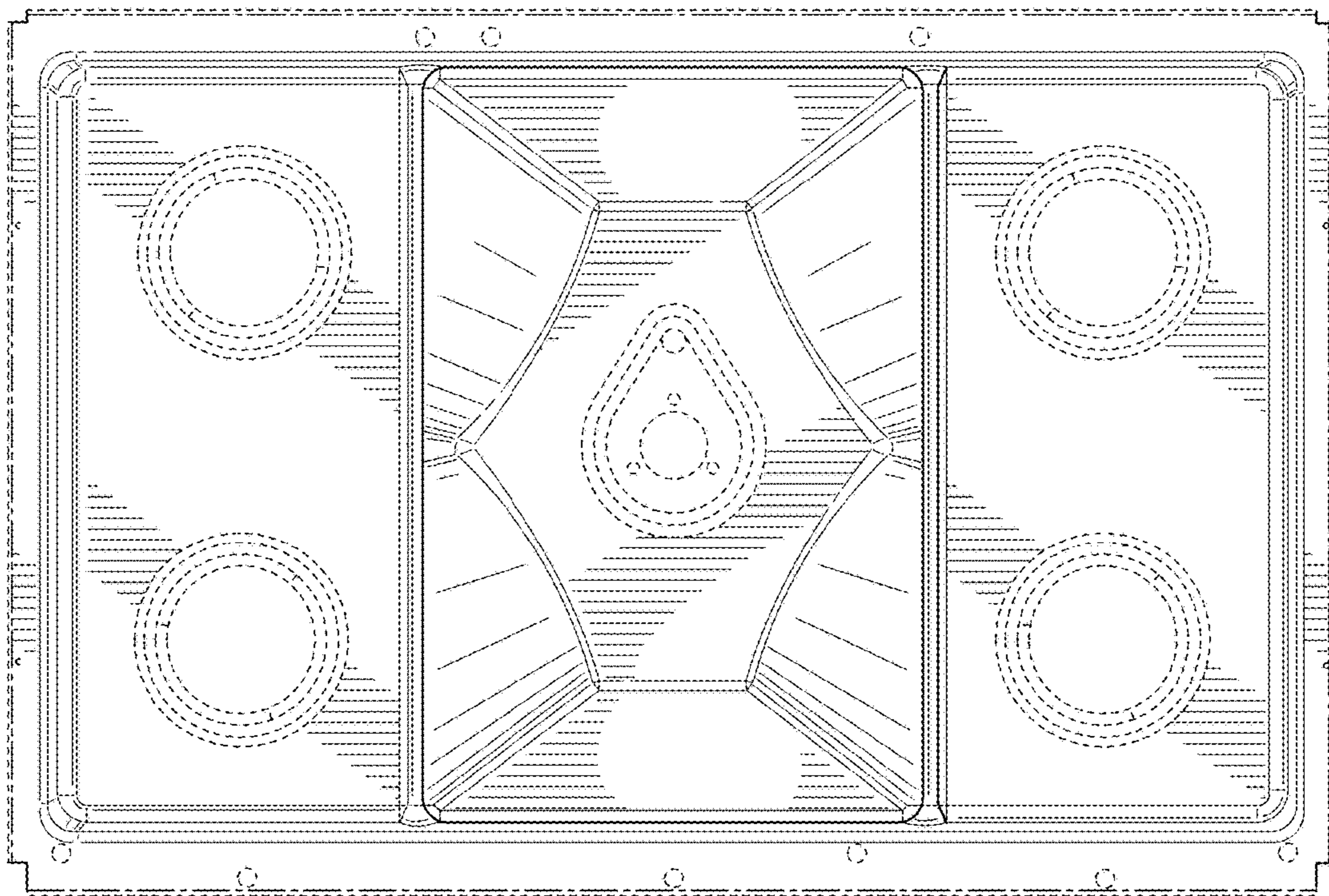

FIG. 5

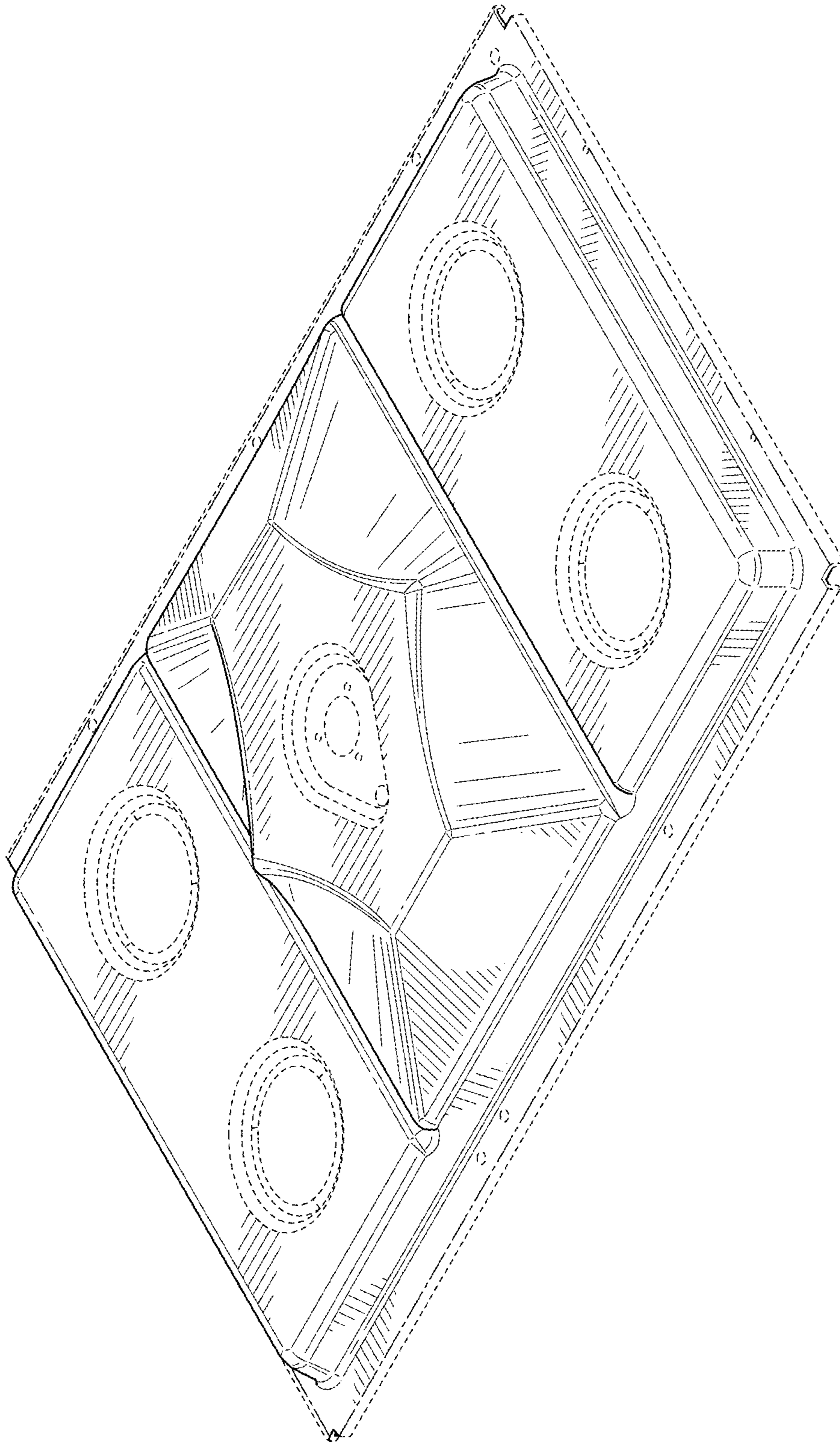

FIG. 6