



US00D849359S

(12) **United States Design Patent** (10) **Patent No.:** **US D849,359 S**
Jackson (45) **Date of Patent:** **** May 28, 2019**

(54) **HEATED GLOVE**
(71) Applicant: **Aaron L. Jackson**, Gautier, MS (US)
(72) Inventor: **Aaron L. Jackson**, Gautier, MS (US)
(**) Term: **15 Years**
(21) Appl. No.: **29/627,944**
(22) Filed: **Nov. 30, 2017**
(51) **LOC (11) Cl.** **02-06**
(52) **U.S. Cl.**
USPC **D2/617**
(58) **Field of Classification Search**
USPC D2/610, 617, 619, 620
CPC B29L 2031/4864; A41D 19/00; A41D
19/01535
See application file for complete search history.

D512,549 S * 12/2005 Benjamin D2/614
7,307,242 B1 12/2007 Chen
D825,886 S * 8/2018 Jaeger D2/617
2007/0095808 A1 5/2007 Lacy, III
2016/0235139 A1* 8/2016 Gramlin A41D 19/01535

OTHER PUBLICATIONS

ActionHeat AA Battery Heated Gloves, posted at actionheat.com, posting date not given, [online], [site visited Sep. 20, 2018]. Available from Internet, URL: <https://actionheat.com/collections/heated-gloves/products/actionheat-aa-battery-heated-gloves-mens> (Year: 2018).*

(Continued)

Primary Examiner — George D. Kirschbaum
Assistant Examiner — Maria J Edwards

(57) **CLAIM**

The ornamental design for a heated glove, as shown and described.

DESCRIPTION

FIG. 1 is a back view of a heated glove showing my new design;
FIG. 2 is a front view of the heated glove;
FIG. 3 is a right side side view of the heated glove;
FIG. 4 is a left side view of the heated glove;
FIG. 5 is a top view of the heated glove;
FIG. 6 is a bottom view of the heated glove;
FIG. 7 is a top back side perspective view of the heated glove; and,
FIG. 8 is a cross-sectional view of the heated glove taken along line 8-8 of FIG. 2.
The Figures depict a left hand embodiment, a right hand embodiment being a mirror image thereof. A wall thickness of the heated glove as shown in FIG. 8 is consistent throughout the body of the heated glove.

(56) **References Cited**
U.S. PATENT DOCUMENTS
1,284,378 A * 11/1918 Lemercier 219/211
2,451,758 A * 10/1948 Malm A41D 19/0062
2/168
D195,189 S * 5/1963 Schulte 340/321
3,121,877 A * 2/1964 Gintner A61B 42/10
2/159
4,021,640 A 5/1977 Gross et al.
4,488,726 A * 12/1984 Murray A63B 71/148
116/DIG. 44
4,764,665 A 8/1988 Orban et al.
4,950,868 A 8/1990 Moss et al.
5,782,516 A * 7/1998 Partida G11B 23/00
2/159
6,239,410 B1 5/2001 Tackore
D445,995 S 8/2001 Stanley
D488,284 S * 4/2004 Kavana D2/614
6,959,452 B2 * 11/2005 Bradbury A41D 19/0079
2/159

1 Claim, 6 Drawing Sheets

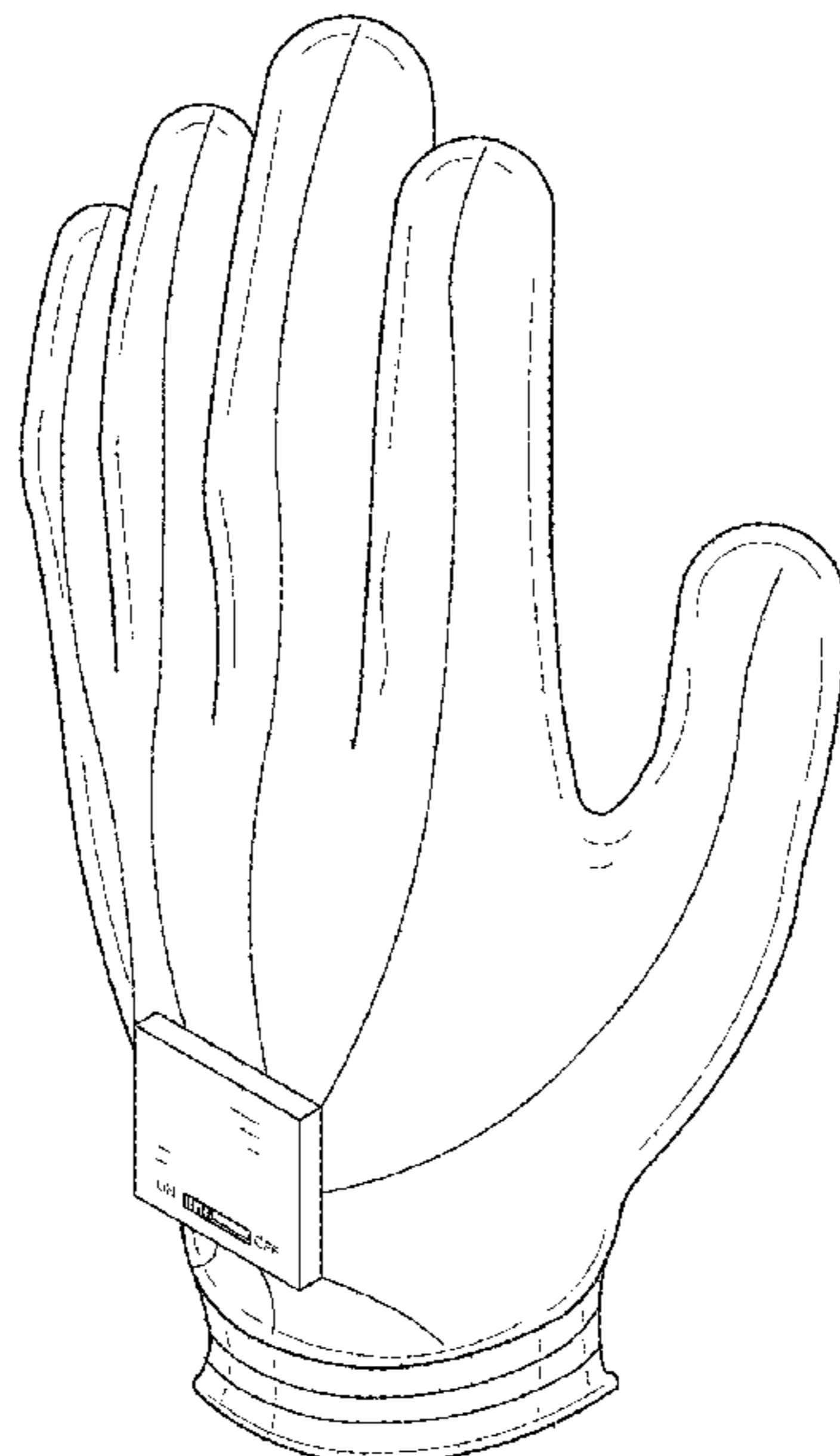

(56)

References Cited

OTHER PUBLICATIONS

Arthritis Compression Gloves, posted at amazon.com, posting date not given, [online], [site visited Sep. 20, 2018]. Available from Internet, URL: <https://www.amazon.com/Arthritis-Compression-Medicomat-15a-Arthritic-Treatment/dp/B00RHZ9ZKC> (Year: 2018).*

Next Generation AI Heated Glove Liner, posted at indiegogo.com, posting date not given, [online], [site visited Sep. 20, 2018]. Available from Internet, URL: <https://www.indiegogo.com/projects/next-generation-ai-technology-heated-glove-liner#/> (Year: 2018).*

Warmawear Battery Heated Glove Liners, posted at amazon.com, posting date Jan. 1, 2018, [online], [site visited Sep. 20, 2018]. Available from Internet, URL: <https://www.amazon.com/Warmawear-Weather-Battery-Heated-Liners/dp/B075LPMJC8> (Year: 2018).*

* cited by examiner

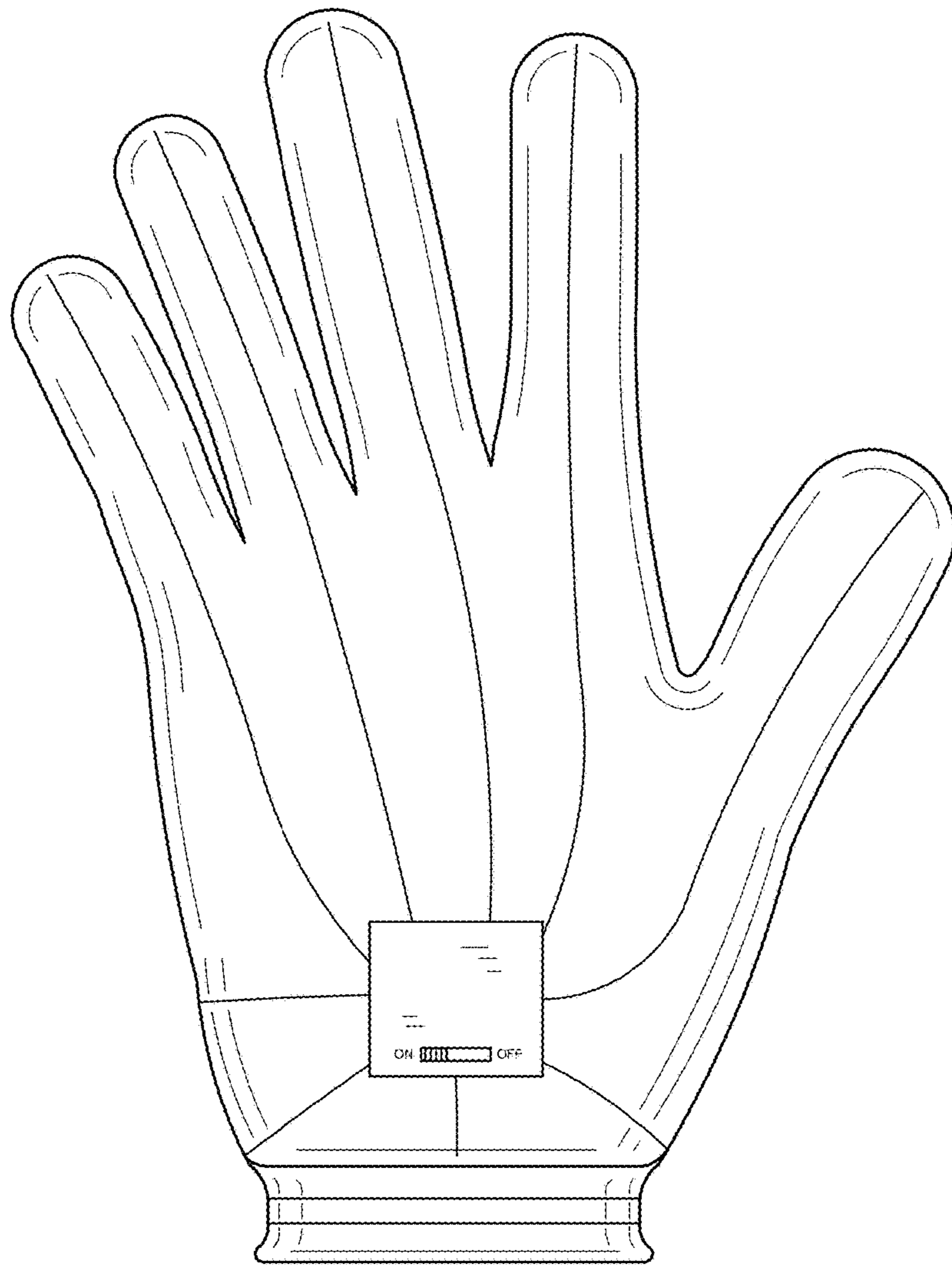

FIG. 1

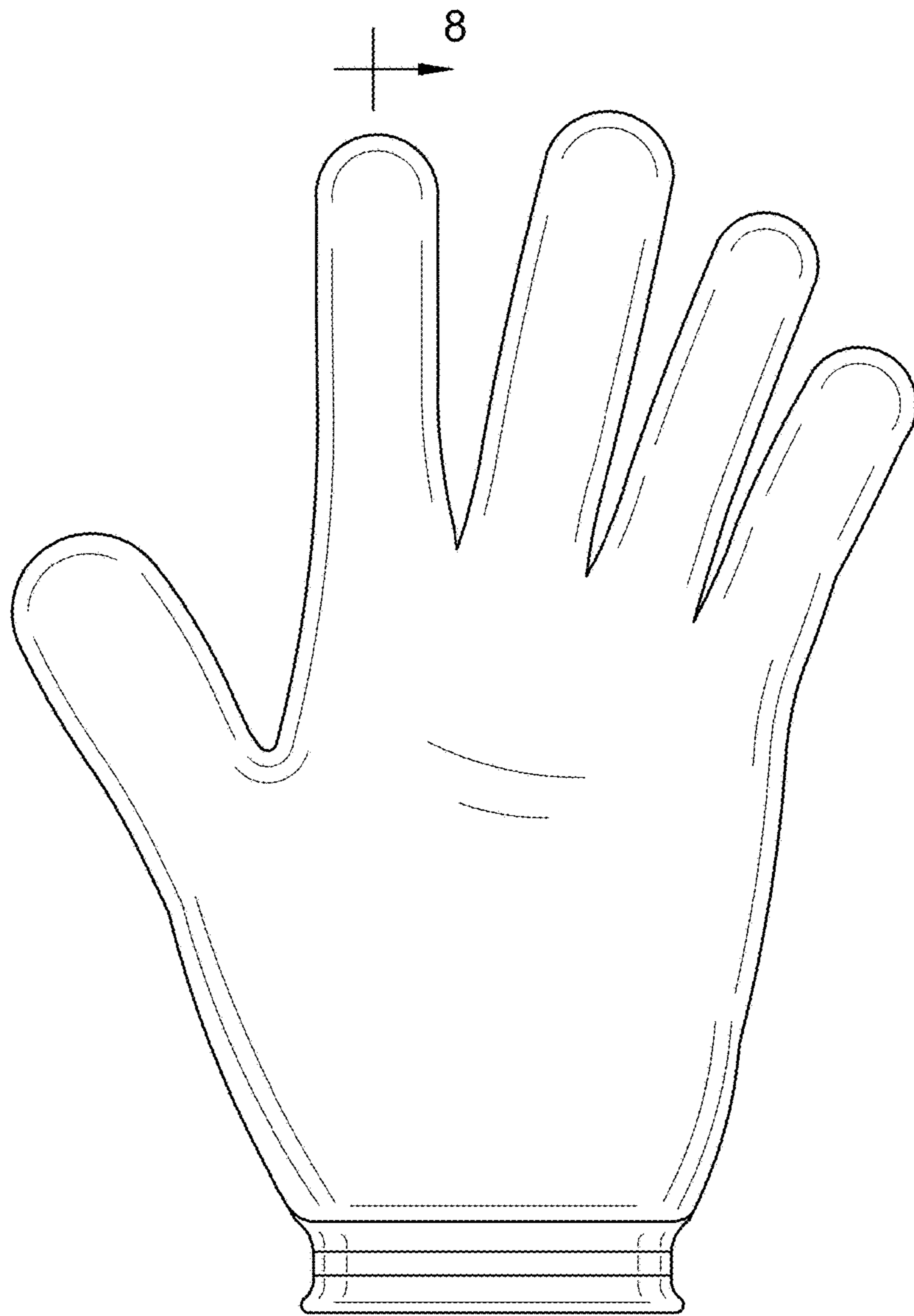
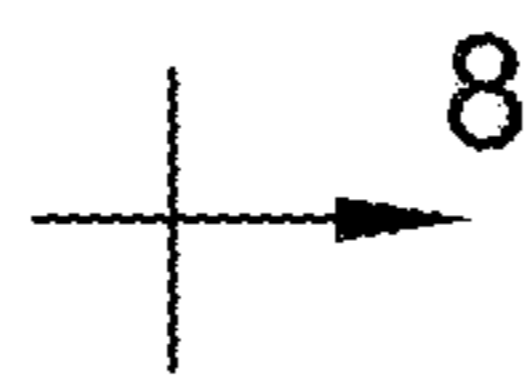

FIG. 2



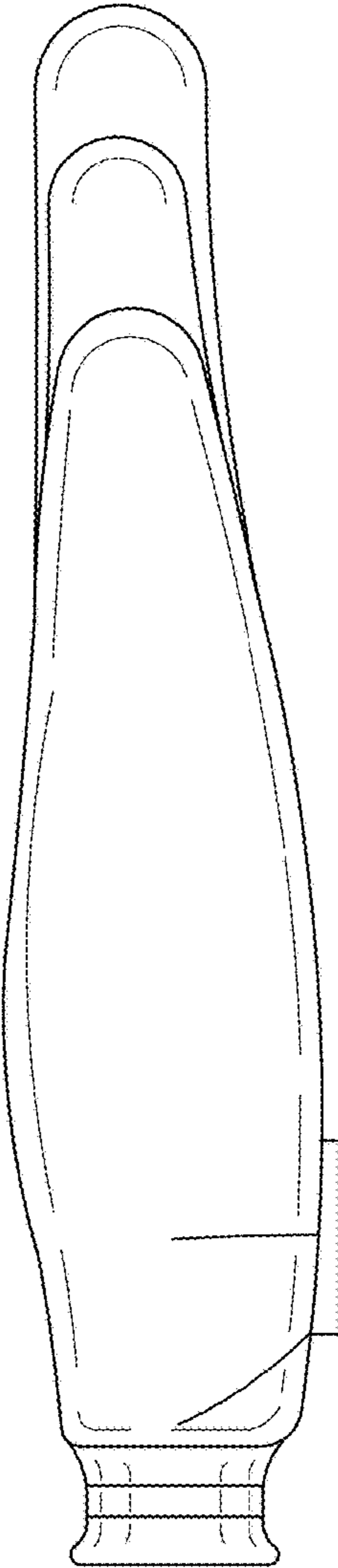

FIG. 3

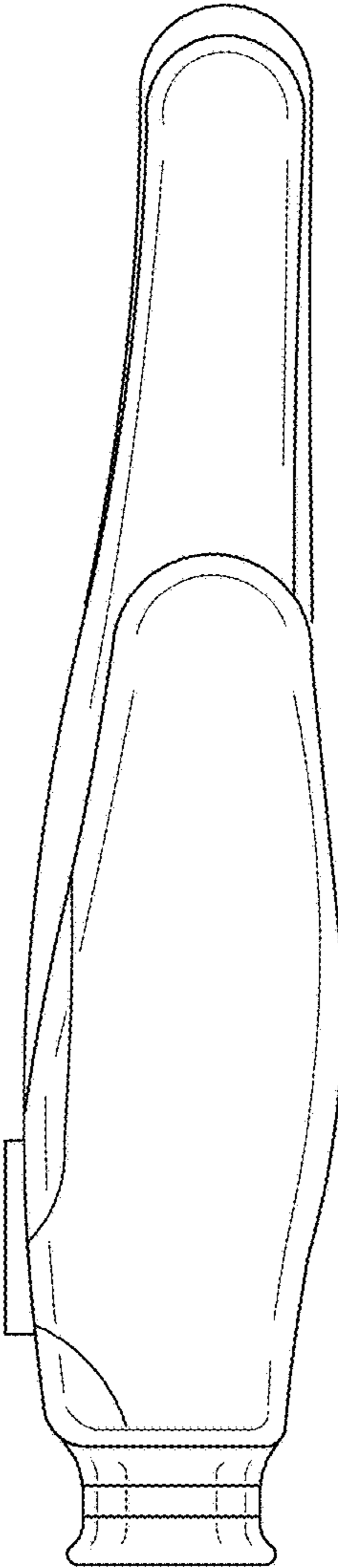

FIG. 4

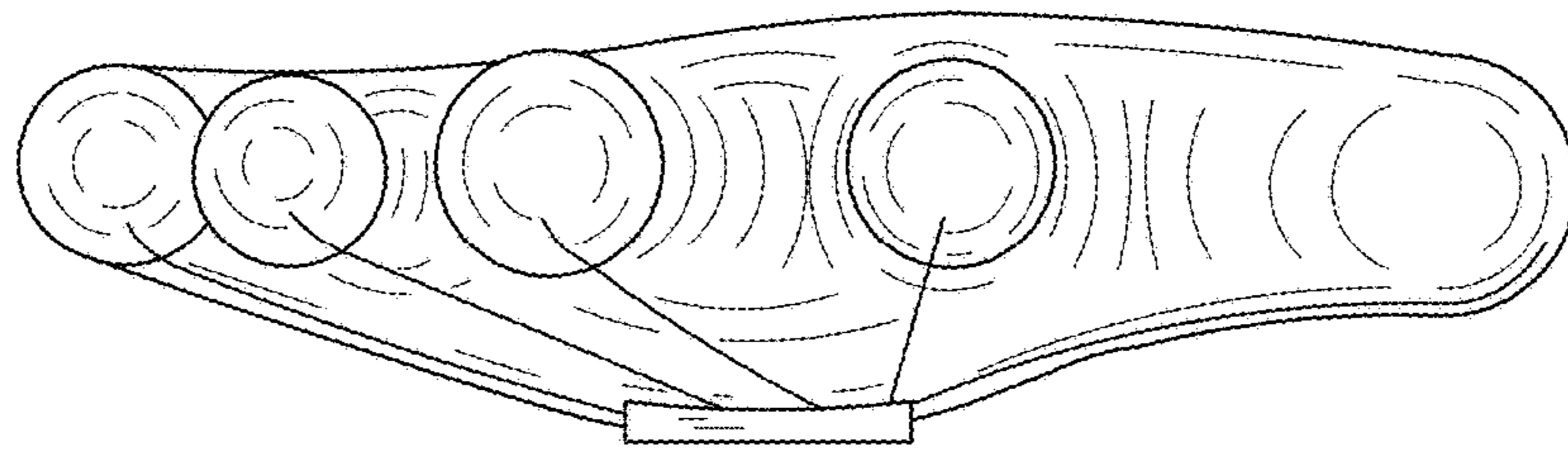

FIG. 5

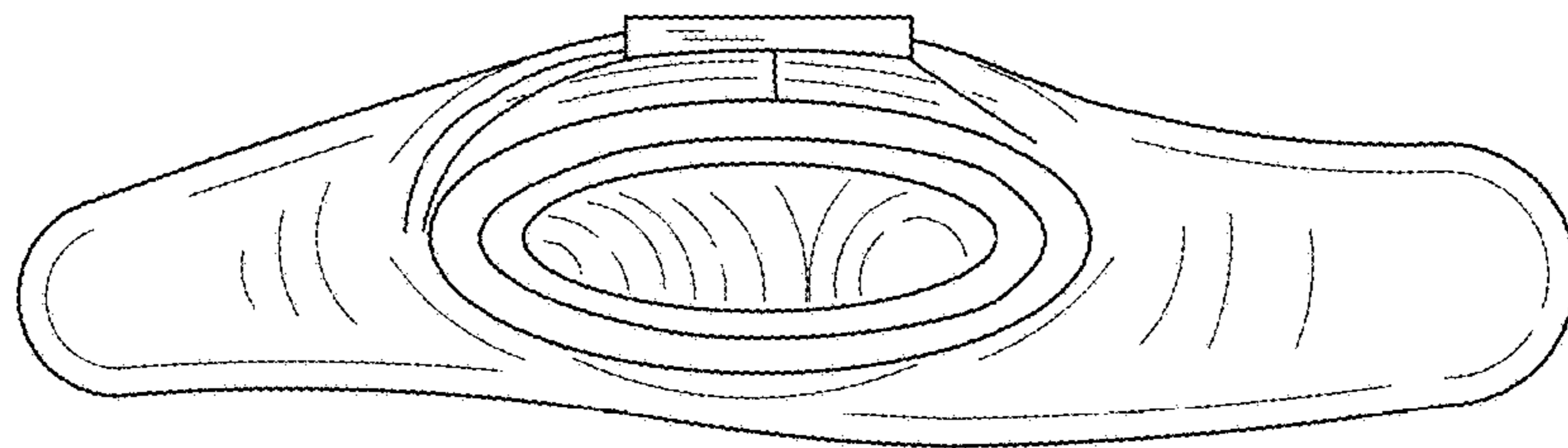

FIG. 6

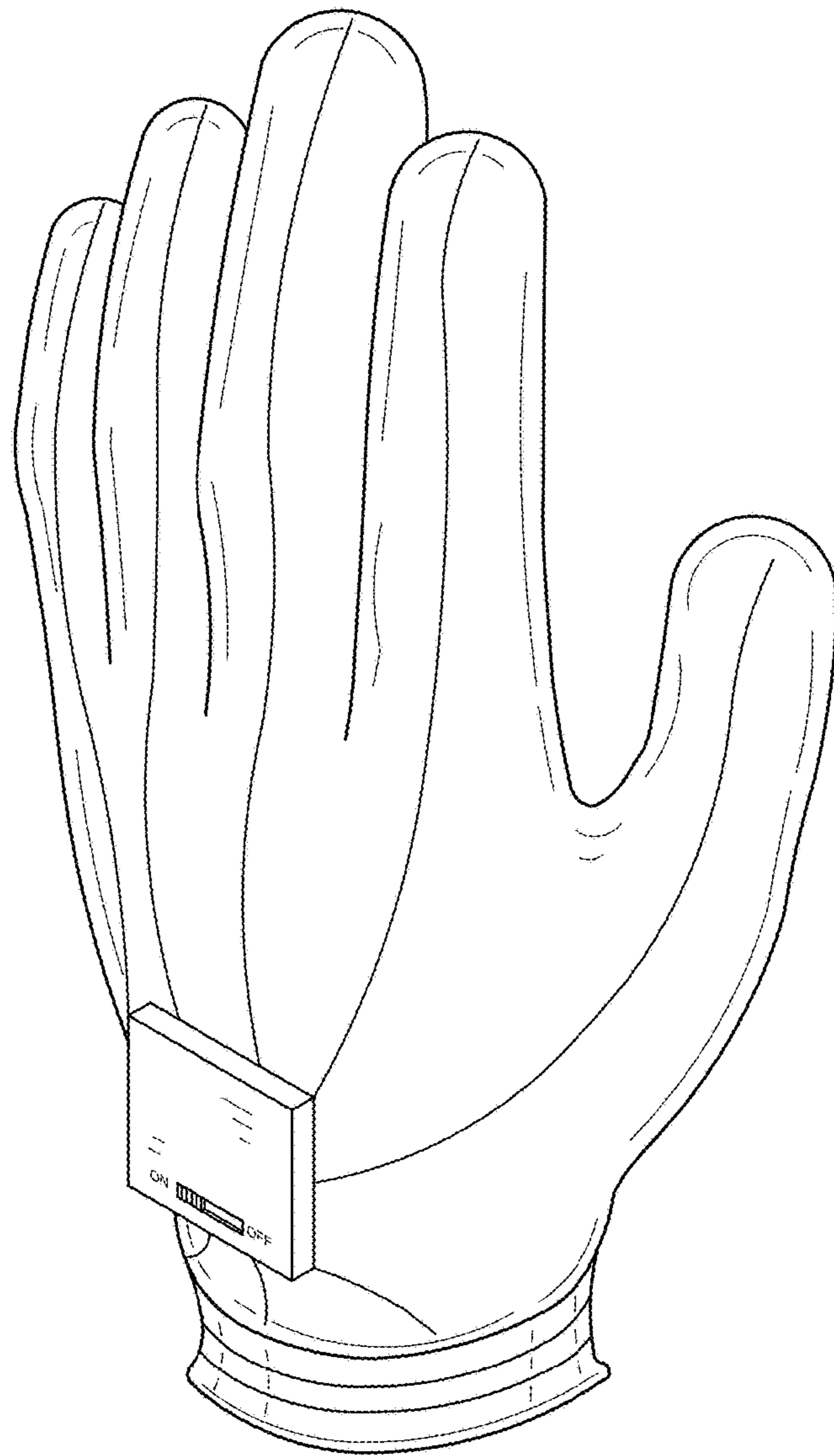

FIG. 7

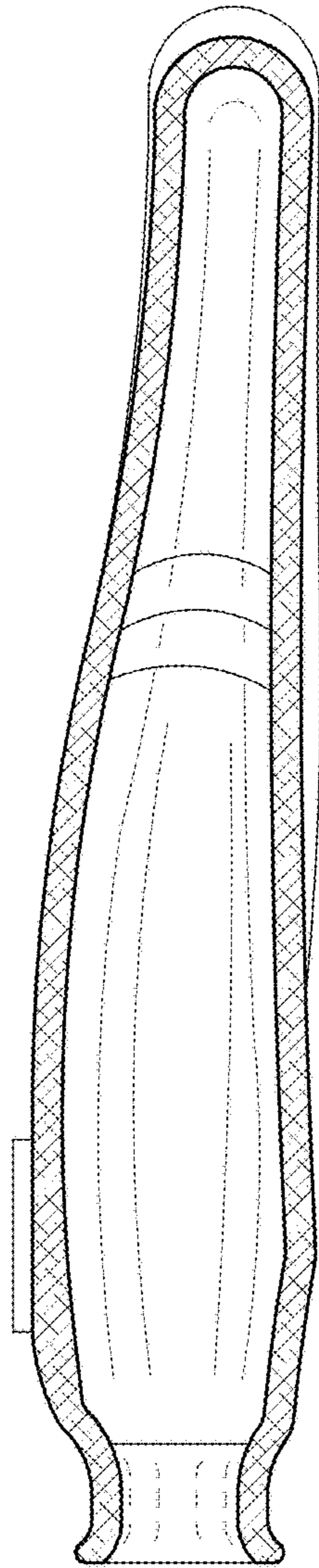

FIG. 8