



US00D849292S

(12) **United States Design Patent** (10) **Patent No.:** **US D849,292 S**
Ko (45) **Date of Patent:** **** May 21, 2019**

(54) **LAMP FOR VEHICLE**

(71) Applicants: **VISION X ASIA CO., LTD.**,
Hwaseong-si (KR); **In Hong Ko**, Seoul
(KR)

(72) Inventor: **In Hong Ko**, Seoul (KR)

(73) Assignees: **VISION X ASIA CO., LTD.**,
Hwaseong-Si (KR); **In Hong Ko**, Seoul
(KR)

(**) Term: **15 Years**

(21) Appl. No.: **29/649,033**

(22) Filed: **May 25, 2018**

(30) **Foreign Application Priority Data**

Nov. 28, 2017 (KR) 30-2017-0055973

(51) **LOC (11) Cl.** **26-07**

(52) **U.S. Cl.**
USPC **D26/36**

(58) **Field of Classification Search**
USPC D26/28, 29, 30, 31, 32, 33, 34, 35, 36;
362/459-468, 475-478, 485-487
CPC F21S 48/00; F21S 48/10; F21S 48/115;
F21S 48/225; F21S 48/1233; F21S
48/1266; F21S 48/1388; F21S 48/2268;
F21V 21/04
See application file for complete search history.

(56) **References Cited**

U.S. PATENT DOCUMENTS

D592,330 S * 5/2009 Huang D26/28
D601,727 S * 10/2009 Huang D26/28

D641,504 S * 7/2011 Lin D26/28
D642,309 S * 7/2011 Huang D26/28
D712,076 S * 8/2014 Haumann D26/28
D712,077 S * 8/2014 Leban D26/28
D713,594 S * 9/2014 Norris D26/118
D766,473 S * 9/2016 Riedel D26/28
D793,589 S * 8/2017 Deyaf D26/28
D794,844 S * 8/2017 Leban D26/28
D805,225 S * 12/2017 Dennis D26/28
D822,238 S * 7/2018 Deering D26/28
D827,883 S * 9/2018 Deyaf D26/28

* cited by examiner

Primary Examiner — Angela J Lee

(74) *Attorney, Agent, or Firm* — Cantor Colburn LLP

(57) **CLAIM**

The ornamental design for a lamp for vehicle, as shown and described.

DESCRIPTION

FIG. 1 is a perspective view of a lamp for vehicle showing my new design;
FIG. 2 is a front elevational view thereof;
FIG. 3 is a rear elevational view thereof;
FIG. 4 is a left side elevational view thereof;
FIG. 5 is a right side elevational view thereof;
FIG. 6 is a top plan view thereof; and,
FIG. 7 is a bottom plan view thereof.
The broken lines are included for illustrative purposes only and form no part of the claimed design.

1 Claim, 6 Drawing Sheets

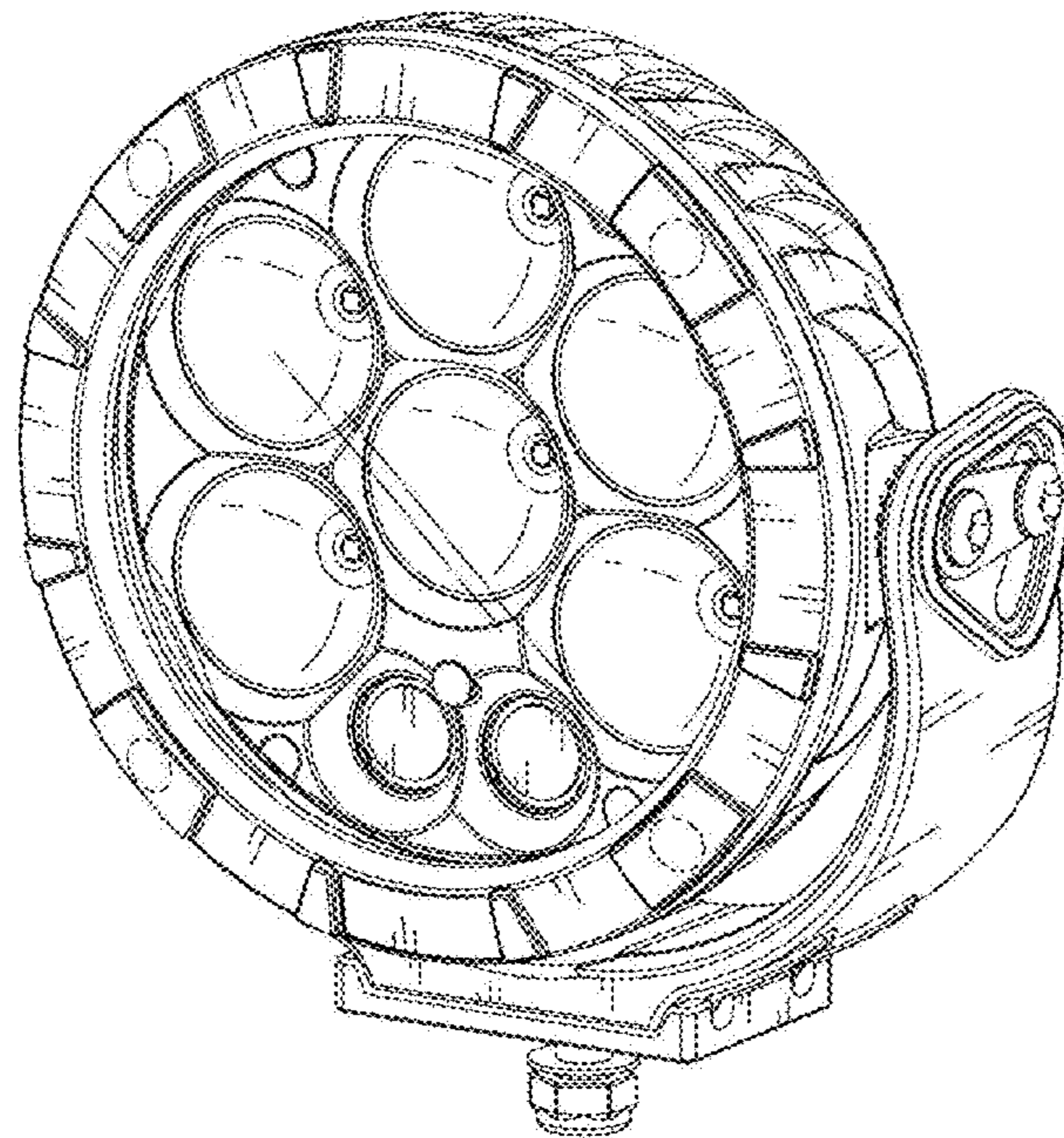

FIG. 1

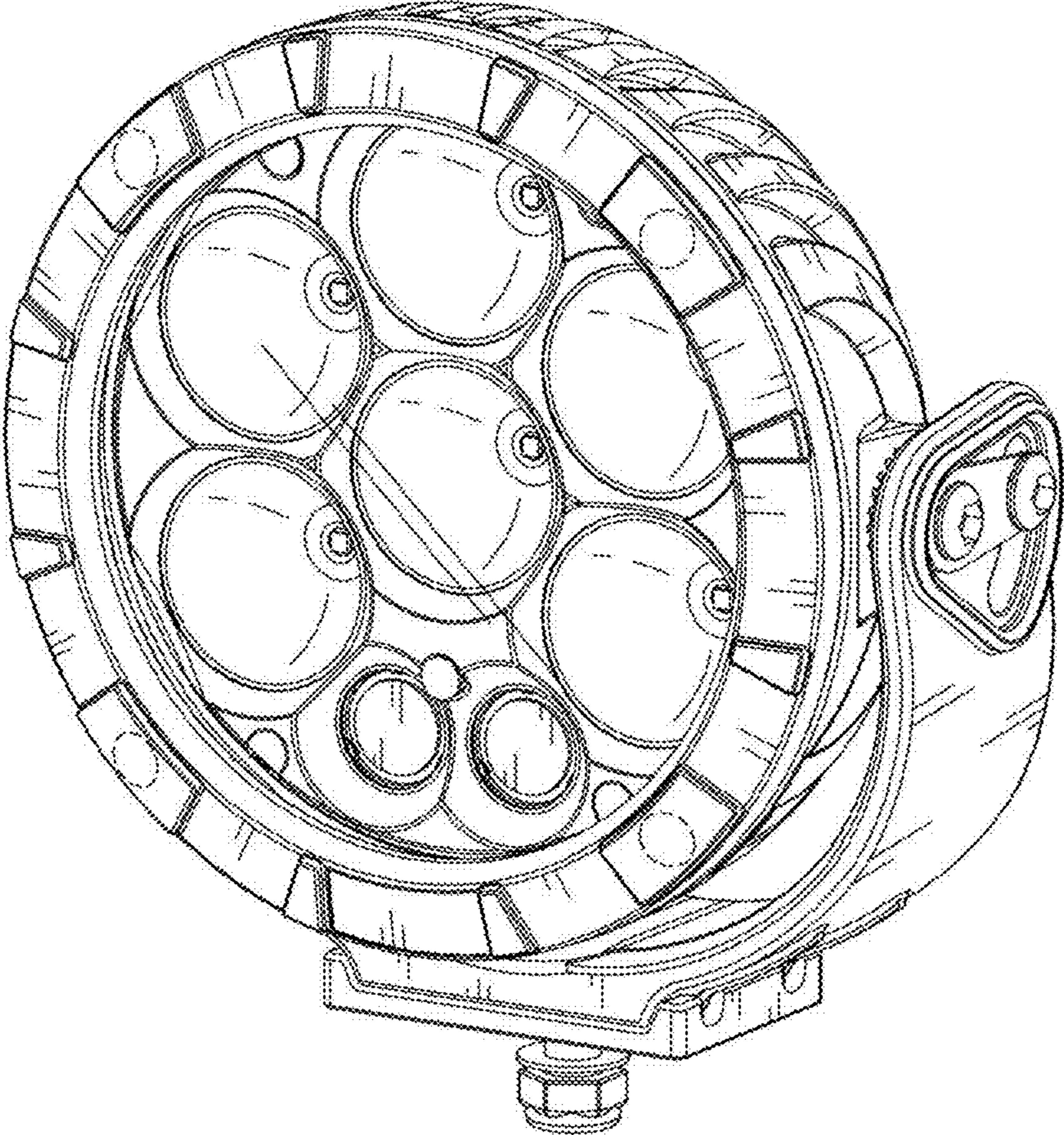

FIG. 2

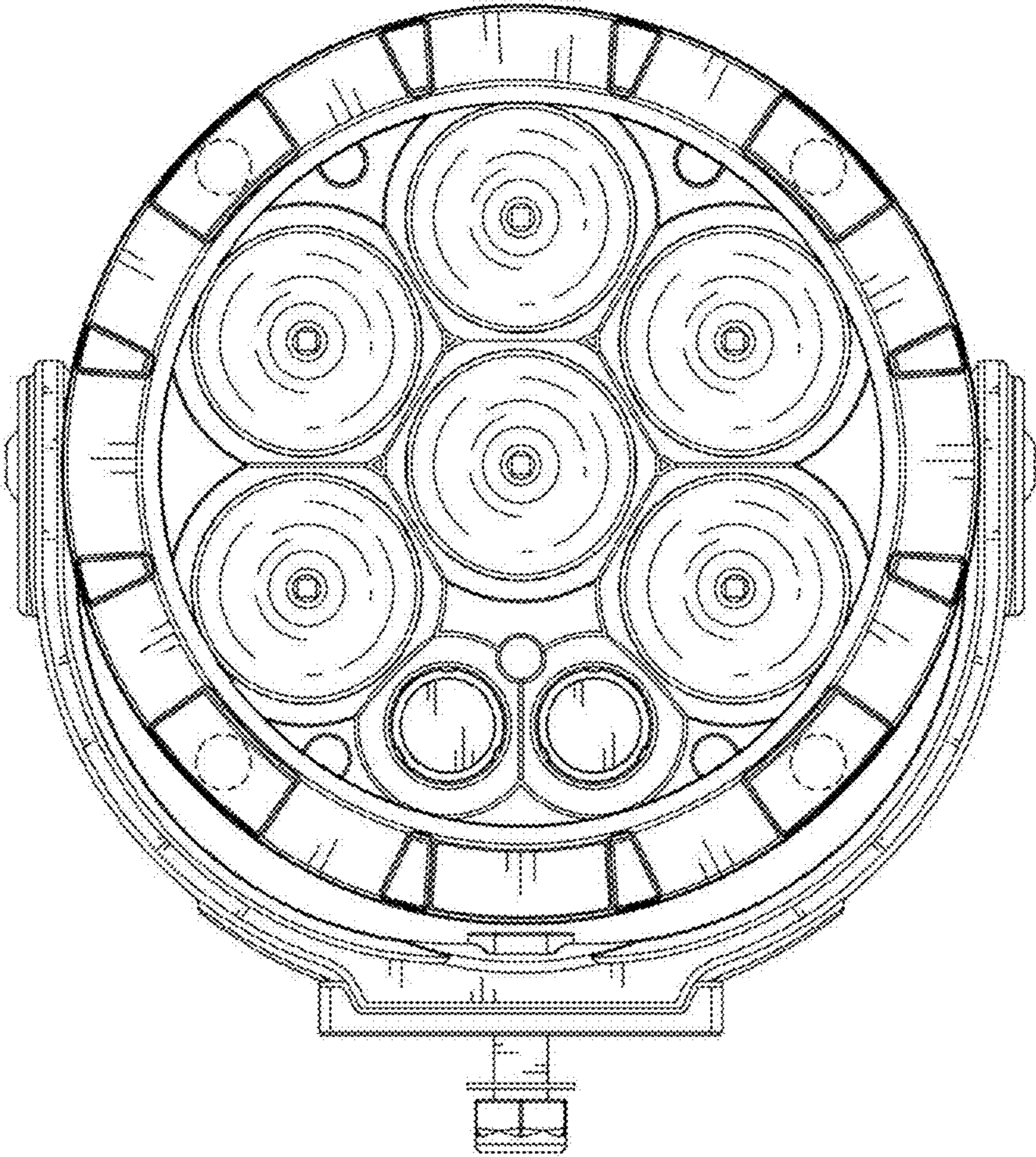

FIG. 3

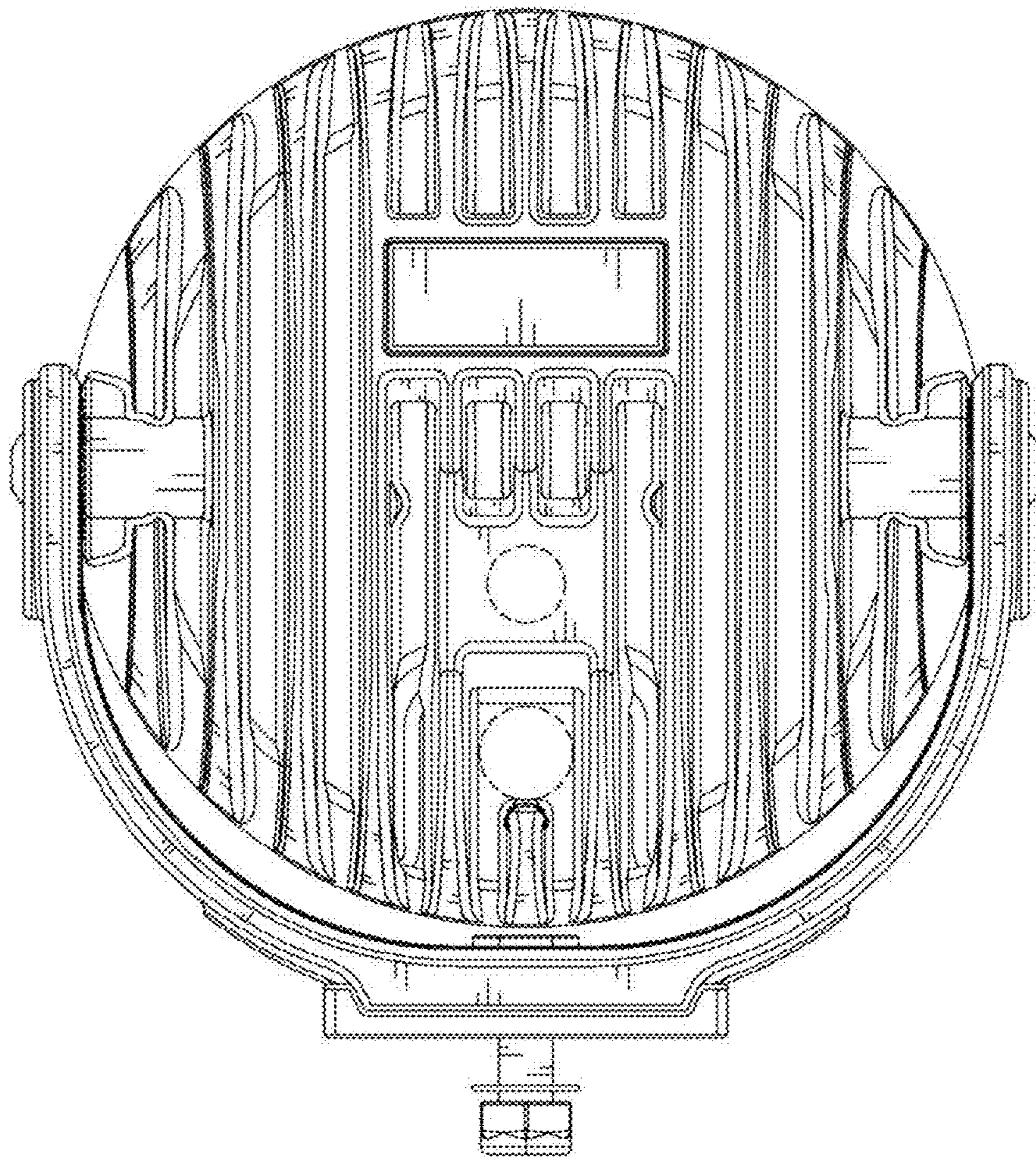

FIG. 4

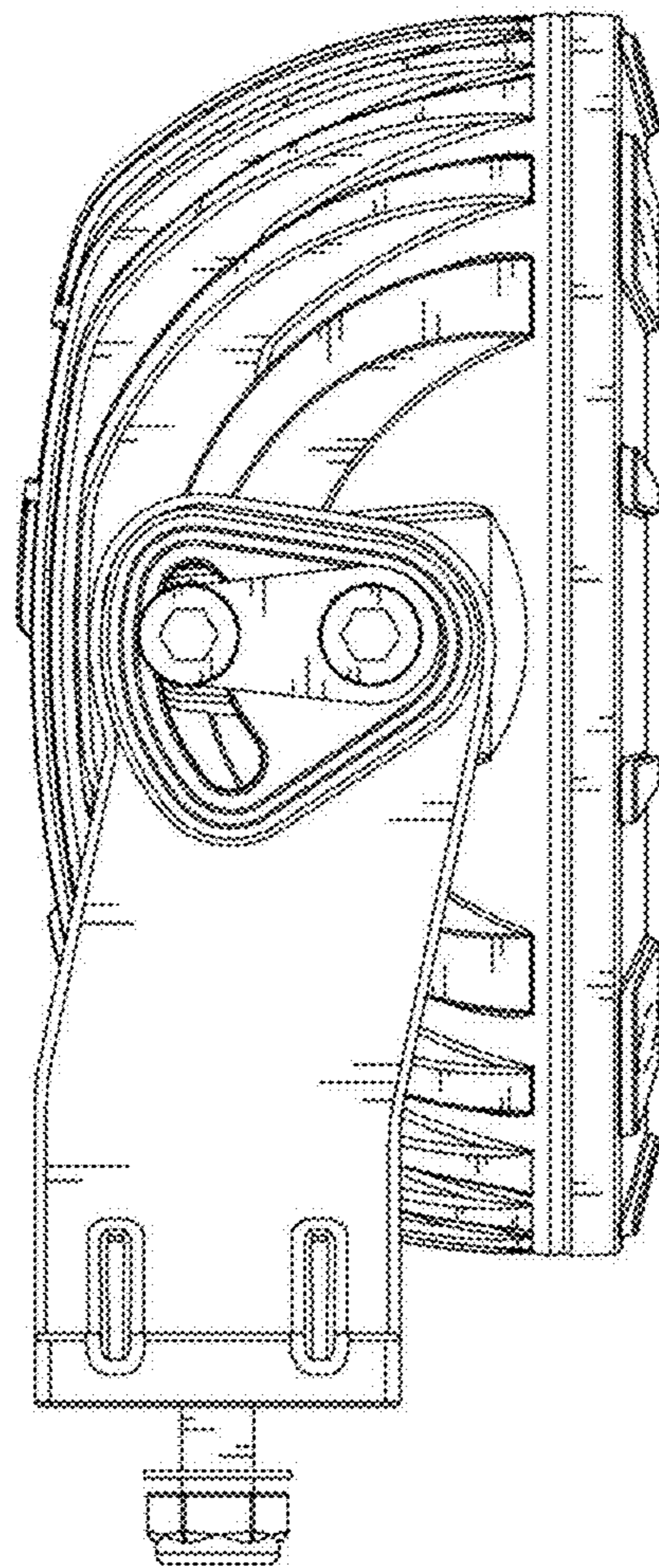

FIG. 5

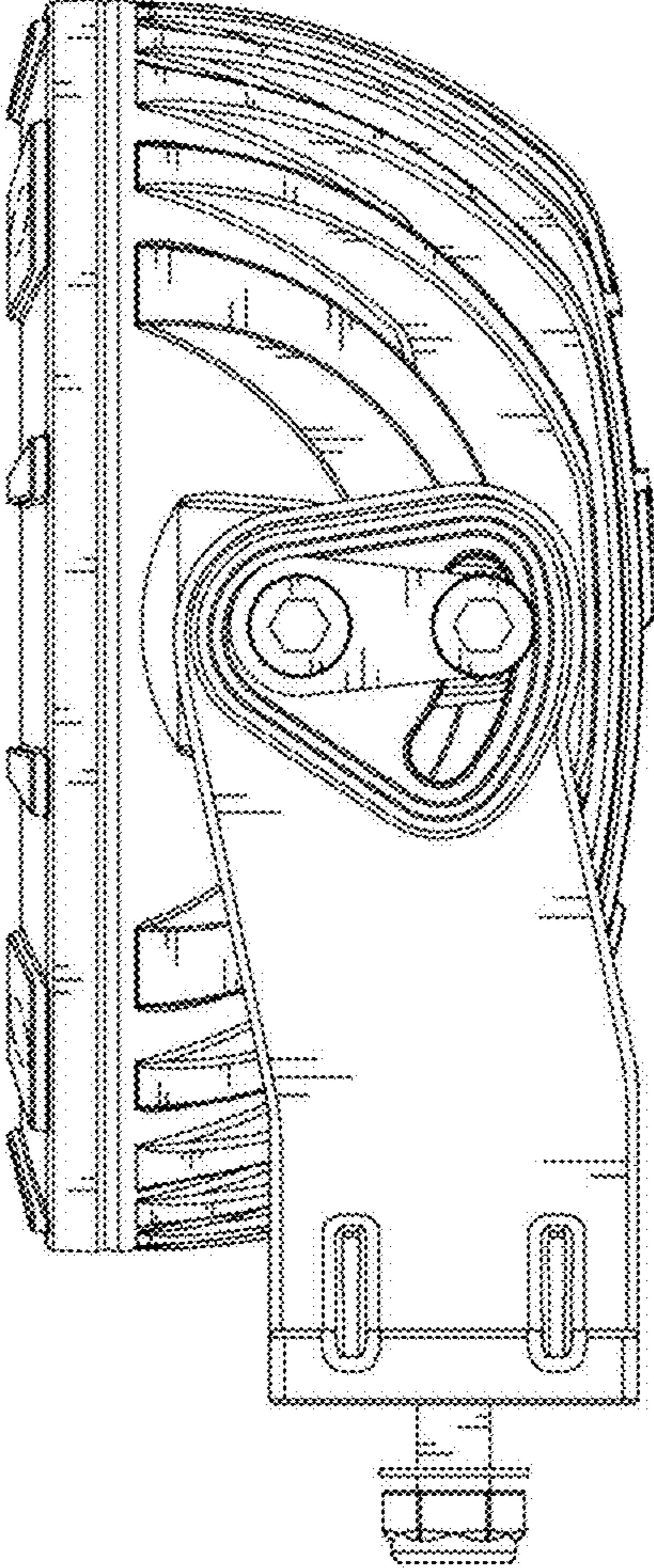

FIG. 6

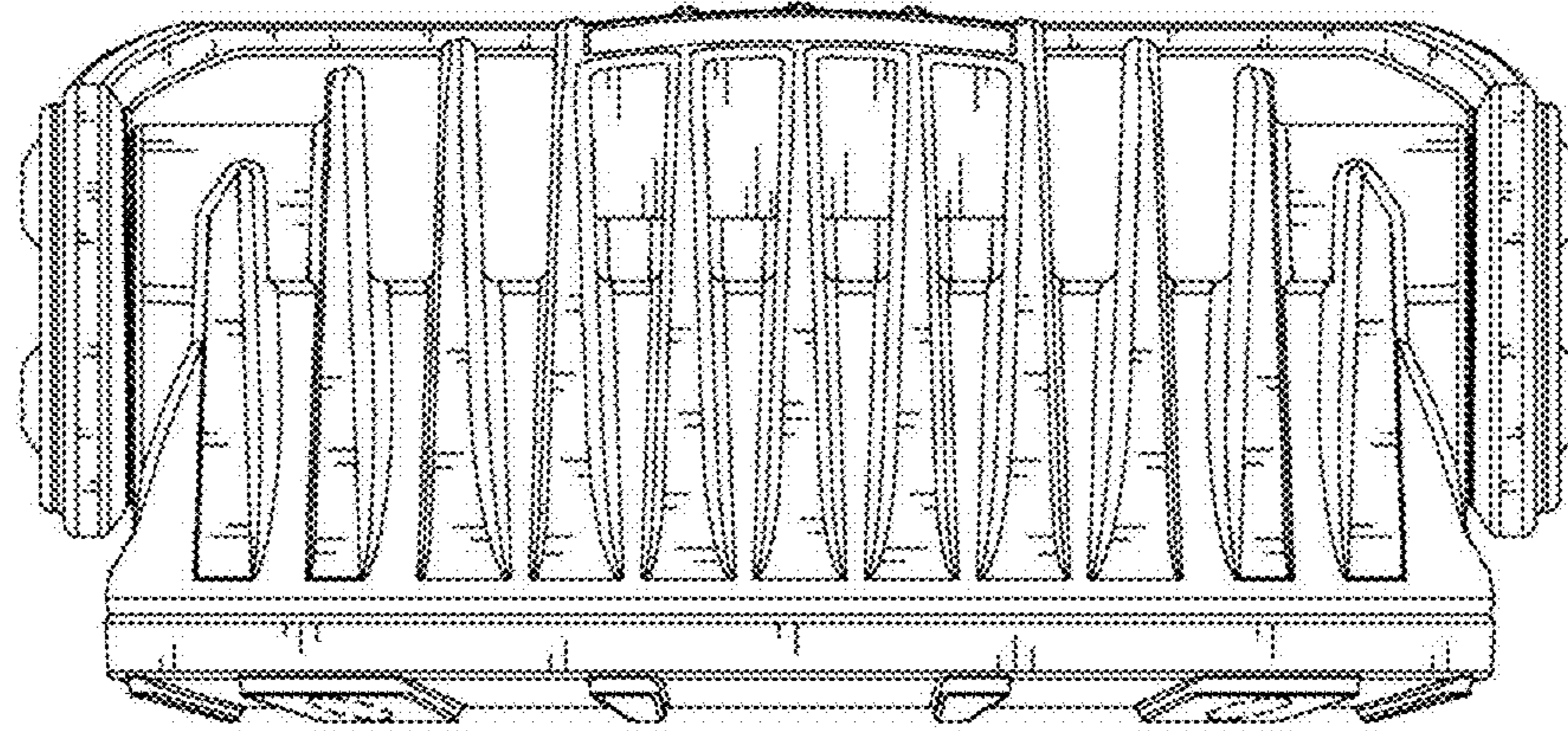

FIG. 7

