



US00D849214S

(12) **United States Design Patent**
Elsinger

(10) **Patent No.:** **US D849,214 S**

(45) **Date of Patent:** **** May 21, 2019**

- (54) **SINK**
- (71) Applicant: **BLANCO GmbH + Co KG**,
Oberderdingen (DE)
- (72) Inventor: **Bernd Elsinger**, Sulzfeld (DE)
- (73) Assignee: **BLANCO GmbH + Co KG**,
Oberderdingen (DE)
- (**) Term: **15 Years**
- (21) Appl. No.: **29/638,072**
- (22) Filed: **Feb. 23, 2018**
- (51) **LOC (11) Cl.** **23-02**
- (52) **U.S. Cl.**
USPC **D23/293.1**
- (58) **Field of Classification Search**
USPC ... D23/270, 284, 285, 290, 289, 293.1, 303,
D23/308, 499; D6/524, 573, 663-666,
D6/671; D7/550.1, 554.3, 553.2
CPC ... E03C 1/12; E03C 1/18; E03C 1/181; A47K
1/04; A47B 77/06; A47J 47/20
See application file for complete search history.

- D408,682 S * 4/1999 Costa D7/354
- D538,409 S * 3/2007 Gross D23/293.1
- D596,902 S * 7/2009 Hrovat D7/550.1
- D687,679 S * 8/2013 Mikulka D7/553.2
- D796,651 S * 9/2017 Ziemann D23/293.1

* cited by examiner

Primary Examiner — Sheryl Lane

Assistant Examiner — Samantha N Wood

(74) *Attorney, Agent, or Firm* — Hanley, Flight &
Zimmerman, LLC.

(56) **References Cited**
U.S. PATENT DOCUMENTS

- D147,748 S * 10/1947 Harder D23/290
- D262,104 S * 12/1981 Simpson D13/119

(57) **CLAIM**

The ornamental design for a “sink,” as shown and described.

DESCRIPTION

FIG. 1 is a perspective view of a sink.
 FIG. 2 is a top plan view of the sink of FIG. 1.
 FIG. 3 is a bottom view of the sink of FIG. 1.
 FIG. 4 is a front view of the sink of FIG. 1.
 FIG. 5 is a rear view of the sink of FIG. 1.
 FIG. 6 is a right side view of the sink of FIG. 1; and,
 FIG. 7 is a left side view of the sink of FIG. 1.

1 Claim, 7 Drawing Sheets

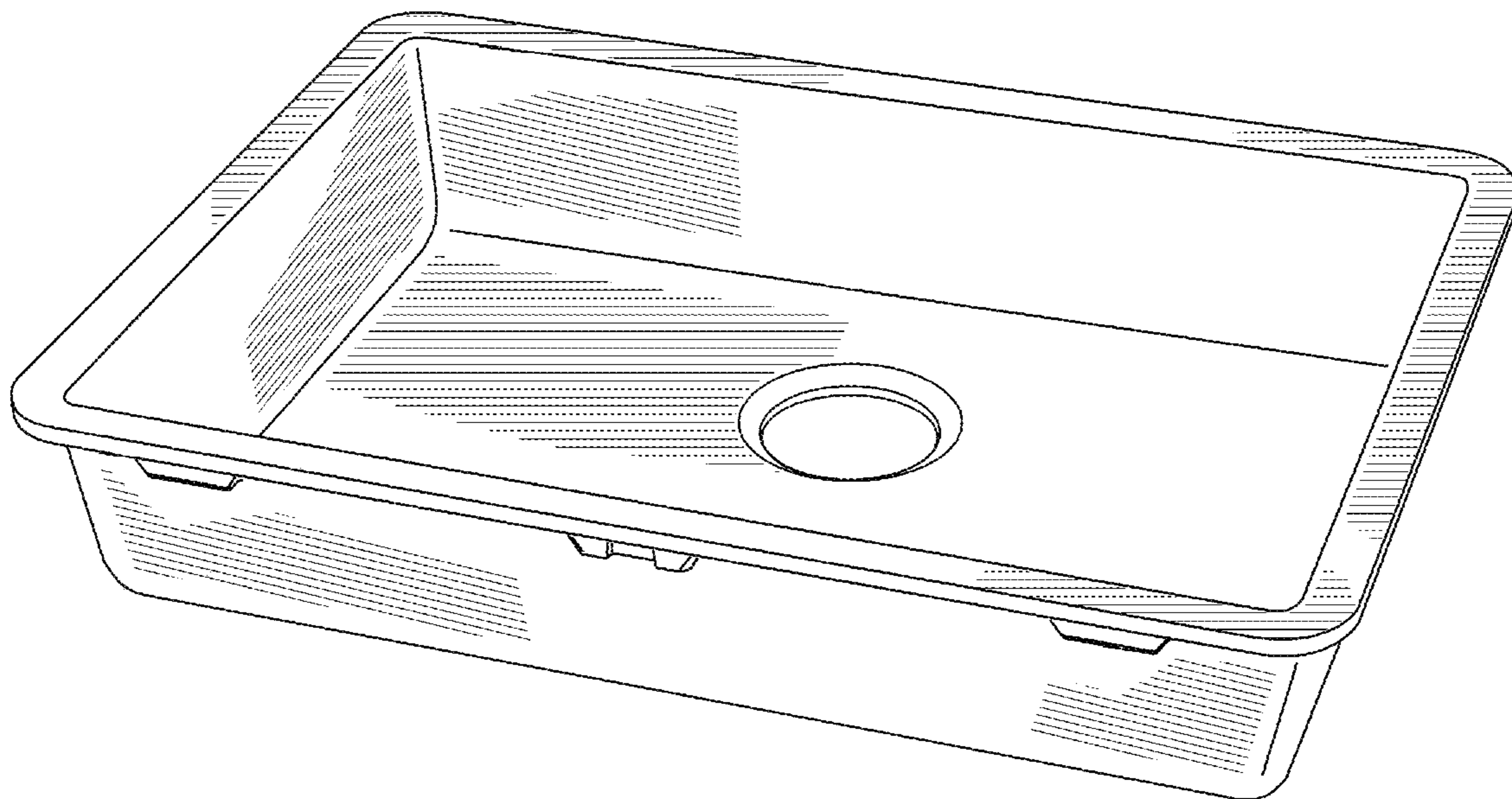

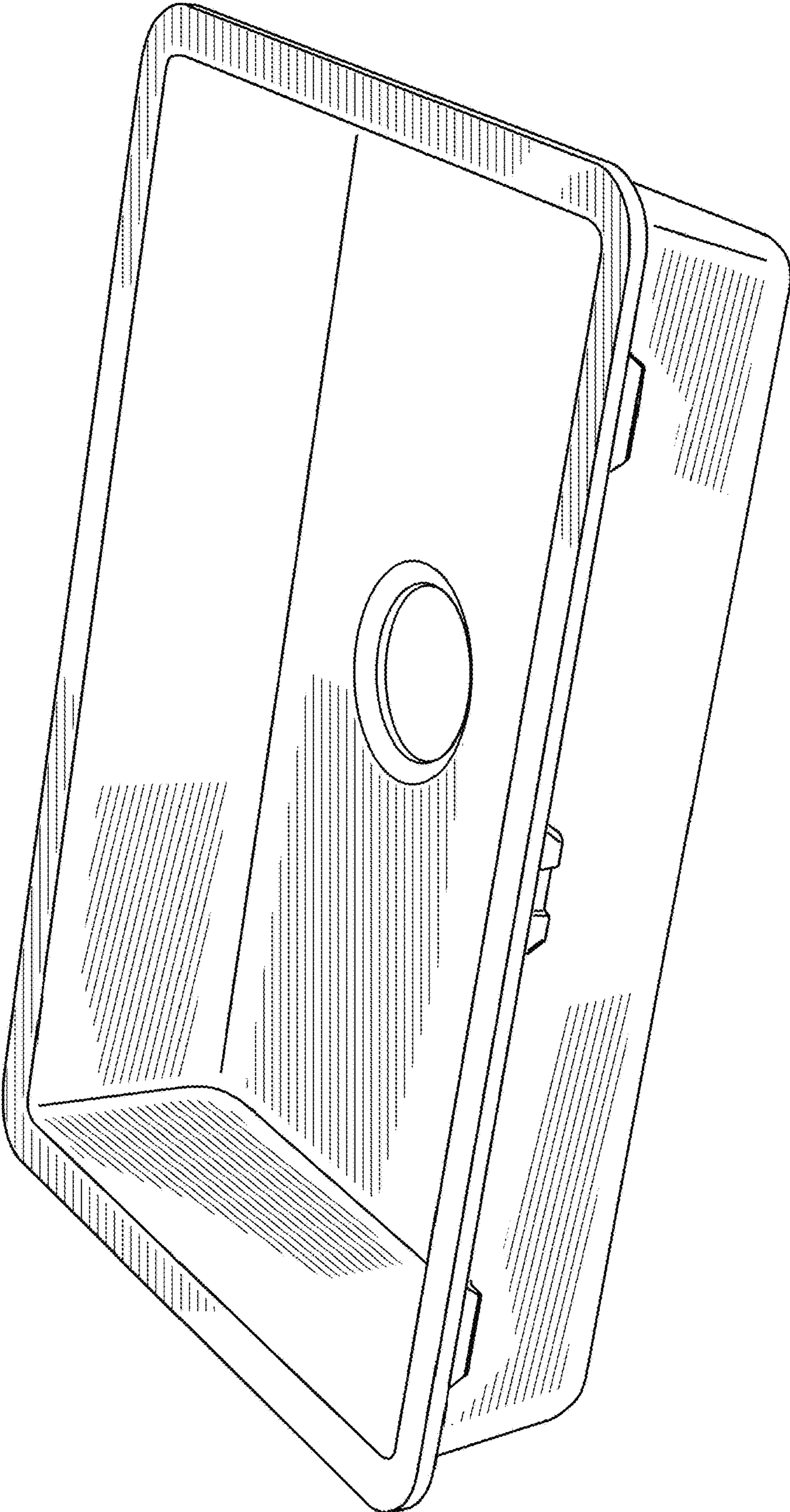

FIG. 1

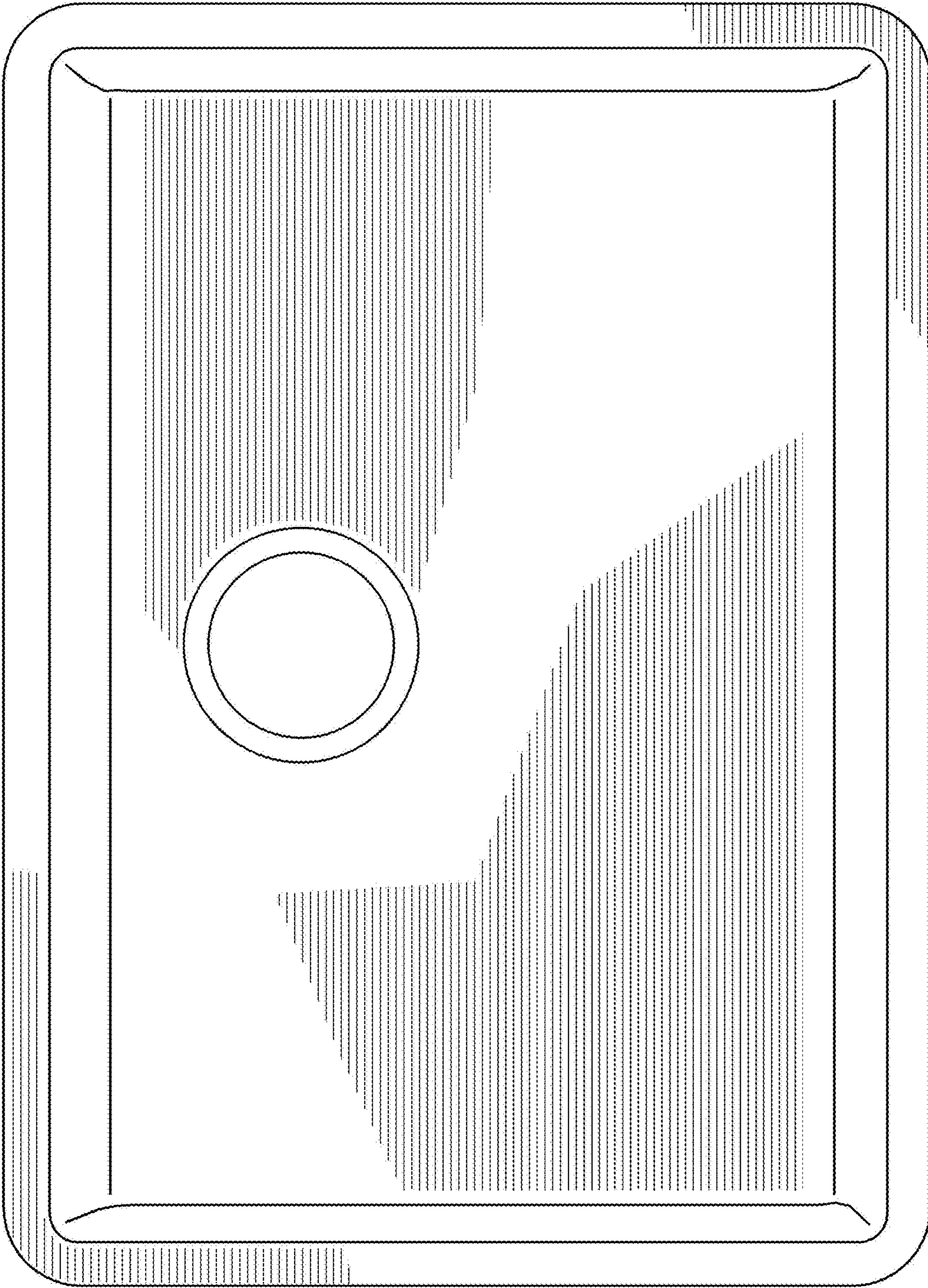

FIG. 2

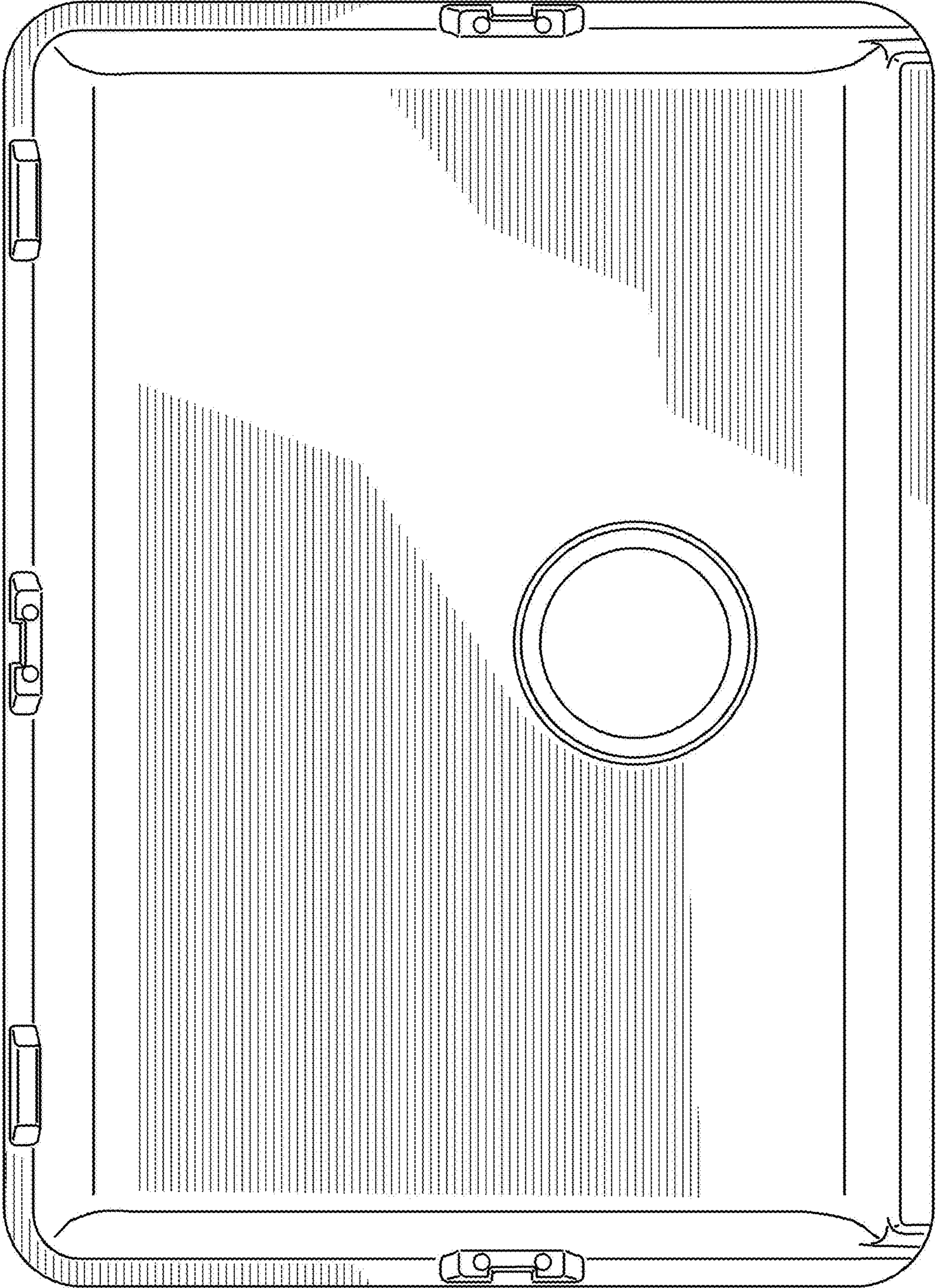

FIG. 3

FIG. 4

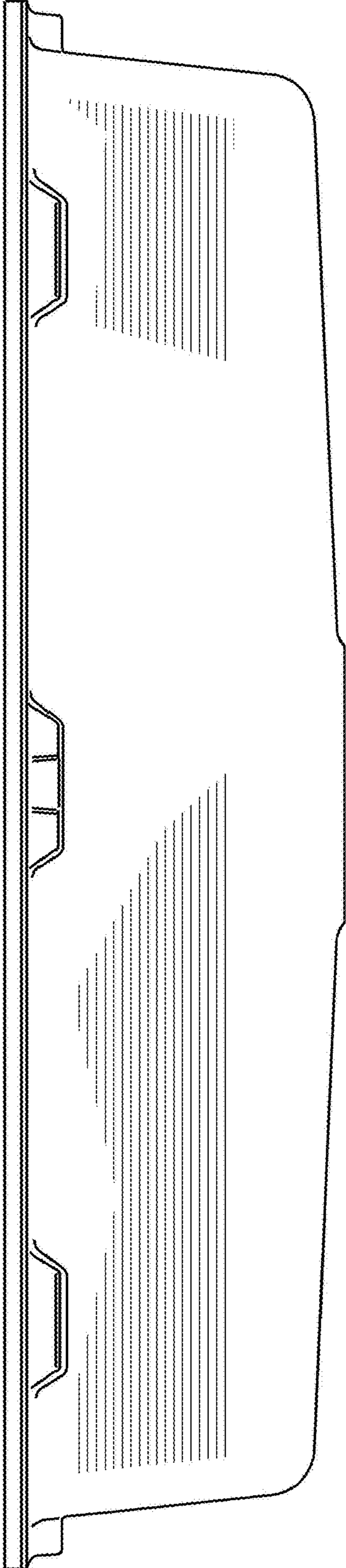

FIG. 5

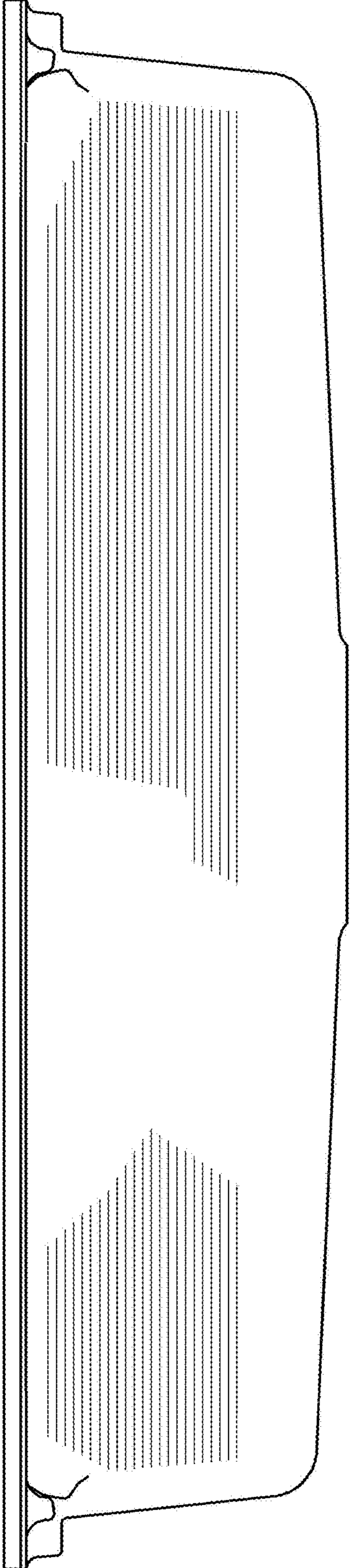

FIG. 6

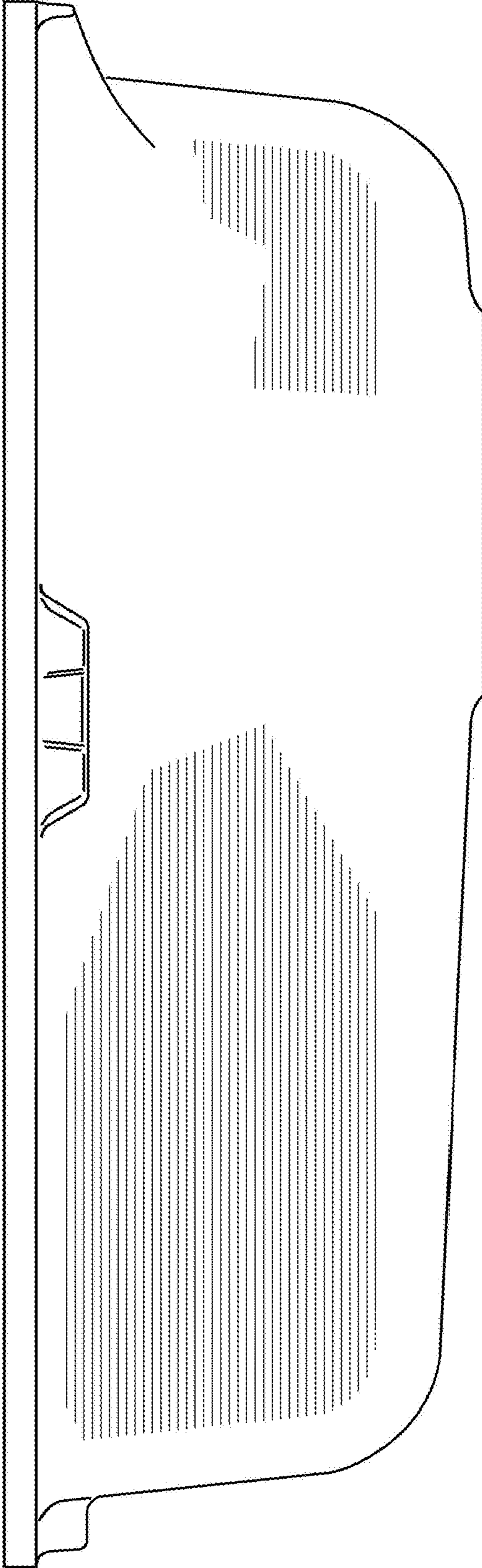

FIG. 7

