



US00D849202S

(12) **United States Design Patent**
Zhang

(10) **Patent No.:** **US D849,202 S**

(45) **Date of Patent:** **** May 21, 2019**

(54) **FAUCET**

(71) Applicant: **Xinrui Zhang**, Kaiping (CN)

(72) Inventor: **Xinrui Zhang**, Kaiping (CN)

(**) Term: **15 Years**

(21) Appl. No.: **29/671,101**

(22) Filed: **Nov. 22, 2018**

(51) **LOC (11) Cl.** **23-01**

(52) **U.S. Cl.**
USPC **D23/238**

(58) **Field of Classification Search**
USPC D23/238-243, 249-250, 252, 254-255,
D23/257, 213, 223, 226, 229; D8/300,
D8/307-308
CPC ... Y10T 137/9464; E03C 1/04; E03C 1/0401;
E03C 1/0402; E03C 1/0404; E03C
1/0405; E03C 1/0412; E03C 1/0413;
E03C 1/0409; E03C 1/042
See application file for complete search history.

(56) **References Cited**

U.S. PATENT DOCUMENTS

D290,740 S * 7/1987 Yost D23/252
D645,122 S * 9/2011 Fritz D23/238

D705,398 S * 5/2014 Flowers D23/238
D786,405 S * 5/2017 Schaubach D23/238
2004/0112985 A1* 6/2004 Malek E03C 1/04
239/445

* cited by examiner

Primary Examiner — Robert A Delehanty
(74) *Attorney, Agent, or Firm* — Wayne V. Harper

(57) **CLAIM**

I claim the ornamental design for a faucet, as shown and described.

DESCRIPTION

FIG. 1 is a perspective view of a faucet showing my new design;
FIG. 2 is back perspective view of the faucet as shown in FIG. 1;
FIG. 3 is a left-side view of the faucet as shown in FIG. 1;
FIG. 4 is a right-side view of the faucet as shown in FIG. 1;
FIG. 5 is a front-side view of the faucet as shown in FIG. 1;
FIG. 6 is a back-side view of the faucet as shown in FIG. 1;
FIG. 7 is a top-side view of the faucet as shown in FIG. 1;
and,
FIG. 8 is a bottom-side view of the faucet as shown in FIG. 1.
The broken lines are only for environmental purposes and form no part of the claimed design. No particular colour scheme forms part of the claimed design.

1 Claim, 7 Drawing Sheets

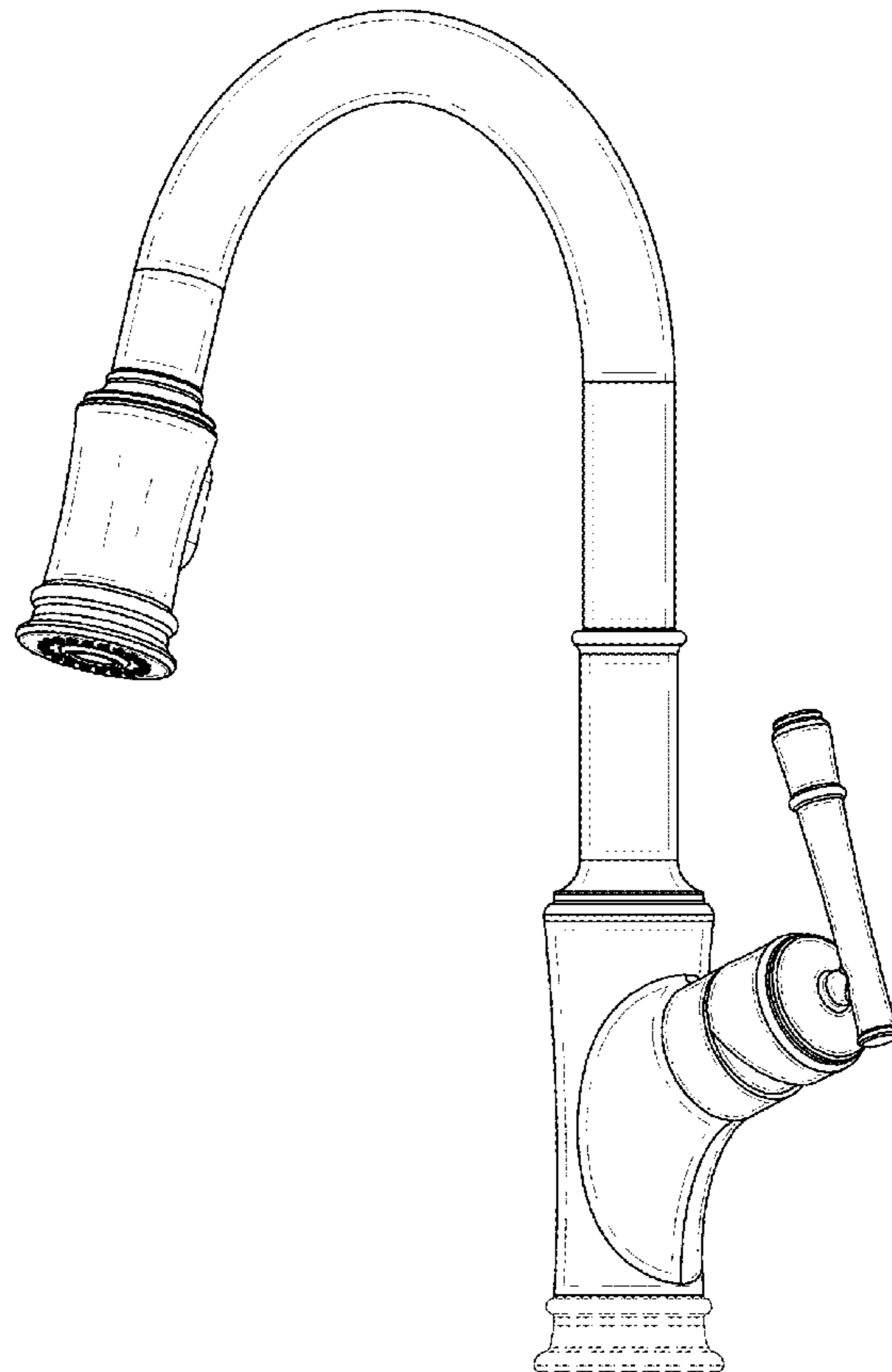

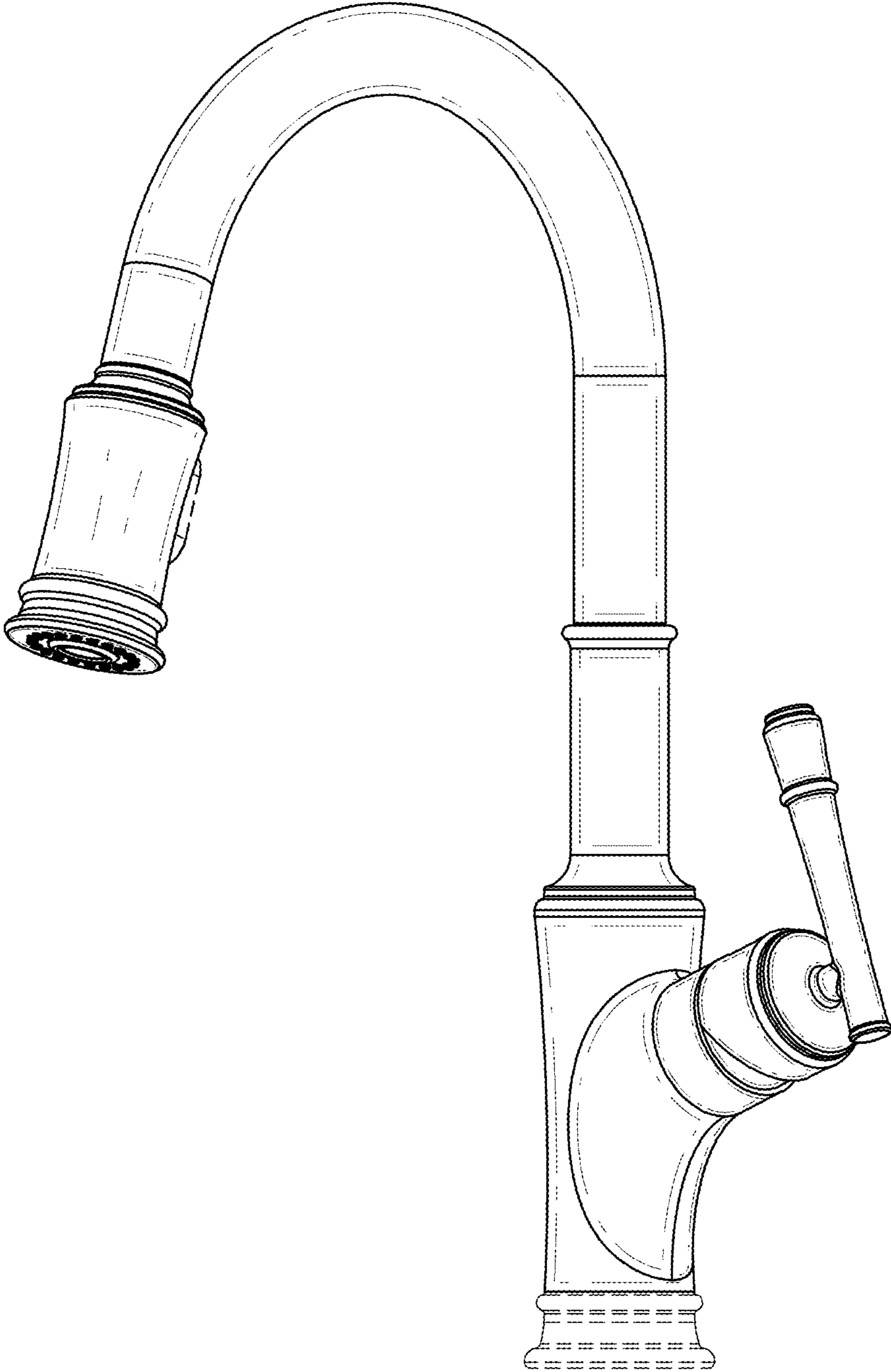

FIG. 1

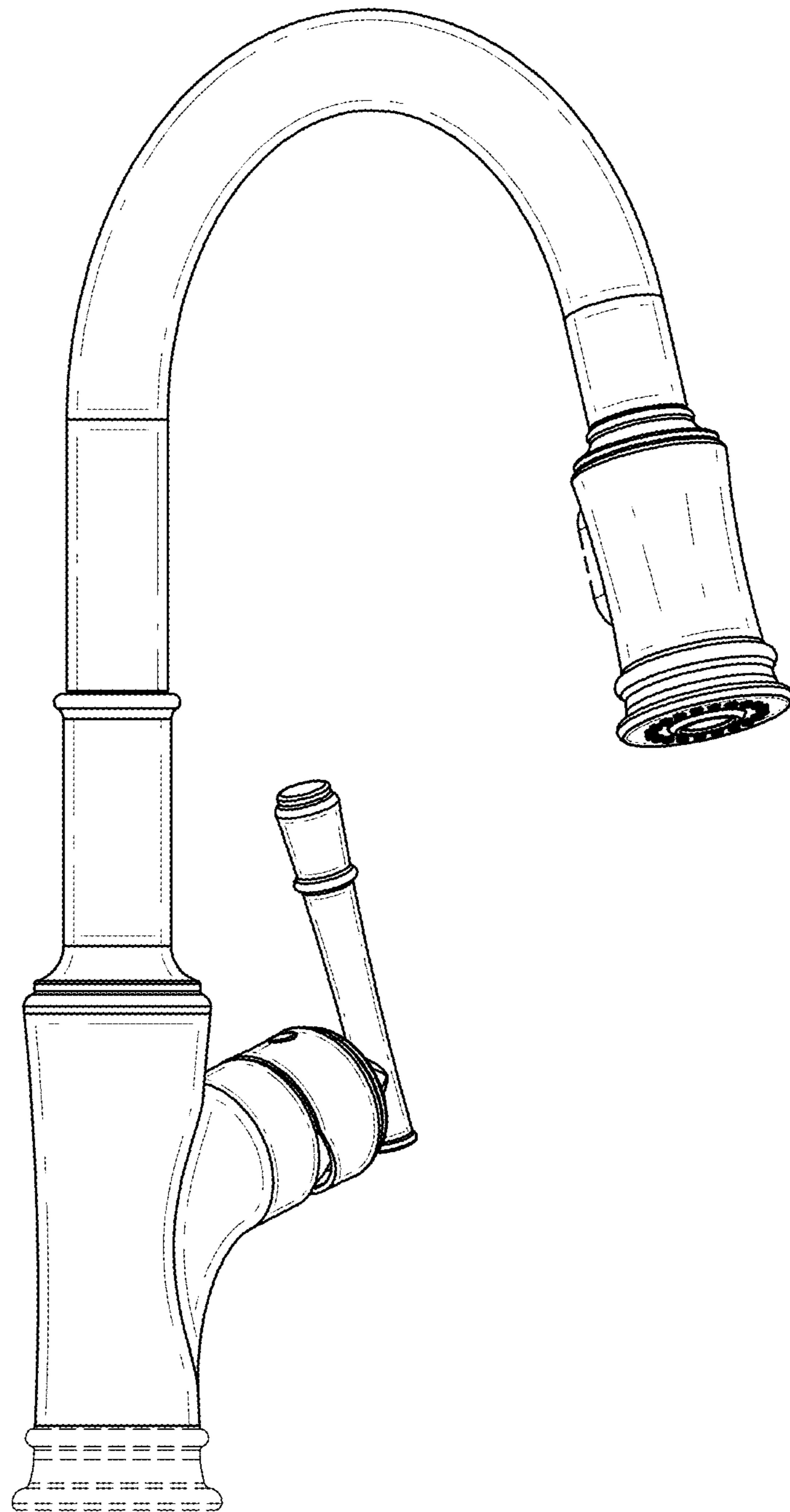

FIG. 2

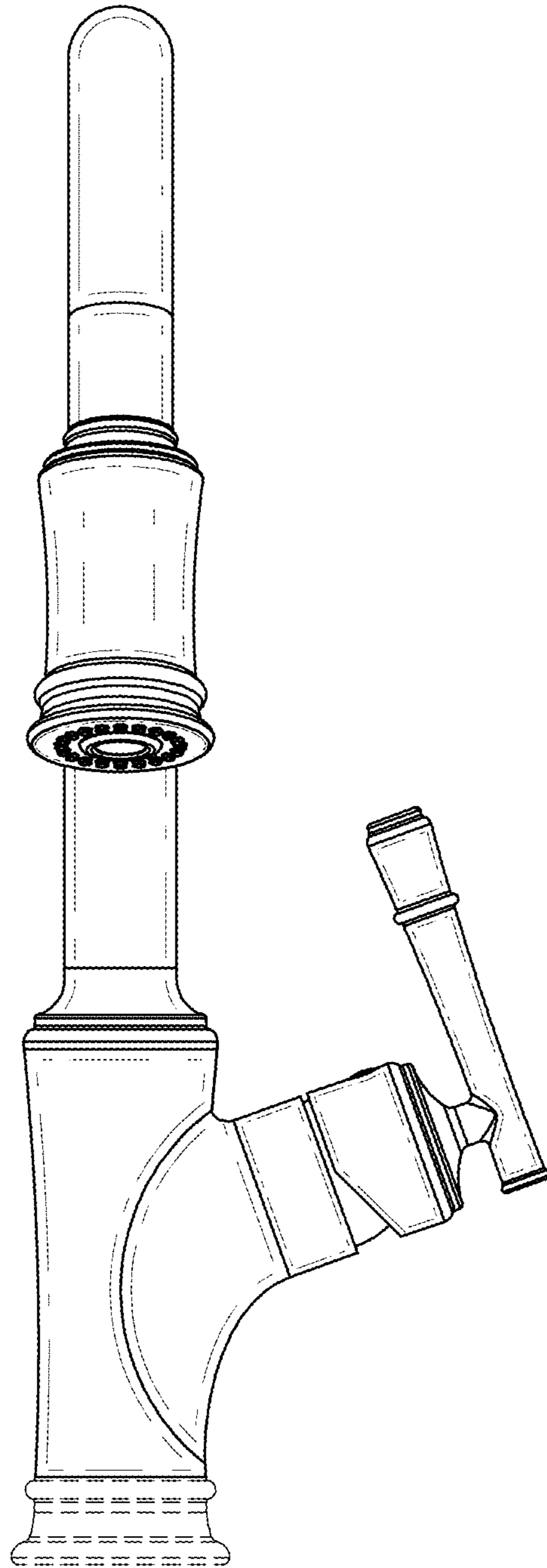

FIG. 3

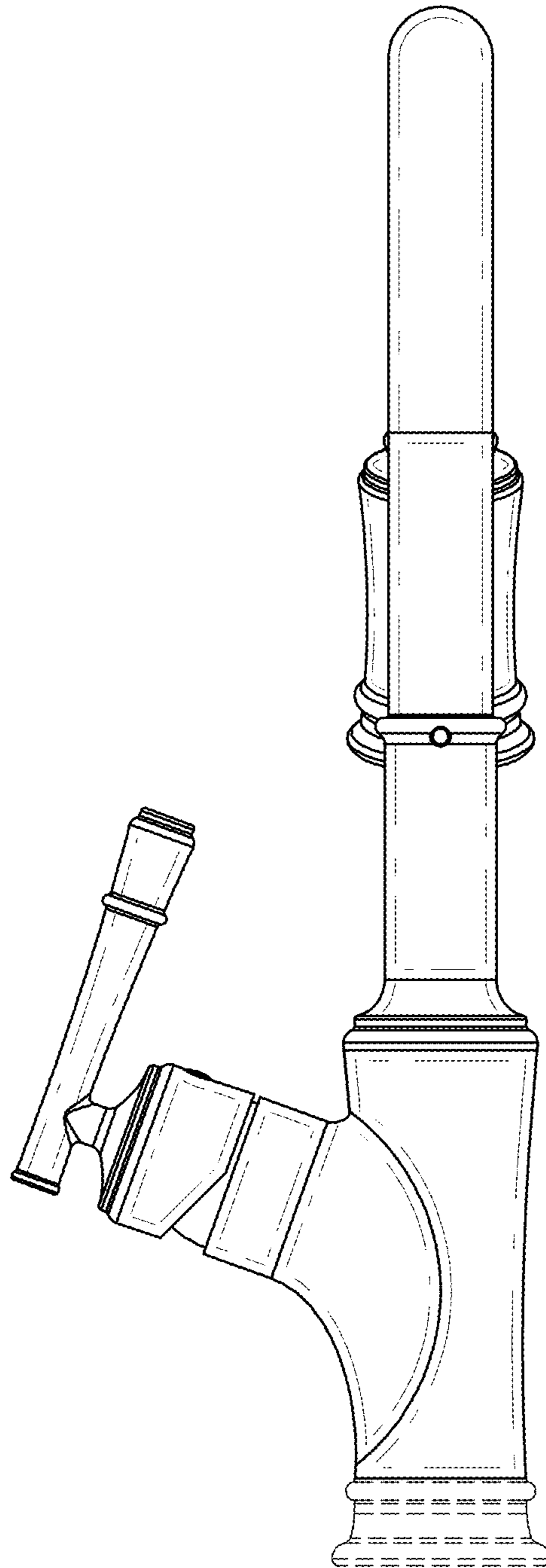

FIG. 4

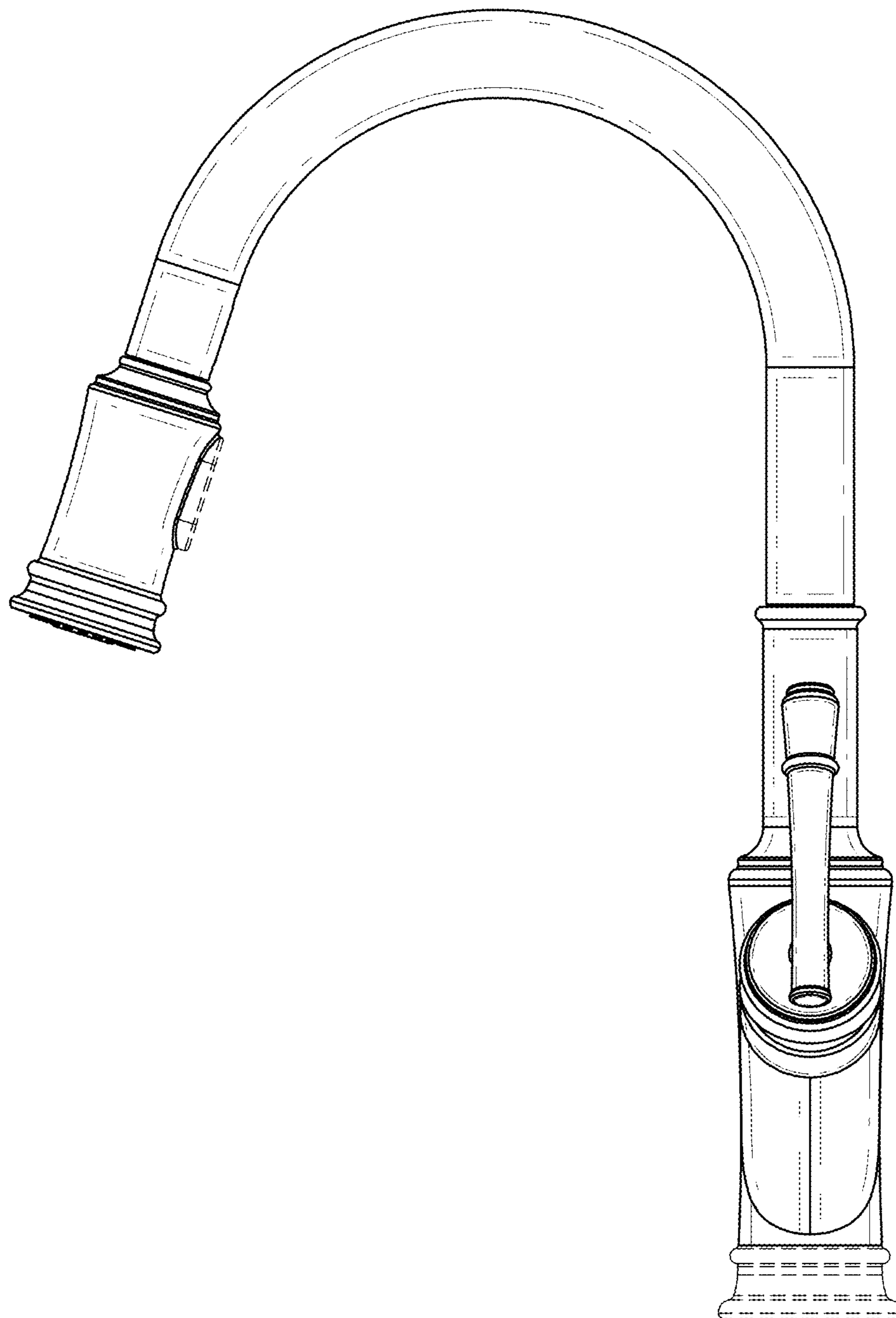

FIG. 5

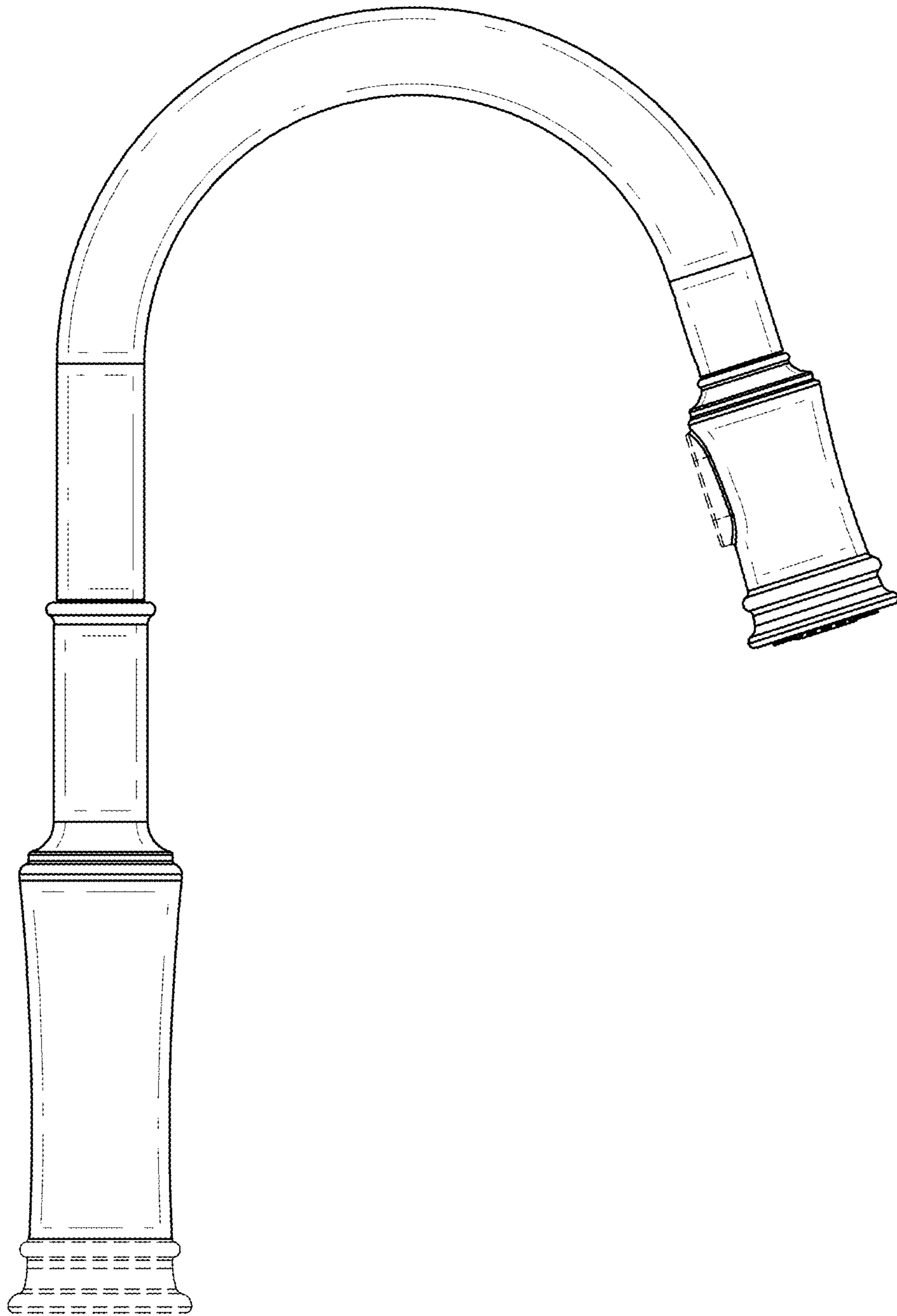

FIG. 6

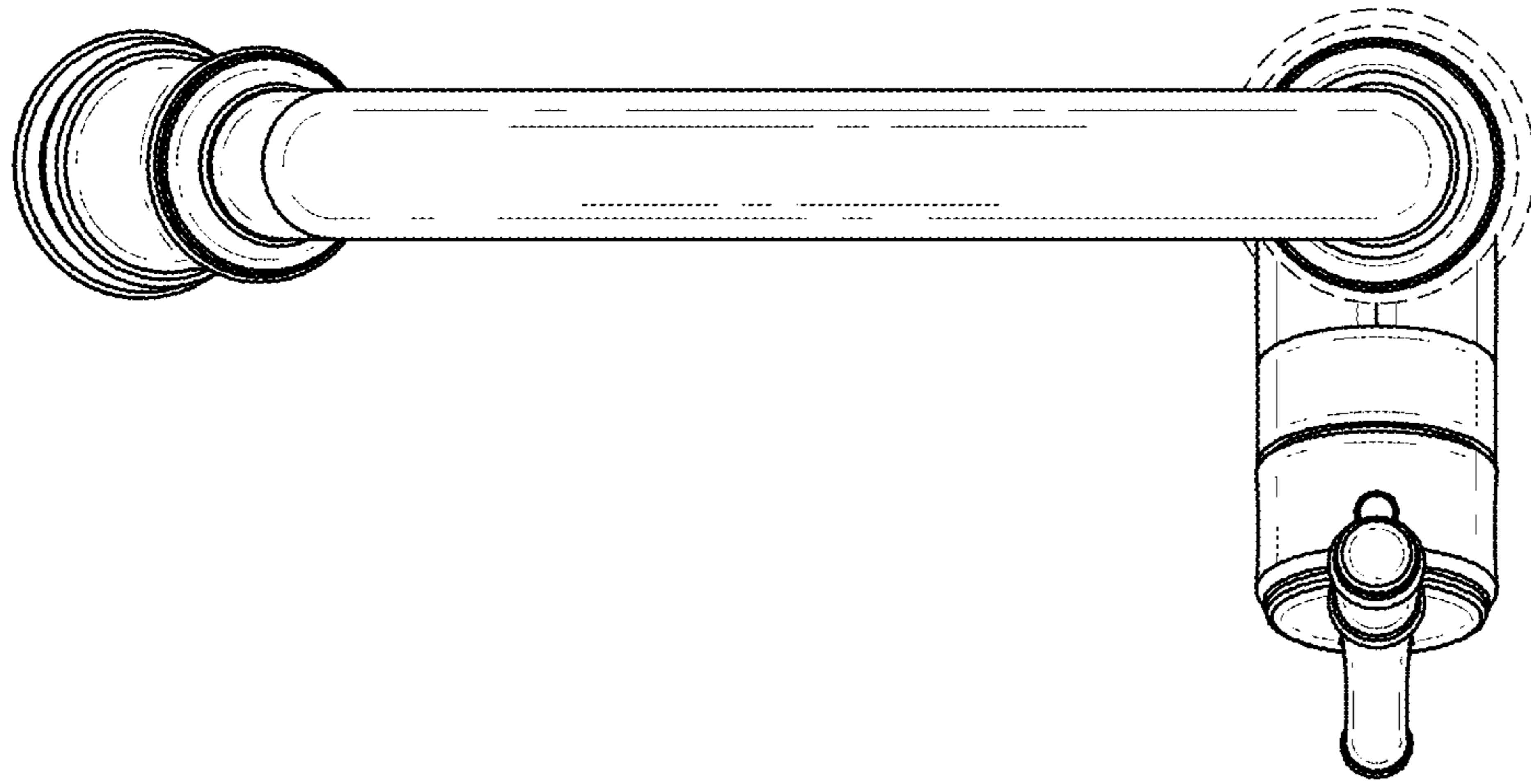

FIG. 7

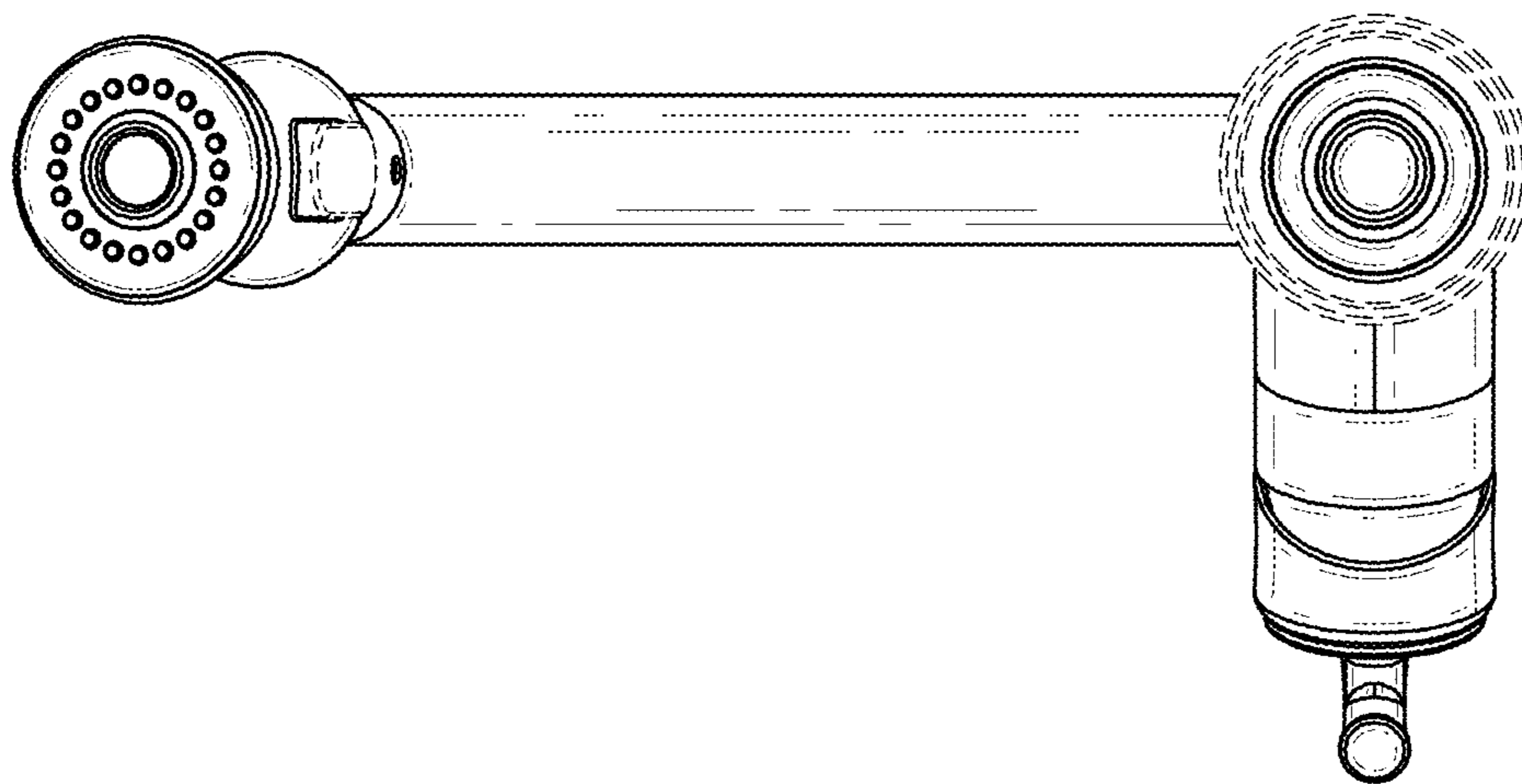

FIG. 8