



US00D849150S

(12) **United States Design Patent**  
**Gallagher et al.**

(10) **Patent No.:** **US D849,150 S**

(45) **Date of Patent:** **\*\* May 21, 2019**

(54) **GAMING MACHINE**  
(71) Applicant: **Everi Games Inc.**, Austin, TX (US)  
(72) Inventors: **Craig Stephen Gallagher**, Austin, TX (US); **Peter A. Phillips, Jr.**, Austin, TX (US); **Daniel C. Gibson**, Austin, TX (US); **Travis B. Bussey**, Austin, TX (US); **Rick Perez**, Austin, TX (US)

(73) Assignee: **Everi Games, Inc.**, Austin, TX (US)

(\*\*) Term: **15 Years**

(21) Appl. No.: **29/619,220**

(22) Filed: **Sep. 27, 2017**

(51) **LOC (11) Cl.** ..... **21-03**

(52) **U.S. Cl.**  
USPC ..... **D21/369**

(58) **Field of Classification Search**  
USPC ..... D21/369, 370, 371, 385, 329, 325, 394;  
D14/307, 172, 129, 325, 401, 371, 126,  
D14/439, 432, 450, 128, 375, 248, 374,  
D14/341, 138 G, 127; 463/28, 13, 11,  
463/16, 20, 25, 31, 46, 23, 30, 17, 36, 29,  
463/42, 34, 32, 35, 19, 21, 22; 273/292,  
273/203, 138.2, 143 R, 142 R, 138.1;  
D19/60; D16/226; D8/335, 331, 334;  
D26/141; D7/641  
CPC ..... G07F 17/32; G07F 17/34; G07F 17/3211;  
G07F 17/3244; G07F 17/3267  
See application file for complete search history.

(56) **References Cited**

U.S. PATENT DOCUMENTS

D498,267 S \* 11/2004 Crouch ..... D21/370  
D525,664 S \* 7/2006 Cole ..... D21/369  
D617,388 S \* 6/2010 Wildner ..... D21/325  
D673,619 S \* 1/2013 Seelig ..... D21/369

D673,620 S \* 1/2013 Johnson ..... D21/369  
D673,621 S \* 1/2013 Johnson ..... D21/369  
D723,626 S \* 3/2015 Vasquez ..... D21/370  
D763,361 S \* 8/2016 Rosander ..... D21/370  
9,704,337 B2 \* 7/2017 Riggs ..... G07F 17/3258  
D810,833 S \* 2/2018 Rosander ..... D21/370  
D813,954 S \* 3/2018 Calhoun ..... D21/369  
D826,338 S \* 8/2018 Bussey ..... D21/369  
2008/0113794 A1 \* 5/2008 Cole ..... G07F 17/32  
463/31  
2013/0084948 A1 \* 4/2013 Watkins ..... G07F 17/3276  
463/23  
2018/0082523 A1 \* 3/2018 Palermo ..... G07F 17/3216

\* cited by examiner

*Primary Examiner* — Ryan Harvey

(74) *Attorney, Agent, or Firm* — The Culbertson Group, P.C.

(57) **CLAIM**

The ornamental design for a gaming machine, as shown and described.

**DESCRIPTION**

FIG. 1 is a perspective view from above of a gaming machine showing the new design.  
FIG. 2 is a front elevational view of the gaming machine shown in FIG. 1.  
FIG. 3 is a rear elevational view of the gaming machine shown in FIG. 1.  
FIG. 4 is a left side elevational view of the gaming machine shown in FIG. 1.  
FIG. 5 is a right side elevational view of the gaming machine shown in FIG. 1.  
FIG. 6 is a top plan view of the gaming machine shown in FIG. 1; and,  
FIG. 7 is a bottom plan view of the gaming machine shown in FIG. 1.  
The broken line showing of portions of the gaming machine depict features, which form no part of the claim.

**1 Claim, 6 Drawing Sheets**

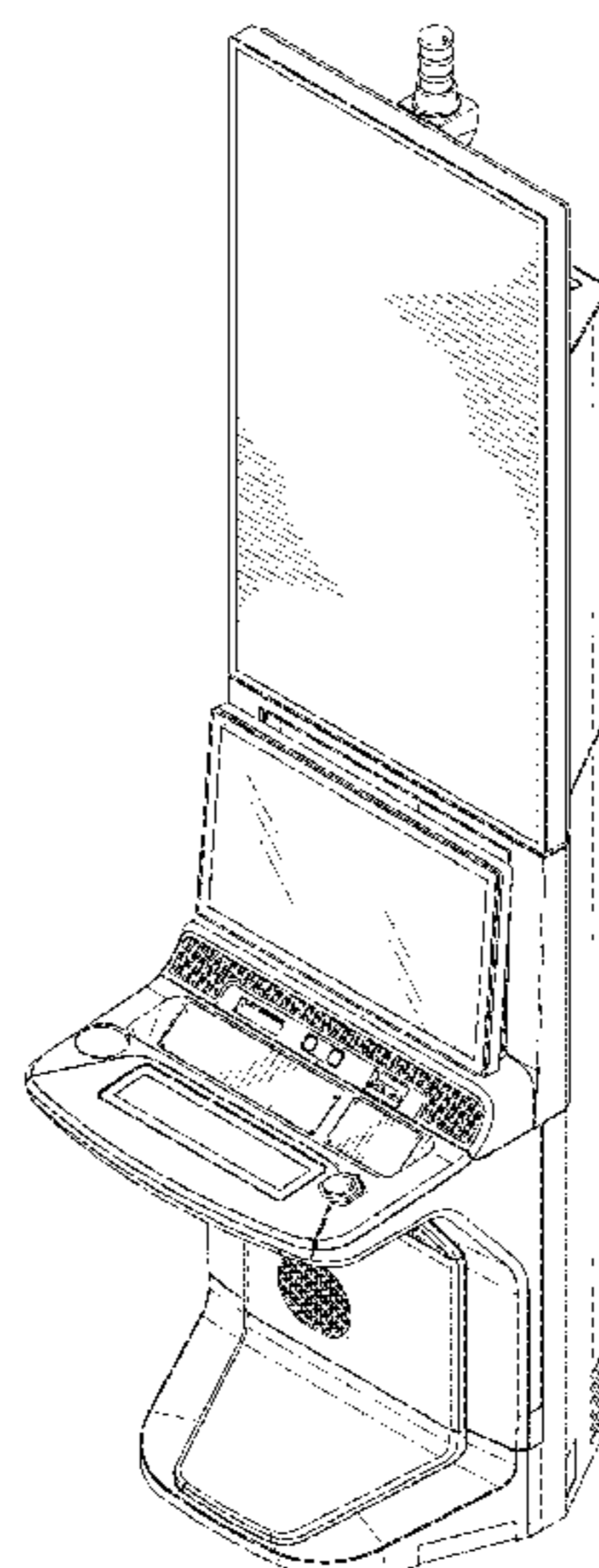

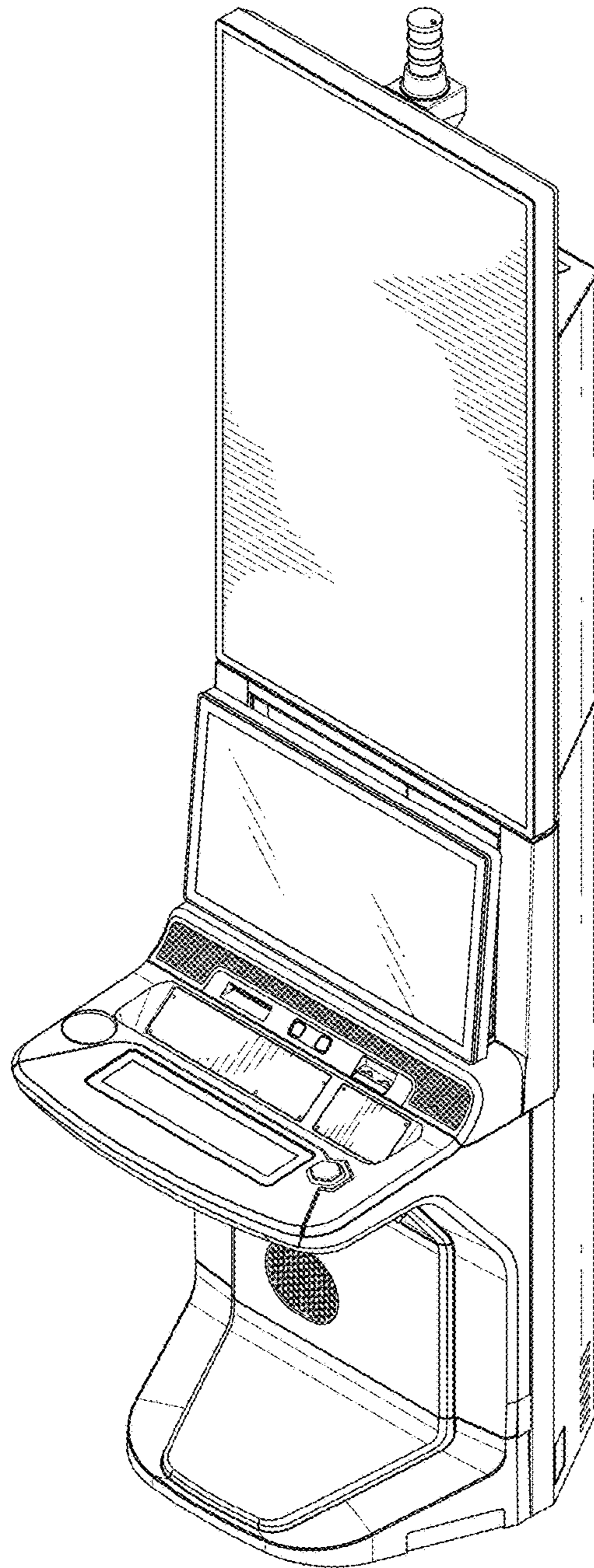

FIG. 1

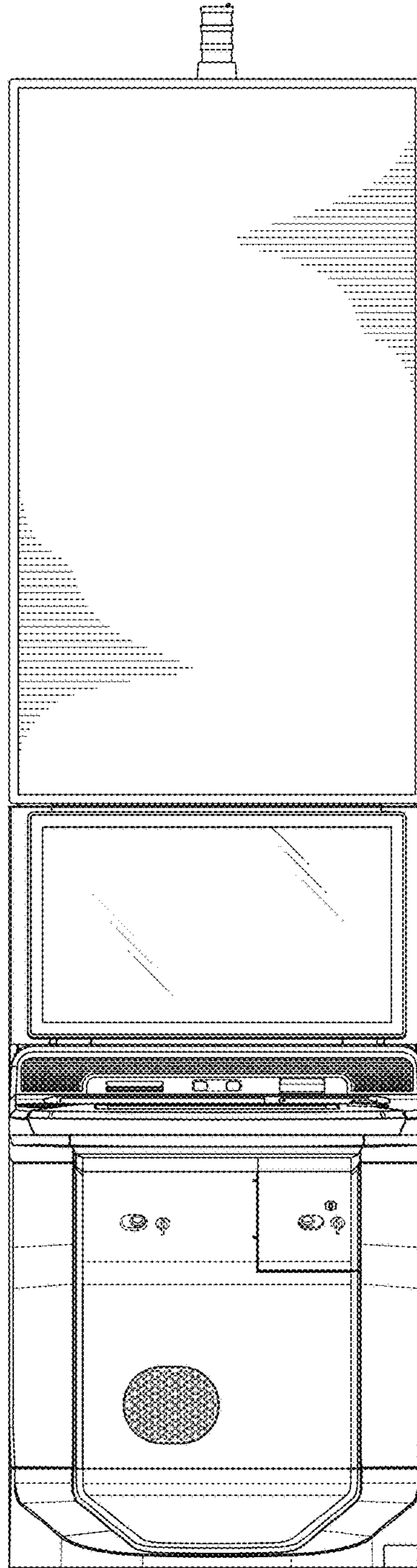

FIG.2

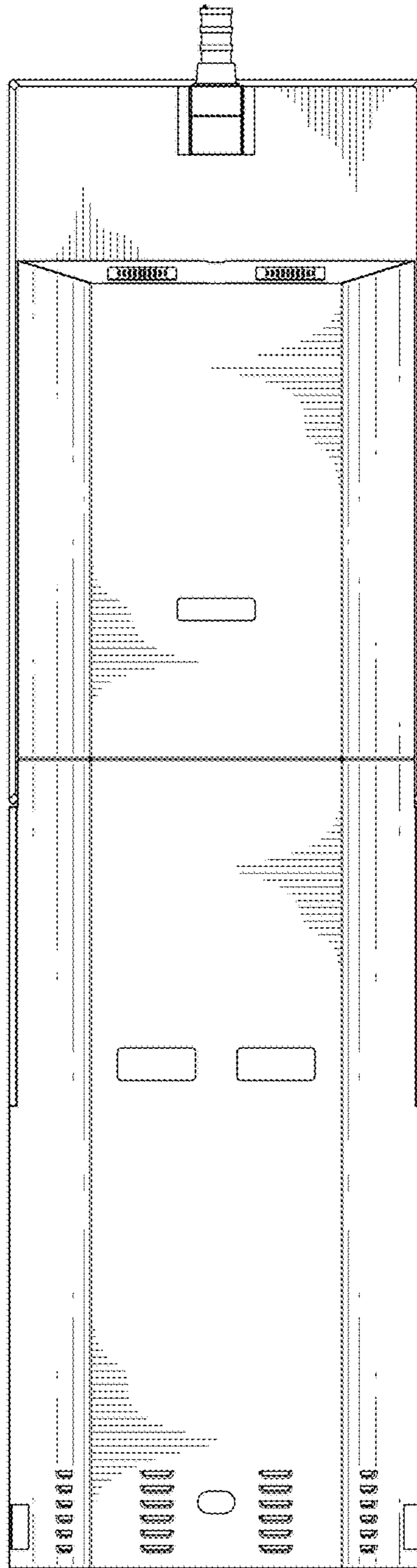

FIG.3

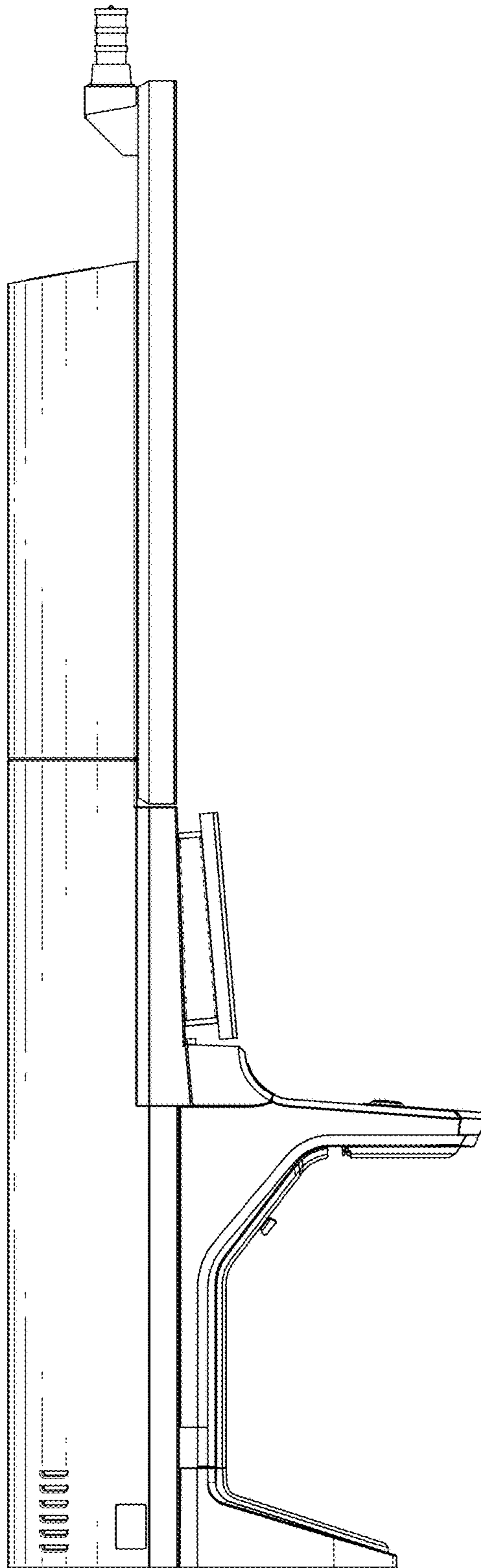

FIG.4

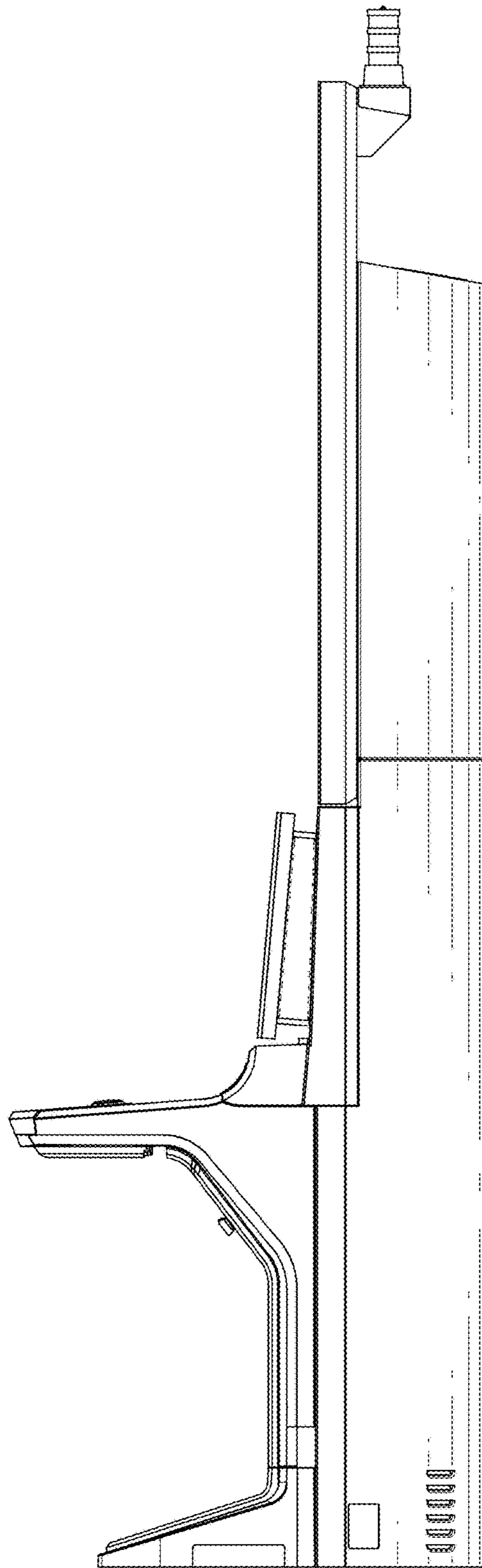

FIG. 5

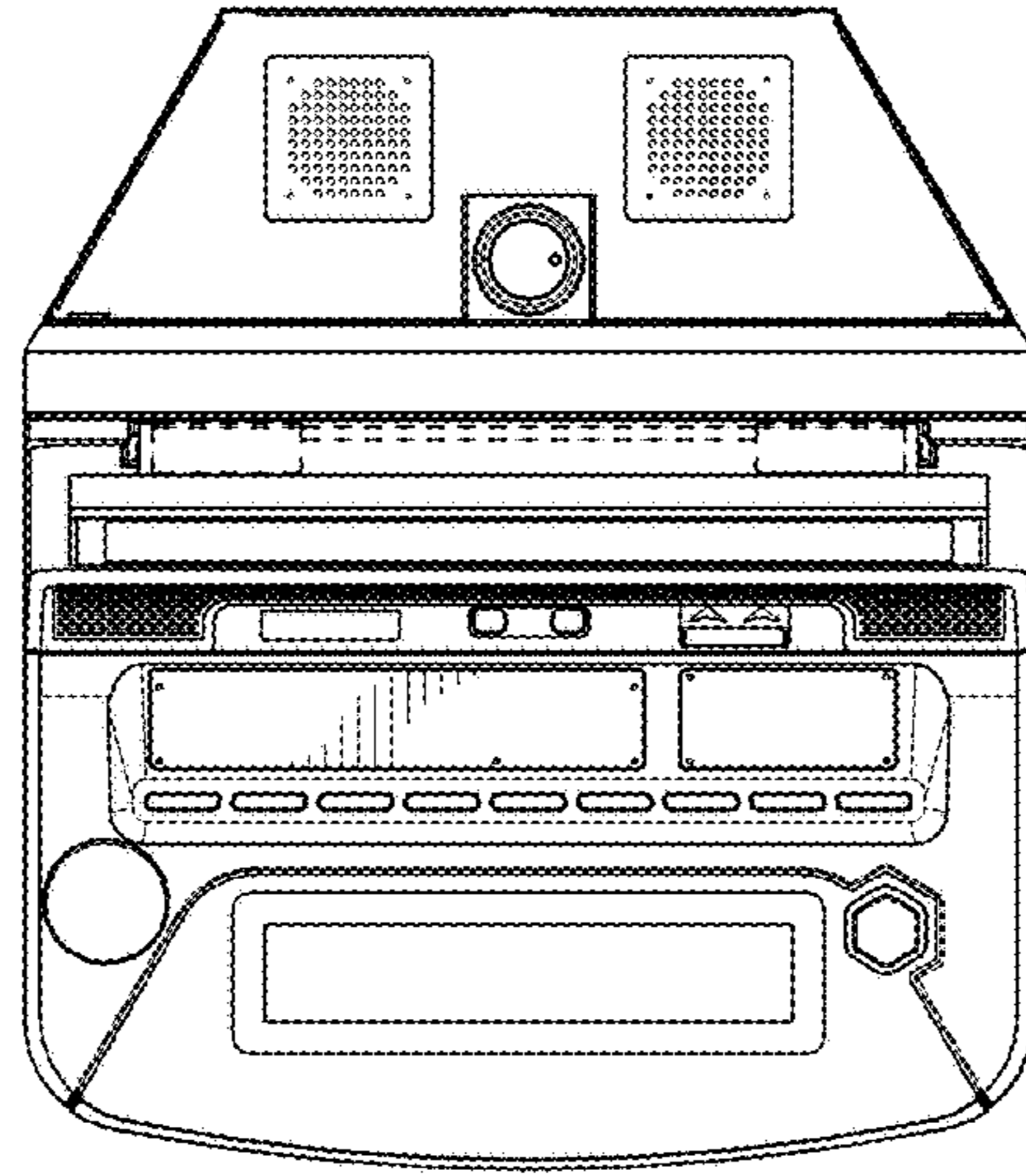

FIG. 6

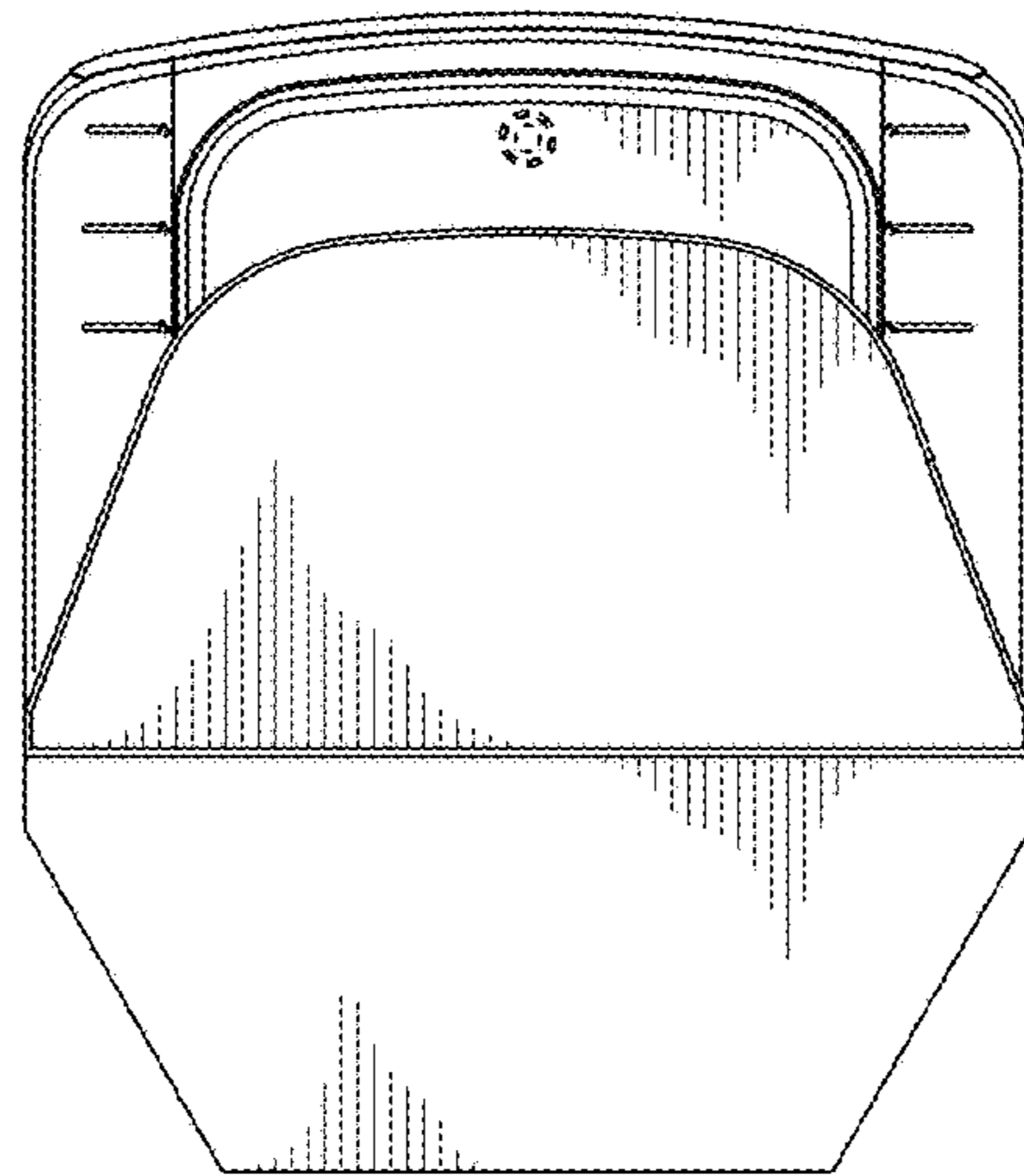

FIG. 7