

US00D848954S

(12) **United States Design Patent** (10) **Patent No.:** **US D848,954 S**  
**Chadbourne et al.** (45) **Date of Patent:** **\*\* May 21, 2019**

(54) **FIBER AND HOUSING ASSEMBLY**

(71) Applicant: **Molex, LLC**, Lisle, IL (US)

(72) Inventors: **Richard Chadbourne**, Lisle, IL (US);  
**Rachel Low**, LaGrange, IL (US)

(73) Assignee: **Molex, LLC**, Lisle, IL (US)

(\*\*) Term: **15 Years**

(21) Appl. No.: **29/630,354**

(22) Filed: **Dec. 20, 2017**

(51) **LOC (11) Cl.** ..... **13-03**

(52) **U.S. Cl.**  
USPC ..... **D13/154**; D13/153

(58) **Field of Classification Search**  
USPC ..... D13/133, 153, 154, 155, 156; D14/205,  
D14/218; D26/27  
CPC .. G02B 6/3833; G02B 6/3834; G02B 6/3838;  
G02B 6/3841; G02B 6/387; G02B  
6/4292; H01R 13/025; H01R 13/46  
See application file for complete search history.

(56) **References Cited**

U.S. PATENT DOCUMENTS

5,577,145 A \* 11/1996 Musk ..... G02B 6/3877  
385/78  
D388,053 S \* 12/1997 Robertson, Jr. .... D13/133  
D400,170 S \* 10/1998 Asai ..... D13/133  
D413,860 S \* 9/1999 Matthews ..... D13/133  
D436,935 S \* 1/2001 Feucht ..... D13/133  
D446,778 S \* 8/2001 Feucht ..... D13/133  
D480,688 S \* 10/2003 Lin ..... D13/147  
D508,232 S \* 8/2005 Suckle ..... D13/156  
D513,735 S \* 1/2006 Nishio ..... D13/147  
D519,934 S \* 5/2006 Wada ..... D13/156  
D556,146 S \* 11/2007 Victor ..... D13/133  
D582,353 S \* 12/2008 Victor ..... D13/156  
7,484,990 B1 \* 2/2009 Lee ..... H01R 13/585  
439/369  
D598,865 S \* 8/2009 Hwang ..... D13/156

D668,225 S \* 10/2012 Lyford ..... D13/133  
D671,892 S \* 12/2012 Keith, Jr. .... D13/133  
D674,345 S \* 1/2013 Izen ..... D13/133  
D678,198 S \* 3/2013 Izen ..... D13/133  
D689,437 S \* 9/2013 Lyford ..... D13/133  
D691,095 S \* 10/2013 Izen ..... D13/147  
D699,193 S \* 2/2014 Zeller ..... D13/155  
D714,220 S \* 9/2014 Izen ..... D13/133  
D718,273 S \* 11/2014 Harata ..... D14/205  
D731,456 S \* 6/2015 Dahlberg ..... D14/205  
D737,217 S \* 8/2015 Leidolt ..... D13/153  
9,146,364 B2 \* 9/2015 Chen ..... G02B 6/387  
D754,067 S \* 4/2016 Kovacs ..... D13/133  
D772,231 S \* 11/2016 Lee ..... D13/133  
D777,105 S \* 1/2017 Romandy ..... D13/133  
D782,998 S \* 4/2017 Shin ..... D14/205  
2014/0169742 A1 \* 6/2014 Bhagavatula ..... G02B 6/3821  
385/52

\* cited by examiner

*Primary Examiner* — Selina Sikder  
(74) *Attorney, Agent, or Firm* — Banner & Witcoff, Ltd.

(57) **CLAIM**

The ornamental design for a fiber and housing assembly, as shown and described.

**DESCRIPTION**

FIG. 1 is a top perspective view of a fiber and housing assembly showing our new design;  
 FIG. 2 is a top view thereof;  
 FIG. 3 is a bottom view thereof;  
 FIG. 4 is a right side view thereof;  
 FIG. 5 is a left side view thereof;  
 FIG. 6 is a front view thereof; and,  
 FIG. 7 is a rear view thereof.  
 The broken lines in the drawings depict portions of the illuminated fiber housing assembly that form no part of the claimed design.

**1 Claim, 7 Drawing Sheets**

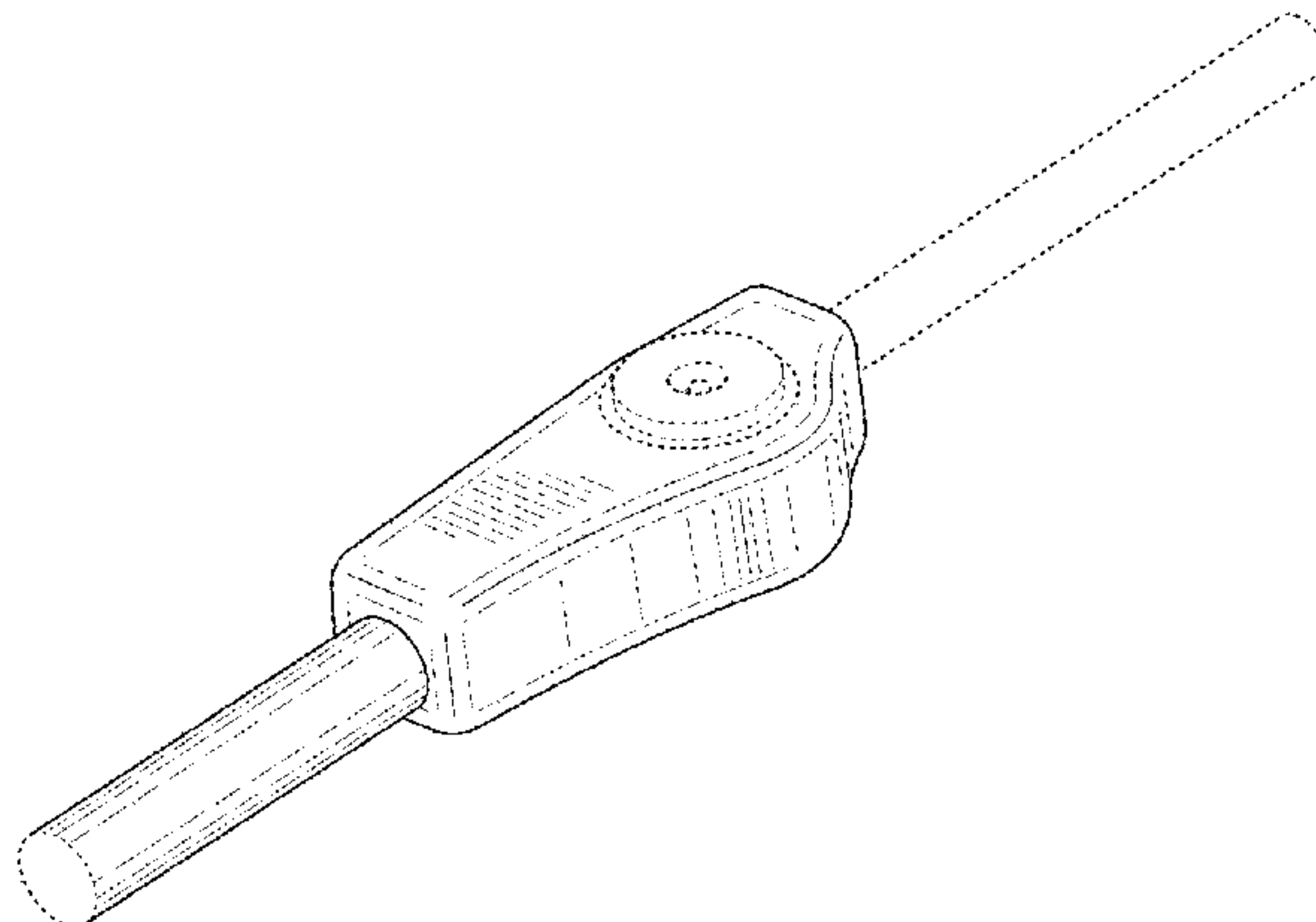

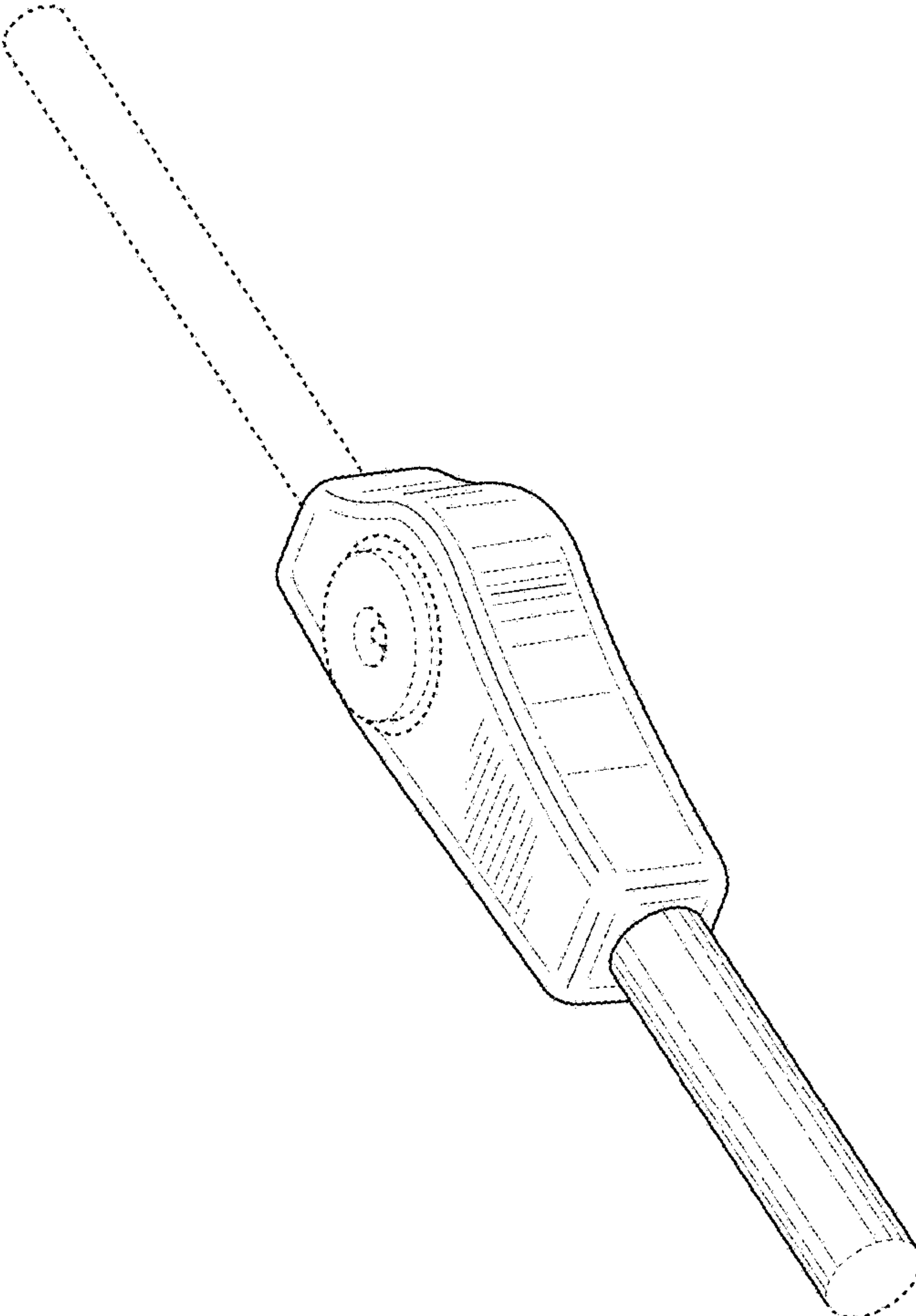

FIG. 1

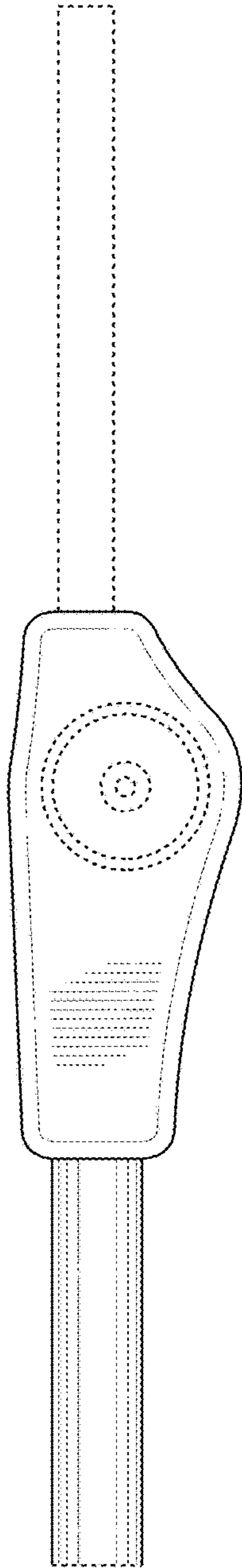

FIG. 2

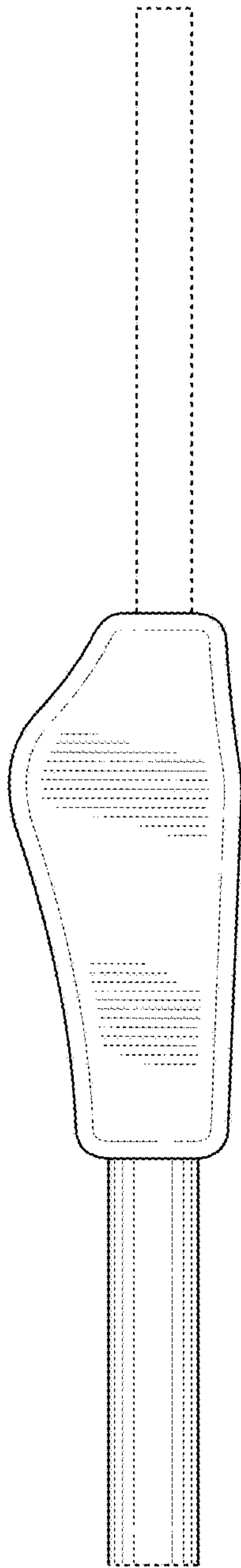

FIG. 3

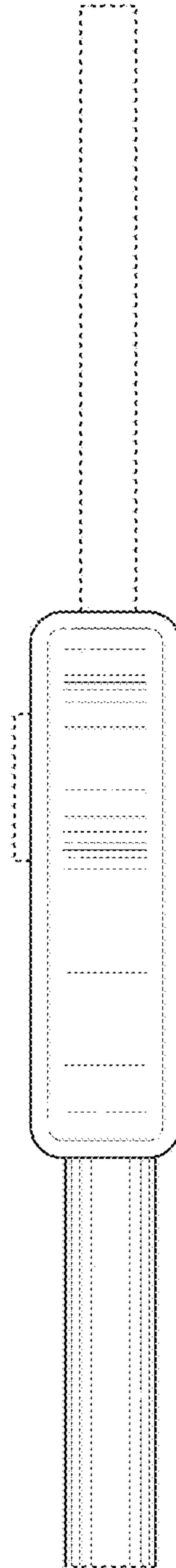

FIG. 4

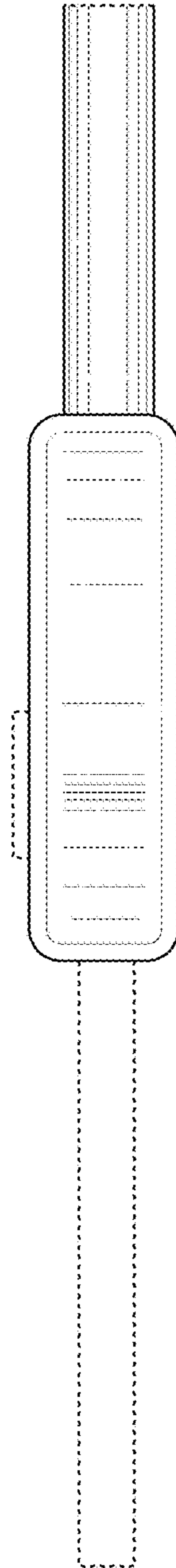

FIG. 5

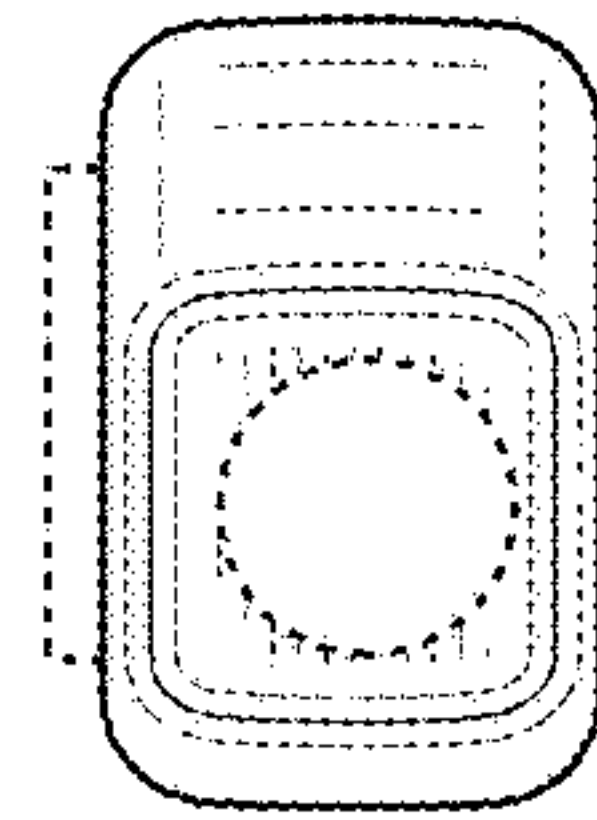

FIG. 6

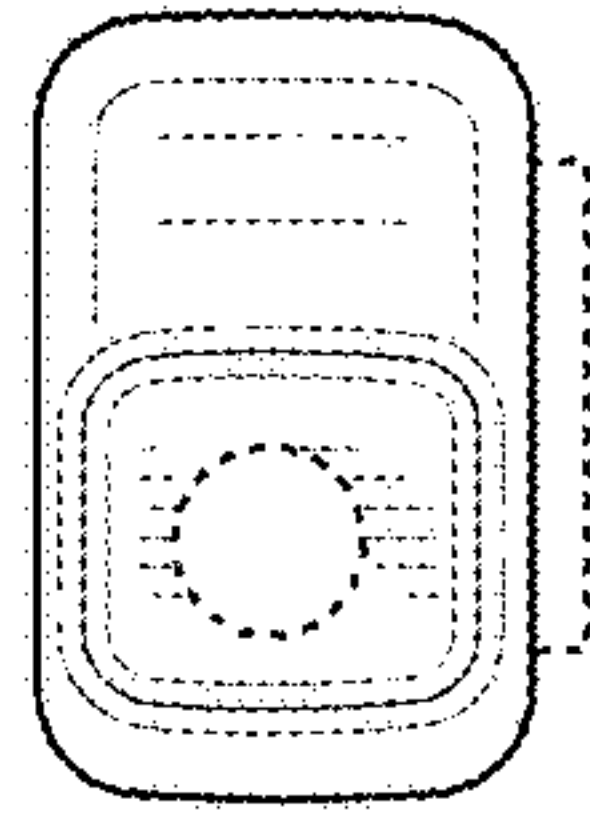

FIG. 7