



US00D848880S

(12) **United States Design Patent**  
**Smith et al.**

(10) **Patent No.:** **US D848,880 S**  
(45) **Date of Patent:** **\*\* May 21, 2019**

(54) **BIOCHEMICAL ANALYSIS APPARATUSES**

(71) Applicant: **IntegenX, Inc.**, Pleasanton, CA (US)

(72) Inventors: **Corey M. Smith**, Los Altos, CA (US);  
**Tracy Lee Dahlmann**, Livermore, CA (US);  
**Daniel M. Parker**, Fremont, CA (US);  
**Robert A. Schueren**, Los Altos Hills, CA (US);  
**David King**, Menlo Park, CA (US)

(73) Assignee: **IntegenX Inc.**, Pleasanton, CA (US)

(\*\*) Term: **15 Years**

(21) Appl. No.: **29/616,150**

(22) Filed: **Sep. 1, 2017**

(51) **LOC (11) Cl.** ..... **10-04**

(52) **U.S. Cl.**  
USPC ..... **D10/81; D24/234; D24/216**

(58) **Field of Classification Search**  
USPC ..... **D24/107, 169, 185, 186, 216-219,**  
**D24/231-234; D10/81**

(Continued)

(56) **References Cited**

**U.S. PATENT DOCUMENTS**

D421,653 S 3/2000 Purcell  
D467,349 S 12/2002 Niedbala et al.

(Continued)

**FOREIGN PATENT DOCUMENTS**

CN 303778667 S 8/2016  
EM 004733517-0001 10/2015

**OTHER PUBLICATIONS**

U.S. Restriction Requirement dated Apr. 13, 2016 in U.S. Appl. No. 29/525,151.

(Continued)

*Primary Examiner* — Antoine Duval Davis

(74) *Attorney, Agent, or Firm* — Workman Nydegger

(57) **CLAIM**

We claim the ornamental design for a biochemical analysis apparatuses, as shown and described.

**DESCRIPTION**

FIG. 1 is an isometric view of a first biochemical analysis apparatus.

FIG. 2 is a front view of the first biochemical analysis apparatus of FIG. 1.

FIG. 3 is a side view of the first biochemical analysis apparatus of FIG. 1.

FIG. 4 is a back view of the first biochemical analysis apparatus of FIG. 1.

FIG. 5 is an opposing side view of the first biochemical analysis apparatus of FIG. 1.

FIG. 6 is a top view of the first biochemical analysis apparatus of FIG. 1.

FIG. 7 is a bottom view of the first biochemical analysis apparatus of FIG. 1.

FIG. 8 is an off angle isometric view of the first biochemical analysis apparatus of FIG. 1.

FIG. 9 is another off angle view of the first biochemical analysis apparatus of FIG. 1.

FIG. 10 is an isometric view of a second biochemical analysis apparatus.

FIG. 11 is a front view of the second biochemical analysis apparatus of FIG. 10.

FIG. 12 is a side view of the second biochemical analysis apparatus of FIG. 10.

FIG. 13 is a back view of the second biochemical analysis apparatus of FIG. 10.

FIG. 14 is an opposing side view of the second biochemical analysis apparatus of FIG. 10.

FIG. 15 is a top view of the second biochemical analysis apparatus of FIG. 10.

FIG. 16 is a bottom view of the second biochemical analysis apparatus of FIG. 10.

FIG. 17 is an off angle isometric view of the second biochemical analysis apparatus of FIG. 10.

(Continued)

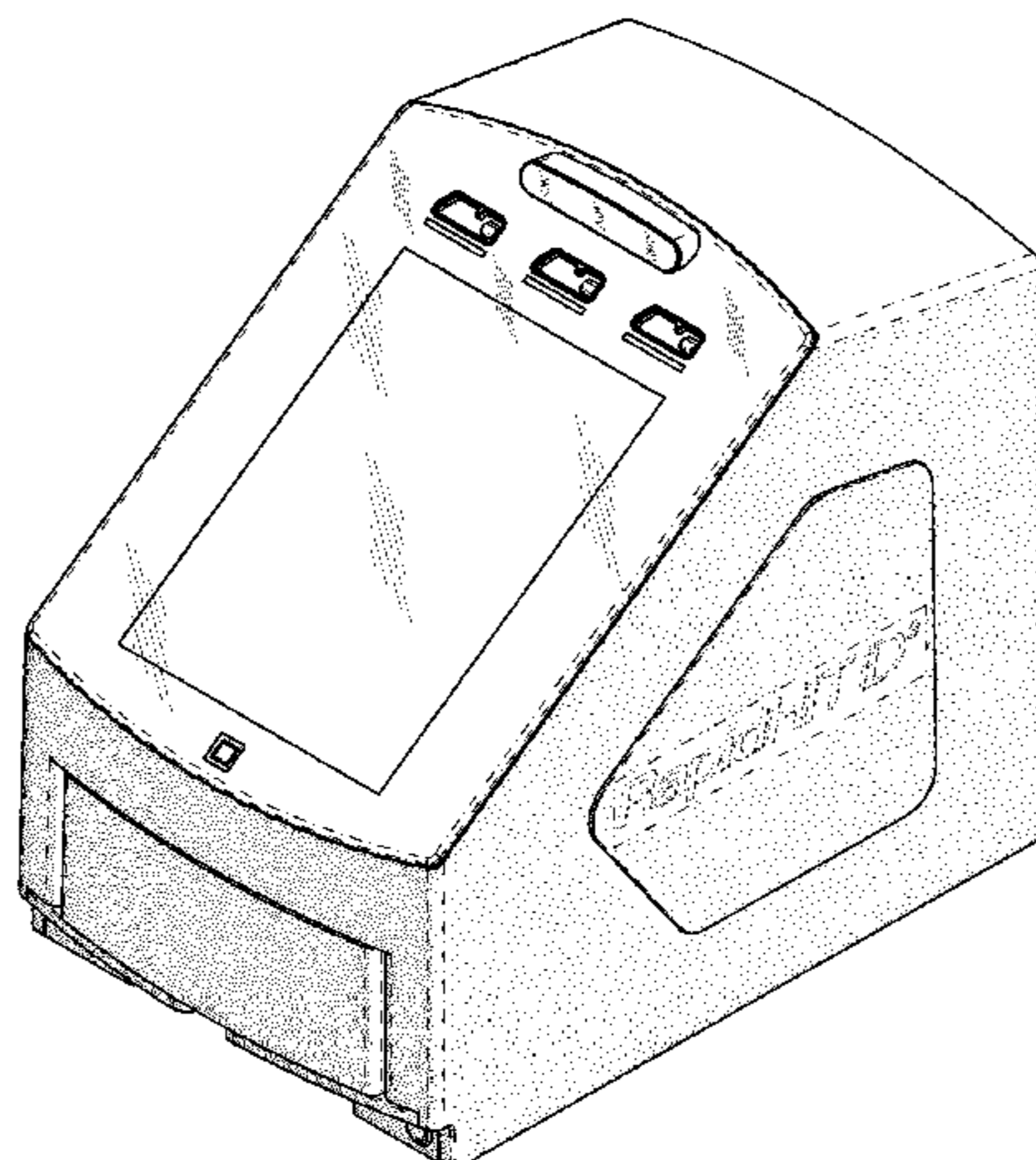

FIG. 18 is another off angle view of the second biochemical analysis apparatus of FIG. 10; and, FIG. 19 is a front view of both the first biochemical analysis apparatus of FIG. 1 and the second biochemical analysis apparatus of FIG. 10.

A first biochemical analysis apparatus is shown in FIGS. 1-9 and a second biochemical analysis apparatus is shown in FIGS. 10-18.

Stipple shading is used throughout to show surface contouring and not texture.

The broken line showing of structural features is included for the purpose of illustrating non-claimed subject matter and forms no part of the claimed design. For example, the text on the sides of the first apparatus and the second apparatus is unclaimed subject matter as indicated by such items being depicted as dotted, or broken, lines and surrounded by a dash-dot-dot boundary rectangle. The dash-dot-dot boundary indicates a transition between claimed and unclaimed subject matter.

**1 Claim, 13 Drawing Sheets**

(58) **Field of Classification Search**

CPC ..... Y10T 436/00; Y10T 436/10; Y10T 436/100833; Y10T 436/101666; Y10T 436/102499; Y10T 436/103332; Y10T 436/104165; Y10T 436/104998; Y10T 436/105831; Y10T 436/106664; Y10T 436/107497; Y10T 436/108331; Y10T 436/109163; Y10T 436/11; Y10T 436/110833; Y10T 436/111666; Y10T 436/112499; Y10T 436/113332; Y10T 436/114165; Y10T 436/114998; Y10T 436/115831; Y10T 436/116664; Y10T 436/117497; Y10T 436/118339; Y10T 436/119163; Y10T 436/12; Y10T 436/13; Y10T 436/14; Y10T 436/141111; Y10T 436/142222; Y10T 436/143333; Y10T 436/144444; Y10T 436/145555; Y10T 436/146666; Y10T 436/147777; Y10T 436/148888; Y10T 436/15; Y10T 436/153333; Y10T 436/156666; Y10T 436/17; Y10T 436/170769; Y10T 436/171538; Y10T 436/172307; Y10T 436/173076; Y10T 436/173845; Y10T 436/174614; Y10T 436/175383; Y10T 436/176152; Y10T 436/176921; Y10T 436/177692; Y10T 436/178459; Y10T 436/179228; Y10T 436/18; Y10T 436/182; Y10T 436/184; Y10T 436/186; Y10T 436/188; Y10T 436/19; Y10T 436/193333; Y10T 436/196666; Y10T 436/20; Y10T 436/200833; Y10T 436/201666; Y10T 436/202499; Y10T 436/203332; Y10T 436/204165; Y10T 436/204998; Y10T 436/205831; Y10T

436/206664; Y10T 436/207497; Y10T 436/208339; Y10T 436/209163; Y10T 436/21; Y10T 436/212; Y10T 436/214; Y10T 436/216; Y10T 436/218; Y10T 436/22; Y10T 436/23; Y10T 436/235; Y10T 436/24; Y10T 436/25; Y10T 436/25125; Y10T 436/2525; Y10T 436/25375; Y10T 436/255; Y10T 436/25625; Y10T 436/2575; Y10T 436/25875; G01N 27/44791; G01N 27/44743; G01N 27/44786; G01N 27/453; B01L 3/502715; B01L 2400/0421

See application file for complete search history.

(56)

**References Cited**

U.S. PATENT DOCUMENTS

D474,280	S	5/2003	Niedbala et al.
D556,914	S	12/2007	Okamoto et al.
7,776,195	B2	8/2010	Kureshy et al.
RE41,946	E	11/2010	Anderson et al.
D631,968	S	2/2011	Sevel
D689,193	S	9/2013	Shinohara et al.
D730,535	S	5/2015	Gutmann et al.
8,986,527	B2	6/2015	Lin et al.
D733,917	S	7/2015	Klein et al.
D737,702	S	9/2015	Selberg et al.
9,128,072	B2	9/2015	Dießel et al.
9,145,573	B2	9/2015	Pederson
D740,434	S	10/2015	Isozaki
D772,086	S	11/2016	Schueren et al.
D775,365	S *	12/2016	Mathers ..... D24/232
9,562,902	B2 *	2/2017	Hoogenboom ..... C07K 16/00
9,562,920	B2	2/2017	Asao et al.
9,658,222	B2 *	5/2017	Moll ..... G01N 33/54373
D794,211	S *	8/2017	Ang ..... D24/232
D818,146	S *	5/2018	Tanaka ..... D24/216
D819,225	S *	5/2018	Mead ..... D24/233
9,968,934	B2 *	5/2018	Kim ..... B01L 3/502715
D819,470	S *	6/2018	Schueren ..... D10/81
D821,601	S *	6/2018	Henderson ..... D24/216
D822,844	S *	7/2018	Smith ..... D24/216
D827,859	S *	9/2018	Mathers ..... D24/232
D833,033	S *	11/2018	Foster ..... D24/233
D834,724	S	11/2018	Mathers

OTHER PUBLICATIONS

U.S. Restriction Requirement dated Jun. 22, 2016 in U.S. Appl. No. 29/525,151.  
 U.S. Notice of Allowance dated Sep. 2, 2016 in U.S. Appl. No. 29/525,151.  
 U.S. Restriction Requirement dated Oct. 5, 2017 in U.S. Appl. No. 29/581,062.  
 U.S. Notice of Allowance dated Feb. 8, 2018 in U.S. Appl. No. 29/581,062.  
 Photographs of Prototype, Dec. 2016.  
 U.S. Appl. No. 29/650,002, filed Jun. 4, 2018, Schueren et al.  
 U.S. Restriction Requirement dated Jan. 14, 2019, issued for U.S. Appl. No. 29/650,002.

\* cited by examiner



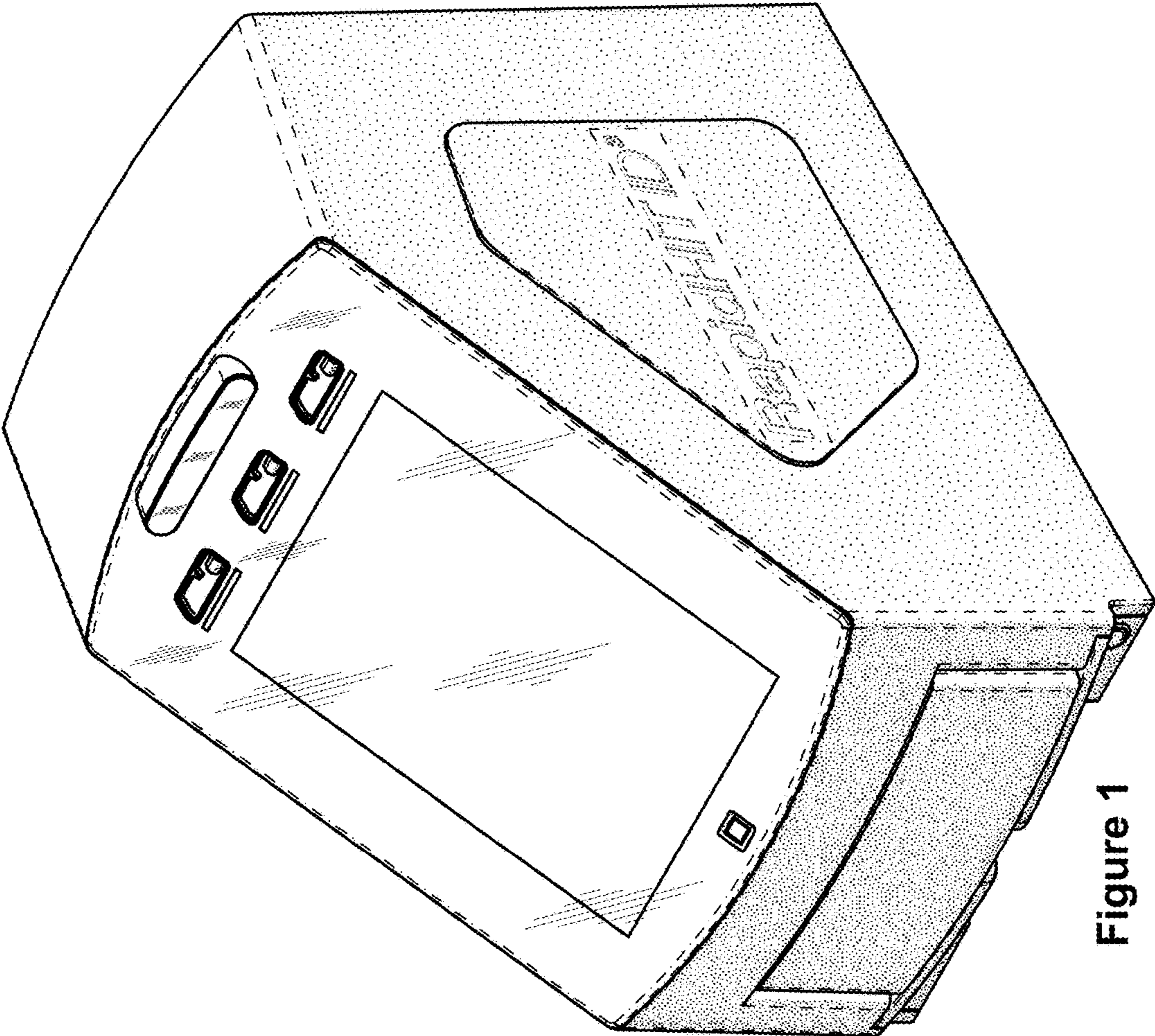

Figure 1

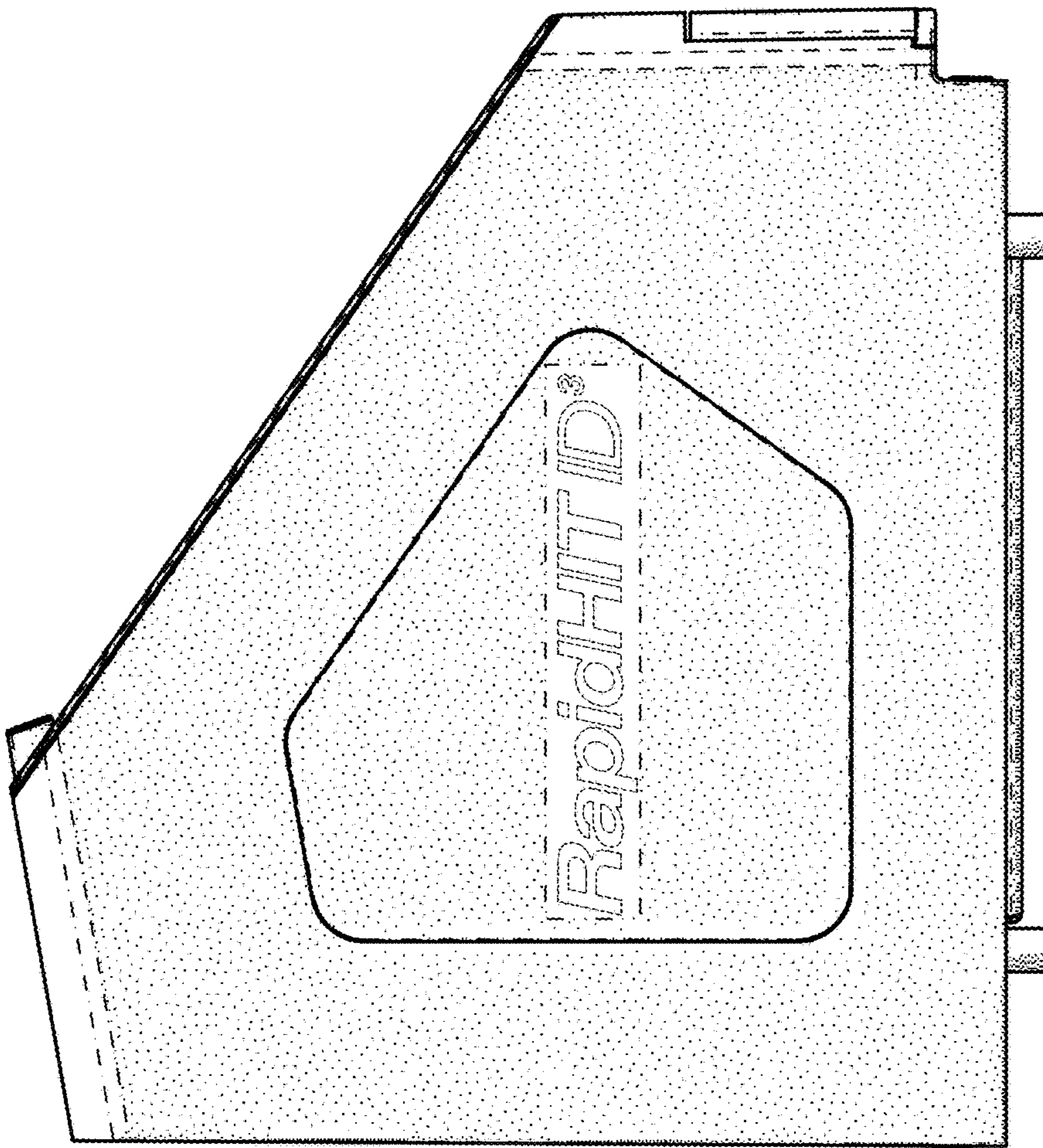

Figure 3

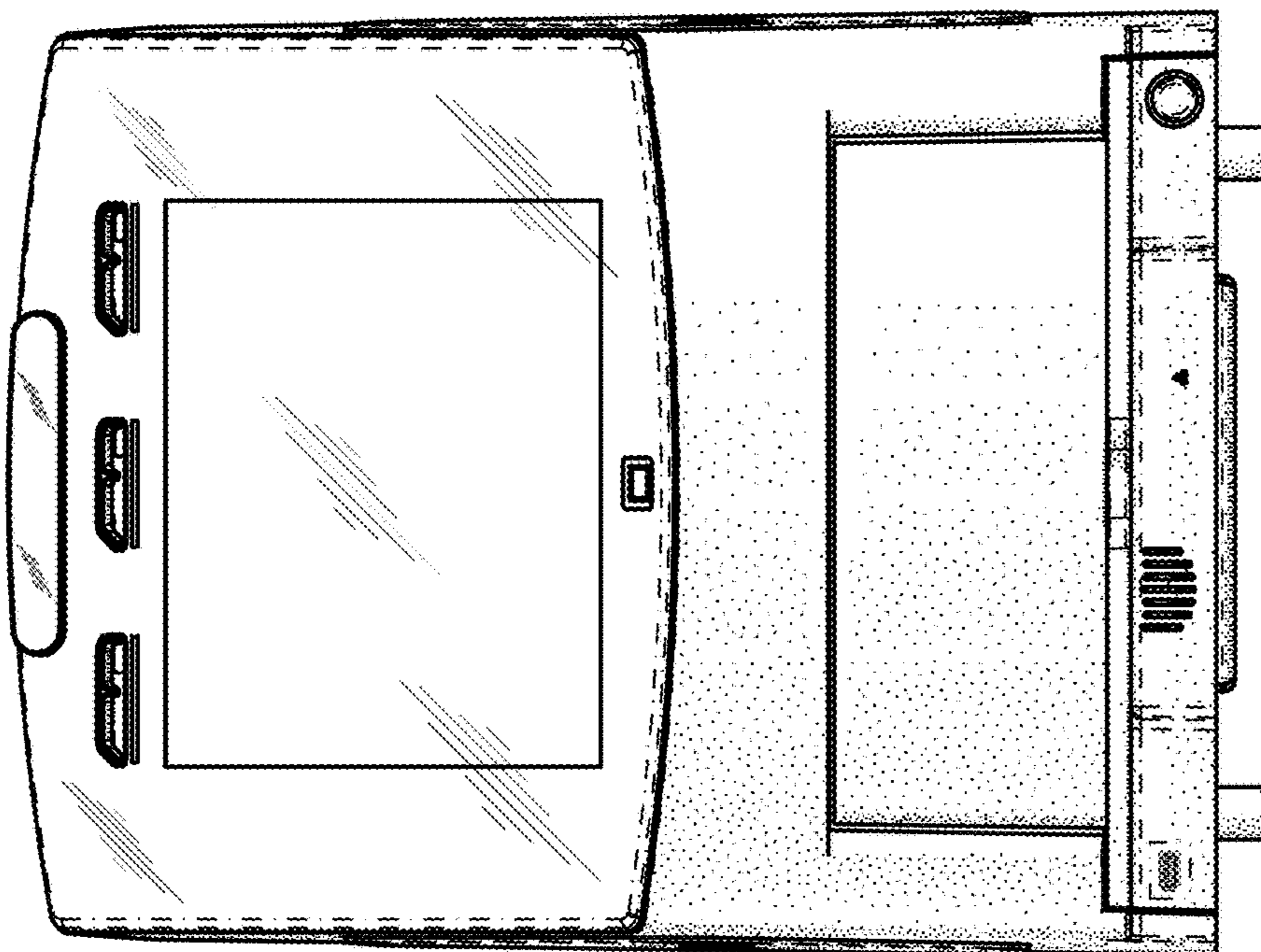

Figure 2



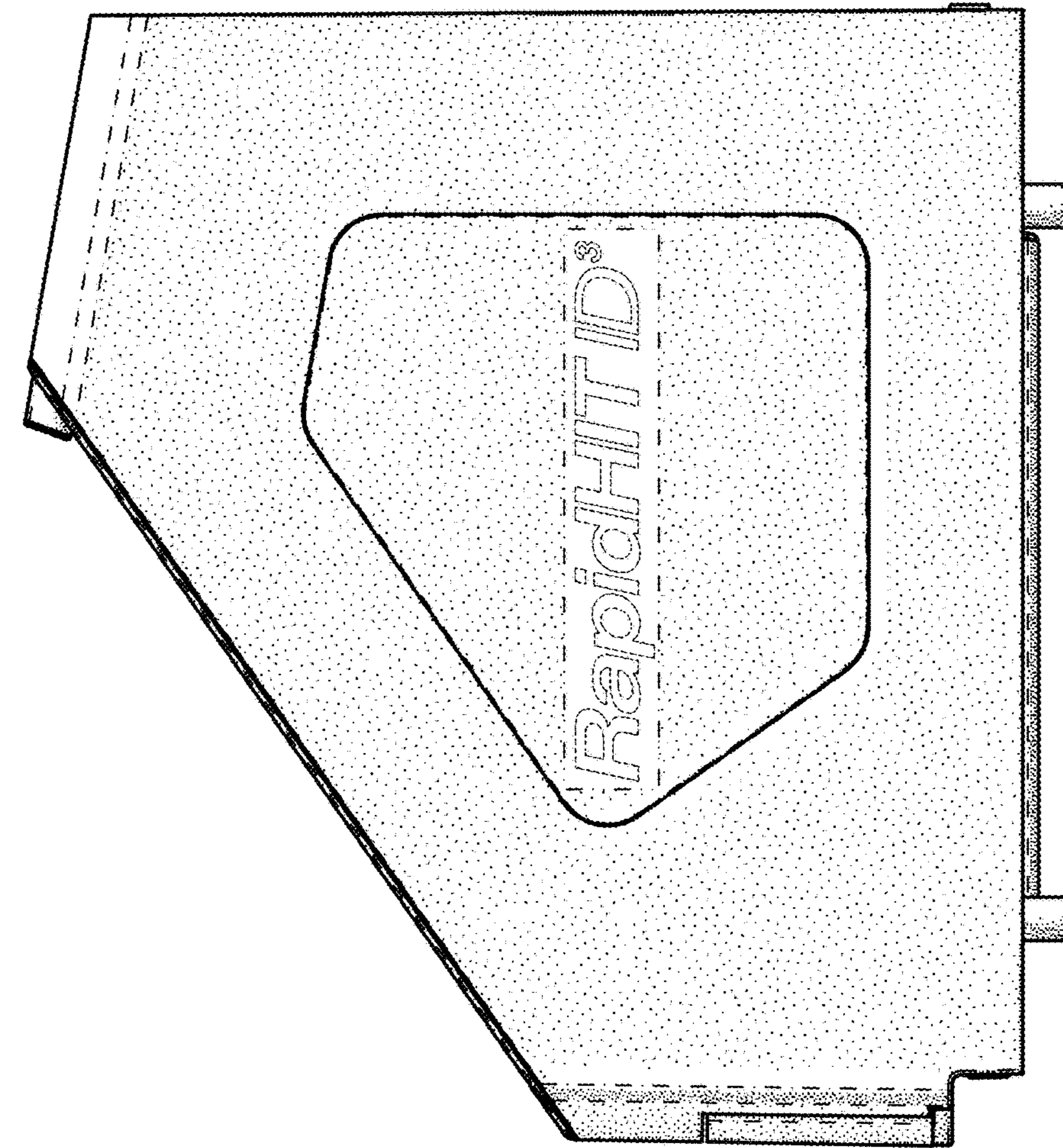

Figure 5

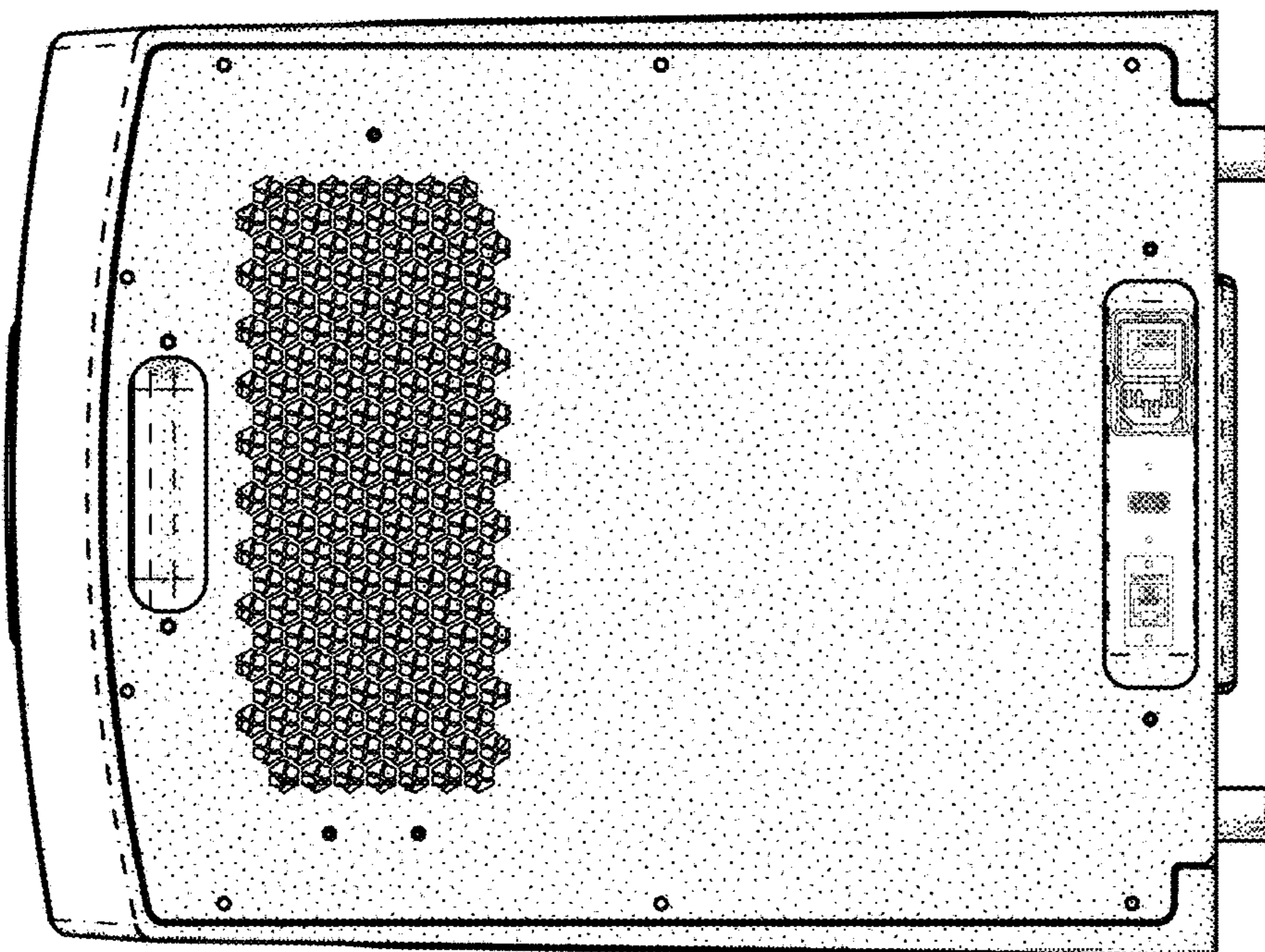

Figure 4

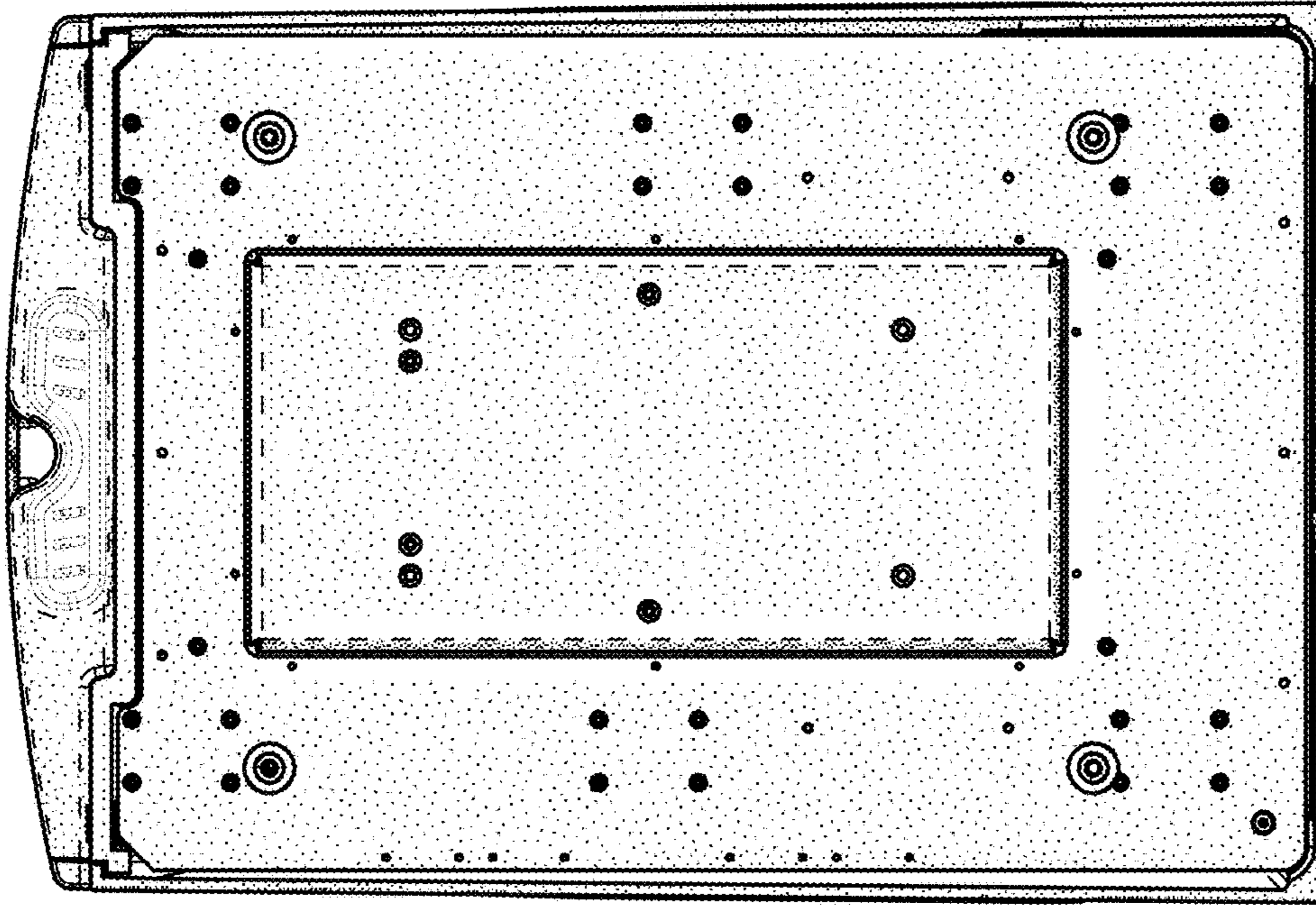

Figure 7

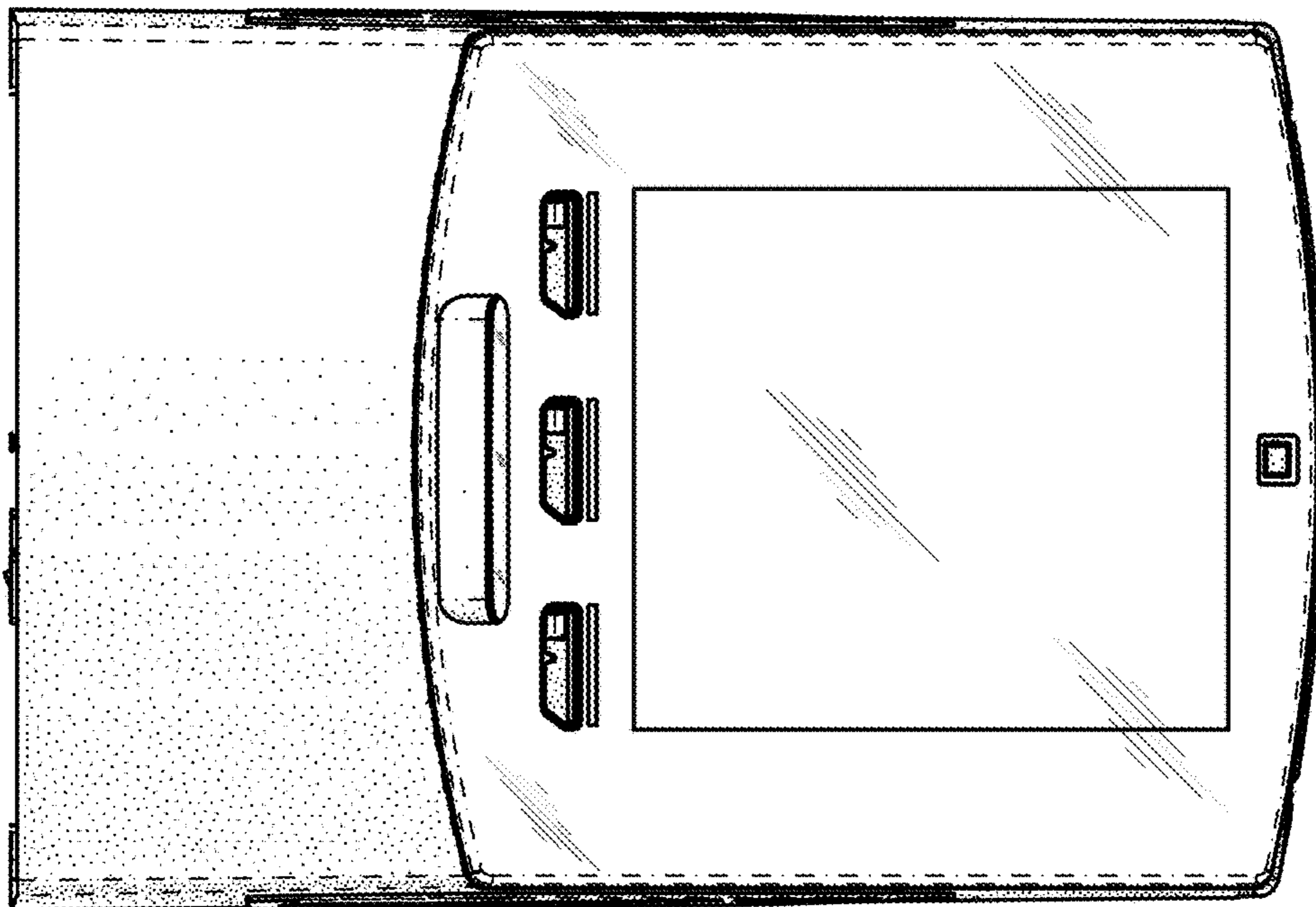

Figure 6



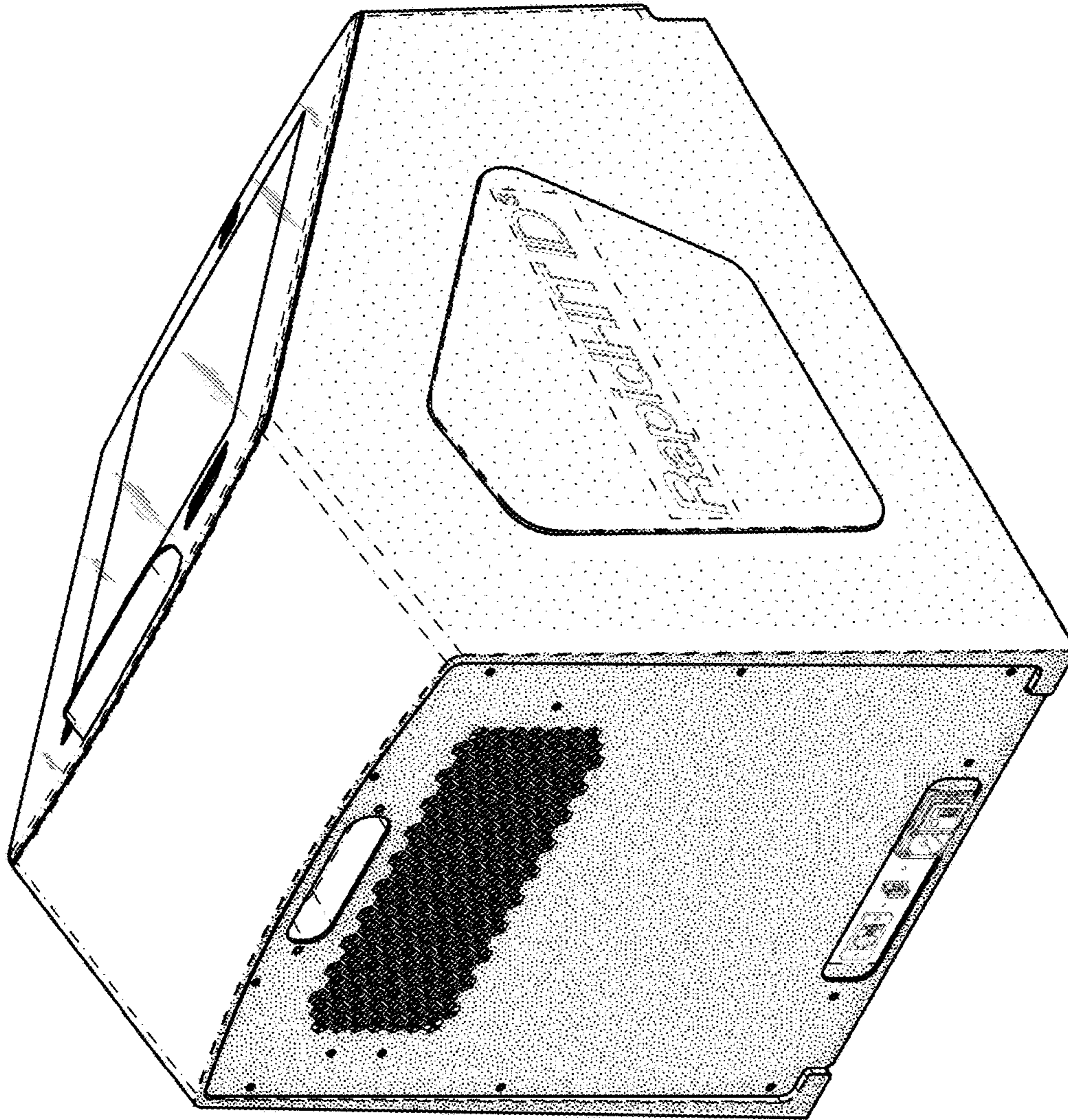

Figure 8

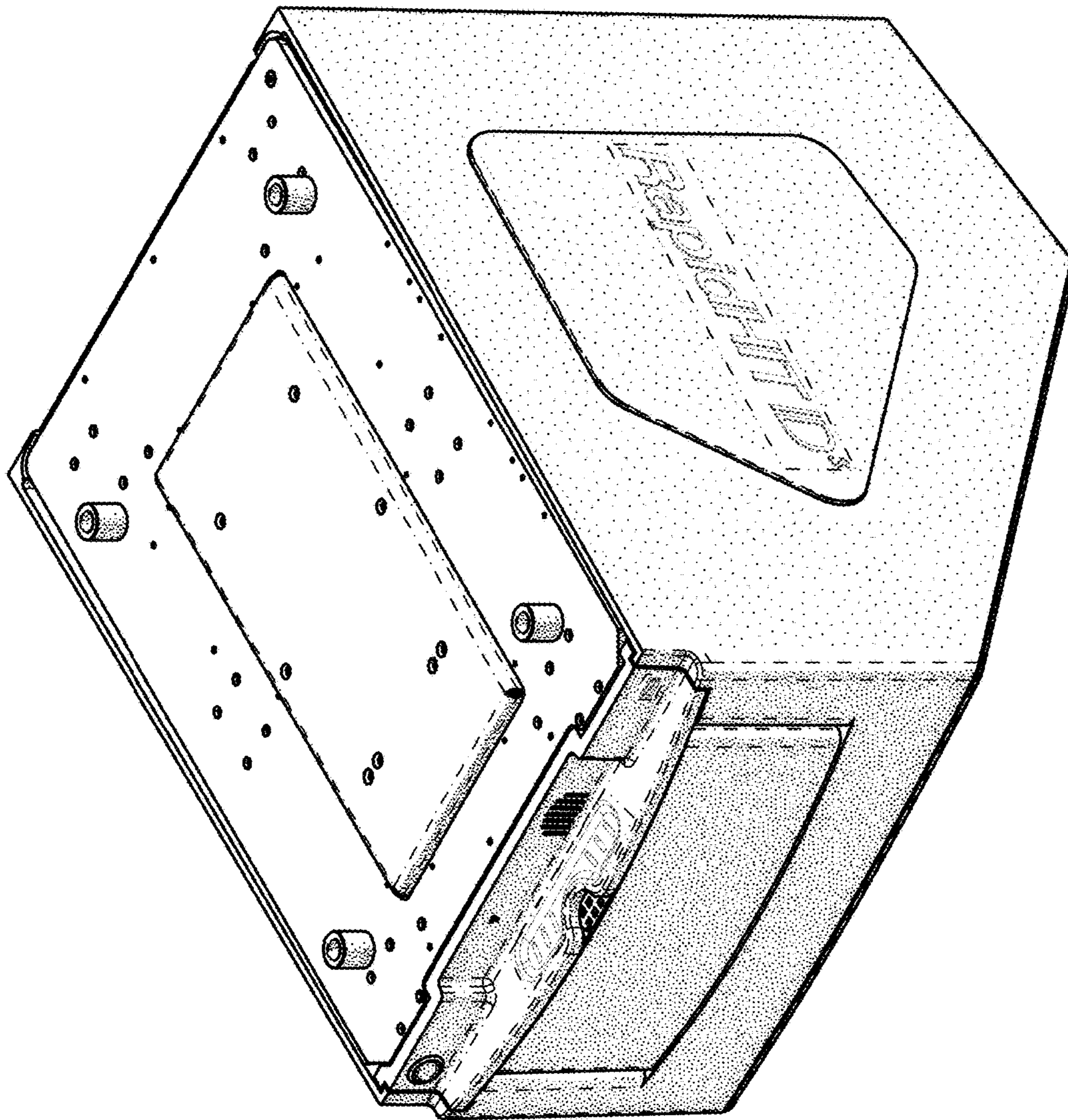

Figure 9



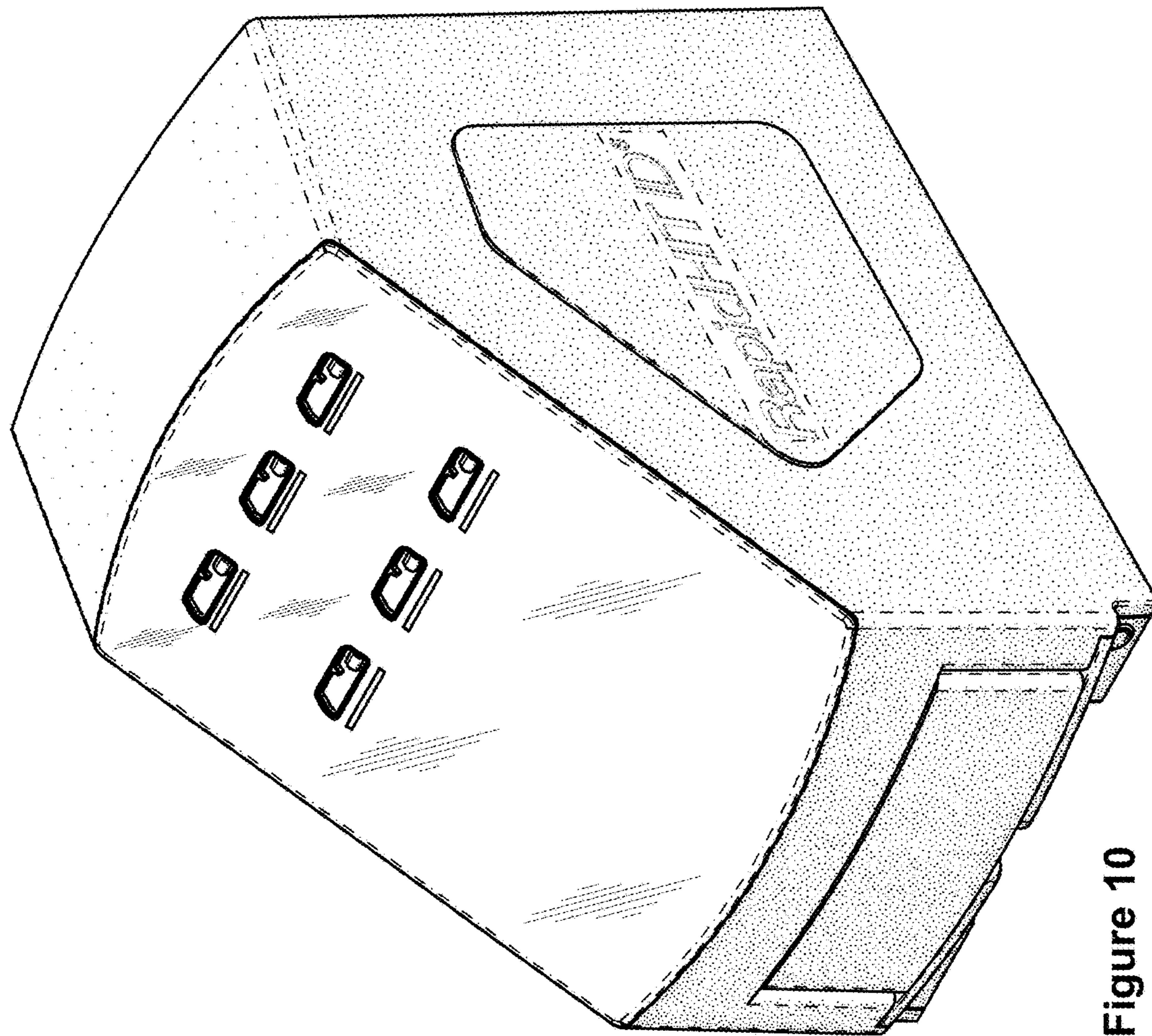

Figure 10

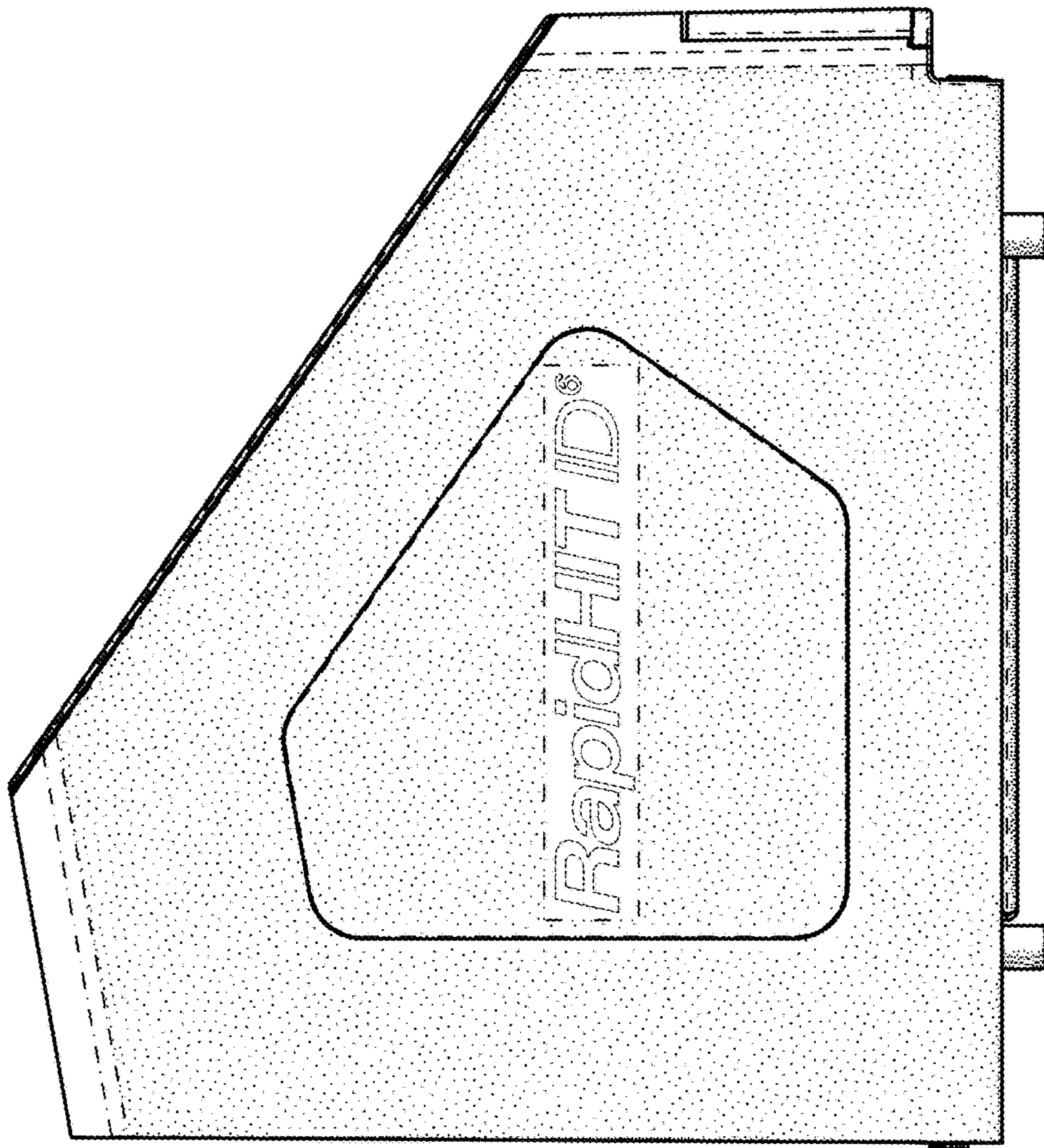

Figure 12

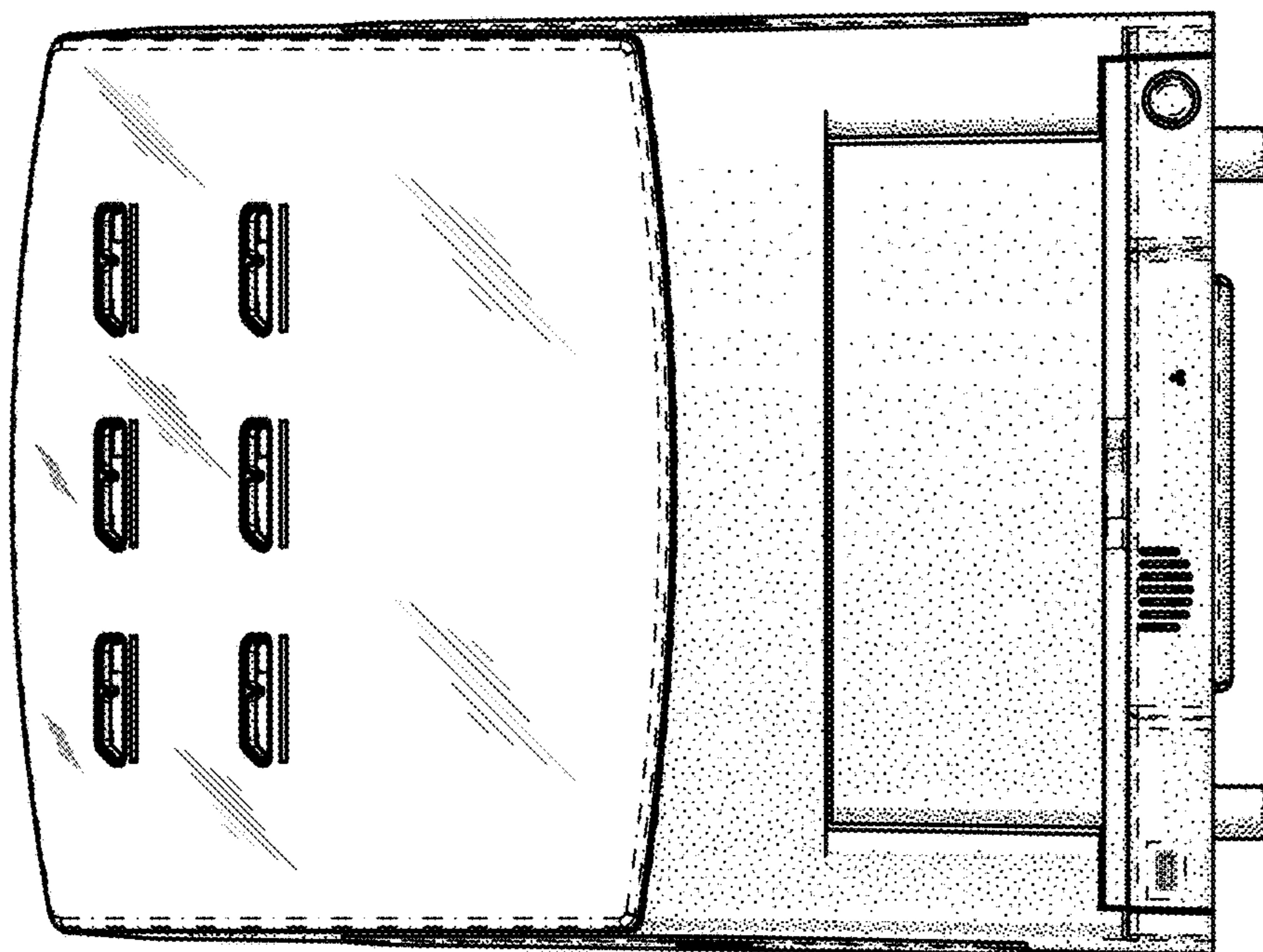

Figure 11



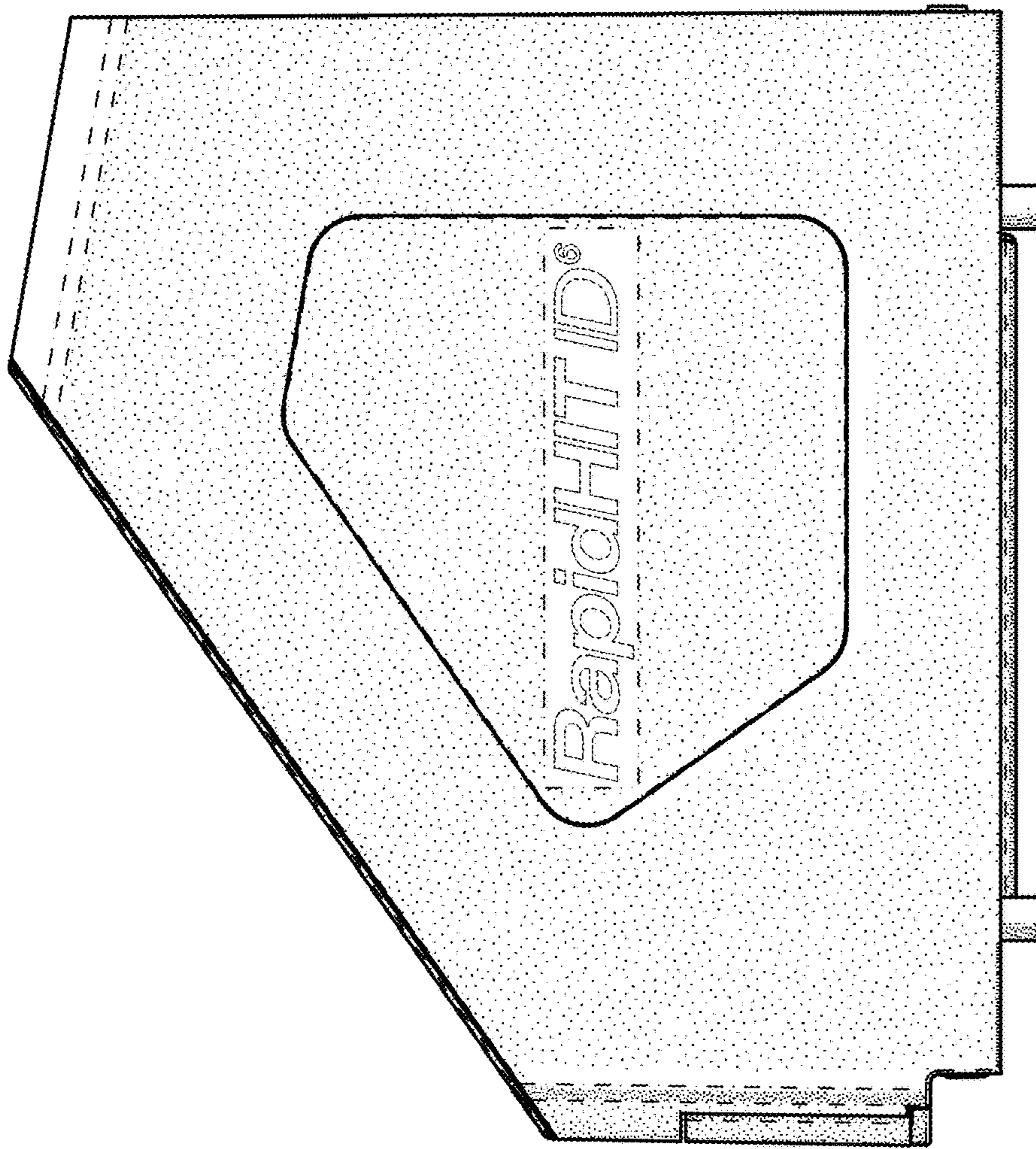

Figure 14

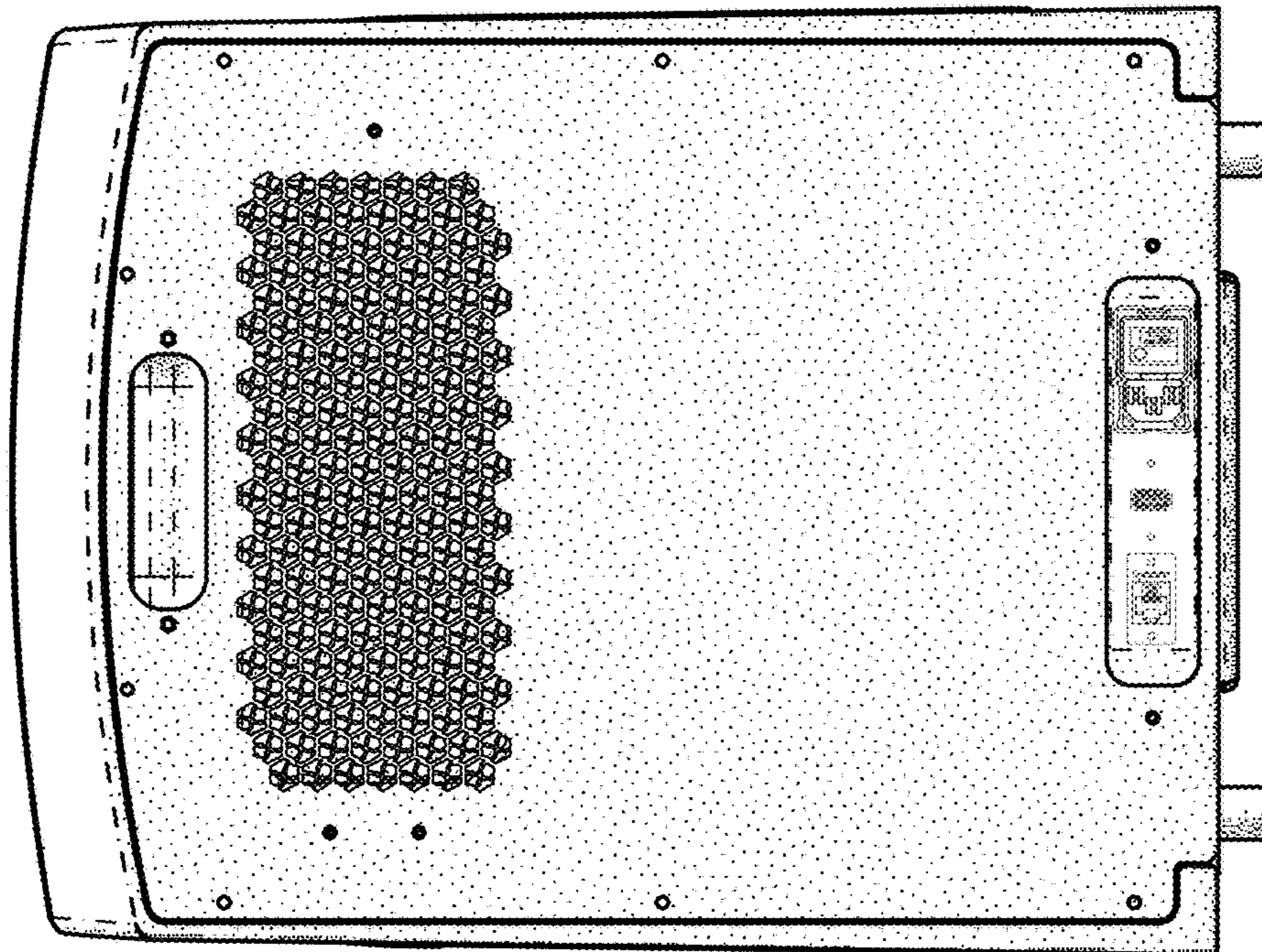

Figure 13

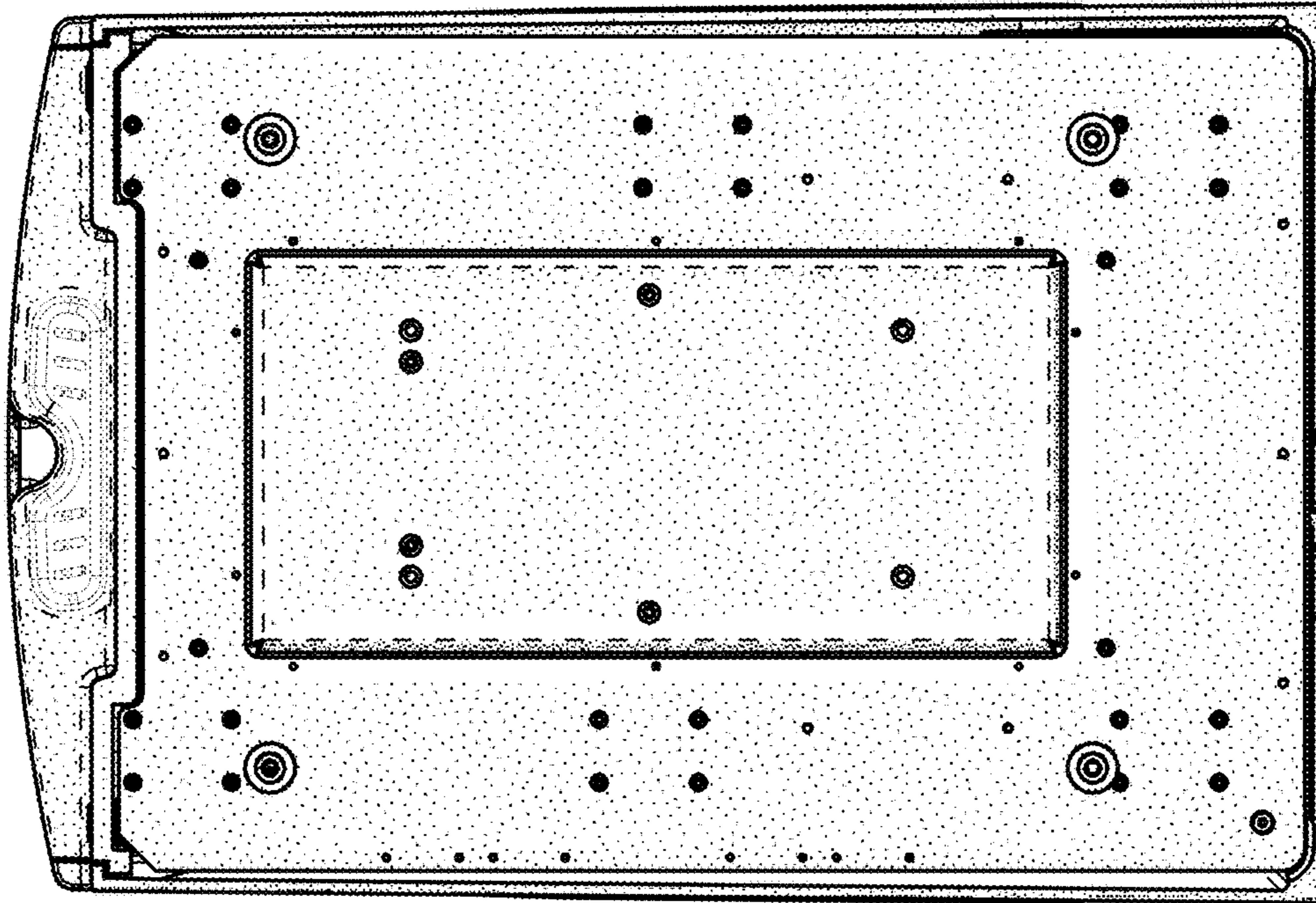

Figure 16

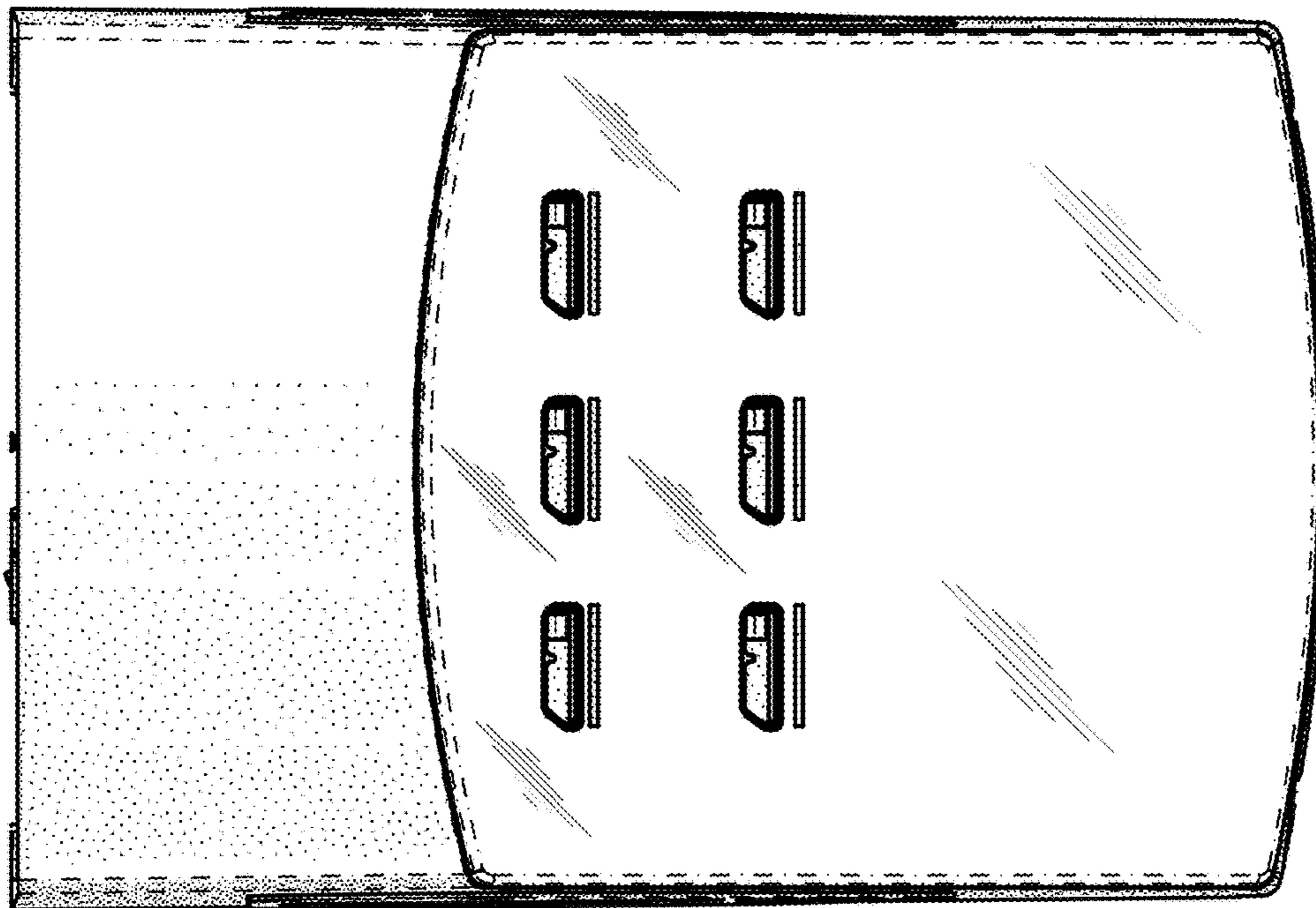

Figure 15



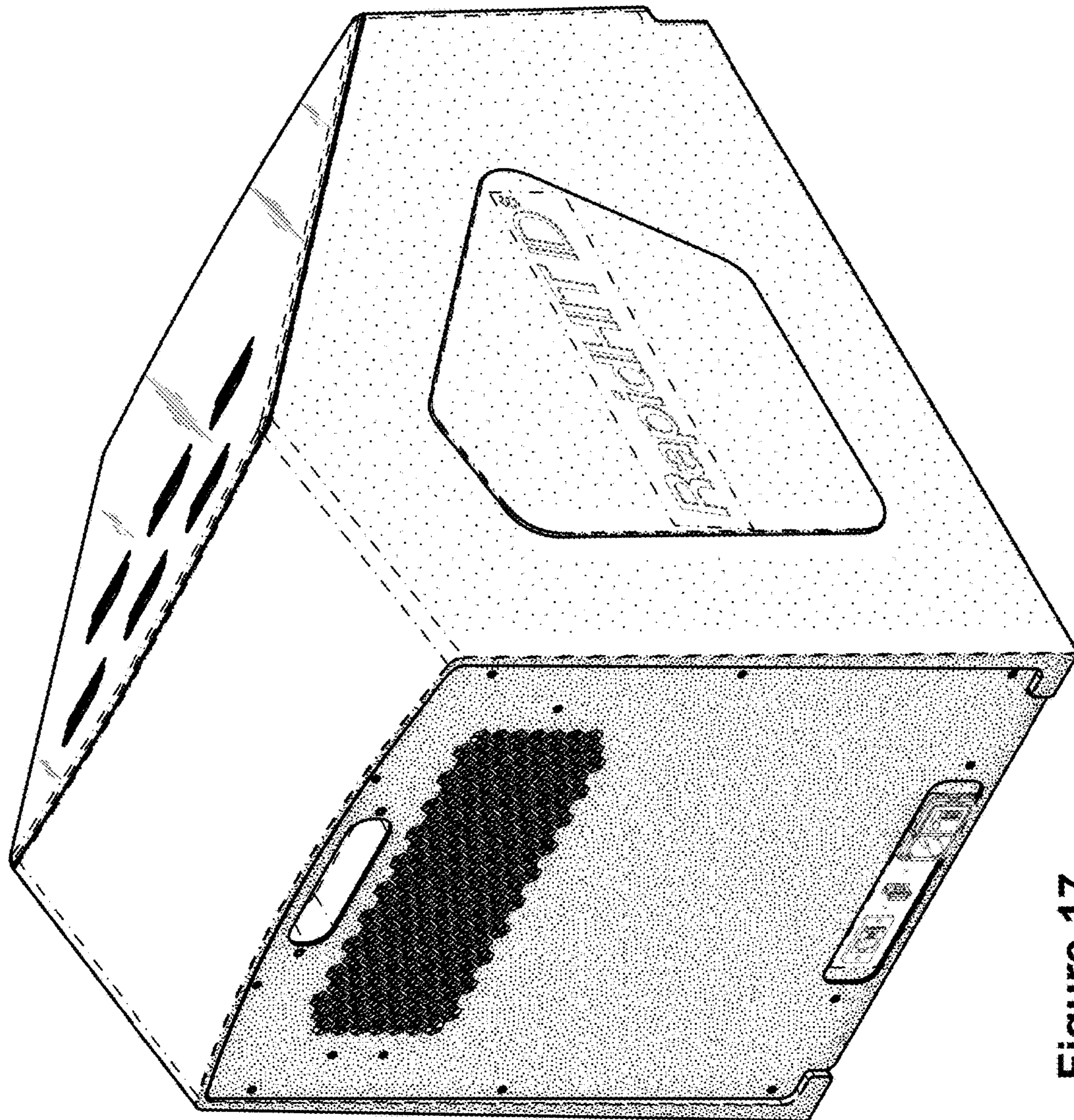

Figure 17

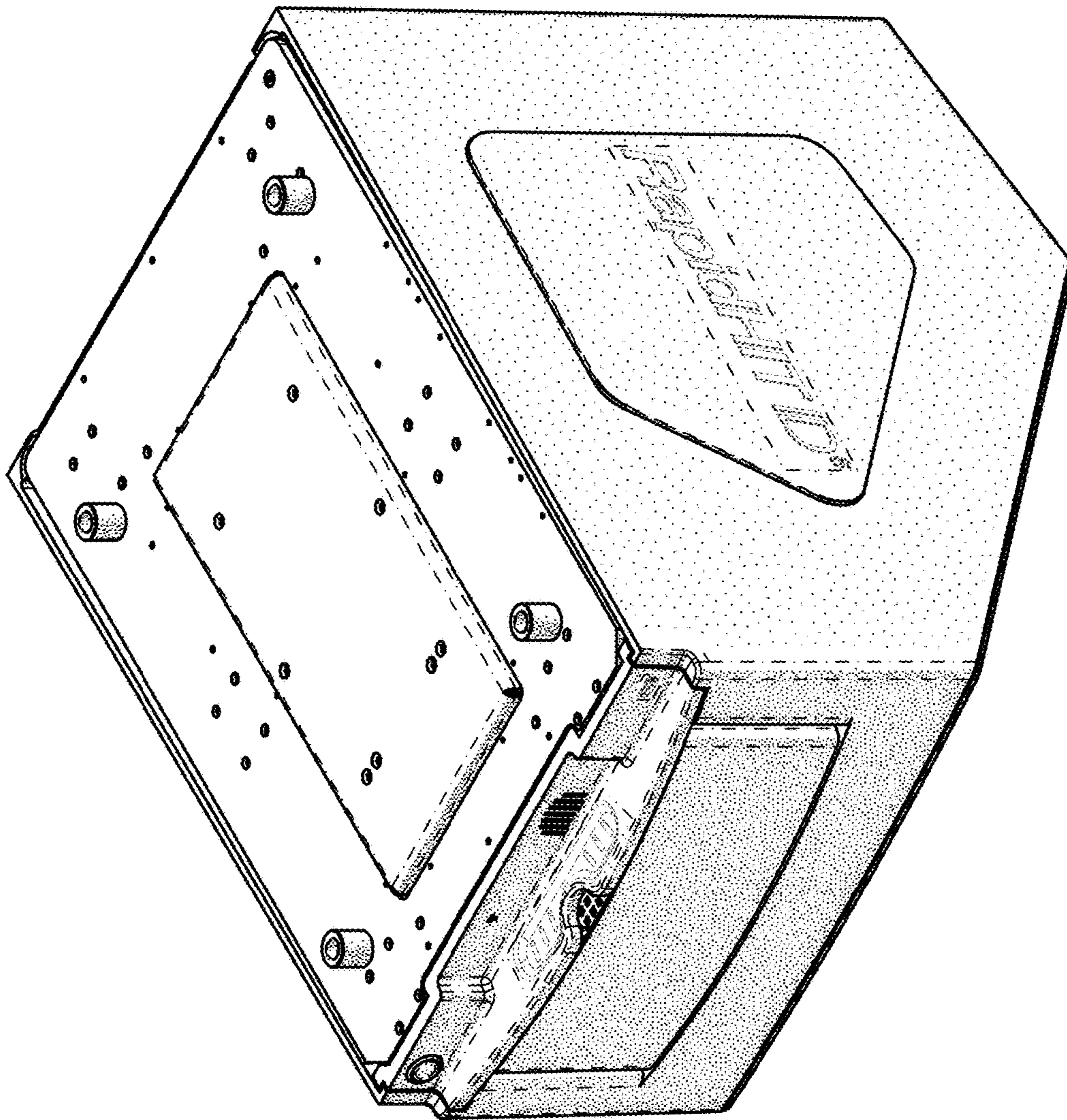

Figure 18



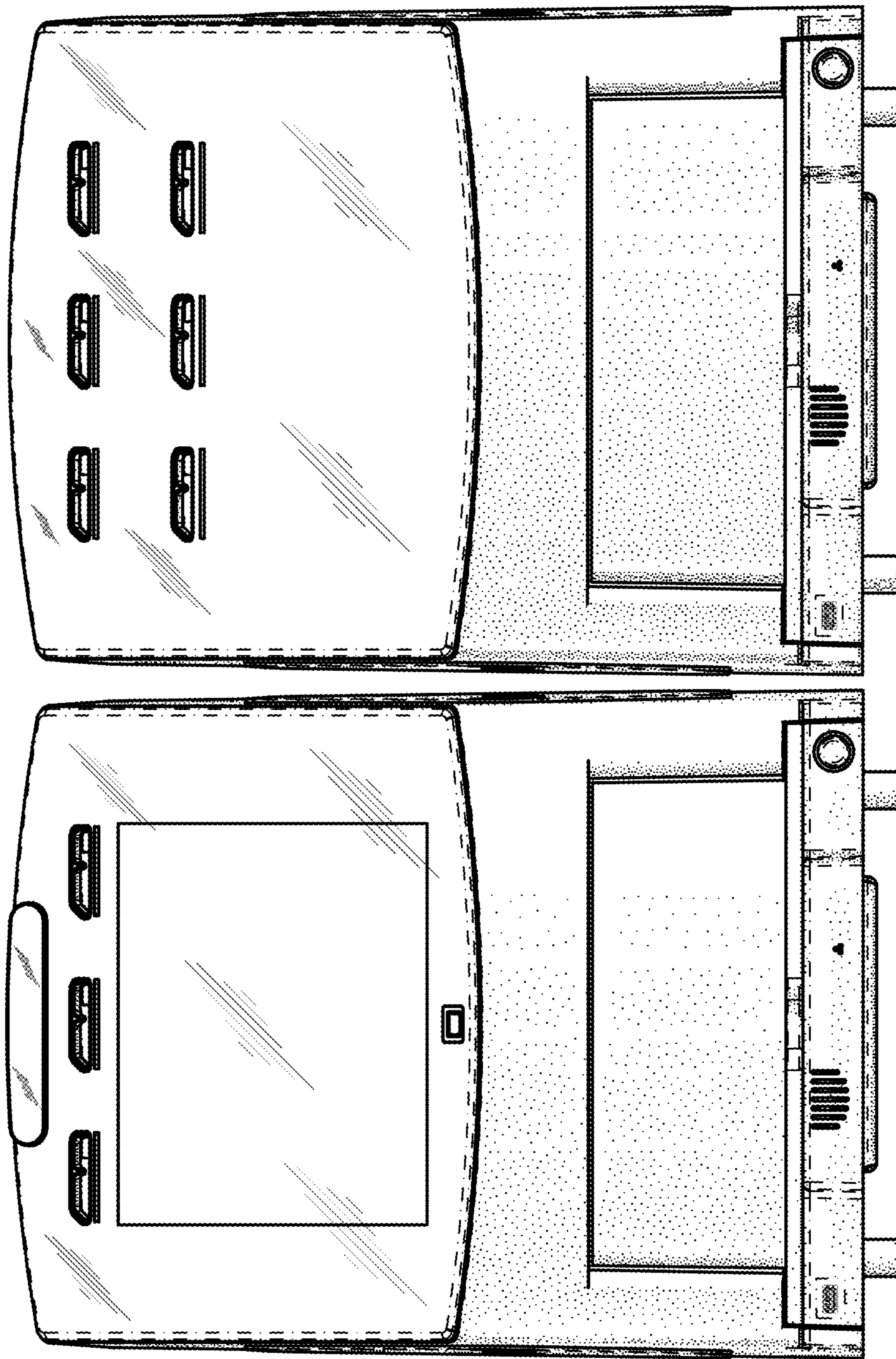

Figure 19