



US00D848872S

(12) **United States Design Patent** (10) **Patent No.:** **US D848,872 S**
Hummel (45) **Date of Patent:** **** May 21, 2019**

(54) **CARPENTERS SQUARE**
(71) Applicant: **Woodpeckers, LLC**, Strongsville, OH (US)
(72) Inventor: **Richard M. Hummel**, Parma, OH (US)
(73) Assignee: **Woodpeckers, LLC**, Strongsville, OH (US)
(**) Term: **15 Years**
(21) Appl. No.: **29/634,565**
(22) Filed: **Jan. 23, 2018**
(51) **LOC (11) Cl.** **10-04**
(52) **U.S. Cl.**
USPC **D10/65**
(58) **Field of Classification Search**
USPC D10/65
CPC B43L 7/027; B43L 7/0275; B43L 7/033
See application file for complete search history.

(56) **References Cited**
U.S. PATENT DOCUMENTS
563,465 A * 7/1896 Farley 33/476
4,562,649 A 1/1986 Ciavarella
4,729,173 A 3/1988 Wilson
D353,111 S * 12/1994 Meador D10/65
7,047,655 B2 5/2006 Larsson
8,191,275 B2 6/2012 Whitcomb

* cited by examiner
Primary Examiner — Antoine Duval Davis

(74) *Attorney, Agent, or Firm* — Sand, Sebolt & Wernow Co., LPA

(57) **CLAIM**
The ornamental design for a carpenters square, as shown and described.

DESCRIPTION
FIG. 1 is a top perspective view of a carpenters square showing my new design;
FIG. 2 is a front elevational view of FIG. 1;
FIG. 3 is a rear elevational view of FIG. 1;
FIG. 4 is a left side elevational view of FIG. 1;
FIG. 5 is a right side elevational view of FIG. 1;
FIG. 6 is a top plan view of FIG. 1;
FIG. 7 is a bottom plan view of FIG. 6;
FIG. 8 is an enlarged fragmentary sectional view taken on dash-dash line 8, FIG. 6;
FIG. 9 is an enlarged sectional view taken on dash-dash line 9, FIG. 6;
FIG. 10 is a top perspective view of a modified form of the carpenters square as shown in FIG. 1;
FIG. 11 is a front elevational view of FIG. 10;
FIG. 12 is a rear elevational view of FIG. 10;
FIG. 13 is a left side elevational view of FIG. 10;
FIG. 14 is a right side elevational view of FIG. 10;
FIG. 15 is a top plan view of FIG. 10;
FIG. 16 is a bottom plan view of FIG. 15;
FIG. 17 is an enlarged fragmentary sectional view taken on dash-dash line 17, FIG. 15; and,
FIG. 18 is an enlarged fragmentary sectional view taken on dash-dash line 18, FIG. 15.
The broken lines illustrate portions of the carpenters square which form no part of the claimed design.

1 Claim, 9 Drawing Sheets

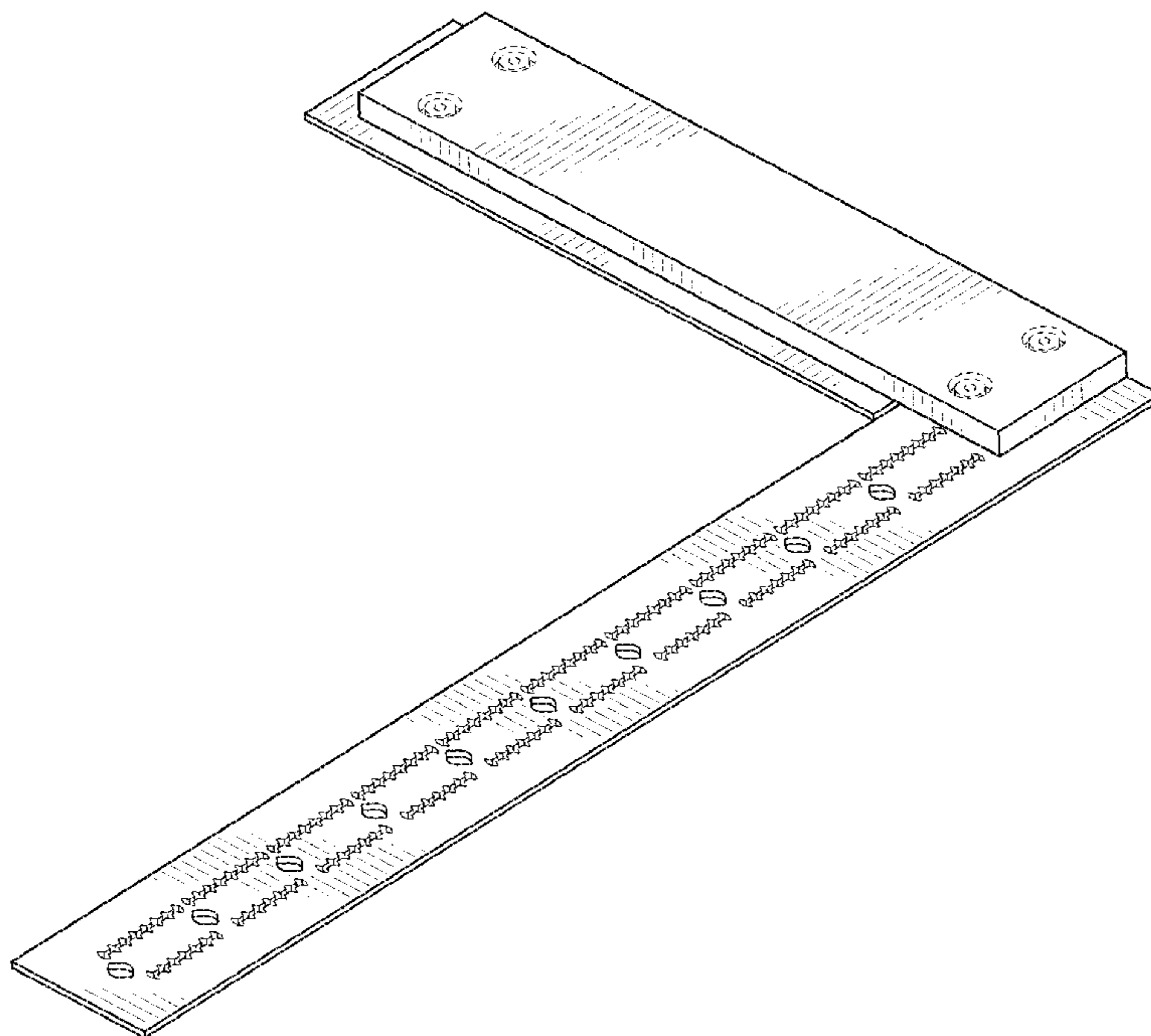

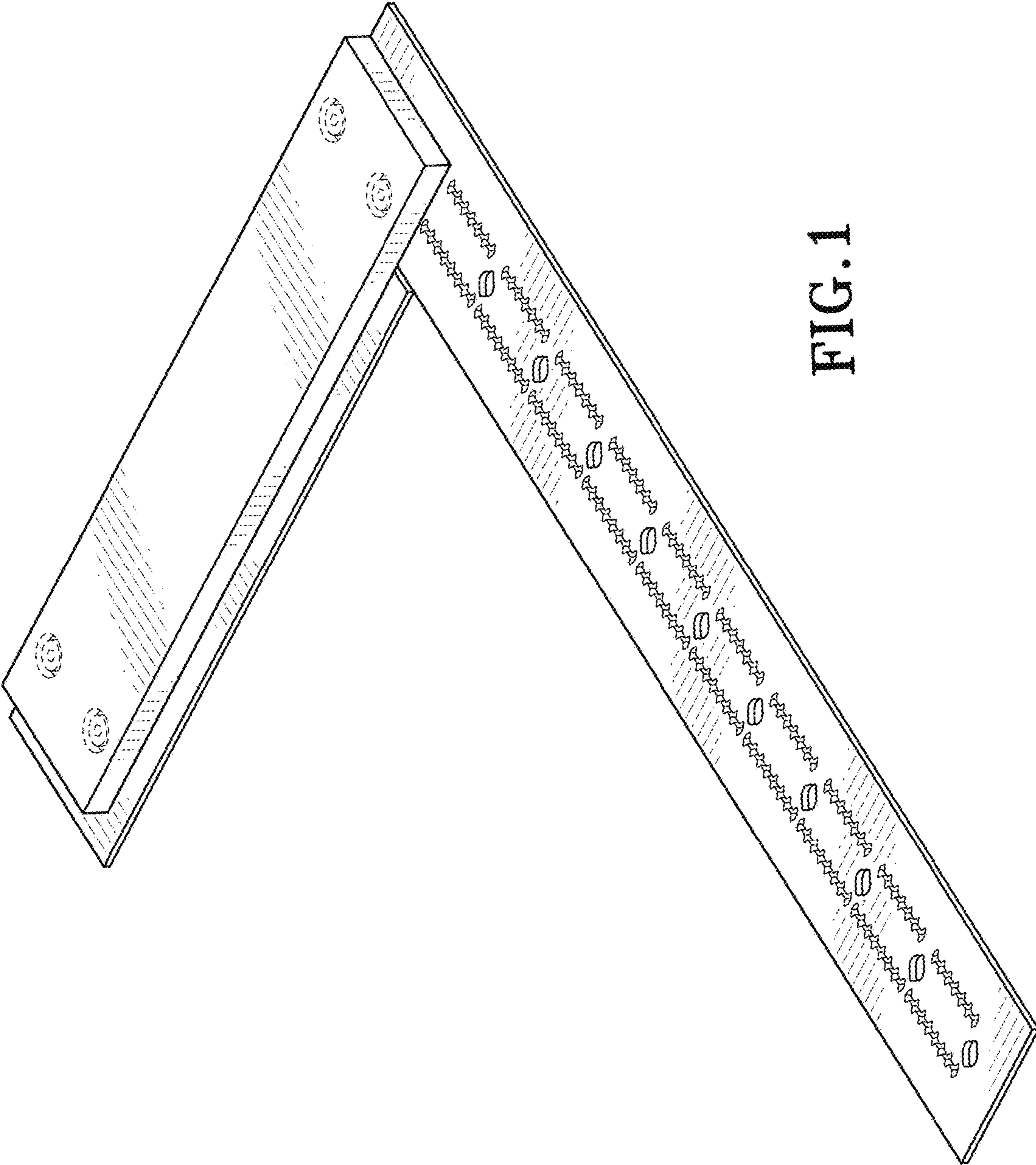

FIG. 1

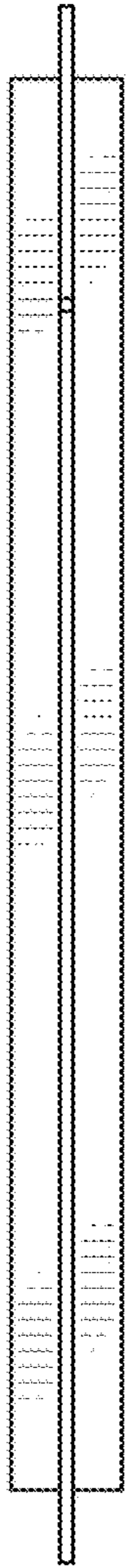

FIG. 2

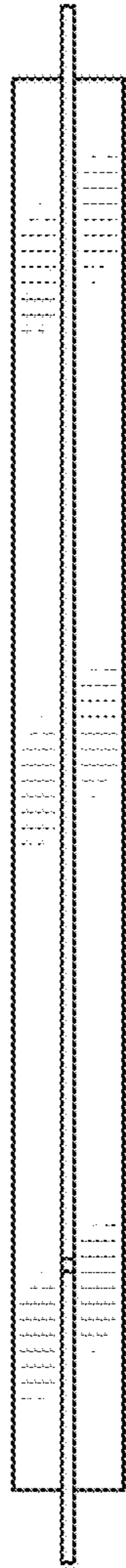

FIG. 3



FIG. 4



FIG. 5

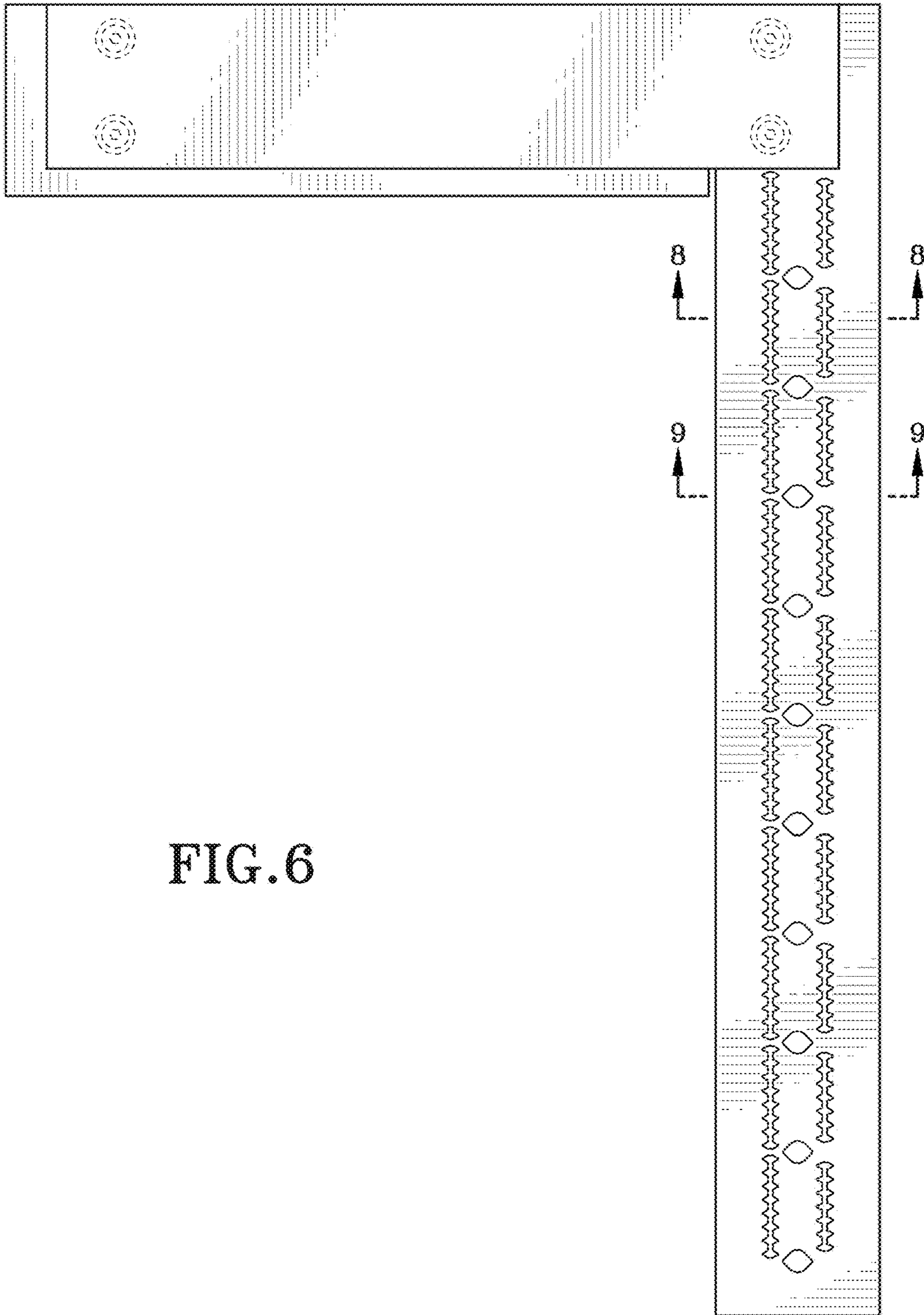
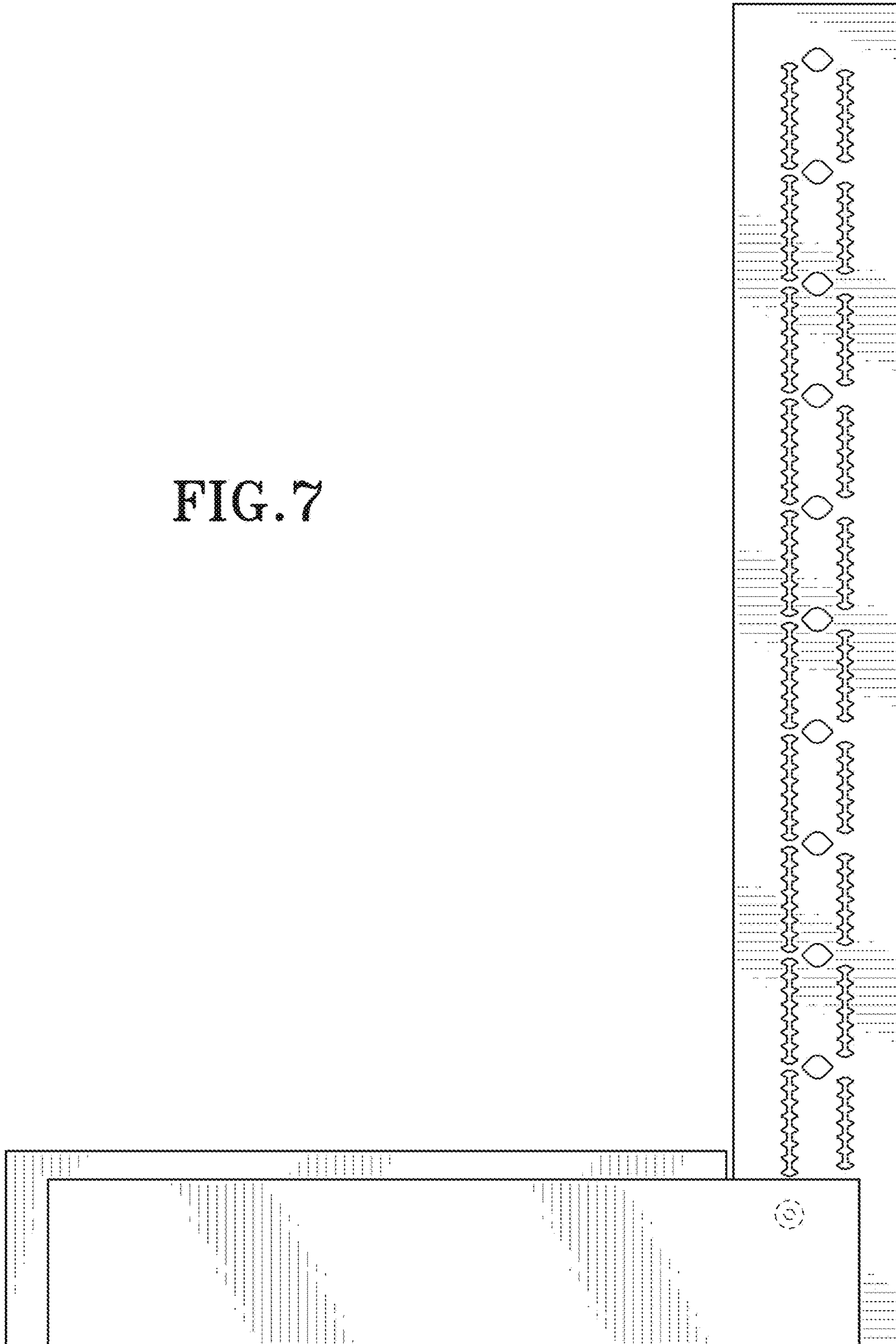

FIG.6

FIG. 7



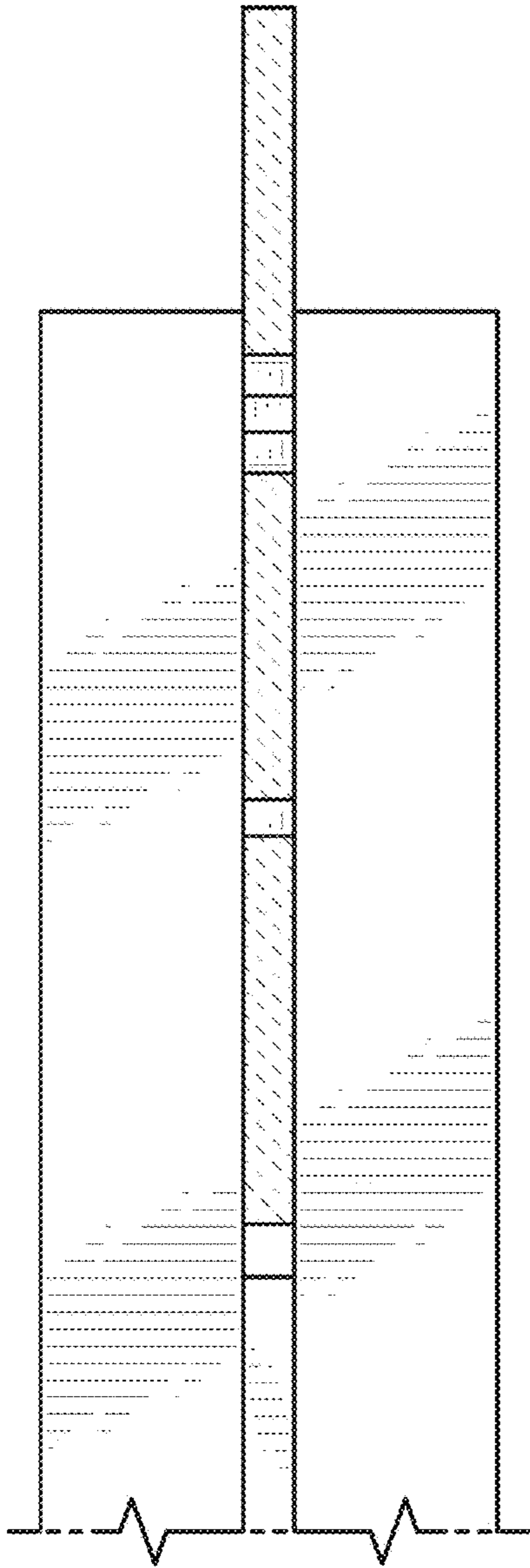

FIG. 8

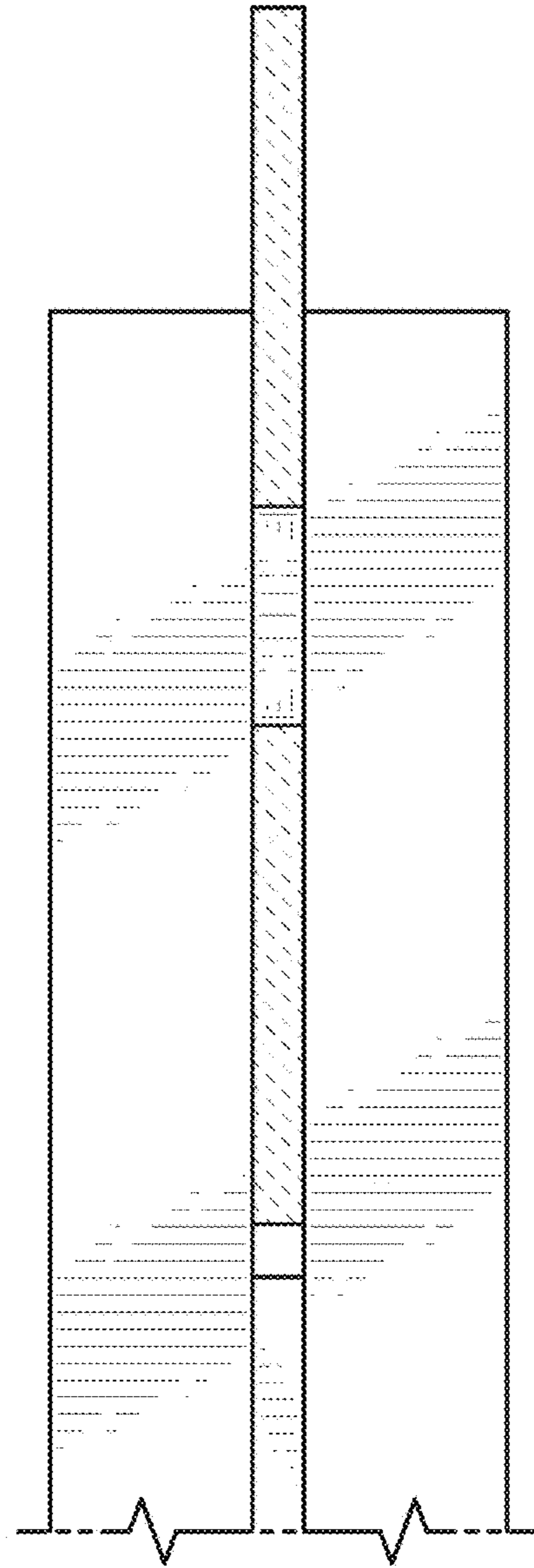

FIG. 9

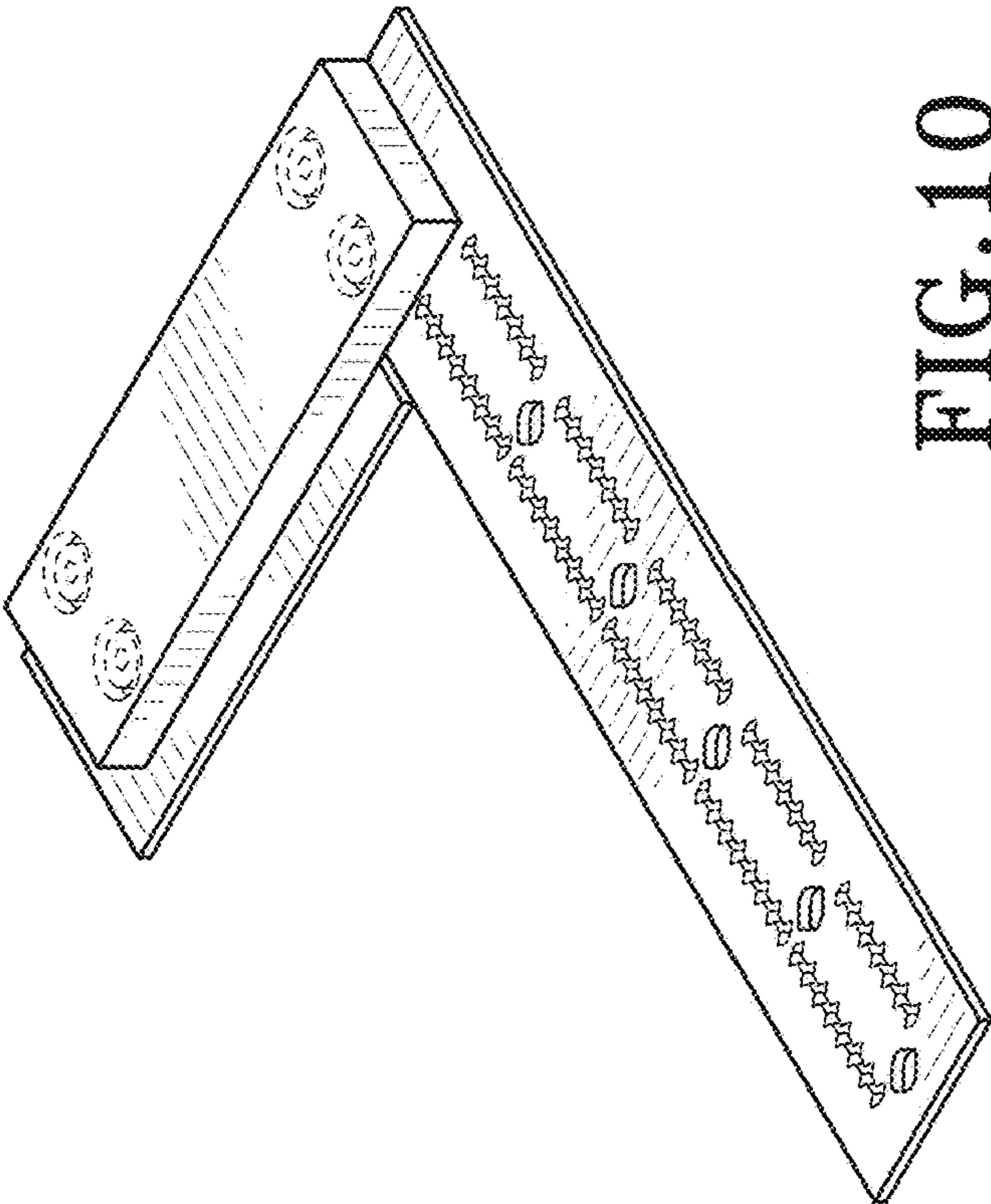

FIG. 10

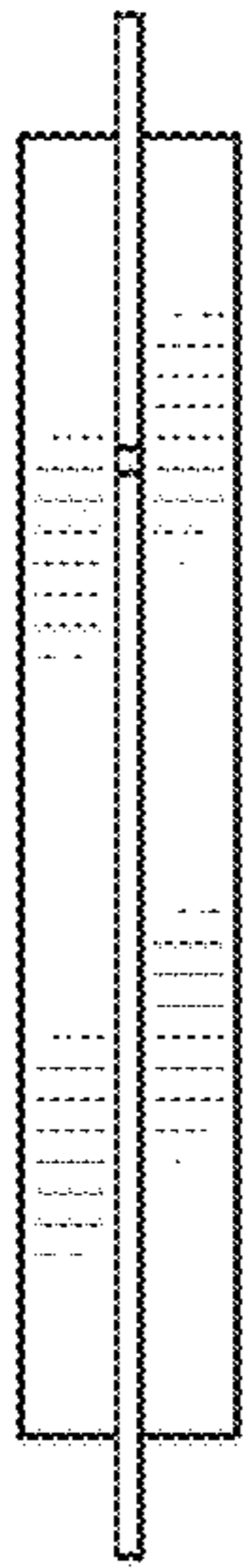

FIG. 11

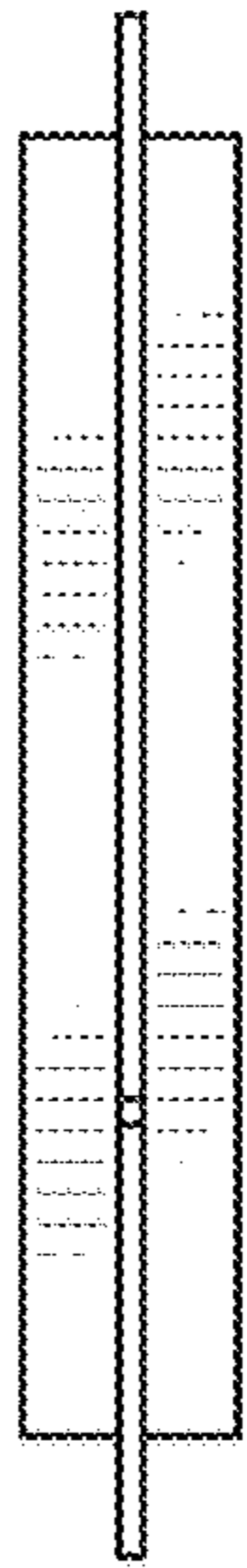

FIG. 12

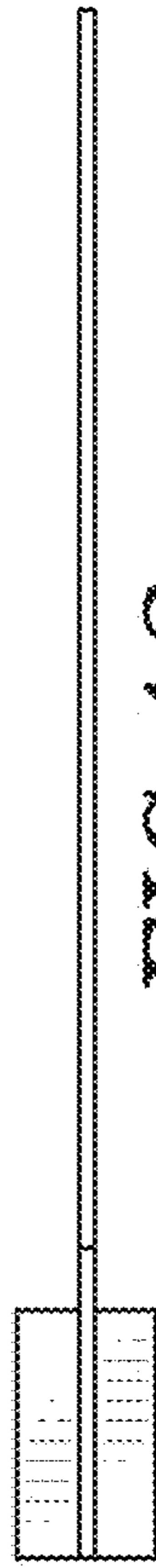
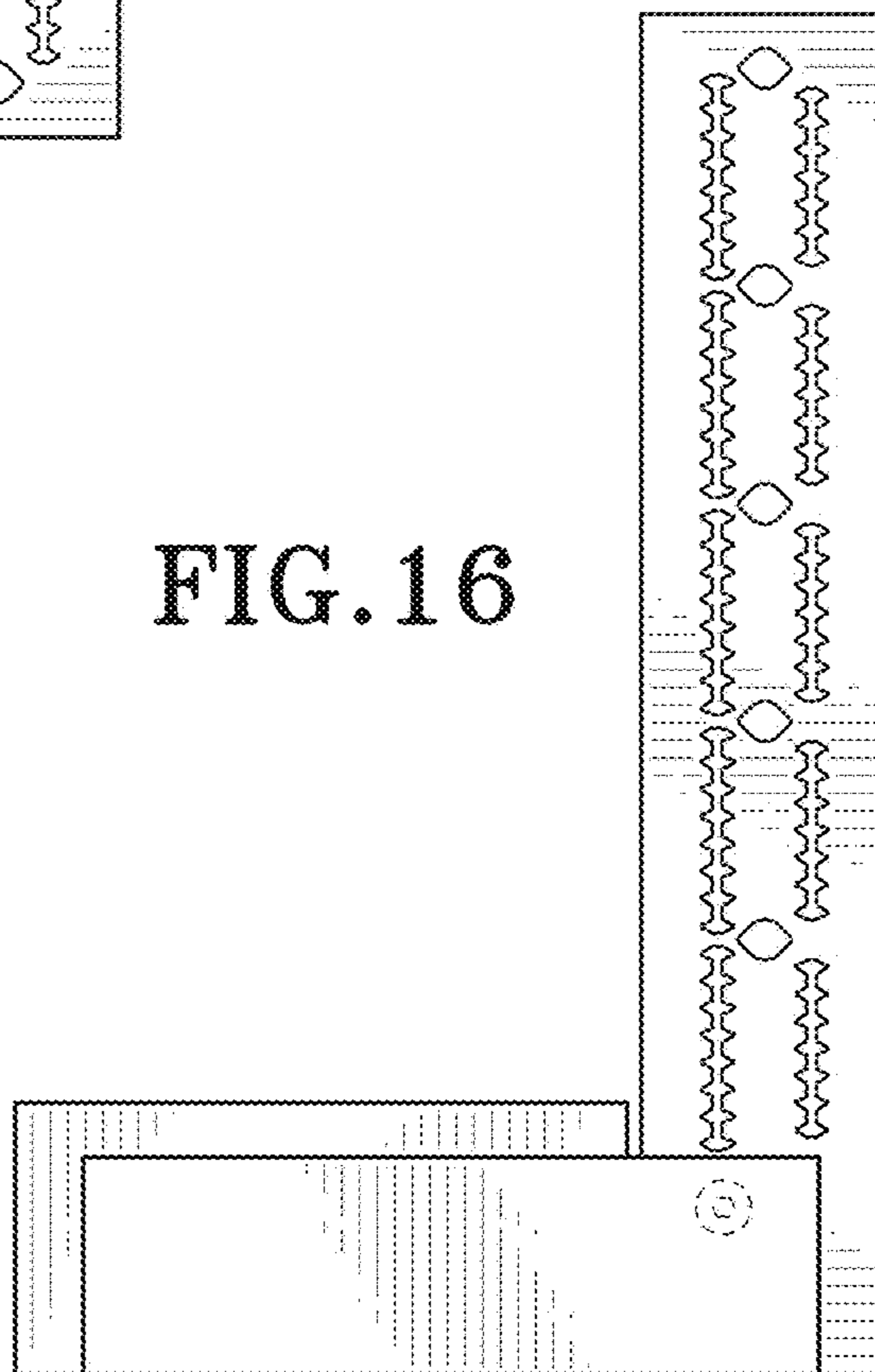
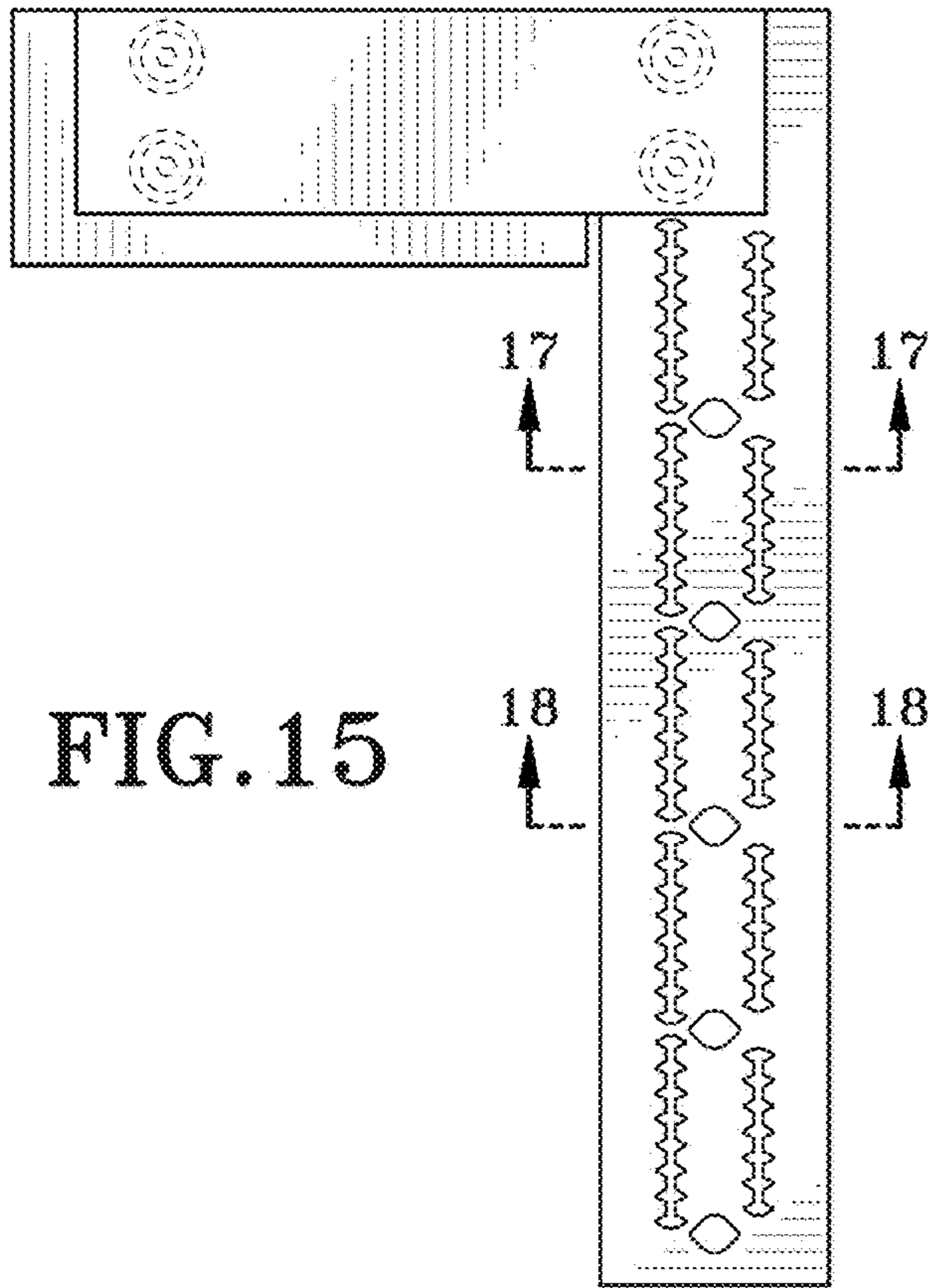

FIG. 13



FIG. 14



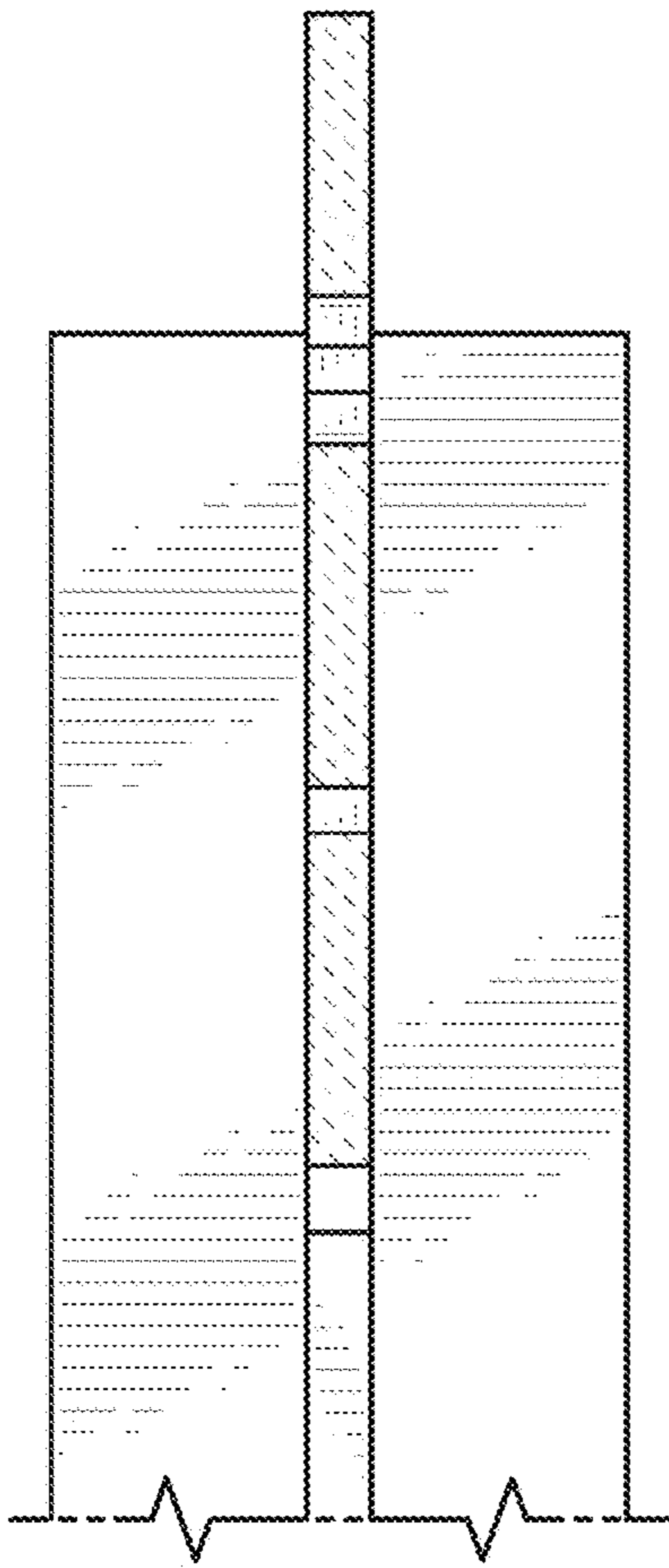

FIG. 17

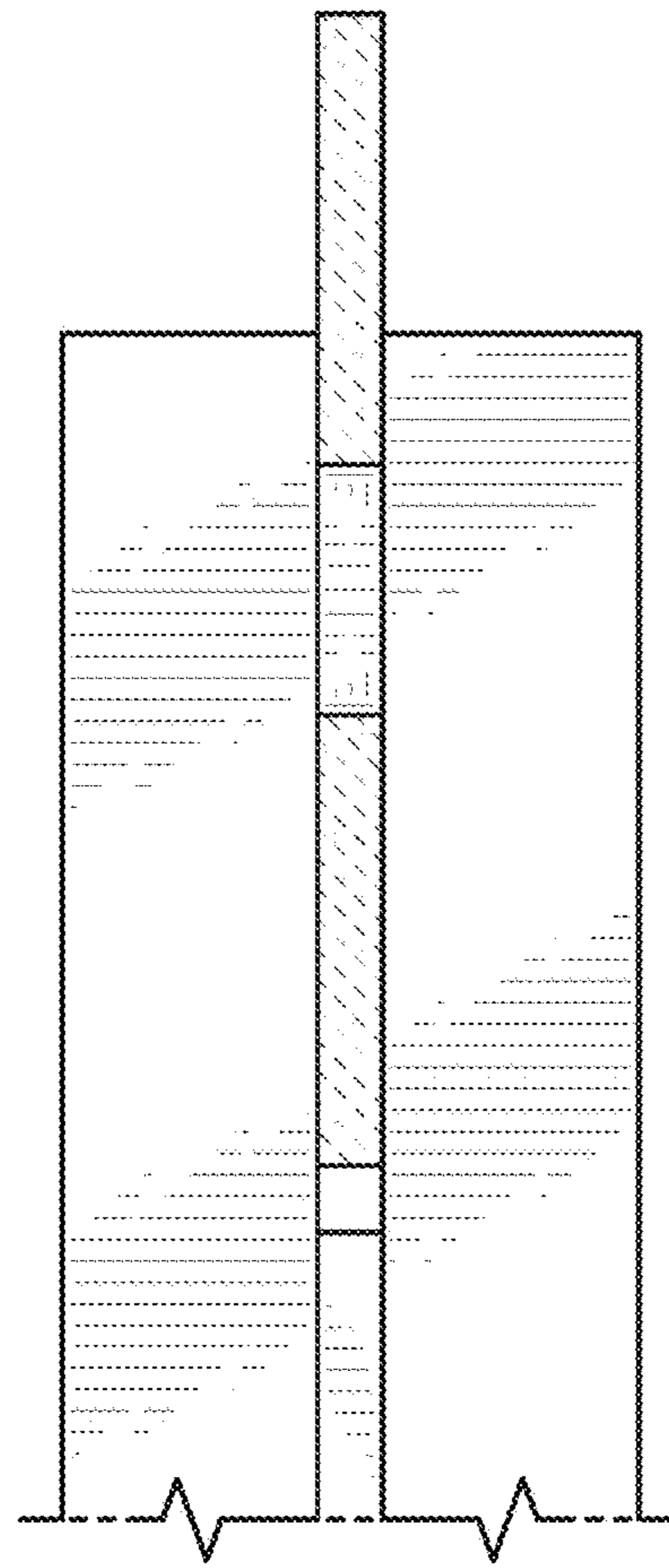

FIG. 18