



US00D848807S

(12) **United States Design Patent**
Chen

(10) **Patent No.: US D848,807 S**

(45) **Date of Patent: ** *May 21, 2019**

(54) **LONG REACH LOCKING PLIERS**

(71) Applicant: **JS Products, Inc.**, Las Vegas, NV (US)

(72) Inventor: **Chungeng Chen**, Las Vegas, NV (US)

(73) Assignee: **JS Products, Inc.**, Las Vegas, NV (US)

(*) Notice: This patent is subject to a terminal disclaimer.

(**) Term: **14 Years**

(21) Appl. No.: **29/508,977**

(22) Filed: **Nov. 12, 2014**

(51) **LOC (11) Cl.** **08-05**

(52) **U.S. Cl.**
USPC **D8/52**

(58) **Field of Classification Search**
USPC D8/4, 5, 14, 51-58, 105, 107

(Continued)

(56) **References Cited**

U.S. PATENT DOCUMENTS

D298,008 S * 10/1988 Kim D8/52
5,385,072 A * 1/1995 Neff B25B 7/04
81/356

(Continued)

Primary Examiner — Deanna L Pratt

(74) *Attorney, Agent, or Firm* — Weide & Miller, Ltd.

(57) **CLAIM**

The ornamental design for long reach locking pliers, as shown and described.

DESCRIPTION

FIG. 1 is a right side view of a first embodiment of a tool;

FIG. 2 is a bottom right perspective view of the first embodiment of the tool;

FIG. 3 is a back right perspective view of the first embodiment of the tool;

FIG. 4 is a left side view of the first embodiment of the tool;

FIG. 5 is a back left perspective view of the first embodiment of the tool;

FIG. 6 is a top view of the first embodiment of the tool;

FIG. 7 is a bottom view of the first embodiment of the tool;

FIG. 8 is a back view of the first embodiment of the tool;

FIG. 9 is a right side view of a second embodiment of the tool;

FIG. 10 is a top right perspective view of the second embodiment of the tool;

FIG. 11 is a back right perspective view of the second embodiment of the tool;

FIG. 12 is a left side view of the second embodiment of the tool;

FIG. 13 is a back left perspective view of the second embodiment of the tool;

FIG. 14 is a top view of the second embodiment of the tool;

FIG. 15 is a bottom view of the second embodiment of the tool;

FIG. 16 is a back view of the second embodiment of the tool;

FIG. 17 is a right side view of a third embodiment of the tool;

FIG. 18 is a top right perspective view of the third embodiment of the tool;

FIG. 19 is a back right perspective view of the third embodiment of the tool;

FIG. 20 is a left side view of the third embodiment of the tool;

FIG. 21 is a back left perspective view of the third embodiment of the tool;

FIG. 22 is a top view of the third embodiment of the tool;

FIG. 23 is a bottom view of the third embodiment of the tool; and,
FIG. 24 is a back view of the third embodiment of the tool.

1 Claim, 24 Drawing Sheets

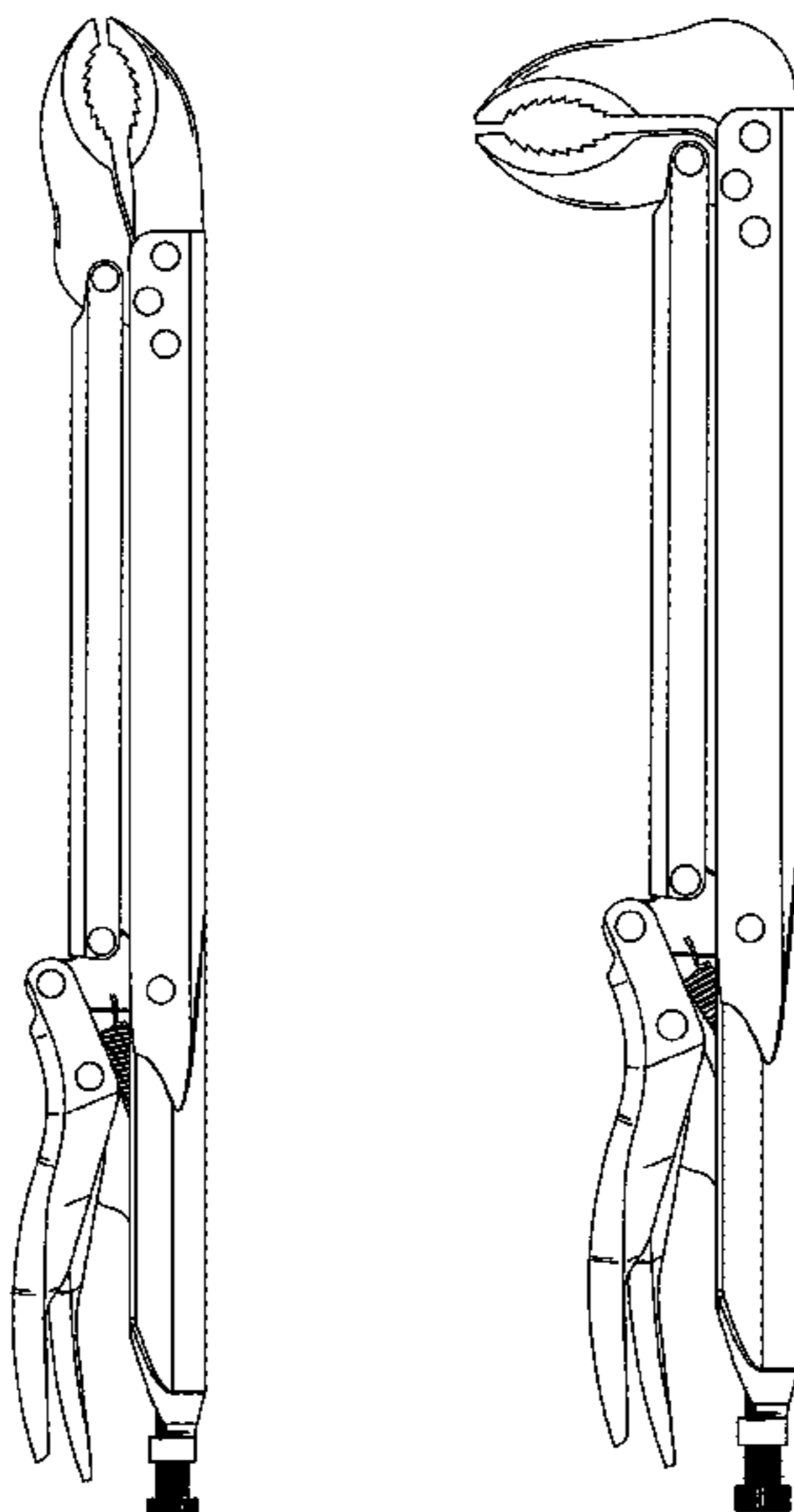

(58) **Field of Classification Search**

CPC .. B27B 7/123; B27B 7/10; B27B 7/12; B27B
7/02; B27B 7/00

See application file for complete search history.

(56) **References Cited**

U.S. PATENT DOCUMENTS

5,435,214	A	*	7/1995	Sisson	B25B 7/123
					294/104
D397,603	S	*	9/1998	Eggert	D8/107
D470,373	S	*	2/2003	Ferreria	D8/52
D543,815	S	*	6/2007	Metcalf	D8/52
D599,637	S	*	9/2009	Valencia	D8/52
D653,092	S	*	1/2012	Carra	D8/52

* cited by examiner

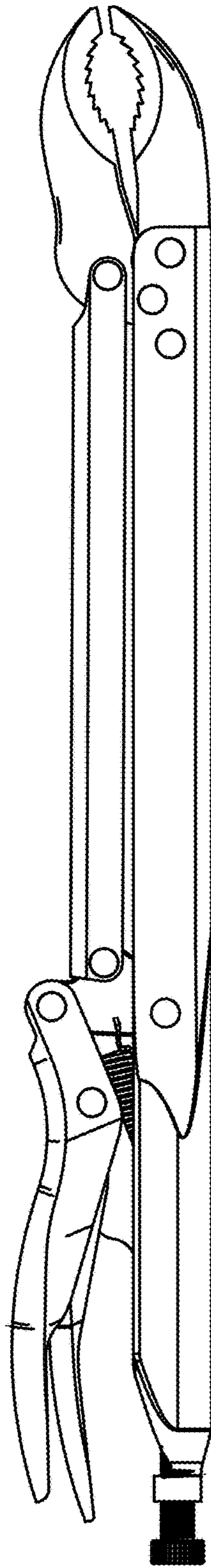

FIG. 1

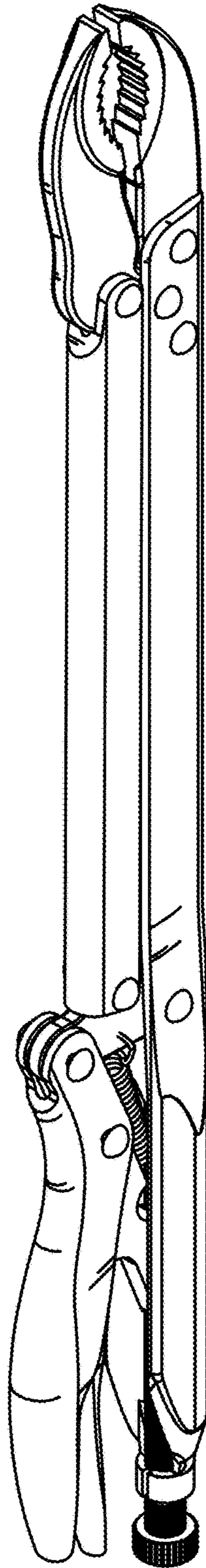

FIG. 2

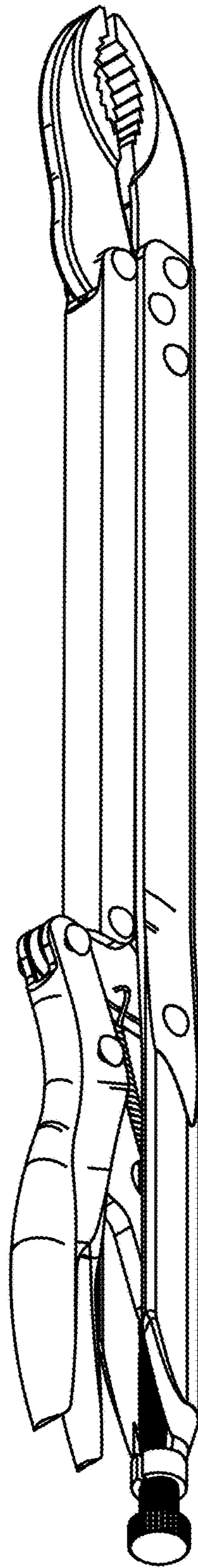

FIG. 3

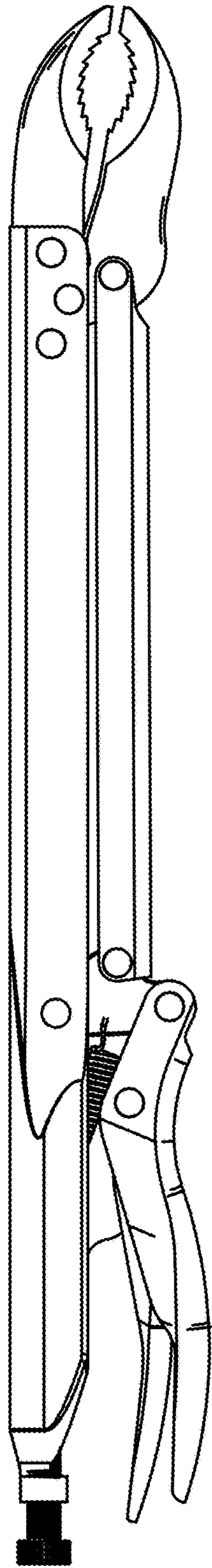

FIG. 4

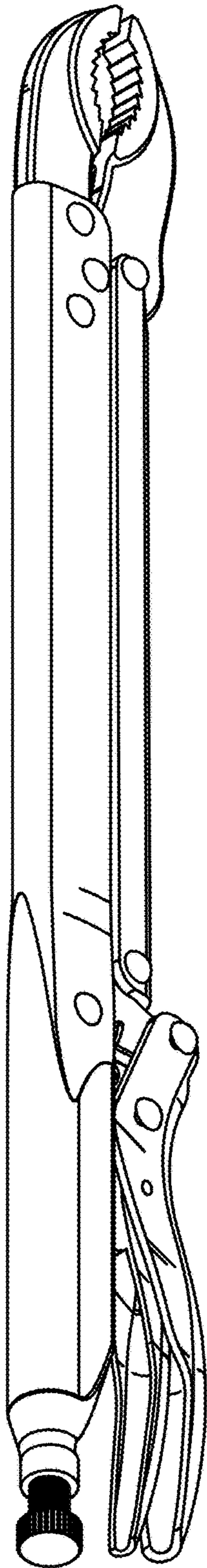

FIG. 5

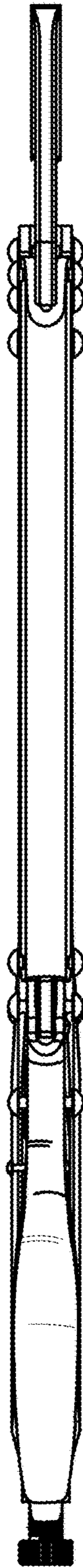

FIG. 6

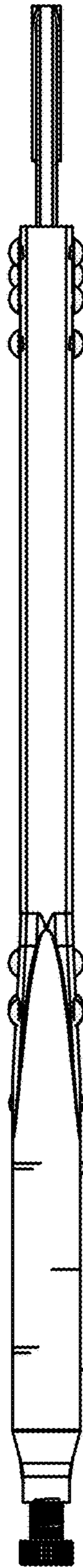

FIG. 7

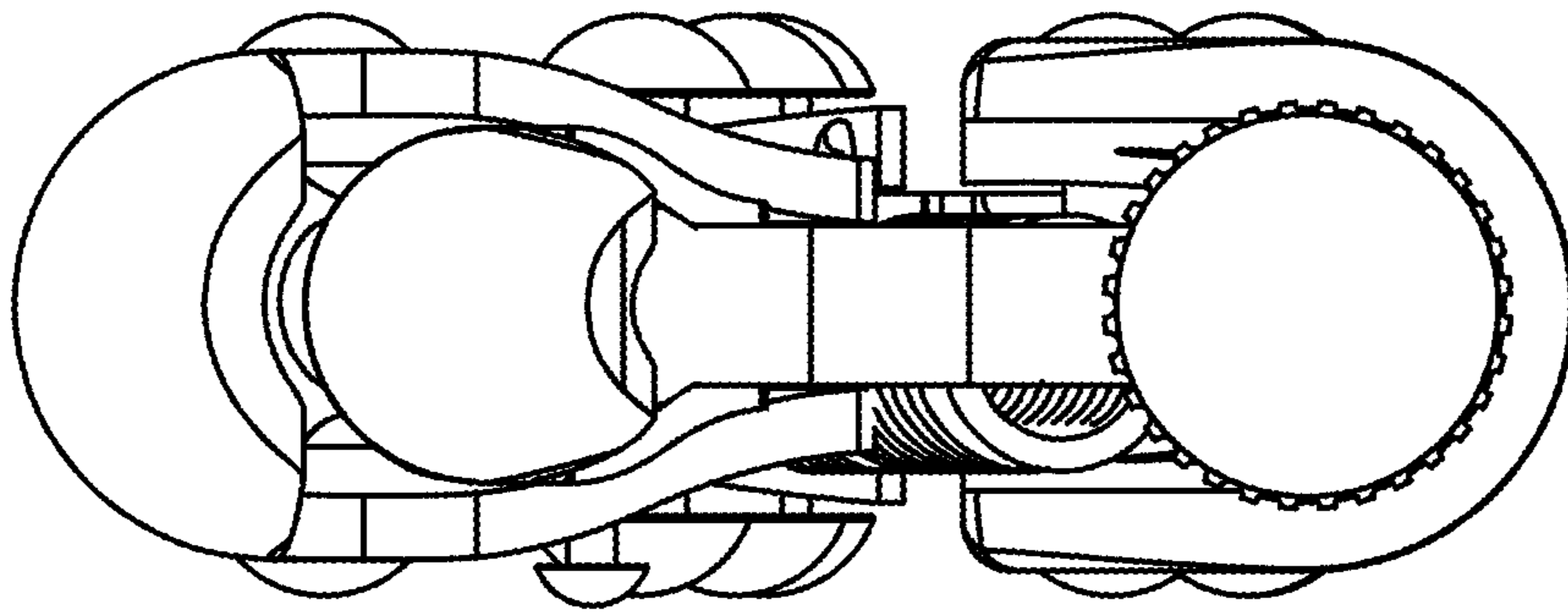

FIG. 8

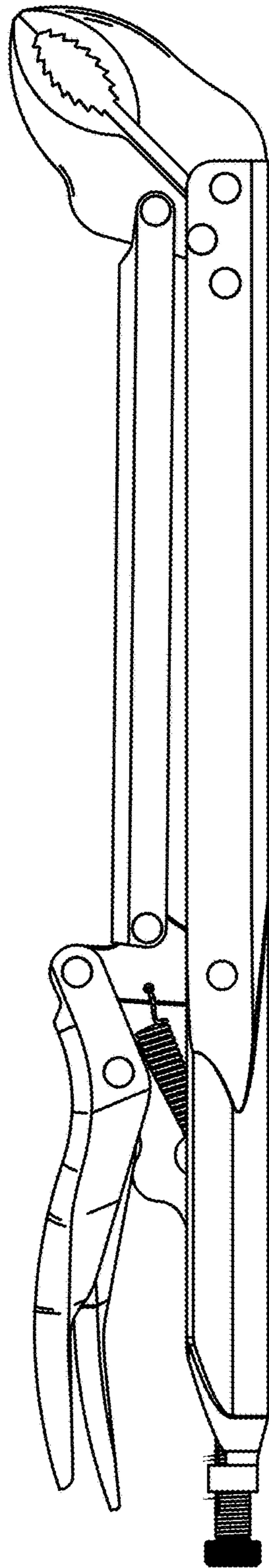

FIG. 9

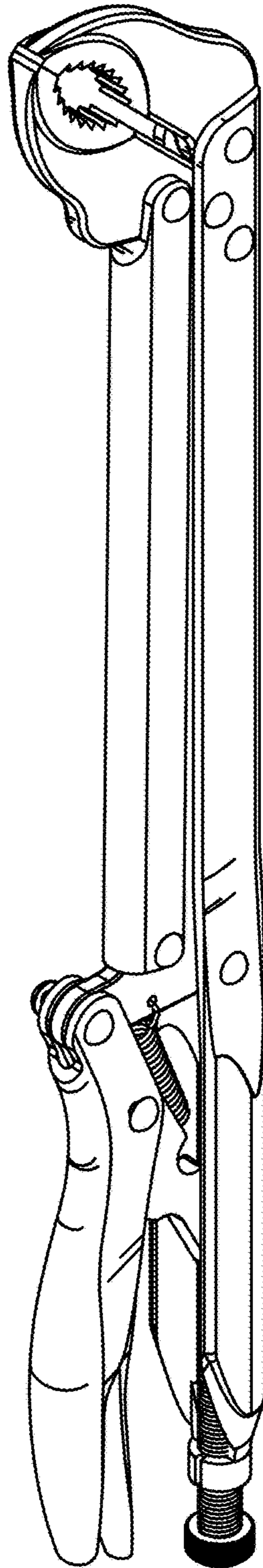

FIG. 10

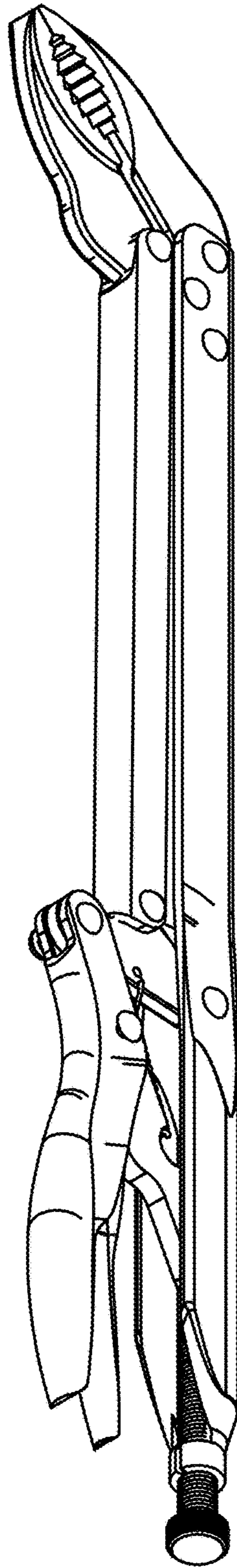

FIG. 11

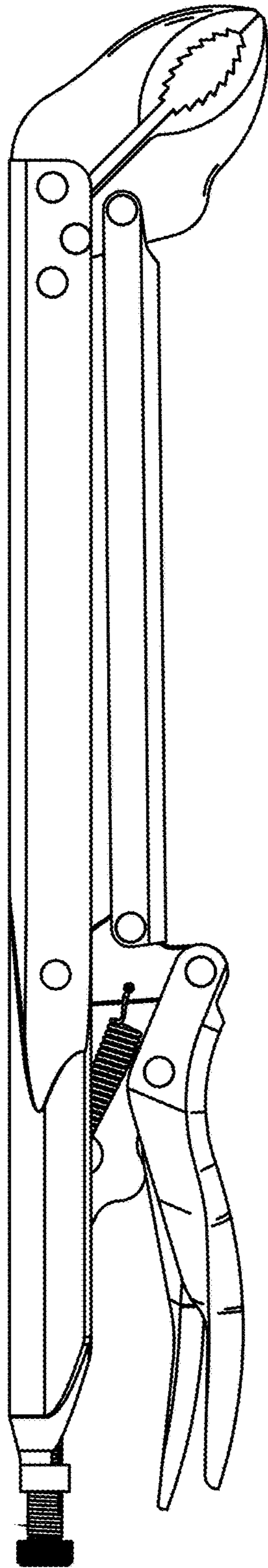

FIG. 12

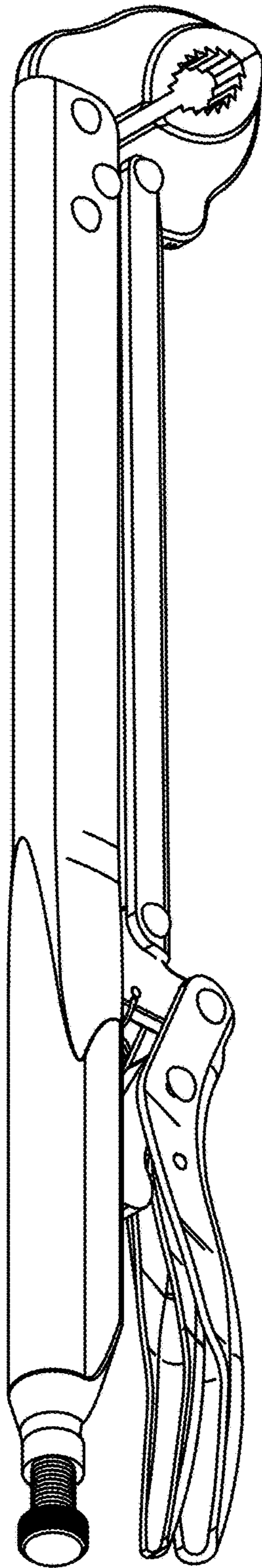

FIG. 13

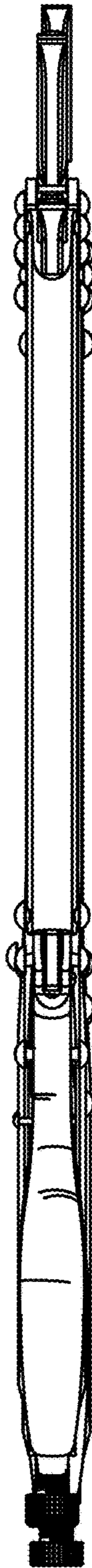

FIG. 14

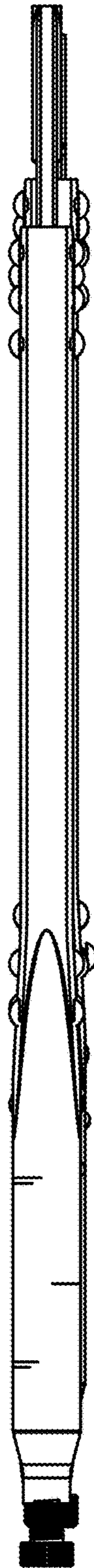

FIG. 15

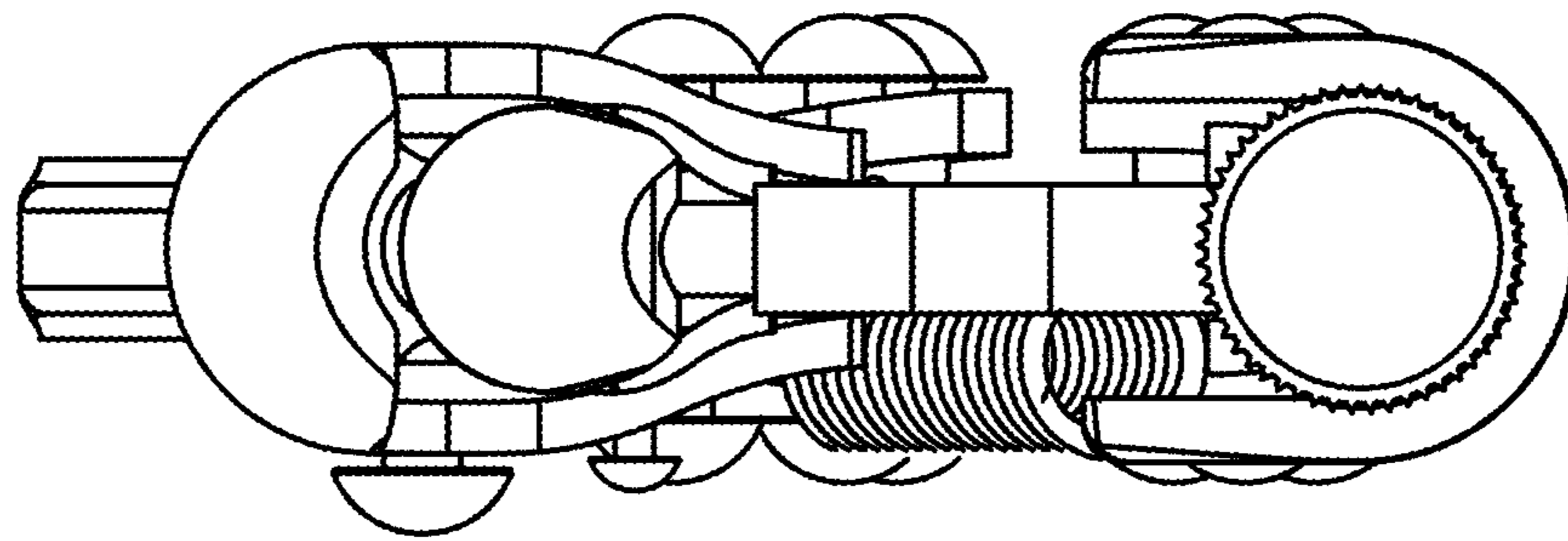

FIG. 16

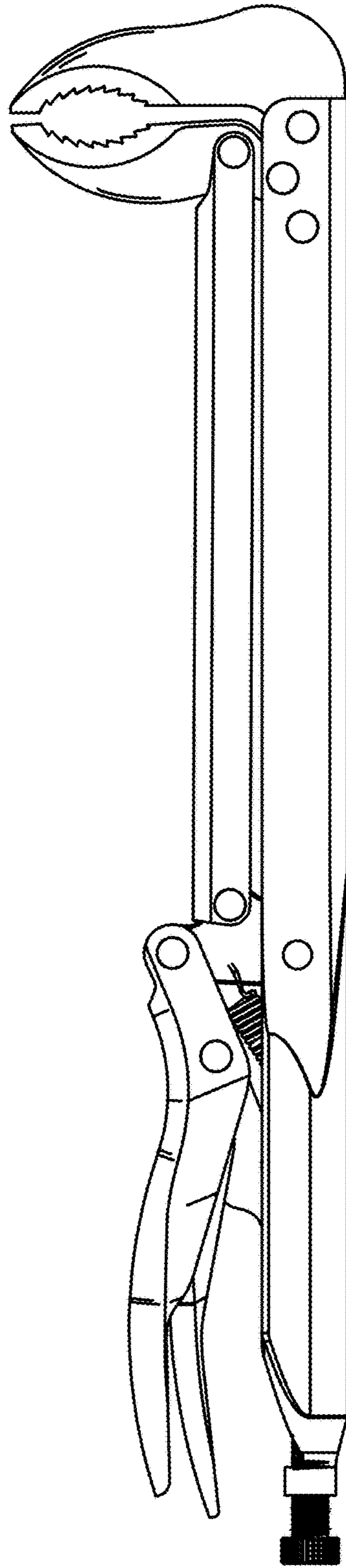

FIG. 17



FIG. 18

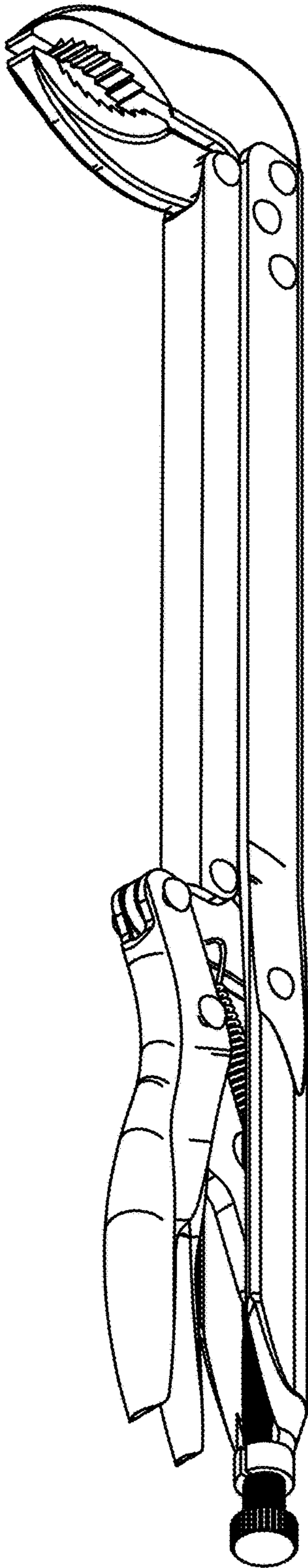

FIG. 19

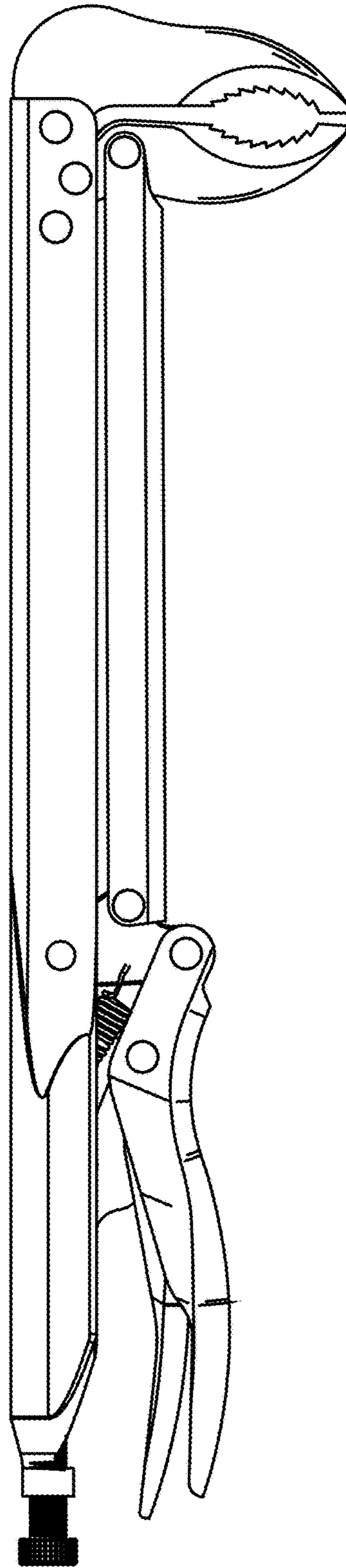

FIG. 20

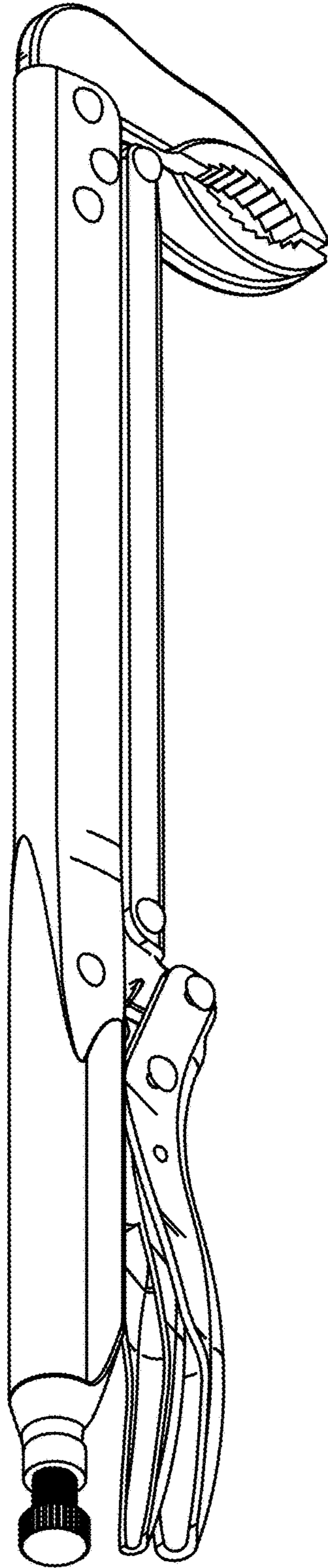

FIG. 21

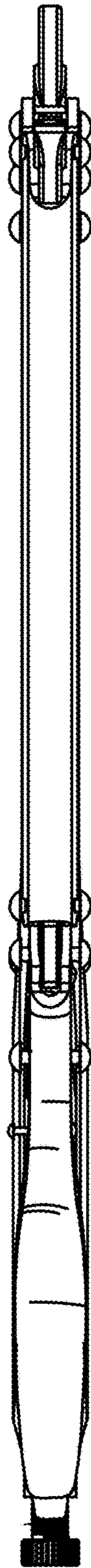

FIG. 22

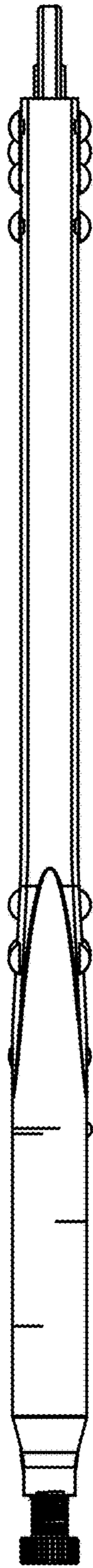

FIG. 23

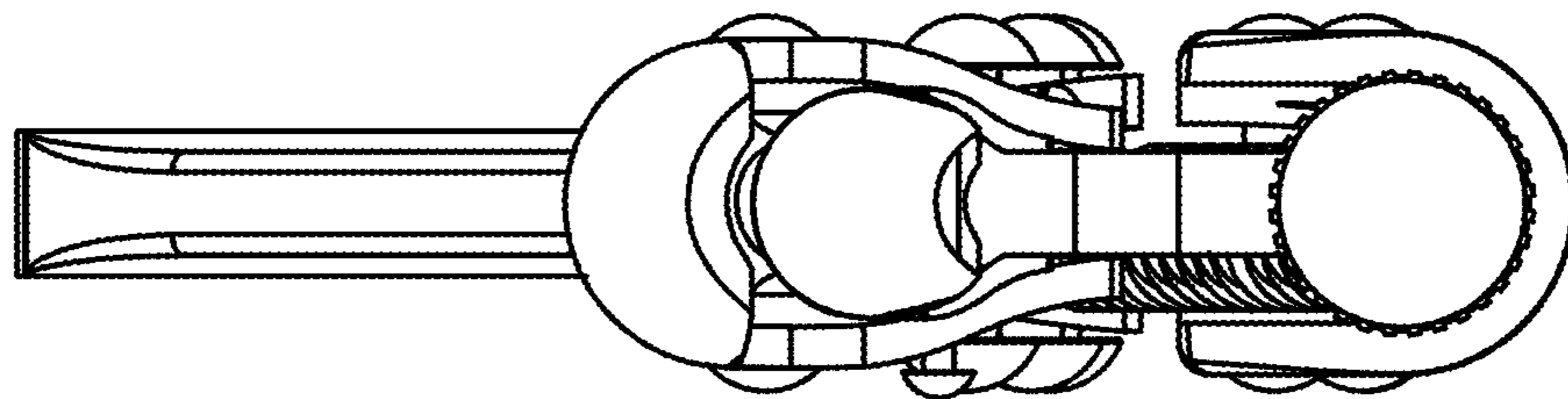

FIG. 24