



US00D848792S

(12) **United States Design Patent**
Duvigneau

(10) **Patent No.:** **US D848,792 S**

(45) **Date of Patent:** **** May 21, 2019**

(54) **BOTTLE**

(71) Applicant: **CURVER Luxembourg Sarl,**
Neidercorn (LU)

(72) Inventor: **Nikolai Duvigneau, Zichron Yaacov**
(IL)

(73) Assignee: **CURVER LUXEMBOURG SARL,**
Neidercorn (LU)

(**) Term: **15 Years**

(21) Appl. No.: **29/613,181**

(22) Filed: **Aug. 8, 2017**

(30) **Foreign Application Priority Data**

Feb. 9, 2017 (IL) 59942

(51) **LOC (11) Cl.** **07-01**

(52) **U.S. Cl.**
USPC **D7/510; D7/511; D7/523; D7/532;**
D7/624.2

(58) **Field of Classification Search**
USPC **D7/507, 509, 510, 511, 523, 529, 531,**
D7/532, 533, 536, 392.1, 396.2, 300.2,
D7/608, 387, 589, 624.2; D9/500, 501,
D9/502, 503, 530, 516, 453, 447;
220/592.16, 592.17; D10/46.2
CPC **A47G 19/2205; A47G 19/22; A47G**
19/2266; B65D 47/066; A45F 3/16; A47J
41/02

See application file for complete search history.

(56) **References Cited**

U.S. PATENT DOCUMENTS

D456,672 S * 5/2002 Bodum D7/510
D492,597 S * 7/2004 Norris D9/442
D513,931 S * 1/2006 Liu D7/511
D547,184 S * 7/2007 Kim D9/447

D575,580 S * 8/2008 Germany D7/392.1
D615,816 S * 5/2010 Joy D7/507
D621,259 S * 8/2010 Joy D9/444
D629,259 S * 12/2010 Joy D7/607
D644,072 S * 8/2011 McDonald D7/667
D700,806 S * 3/2014 Joy D7/507
8,668,106 B1 * 3/2014 Joy A47G 19/2266
220/254.3

(Continued)

Primary Examiner — Marianne N Pandozzi

Assistant Examiner — Jae Liang

(74) *Attorney, Agent, or Firm* — Dorsey & Whitney LLP

(57) **CLAIM**

The ornamental design for a bottle, as shown and described.

DESCRIPTION

FIG. 1 is a front view of a first embodiment of a bottle, in a closed position, showing my new design;
FIG. 2 is a rear view thereof;
FIG. 3 is a left side view thereof; the right side view being a mirror image;
FIG. 4 is a top view thereof; and
FIG. 5 is a bottom view thereof;
FIG. 6 is a top perspective view thereof;
FIG. 7 is a top perspective view of the bottle shown in FIG. 1, in an opened position;
FIG. 8 is a front view of a second embodiment of a bottle, in a closed position;
FIG. 9 is a rear view thereof;
FIG. 10 is a left side view thereof; the right side view being a mirror image;
FIG. 11 is a top view thereof;
FIG. 12 is a bottom view thereof;
FIG. 13 is a top perspective view thereof; and,
FIG. 14 is a top perspective view of the bottle shown in FIG. 8 in an opened position.

The broken lines in the drawings depict portions of the bottle that form no part of the claimed design.

1 Claim, 14 Drawing Sheets

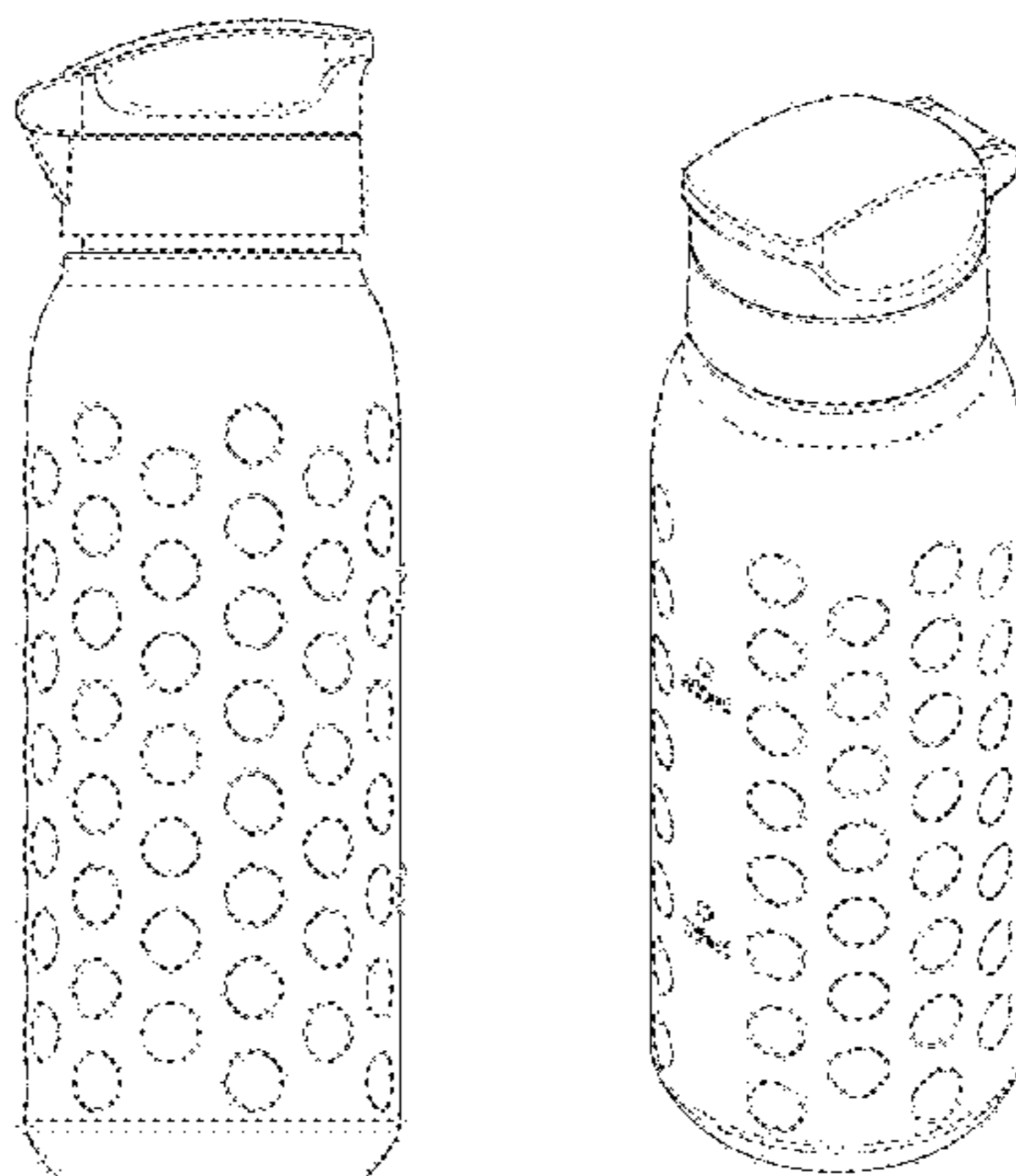

(56)

References Cited

U.S. PATENT DOCUMENTS

D707,087	S *	6/2014	Joy	D7/607
D722,828	S *	2/2015	Shamoon	D7/510
D751,923	S *	3/2016	Wofford	D9/773
D761,623	S *	7/2016	Leimone	D7/507
D763,622	S *	8/2016	Shirley	D7/511
D772,021	S *	11/2016	Joy	D7/624.1
D772,656	S *	11/2016	Joy	D7/624.1
D777,514	S *	1/2017	McMullin	D7/400
D781,113	S *	3/2017	Kocsis	D7/624.2
D783,369	S *	4/2017	Matsuo	D7/608
D795,011	S *	8/2017	Pisarevsky	D7/507
D797,516	S *	9/2017	Meyers	D7/589
D812,428	S *	3/2018	Wu	D7/510
D814,241	S *	4/2018	Nickley	D7/510
D815,901	S *	4/2018	Steinmann	D7/510
D817,088	S *	5/2018	Shirley	D7/396.2
D819,403	S *	6/2018	Li	D7/510
D821,146	S *	6/2018	Steinmann	D7/510
2009/0057257	A1 *	3/2009	Marcus	A61J 9/08 215/11.6
2013/0306630	A1 *	11/2013	Babinsky	B65D 81/3869 220/62.12
2013/0319966	A1 *	12/2013	Lane	B65D 43/26 215/237
2014/0263324	A1 *	9/2014	Latham	B65D 51/18 220/259.1

* cited by examiner

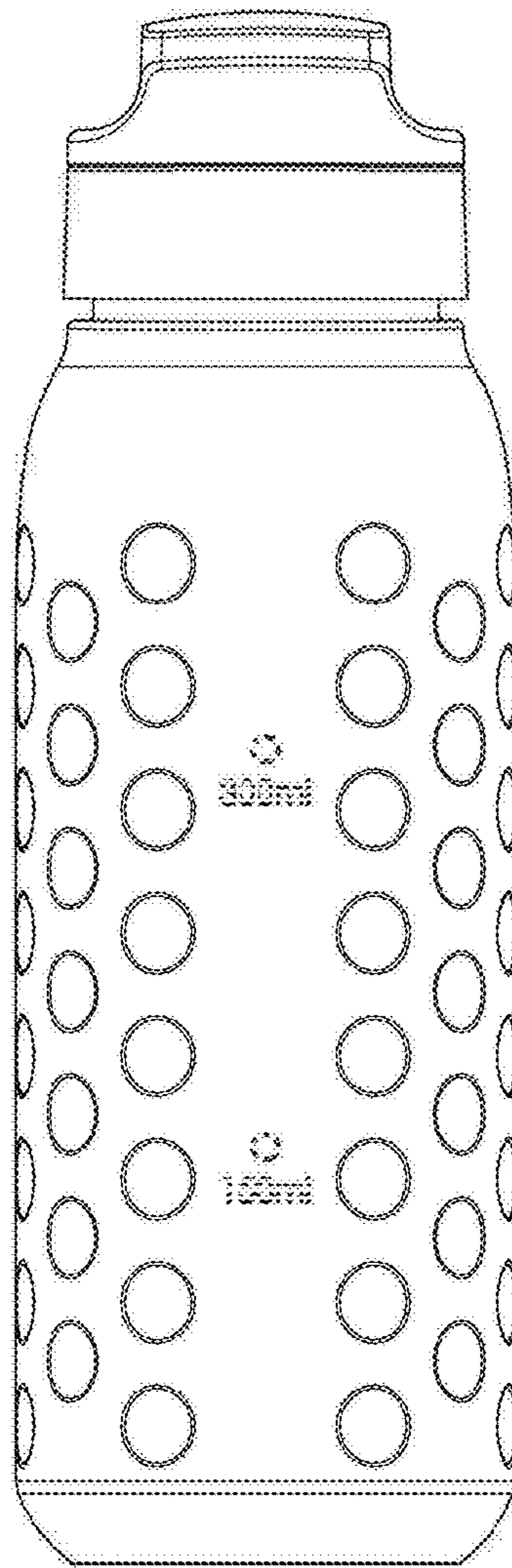

FIG. 1

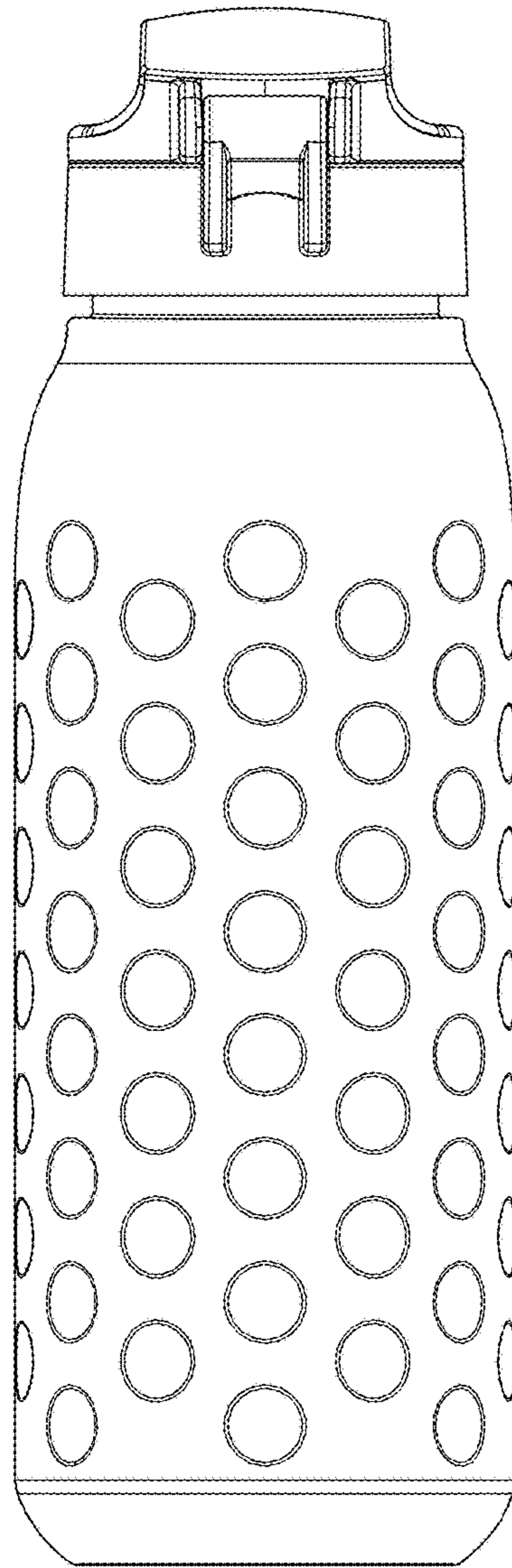

FIG. 2

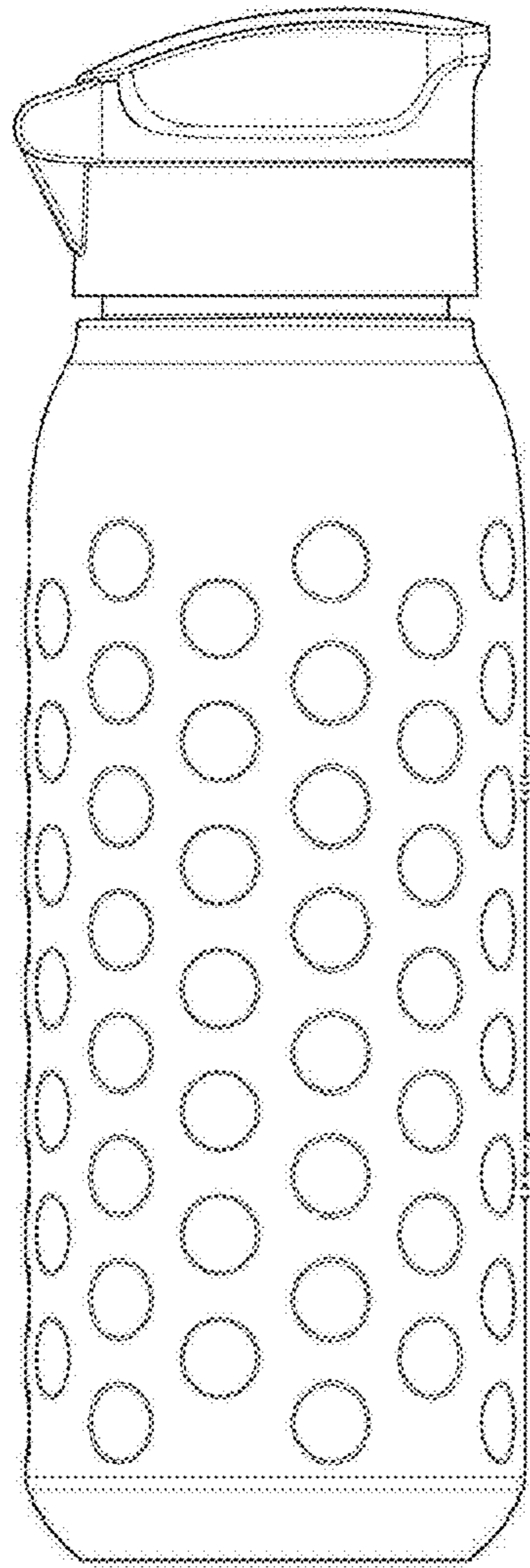

FIG.3

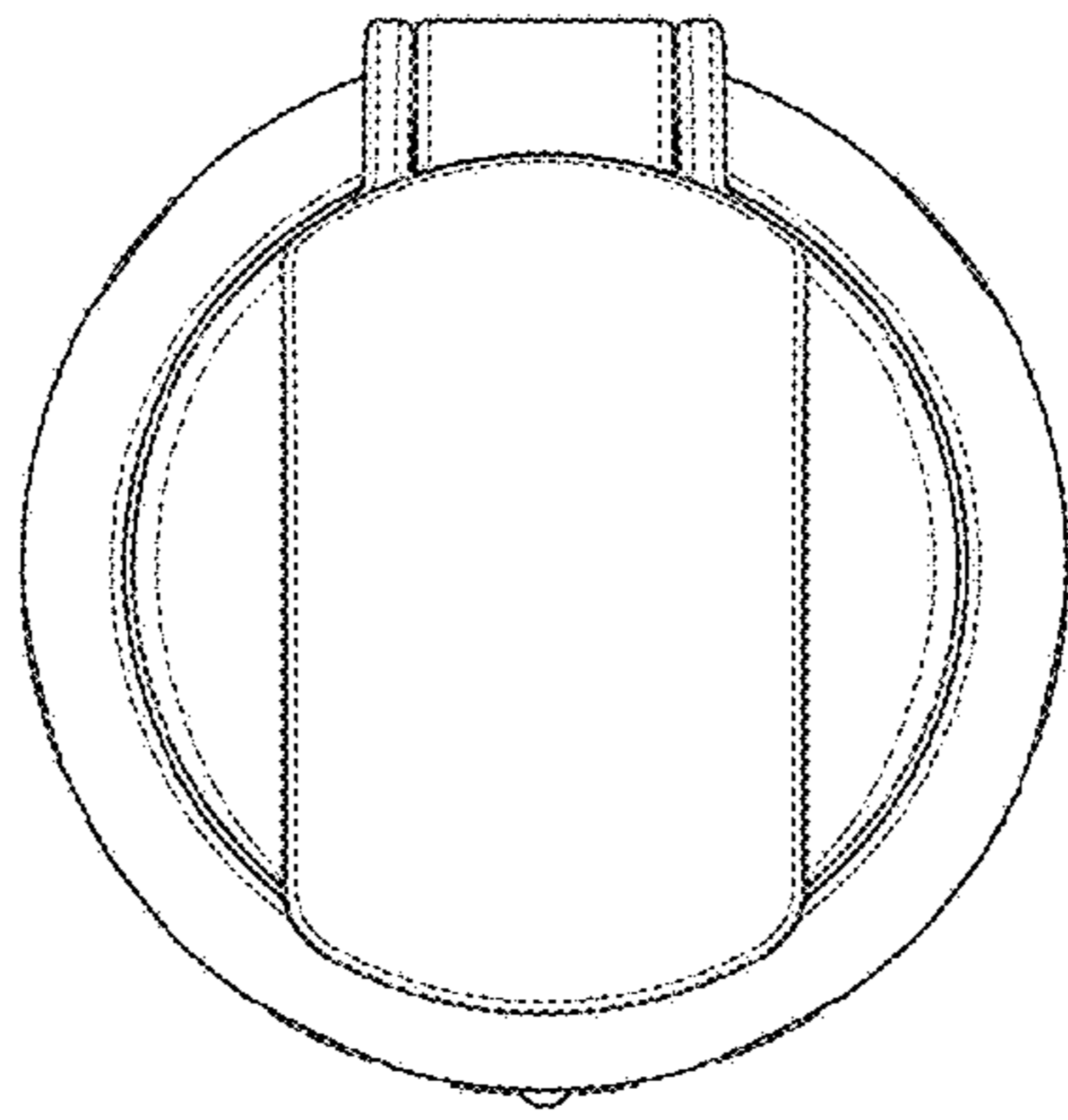

FIG.4

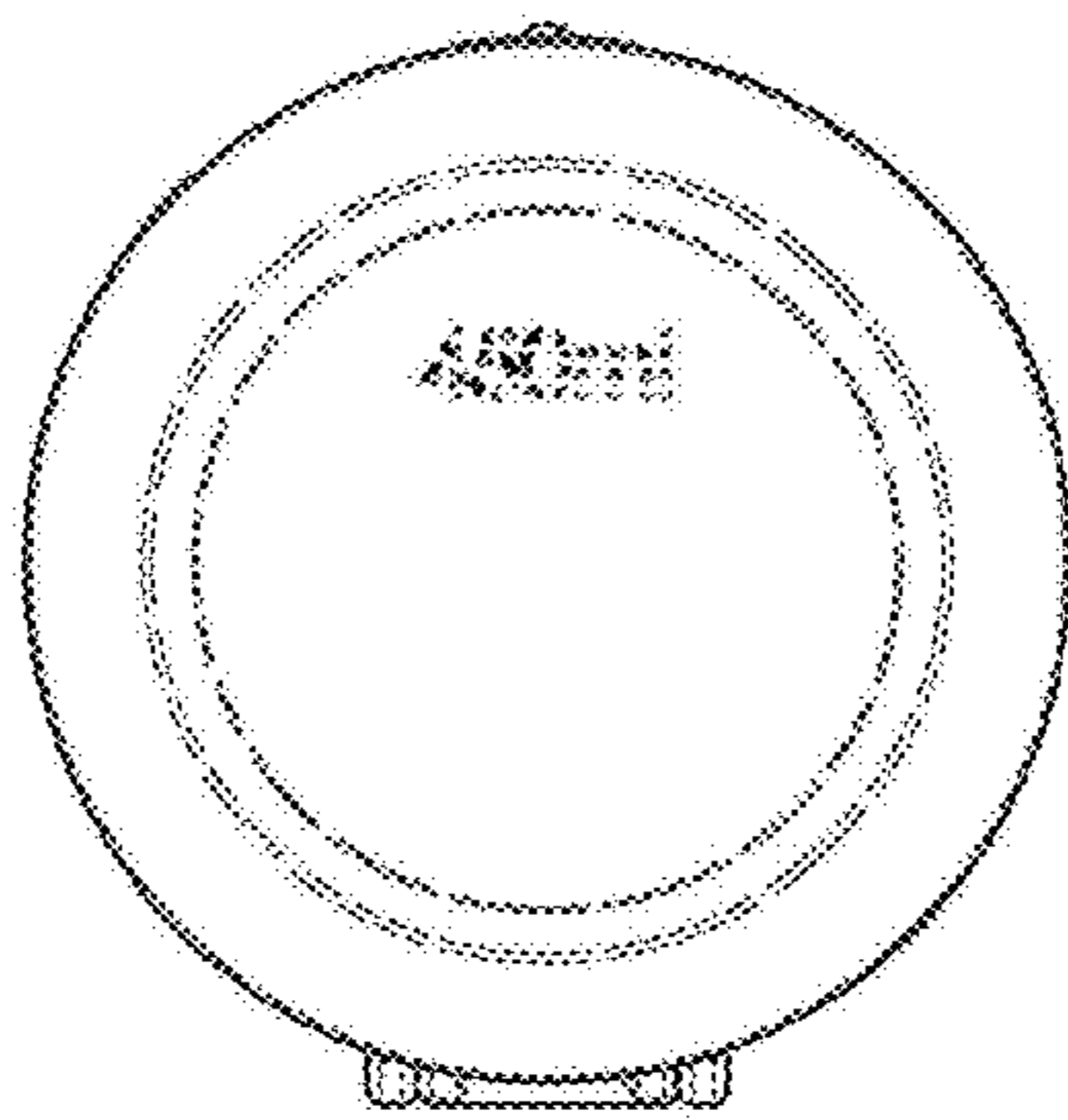

FIG. 5

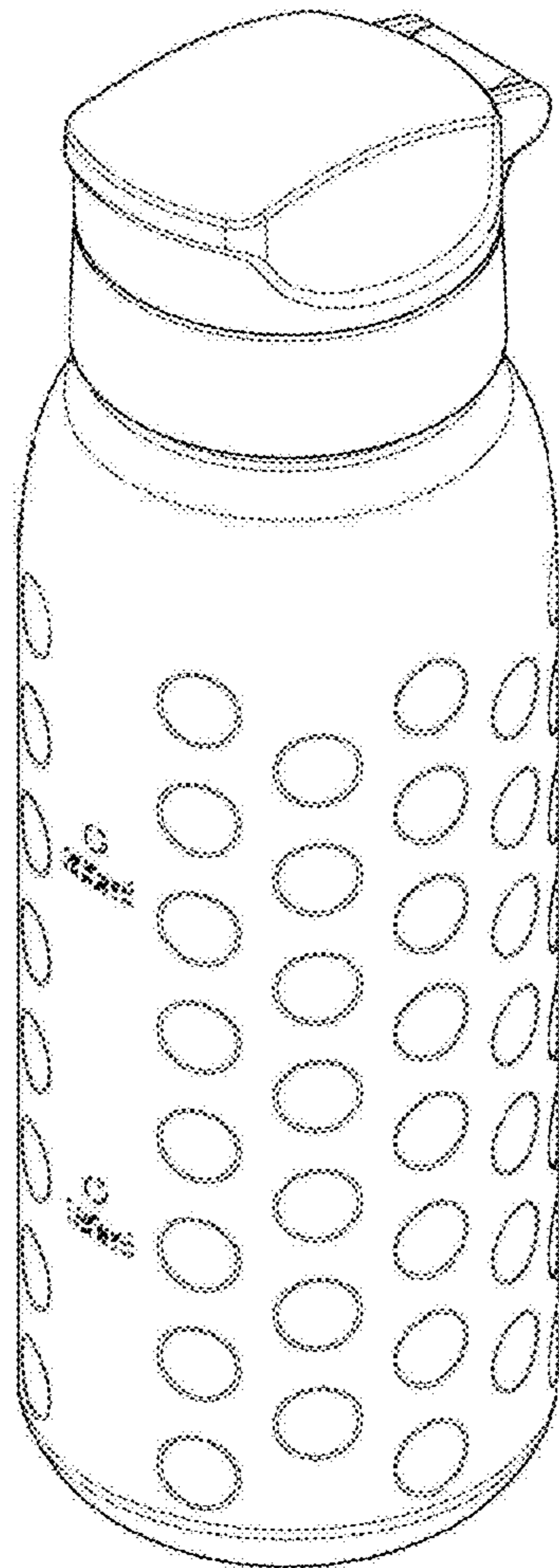

FIG.6

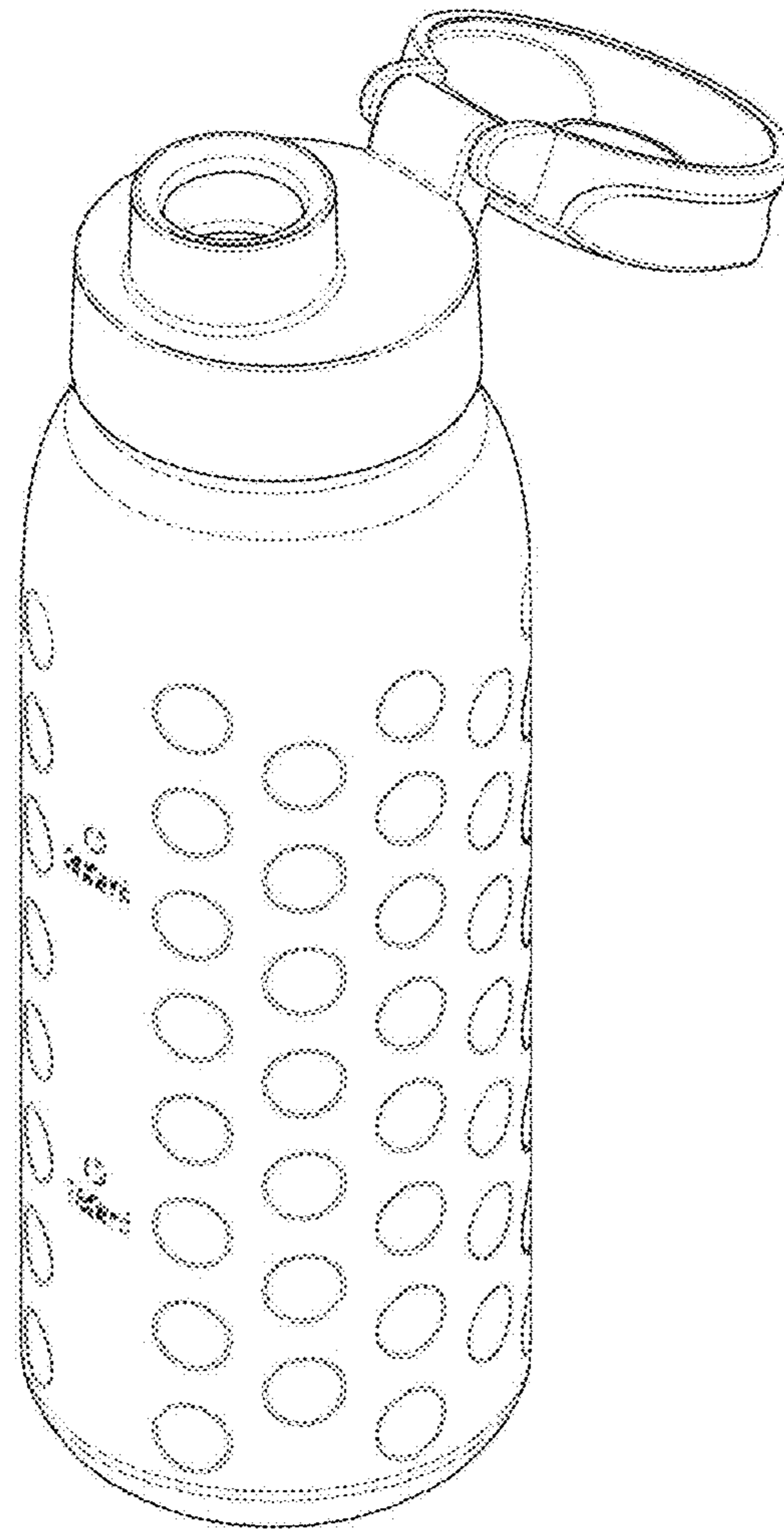

FIG.7

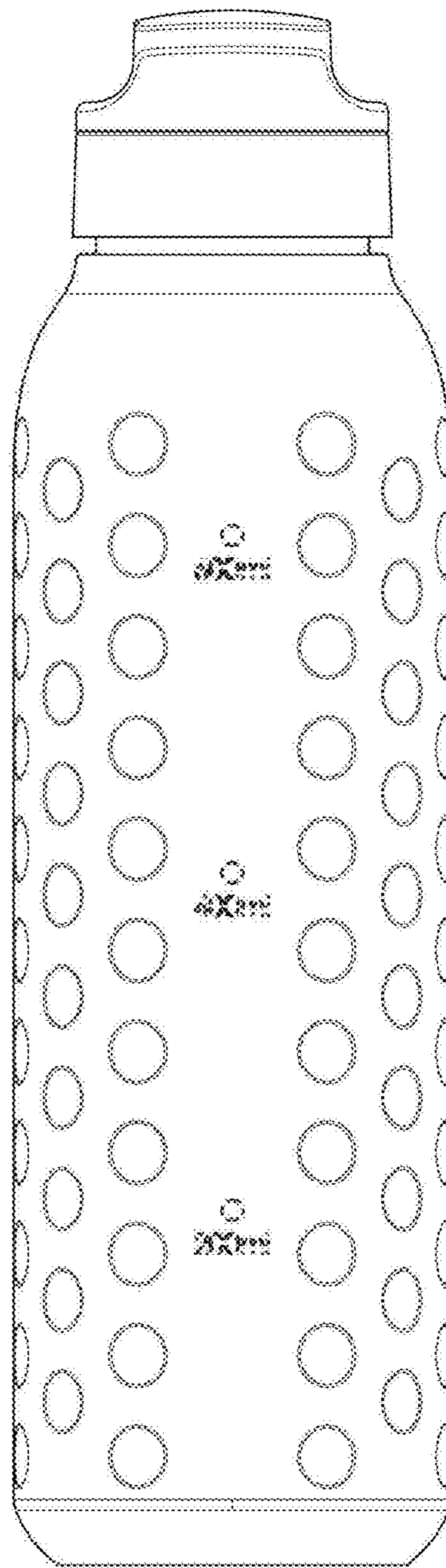

FIG. 8

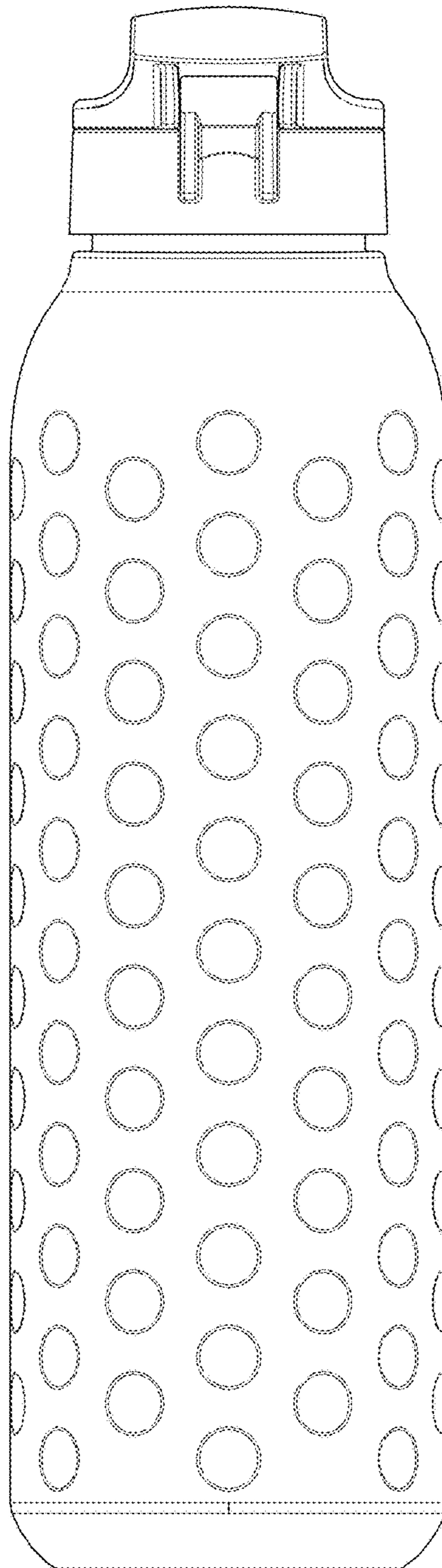

FIG.9

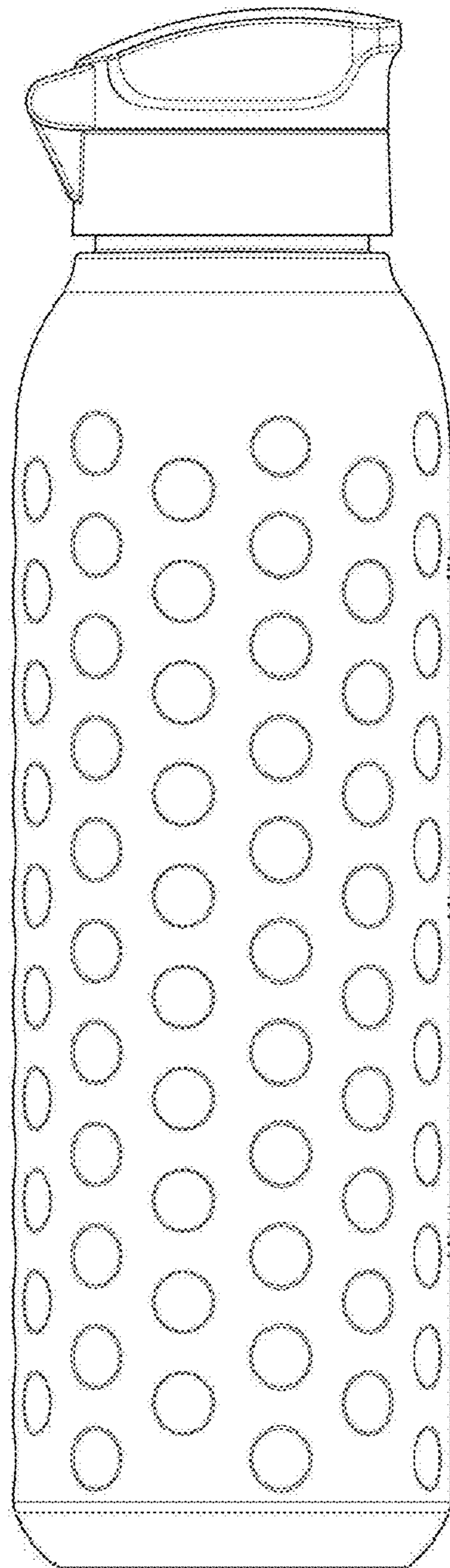

FIG. 10

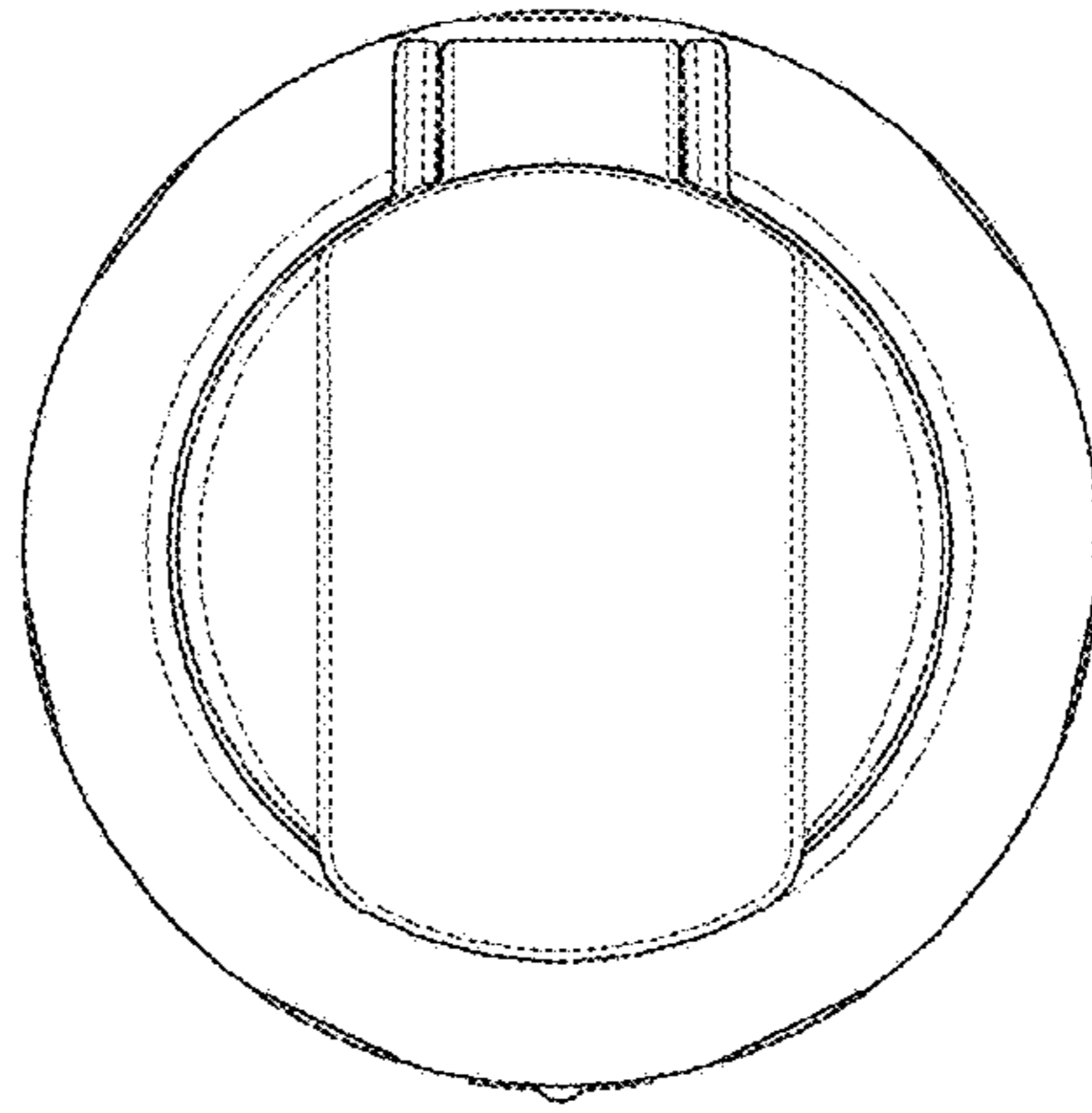

FIG. 11

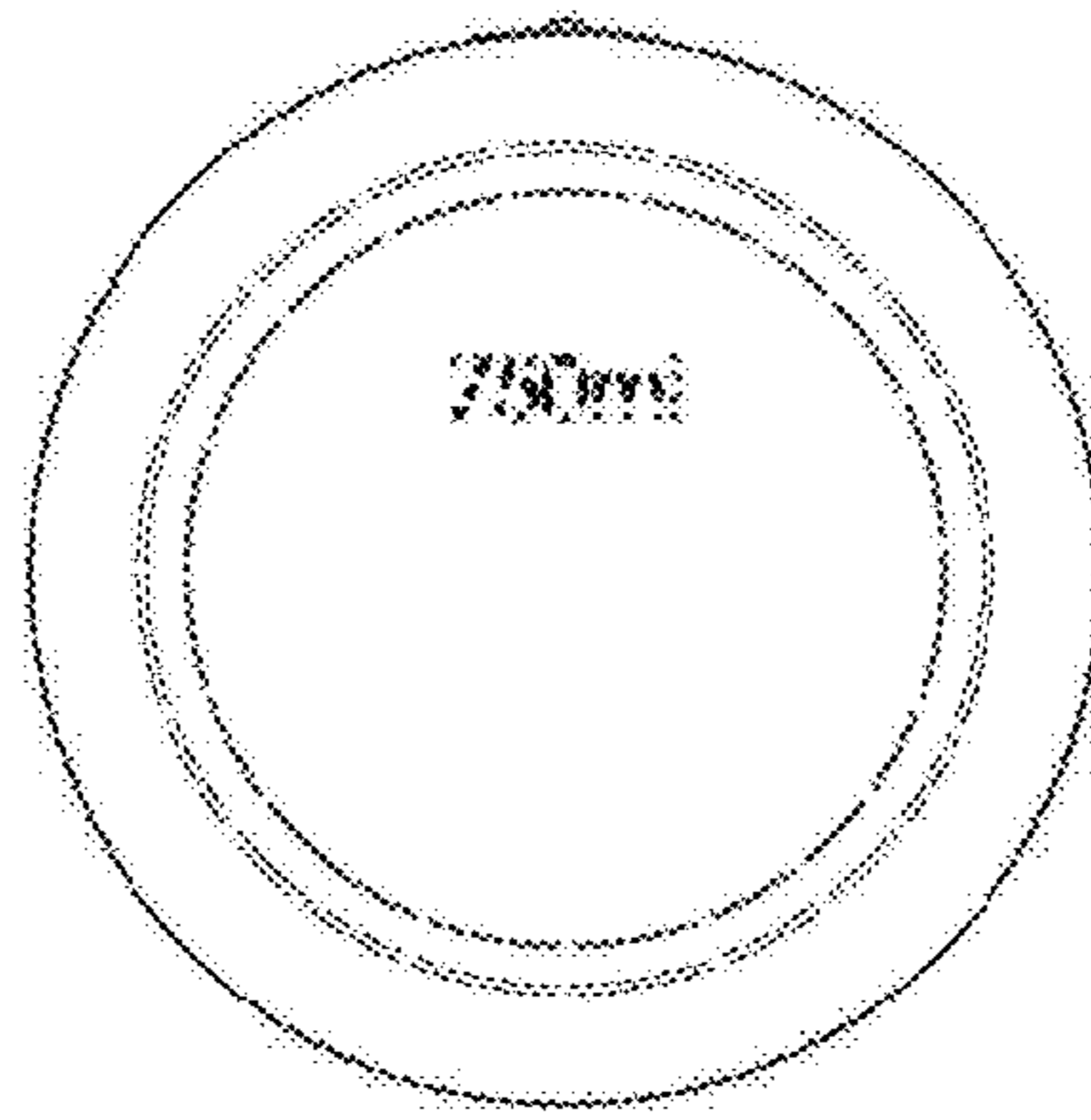

FIG. 12

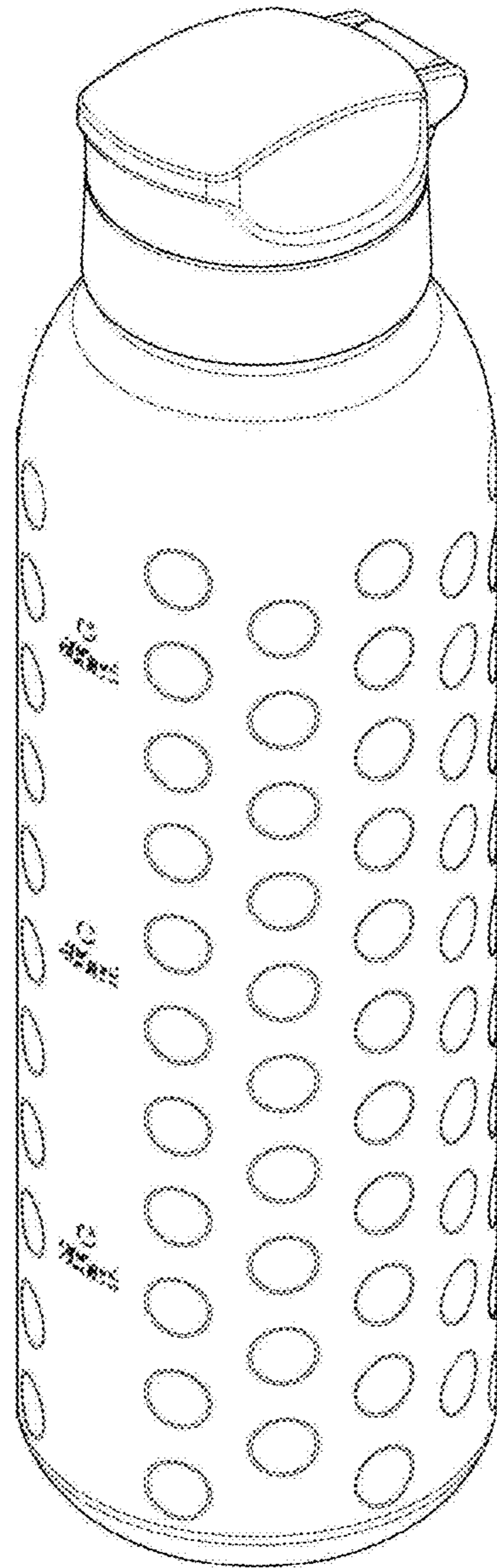

FIG.13

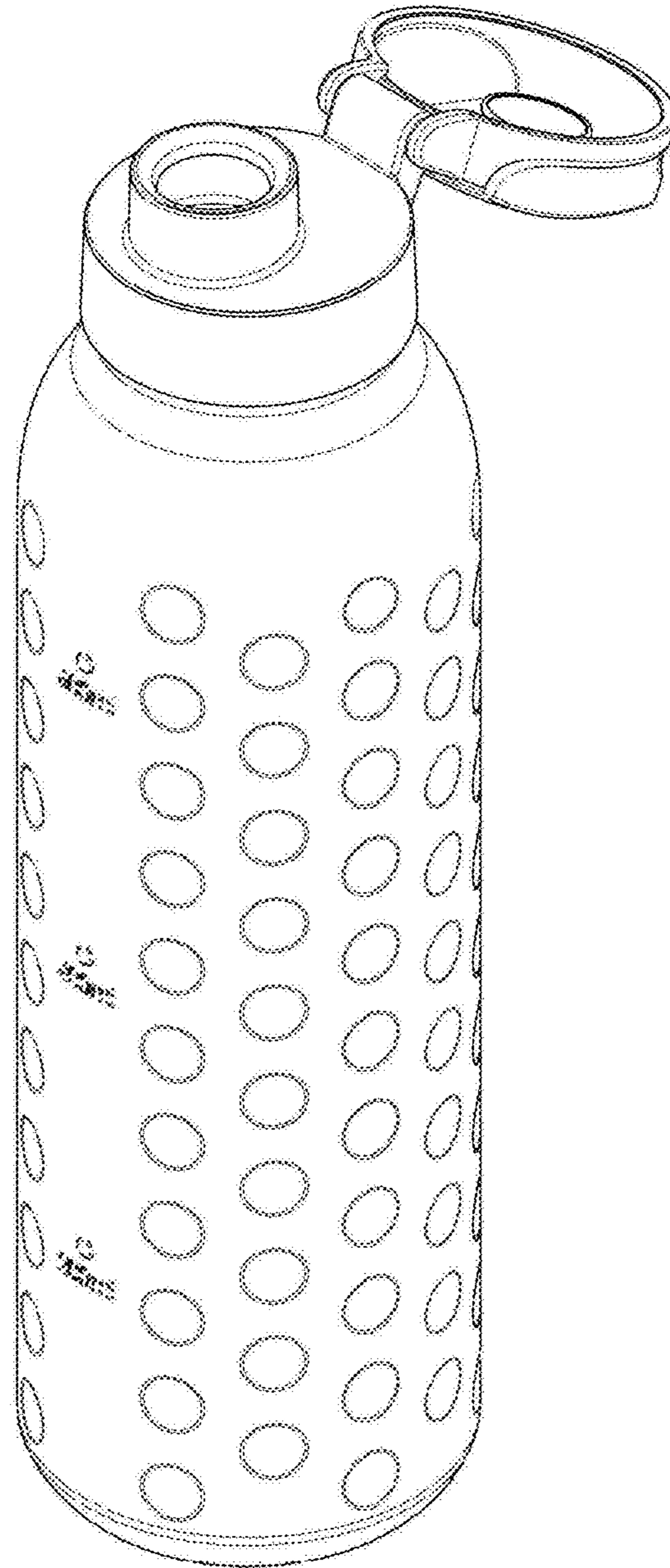

FIG.14