



US00D848744S

(12) **United States Design Patent**  
**Axelbaum**

(10) **Patent No.:** **US D848,744 S**

(45) **Date of Patent:** **\*\* May 21, 2019**

(54) **STRAP**

(71) Applicant: **LITTY BIRD INC.**, Bronx, NY (US)

(72) Inventor: **Sara Axelbaum**, Bronx, NY (US)

(73) Assignee: **LITTY BIRD INC.**, Bronx, NY (US)

(\*\*) Term: **15 Years**

(21) Appl. No.: **29/654,033**

(22) Filed: **Jun. 20, 2018**

(51) **LOC (11) Cl.** ..... **03-01**

(52) **U.S. Cl.**  
USPC ..... **D3/327; D3/318**

(58) **Field of Classification Search**  
USPC ..... D3/327, 318  
CPC ..... A45C 1/10; A45C 3/08; A45F 5/10; A45F  
3/04; A45F 5/00

See application file for complete search history.

(56) **References Cited**

**U.S. PATENT DOCUMENTS**

D435,732 S \* 1/2001 Della Valle ..... D3/327  
D636,603 S \* 4/2011 Cartwright ..... D3/327

D663,955 S \* 7/2012 Swaggart ..... D3/327  
D772,577 S \* 11/2016 Muchin ..... D3/327  
D789,093 S \* 6/2017 Kinskey ..... D3/327  
D793,089 S \* 8/2017 Jackson ..... D3/327

\* cited by examiner

*Primary Examiner* — Holly H Baynham

(74) *Attorney, Agent, or Firm* — Andrew F. Young, Esq.;  
Lackebach Siegel, LLP

(57) **CLAIM**

The ornamental design for a strap, as shown and described.

**DESCRIPTION**

FIG. 1 is a front top perspective view of a strap invention.  
FIG. 2 is a right side elevation view thereof.  
FIG. 3 is a left side elevation view thereof.  
FIG. 4 is a front elevation view thereof.  
FIG. 5 is a rear elevation view thereof.  
FIG. 6 is a top plan view thereof; and,  
FIG. 7 is a bottom plan view thereof.  
The broken lines showing stitching are part of the claimed design.

**1 Claim, 6 Drawing Sheets**

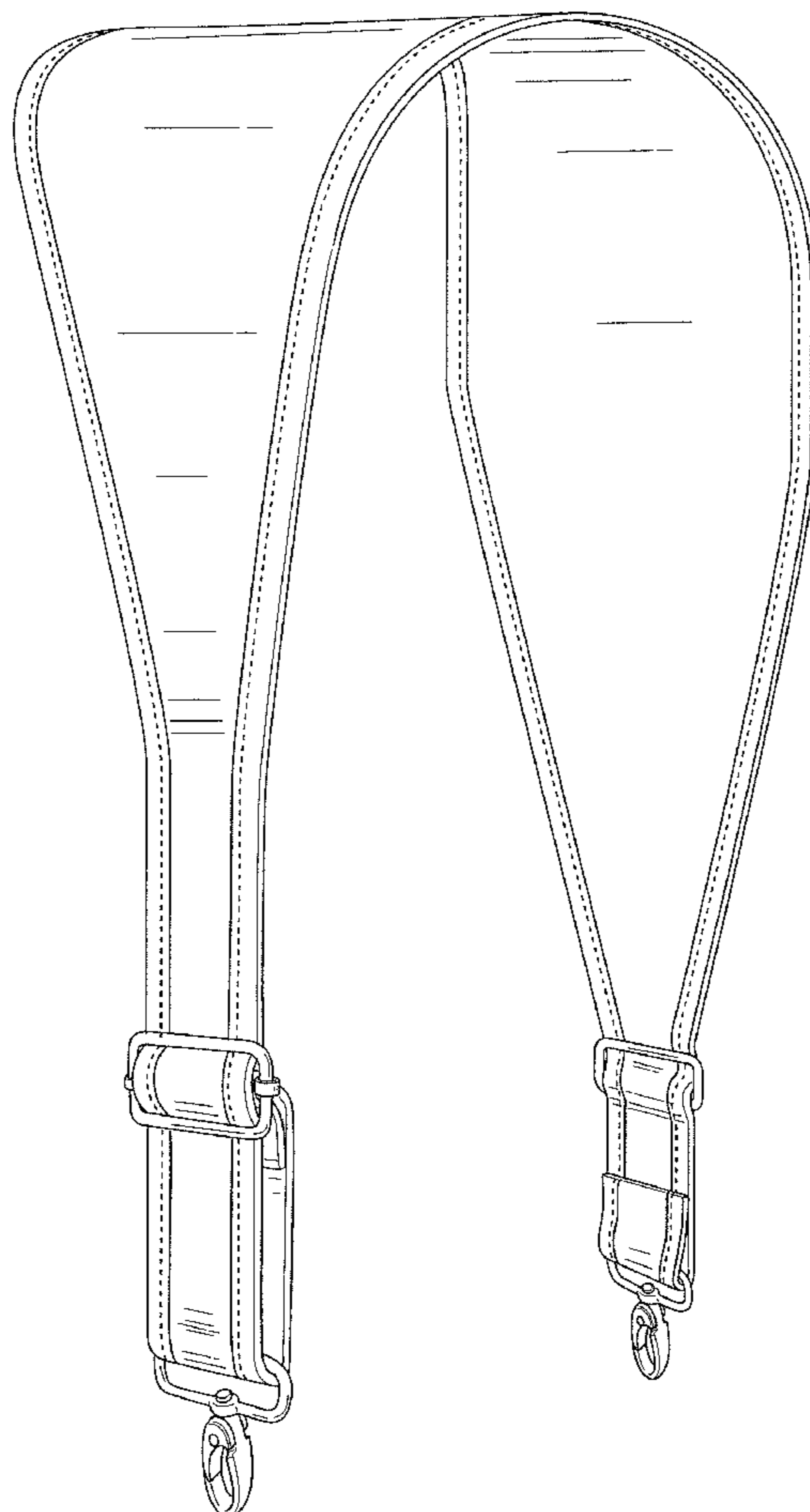

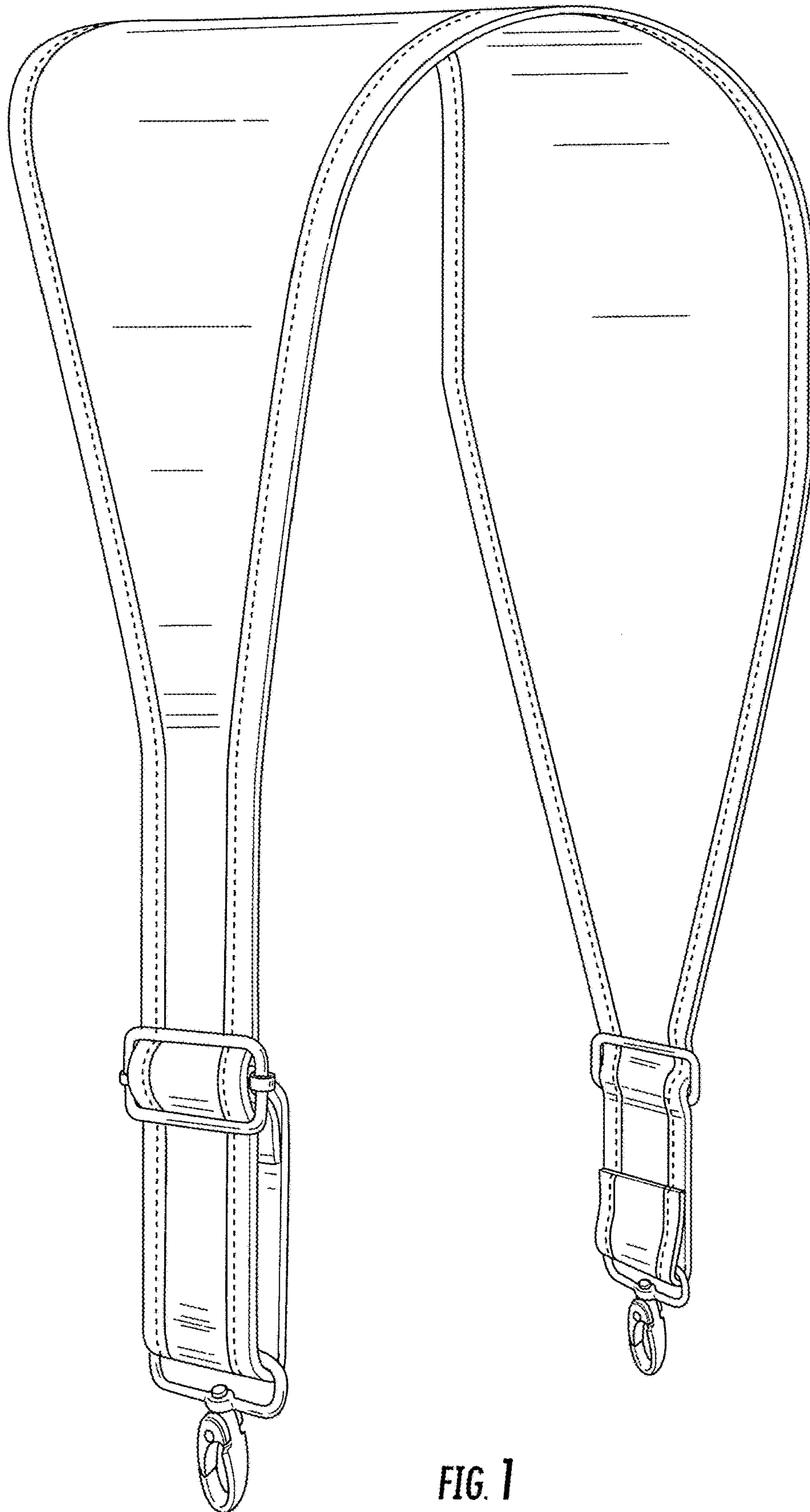

FIG. 1

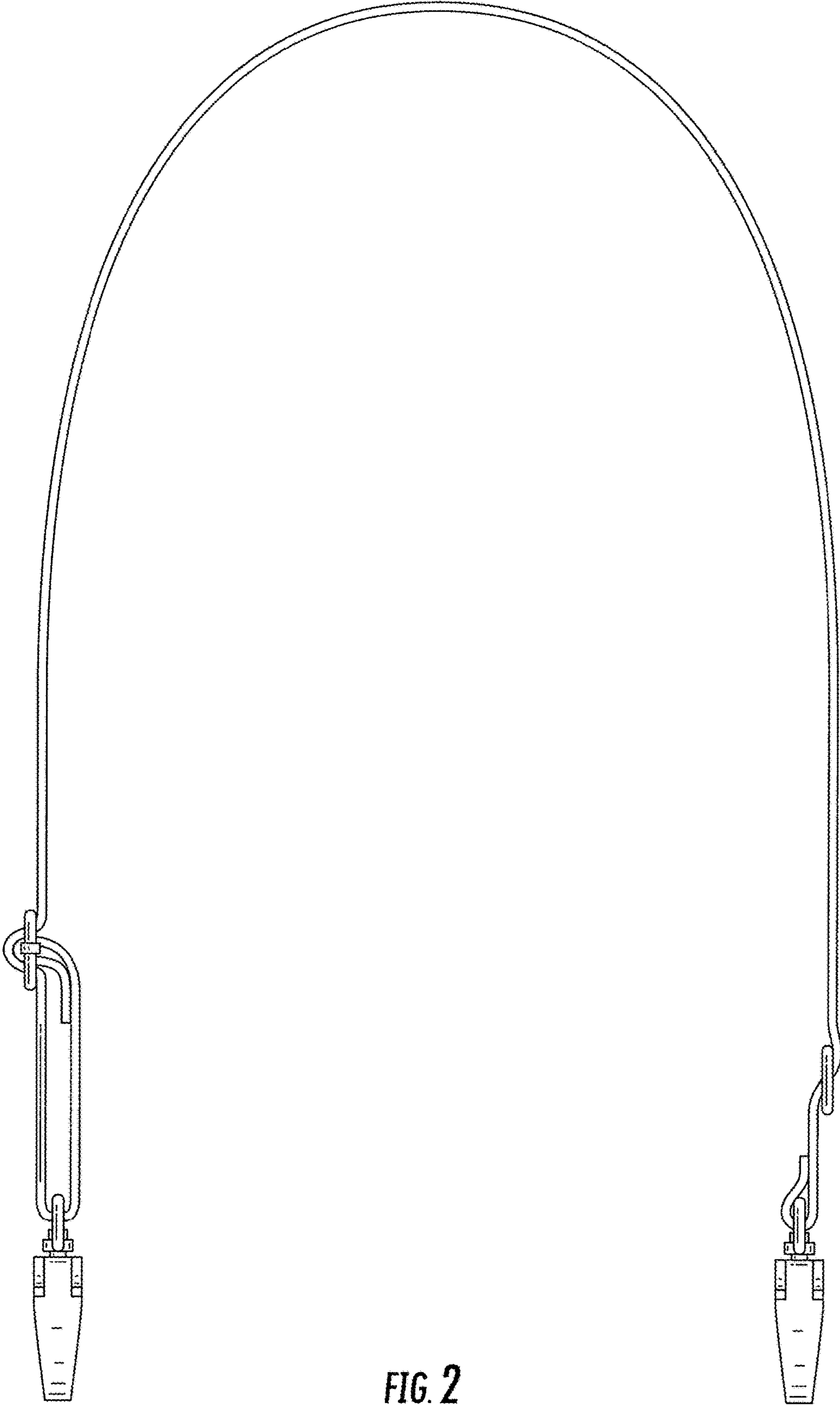

FIG. 2

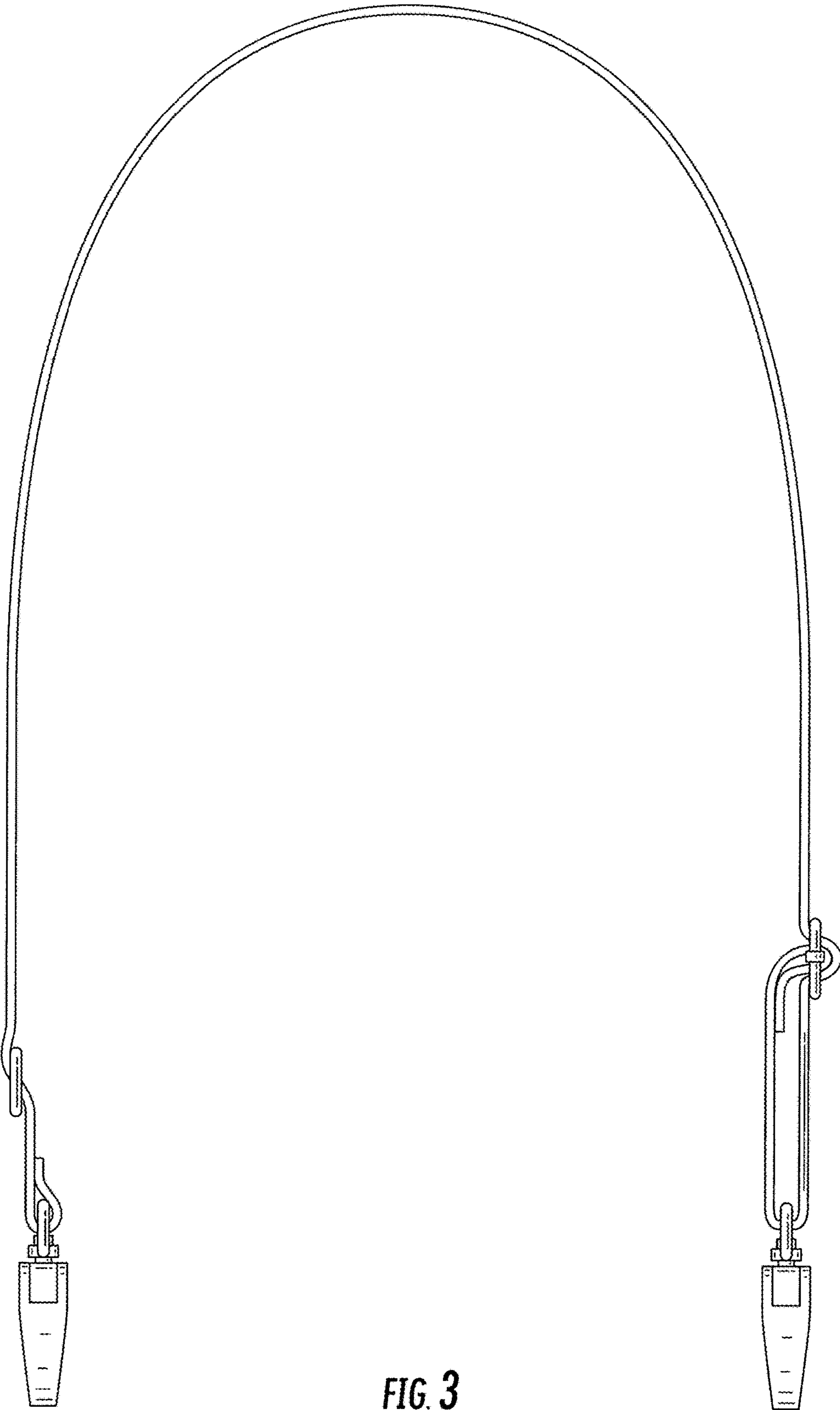

FIG. 3

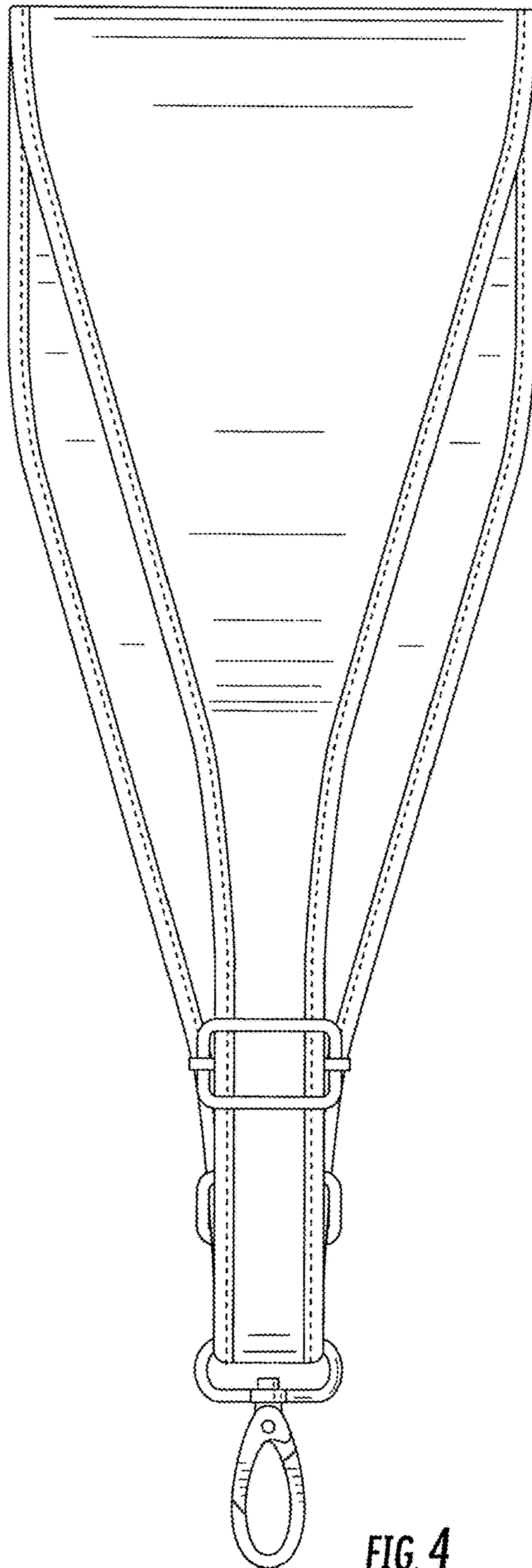

FIG. 4

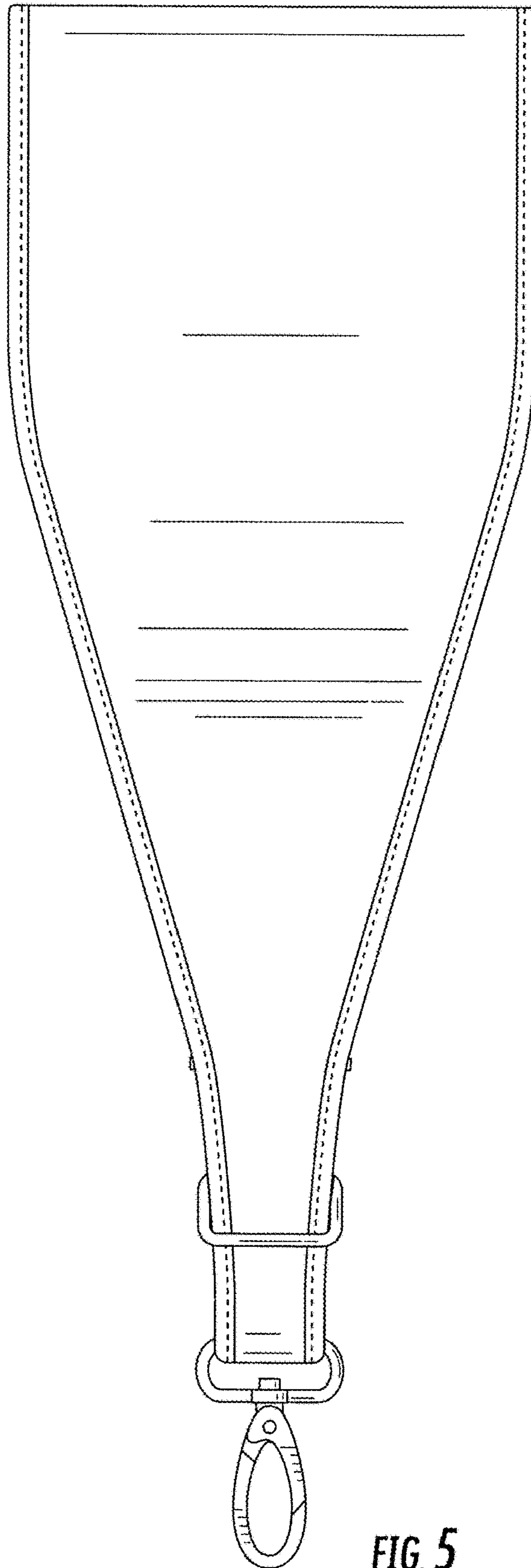

FIG. 5

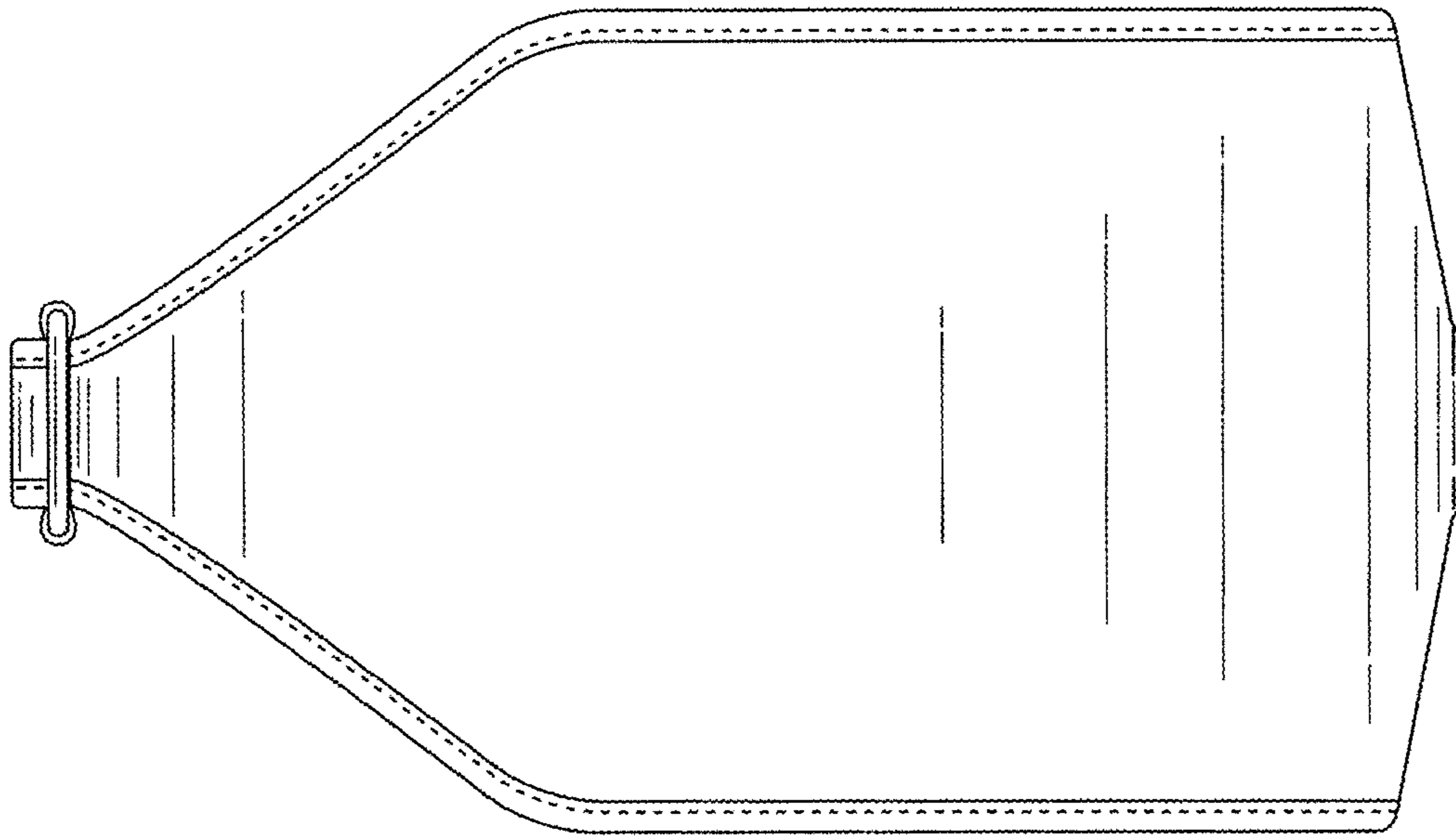

FIG. 6

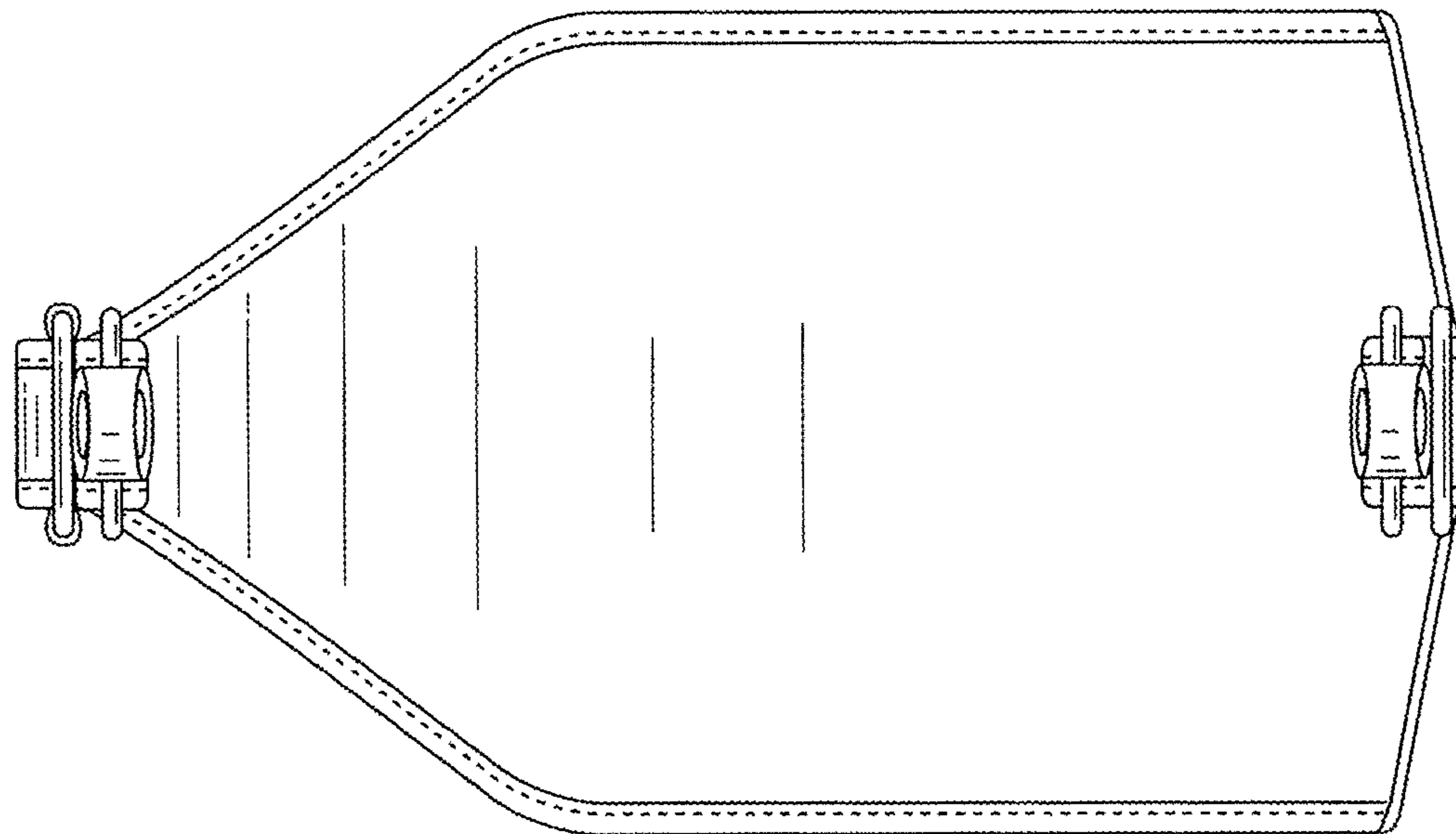

FIG. 7