



US00D848738S

(12) **United States Design Patent** (10) **Patent No.:** **US D848,738 S**
Zhao (45) **Date of Patent:** **** May 21, 2019**

(54) **TOOL BOX**

(71) Applicant: **Jianfeng Zhao**, Guangzhou (CN)

(72) Inventor: **Jianfeng Zhao**, Guangzhou (CN)

(**) Term: **15 Years**

(21) Appl. No.: **29/599,506**

(22) Filed: **Apr. 4, 2017**

(30) **Foreign Application Priority Data**

Jan. 12, 2017 (CN) 2017 3 0012506

(51) **LOC (11) Cl.** **03-01**

(52) **U.S. Cl.**
USPC **D3/294; D3/905**

(58) **Field of Classification Search**
USPC D3/203.2, 203.3, 203.6, 205, 273, 279,
D3/276, 284, 294, 302, 901, 903, 905,
D3/298

(Continued)

(56) **References Cited**

U.S. PATENT DOCUMENTS

D468,531 S * 1/2003 Hsu D3/282
D475,853 S * 6/2003 Chen D3/294

(Continued)

OTHER PUBLICATIONS

Amazon, "Bonafide Hardware™—Smart Phone Repair Tool Kit 32 Piece Set Screw Driver Torx Pentalobe Cell Tools", first review on Feb. 16, 2018. (https://www.amazon.com/dp/B078Z2QY1R/ref=psdc_2407780011_t2_B00XZB3WKQ).*

(Continued)

Primary Examiner — Jennifer Rivard

Assistant Examiner — April Rivas

(74) *Attorney, Agent, or Firm* — Muncy, Geissler, Olds & Lowe, P.C.

(57) **CLAIM**

The ornamental design for a tool box, as shown and described.

DESCRIPTION

FIG. 1 is a perspective view of a first embodiment of a tool box showing my new design, the tool box being in a closed position and having 30 grooves therein;
FIG. 2 is a front elevational view thereof;
FIG. 3 is a rear elevational view thereof;
FIG. 4 is a left side view thereof;
FIG. 5 is a right side view thereof;
FIG. 6 is a top plan view thereof;
FIG. 7 is a bottom plan view thereof;
FIG. 8 is a perspective view of the tool box in an alternate, opened position;
FIG. 9 is a front elevational view thereof;
FIG. 10 is an enlarged view of the top portion of FIG. 9;
FIG. 11 is a cross-sectional view taken along line 11-11 of FIG. 10;
FIG. 12 is a rear elevational view thereof;
FIG. 13 is a left side view thereof;
FIG. 14 is a right side view thereof;
FIG. 15 is a top plan view thereof;
FIG. 16 is a bottom plan view thereof;
FIG. 17 is a perspective view of a second embodiment of a tool box showing my new design, the tool box being in a closed position and having 29 grooves therein;
FIG. 18 is a front elevational view thereof;
FIG. 19 is a rear elevational view thereof;
FIG. 20 is a left side view thereof;
FIG. 21 is a right side view thereof;
FIG. 22 is a top plan view thereof;
FIG. 23 is a bottom plan view thereof;
FIG. 24 is a perspective view of the tool box in an alternate, opened position;
FIG. 25 is a front elevational view thereof;
FIG. 26 is an enlarged view of the top portion of FIG. 25;
FIG. 27 is a cross-sectional view along line 27-27 of FIG. 26;
FIG. 28 is a rear elevational view thereof;
FIG. 29 is a left side view thereof;
FIG. 30 is a right side view thereof;

(Continued)

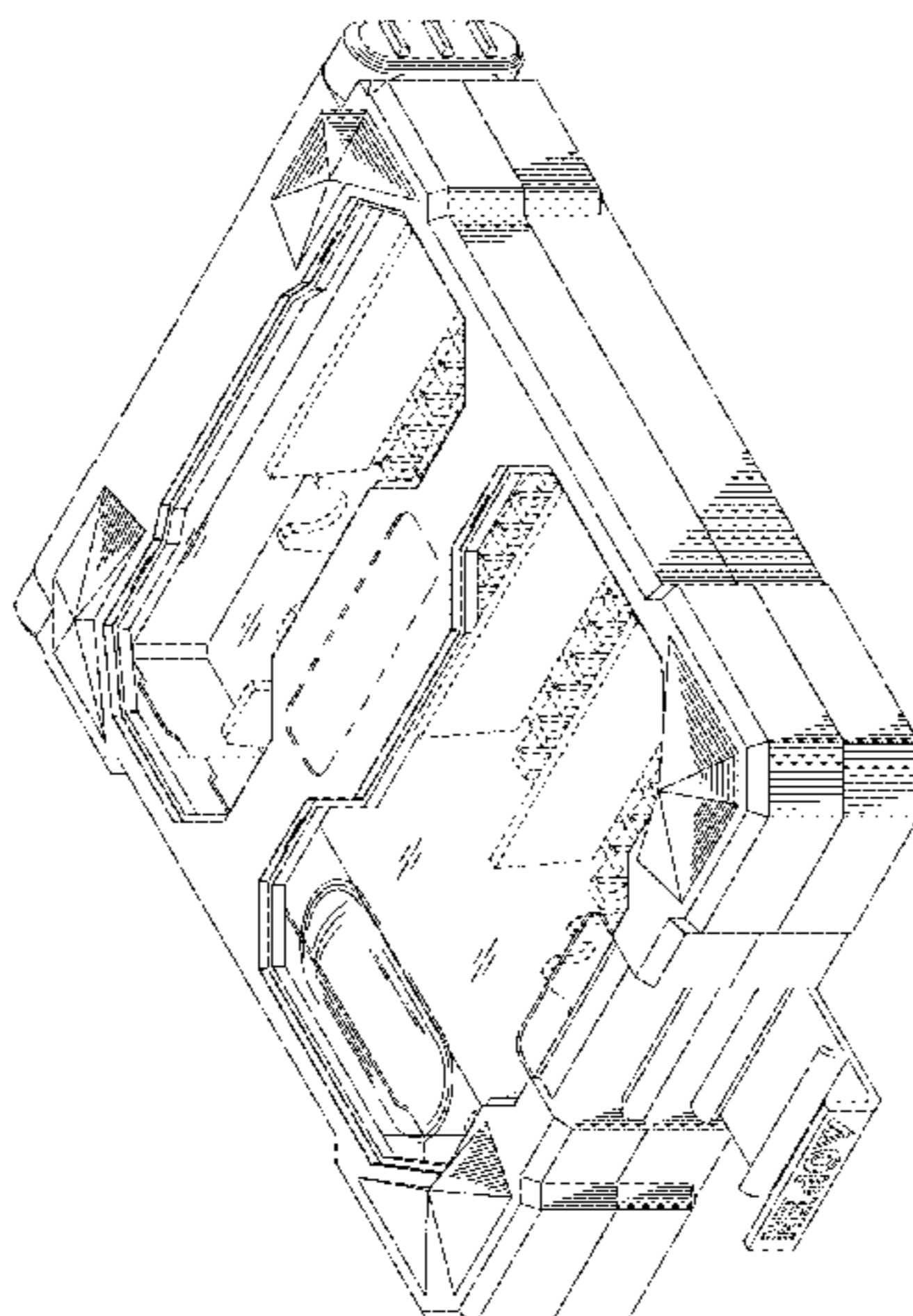

FIG. 31 is a top plan view thereof; and,
 FIG. 32 is a bottom plan view thereof.
 FIGS. 10 and 26 show the base of the tool box separately for
 convenience of illustration only.
 The broken lines illustrate portions of the tool box and form
 no part of the claimed design.

1 Claim, 30 Drawing Sheets

(58) **Field of Classification Search**

CPC B25H 3/00; B25H 3/003; B25H 3/006;
 B25H 3/02; B25H 3/022

See application file for complete search history.

(56) **References Cited**

U.S. PATENT DOCUMENTS

6,905,015 B2 * 6/2005 Hernandez, Jr. B25H 3/003
 206/373
 D528,793 S * 9/2006 Cornwell D3/294
 D532,603 S 11/2006 Chen

D563,671 S * 3/2008 Cornwell D3/294
 D563,672 S * 3/2008 Cornwell D3/294
 D578,307 S 10/2008 Chan et al.
 D645,663 S * 9/2011 Henley D3/294
 D668,866 S * 10/2012 Meng D3/273
 D690,934 S * 10/2013 Robinson D3/294
 D714,552 S 10/2014 Jiang
 D715,548 S * 10/2014 Chang D3/294
 D721,891 S * 2/2015 Ben-Gigi D3/282
 D778,610 S * 2/2017 Chen D3/302
 D789,086 S * 6/2017 Lin D3/294

OTHER PUBLICATIONS

Aliexpress, "LAOA 25 in 1 Precise Precision Screwdriver Set . . .
 ", first review on Aug. 20, 2017. (<https://www.aliexpress.com/item/25in1-Green-S2-Repair-Tools-Kit-Magnetic-Precision-Torx-Screwdriver-Set-for-Cell-Phone-iPad-iPhone/32513911229.html>).*

Aliexpress, "32 in 1 S2 Precision Screwdrivers multifunction precise screw driver set", First review on Aug. 22, 2017. (<https://www.aliexpress.com/item/LAOA-32-in-1-multifunction-high-precise-screwdriver-set-Iphone-cellphone-laptop-tool-set/32489566695.html>).*

* cited by examiner

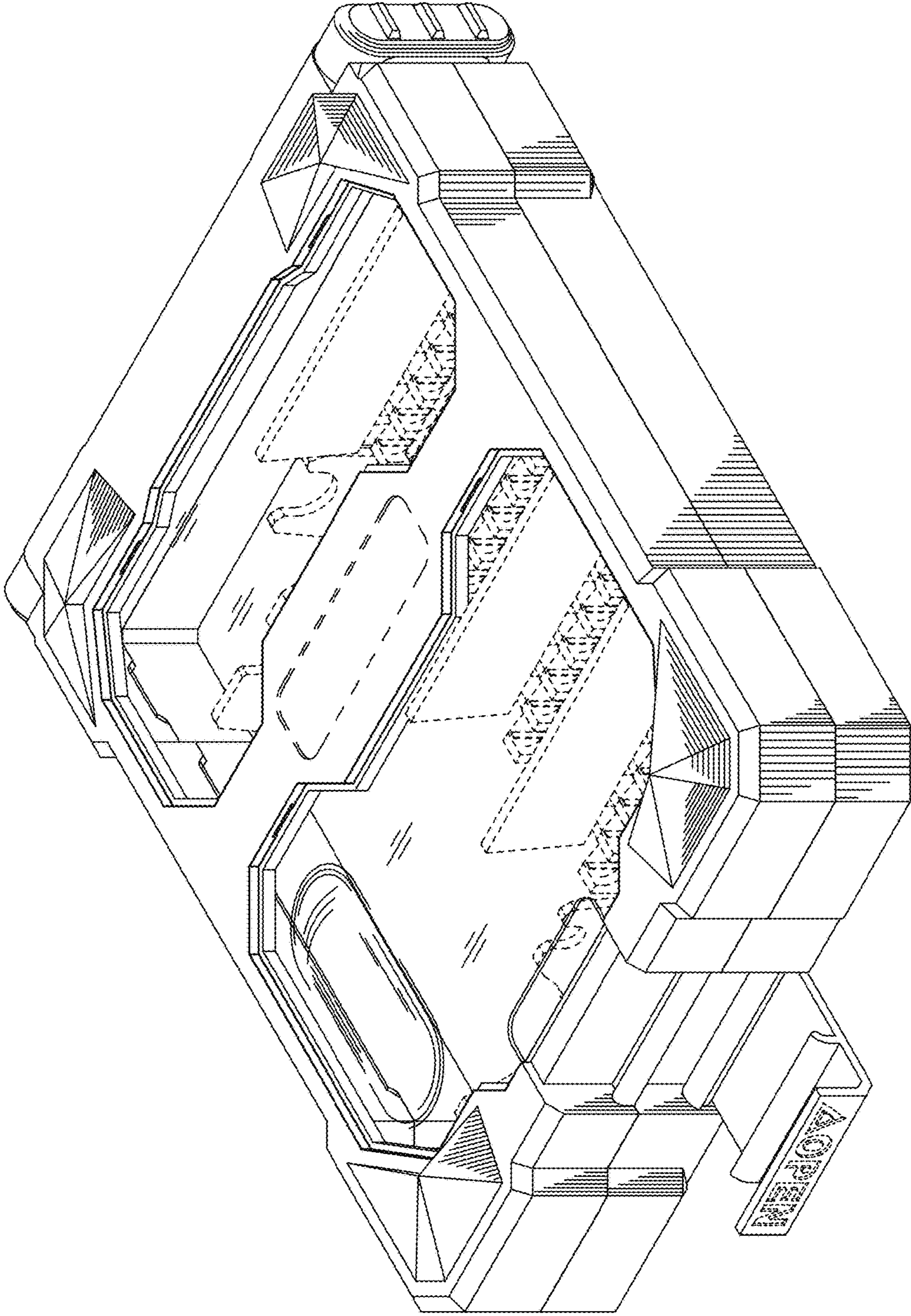

FIG. 1

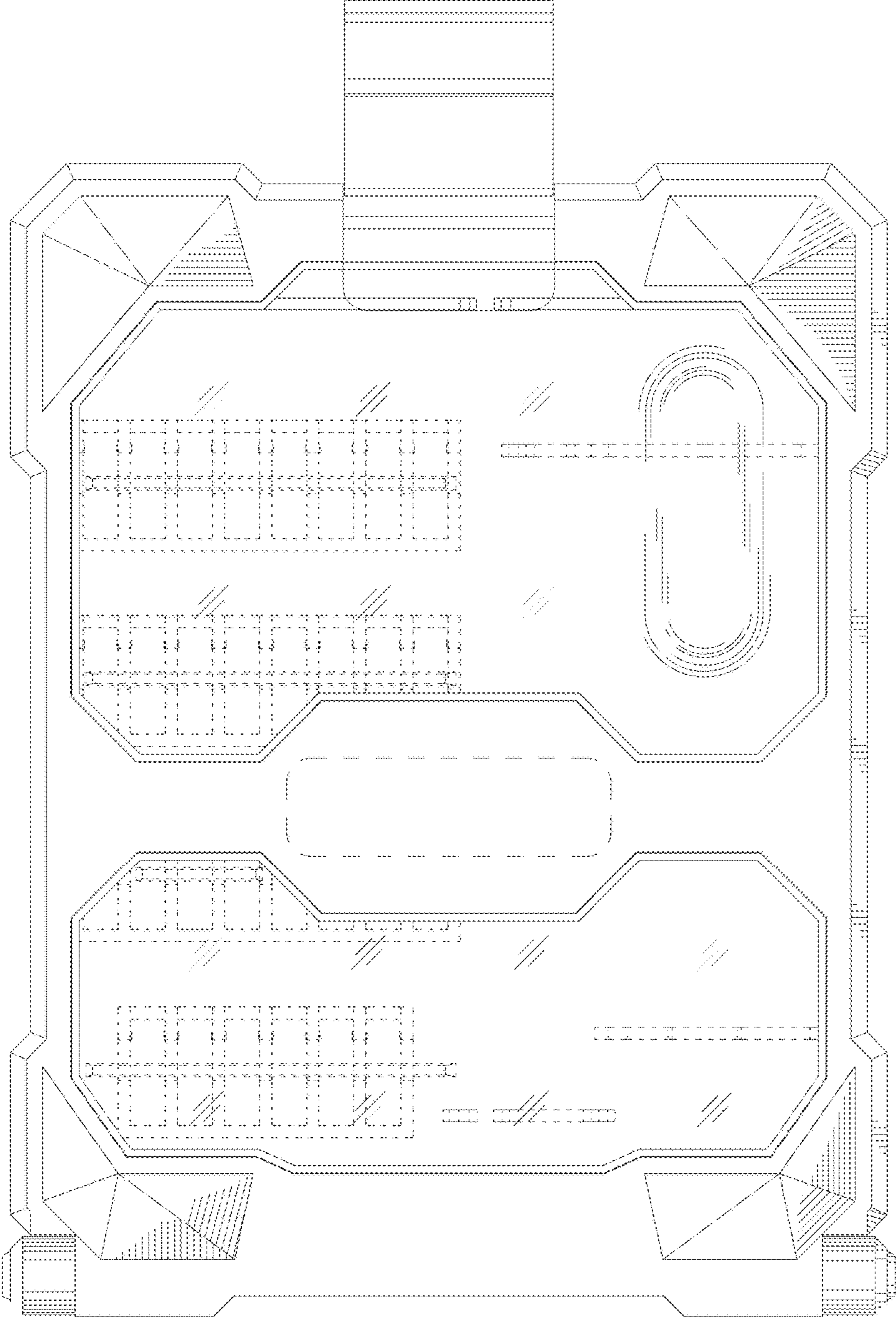

FIG. 2

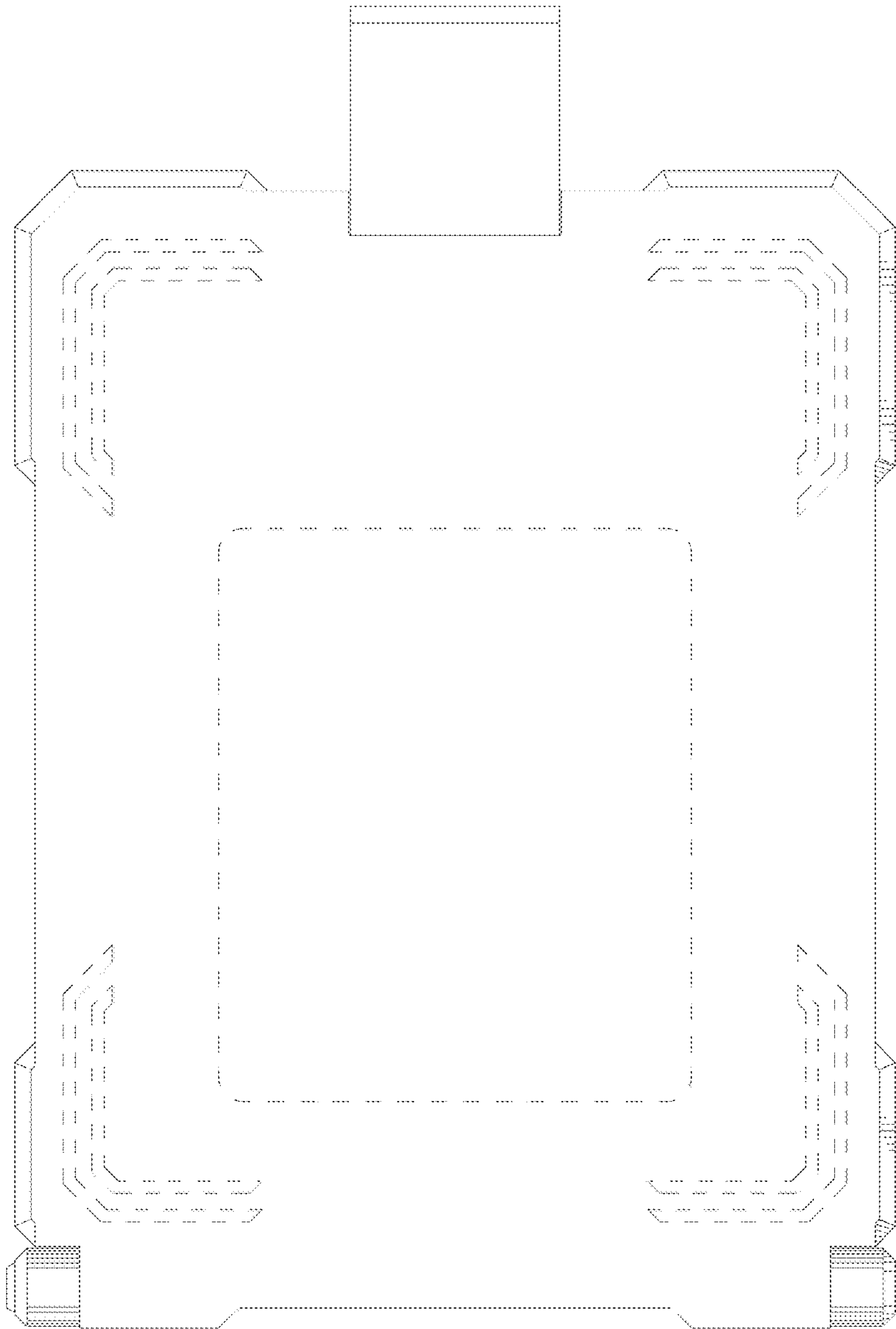

FIG. 3

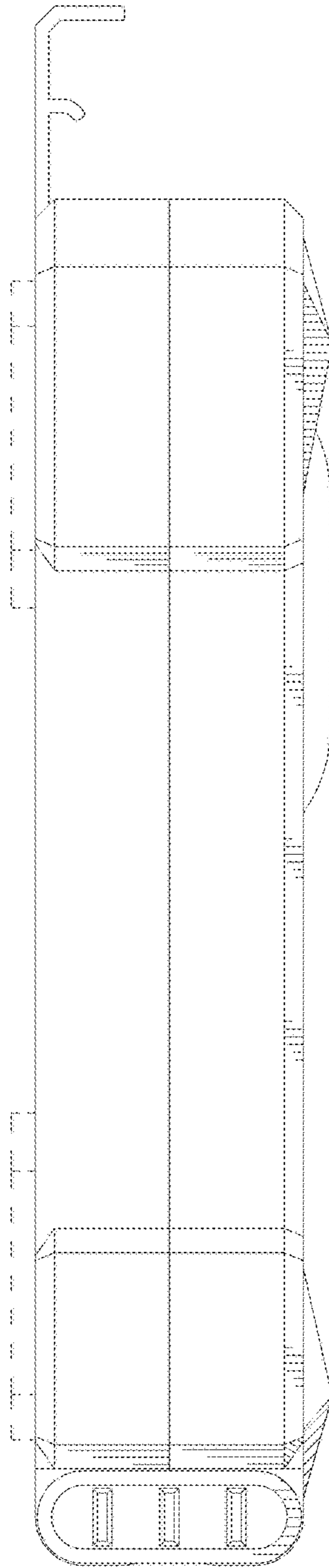

FIG. 4

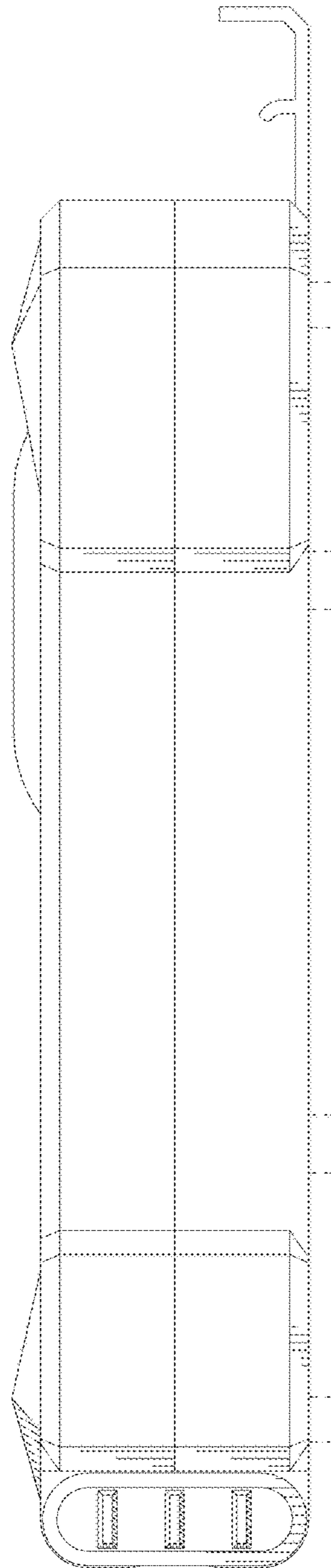

FIG. 5

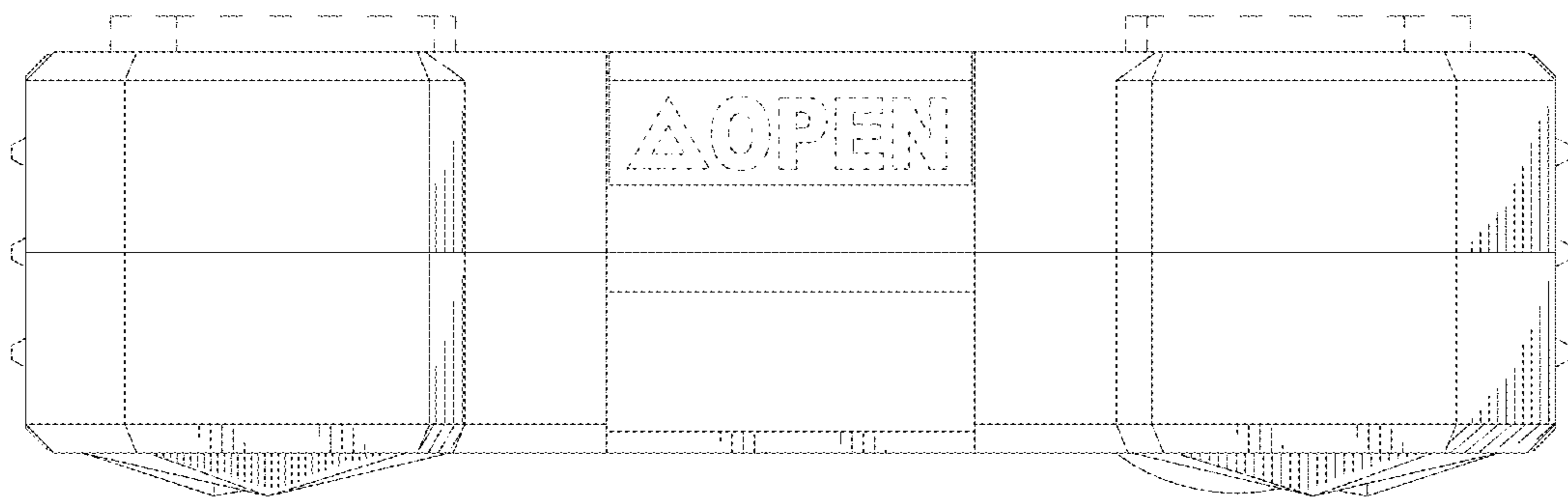

FIG. 6



FIG. 7

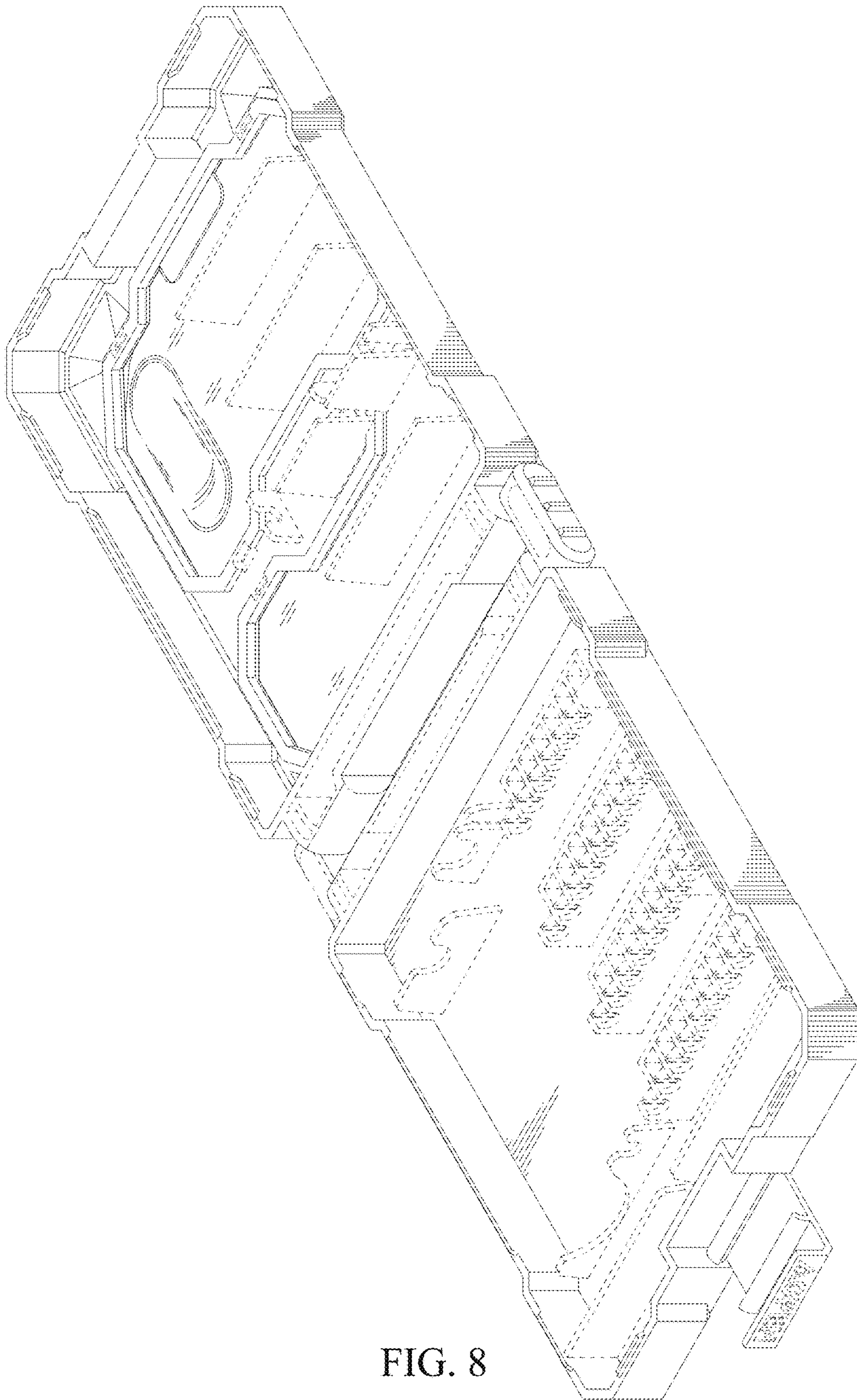

FIG. 8

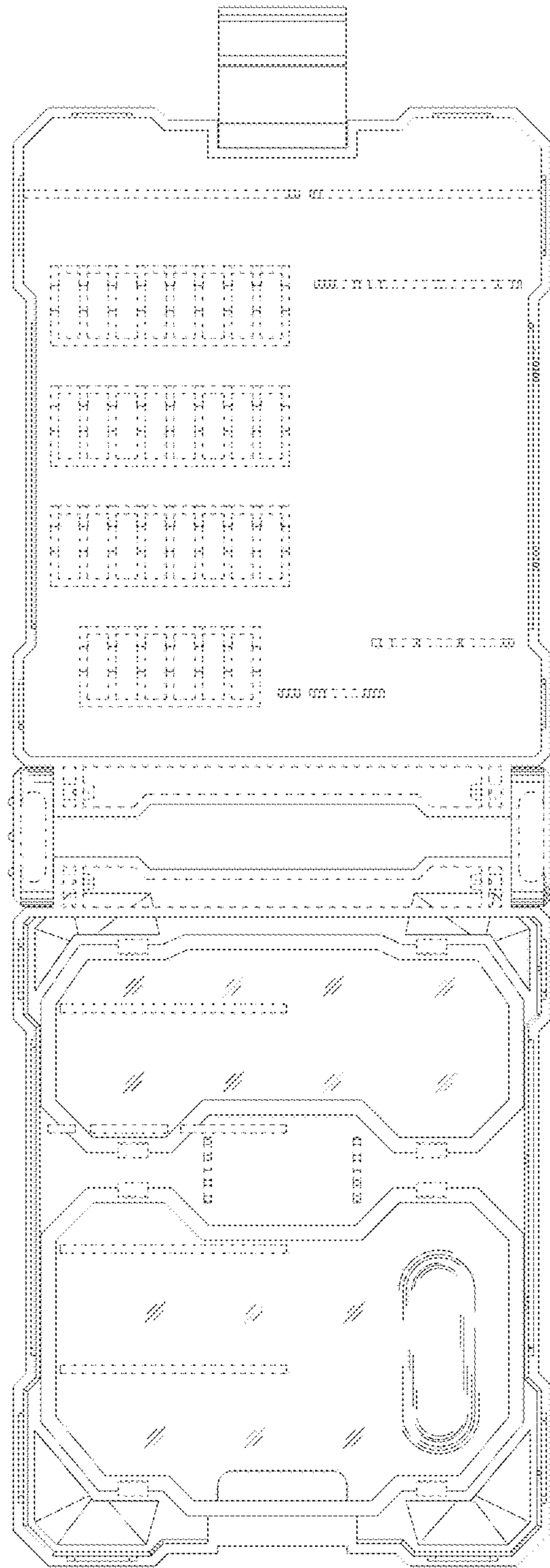

FIG. 9

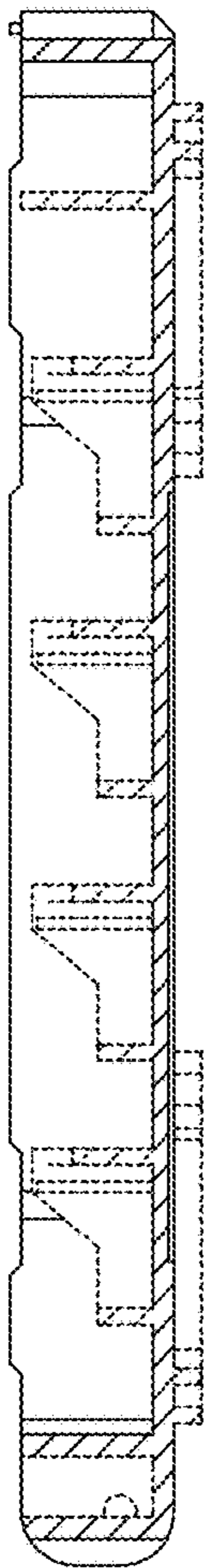

FIG. 11

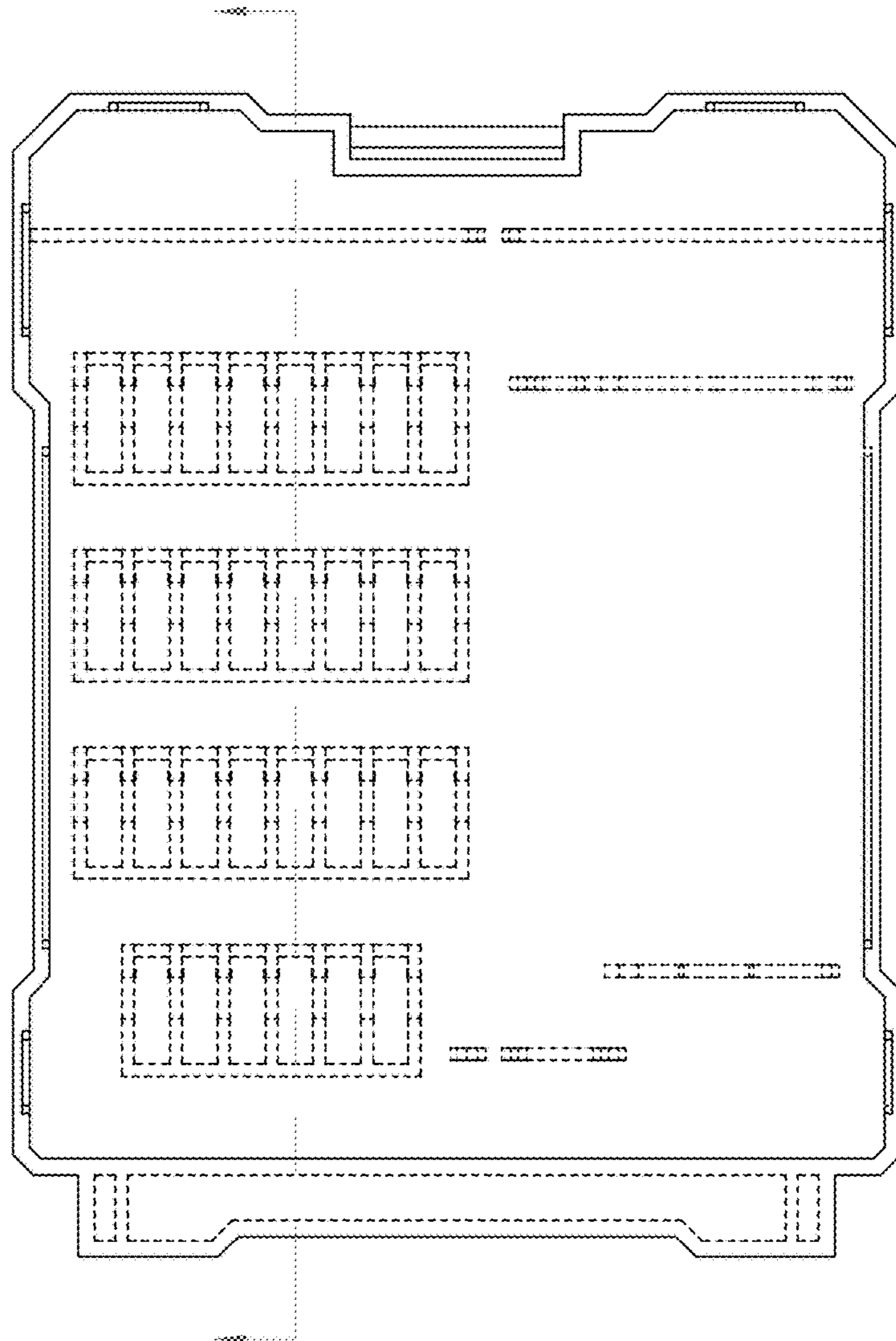

FIG. 10

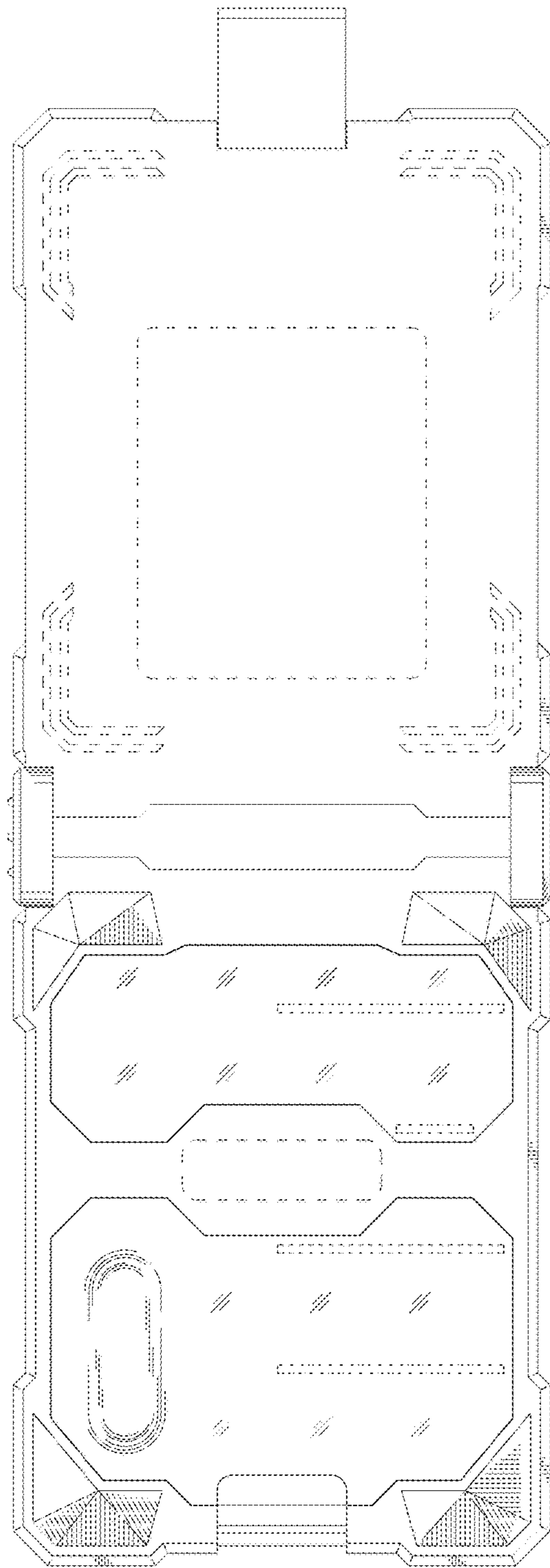

FIG. 12

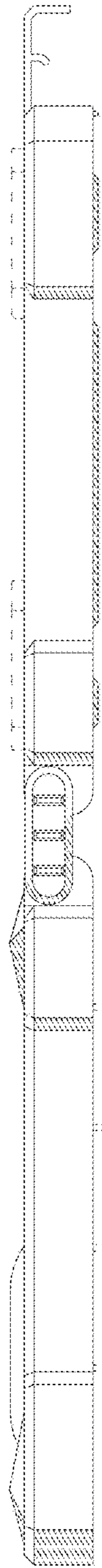

FIG. 13

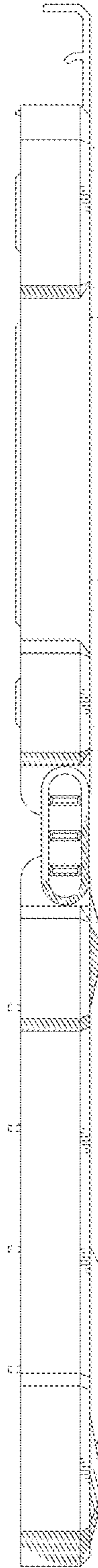

FIG. 14

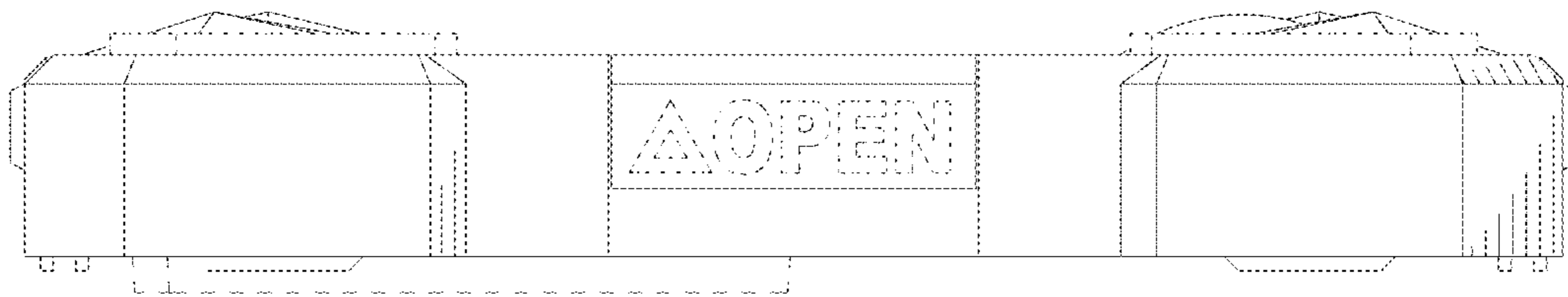

FIG. 15

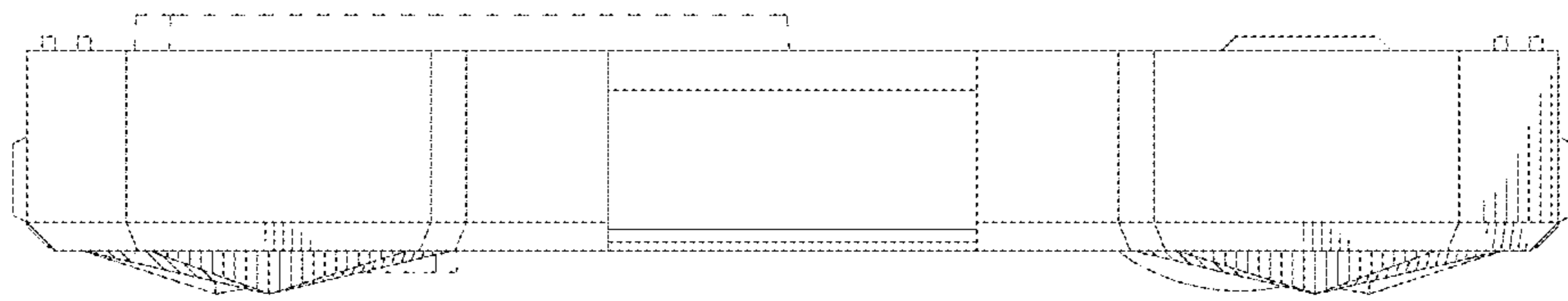

FIG. 16

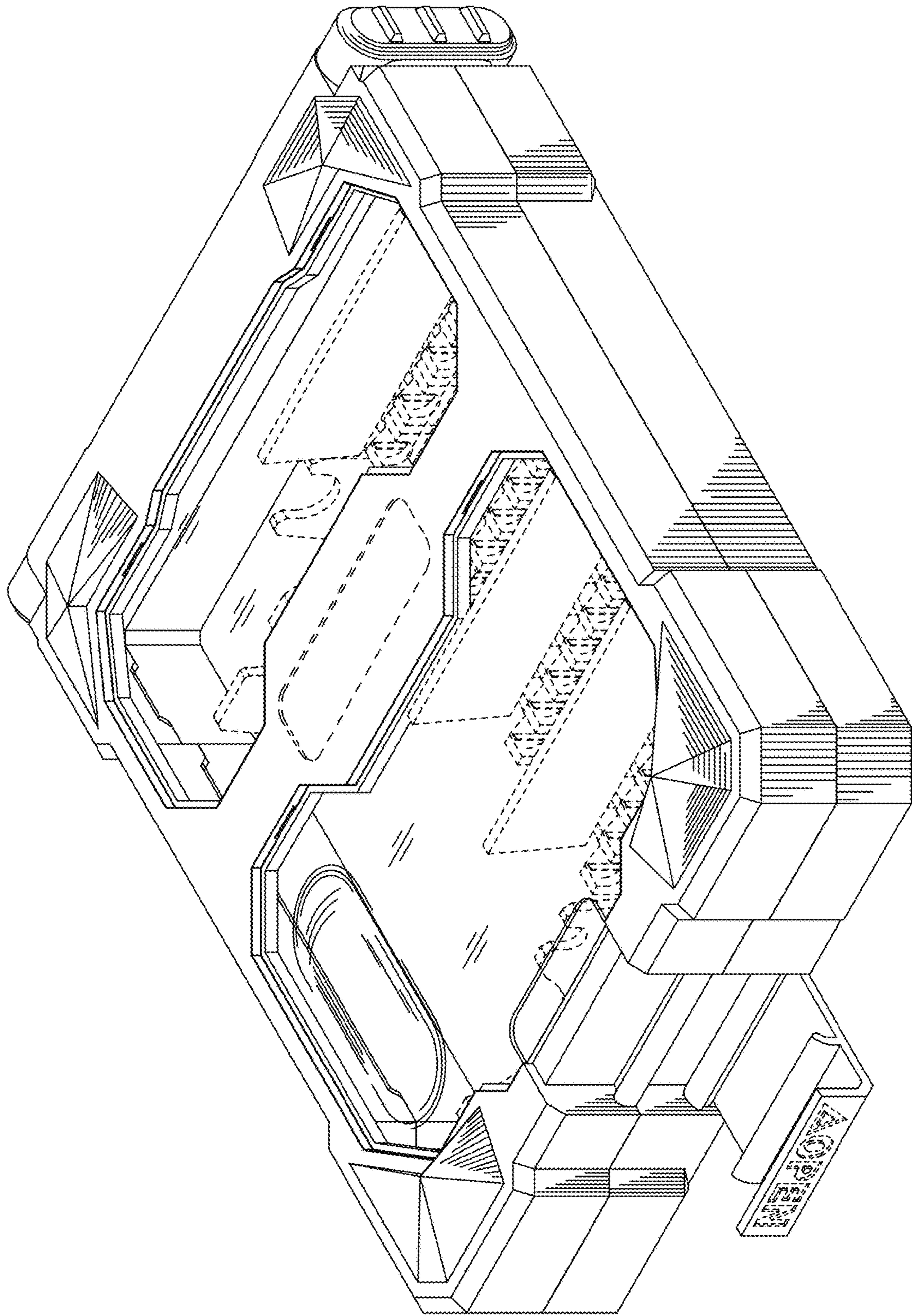

FIG. 17

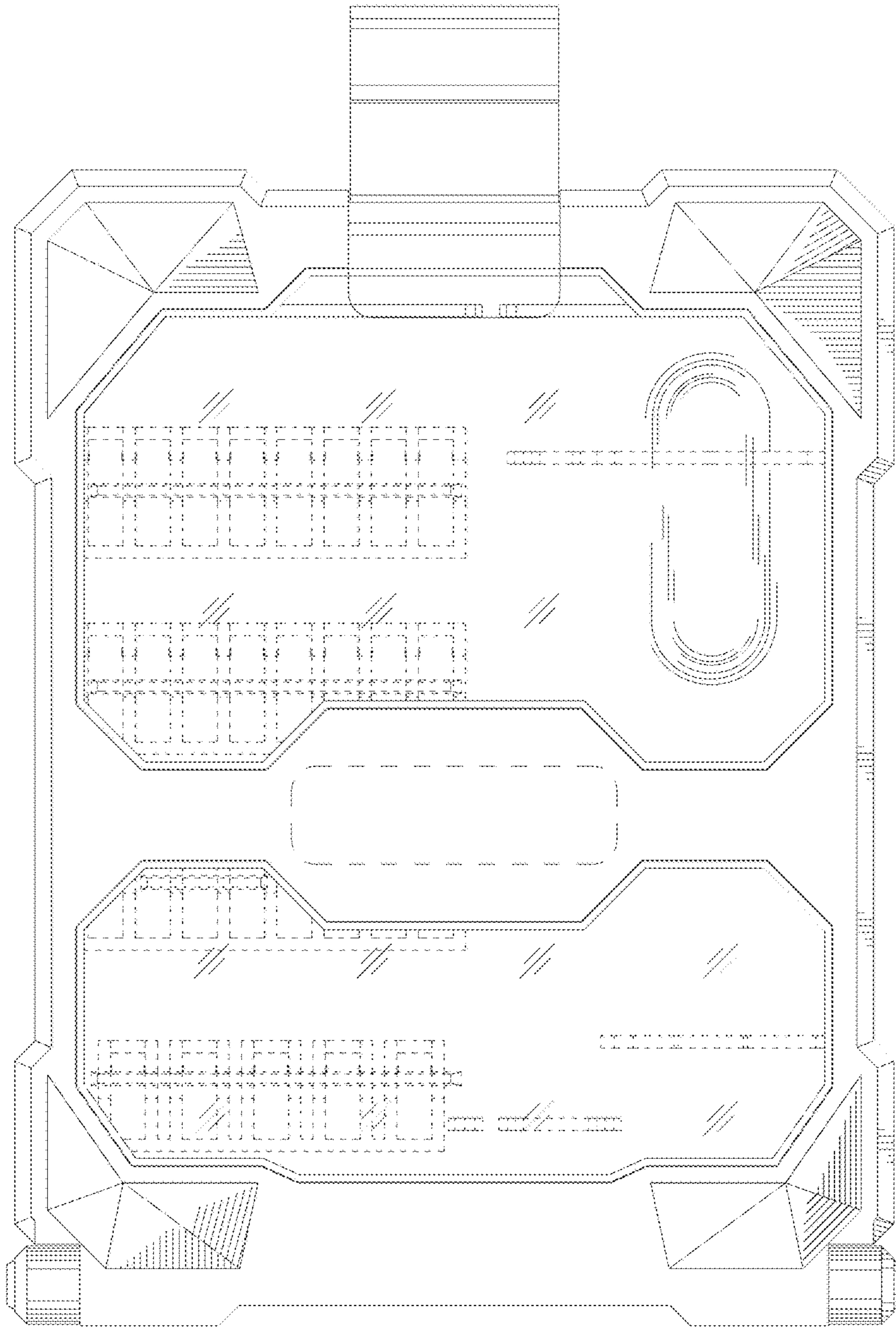

FIG. 18

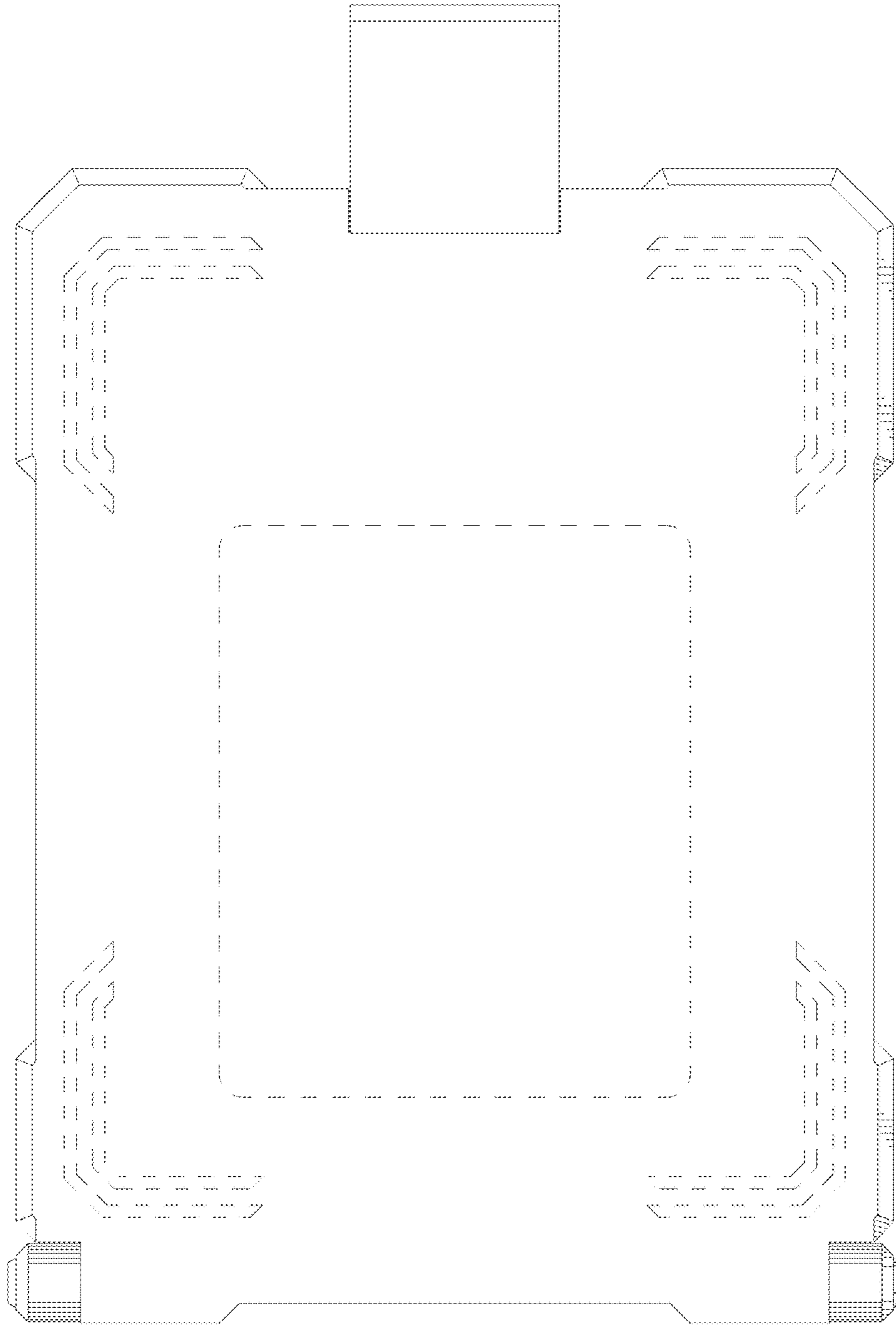

FIG. 19

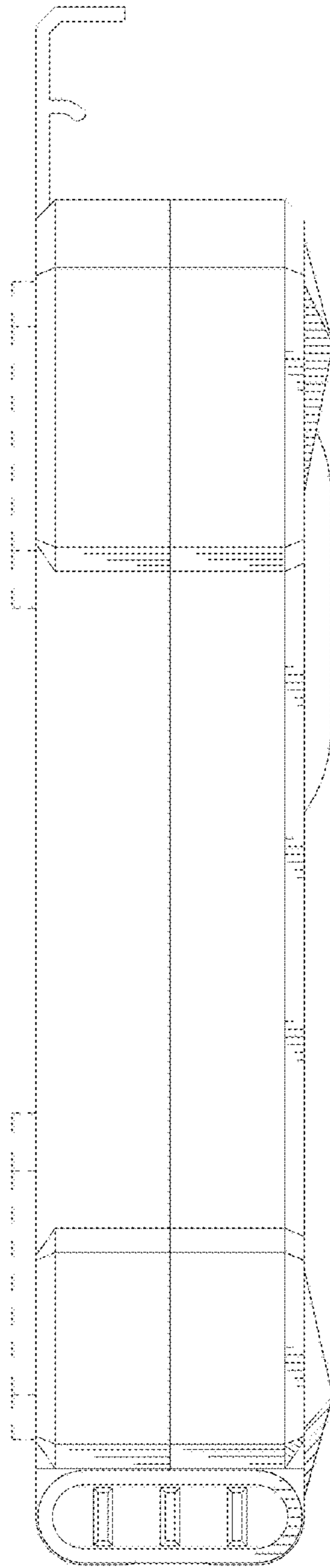

FIG. 20

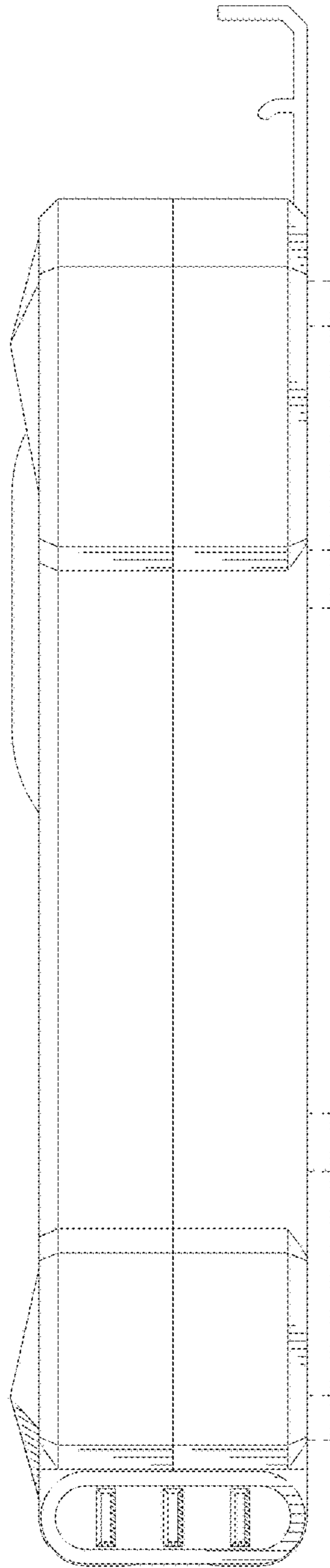

FIG. 21

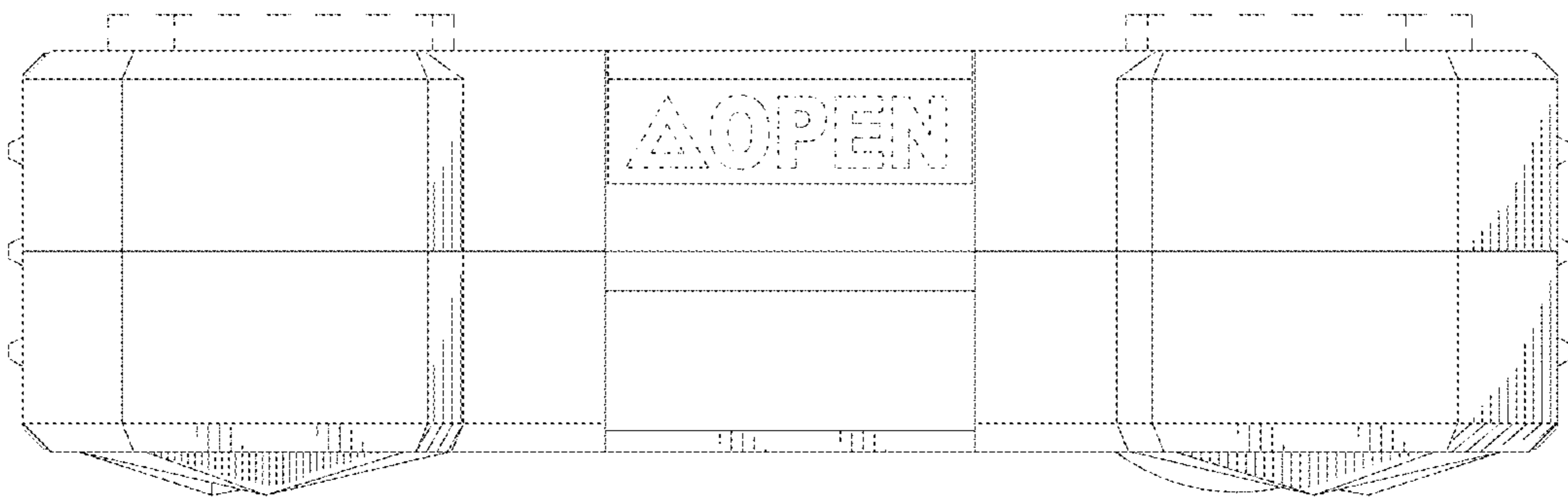

FIG. 22

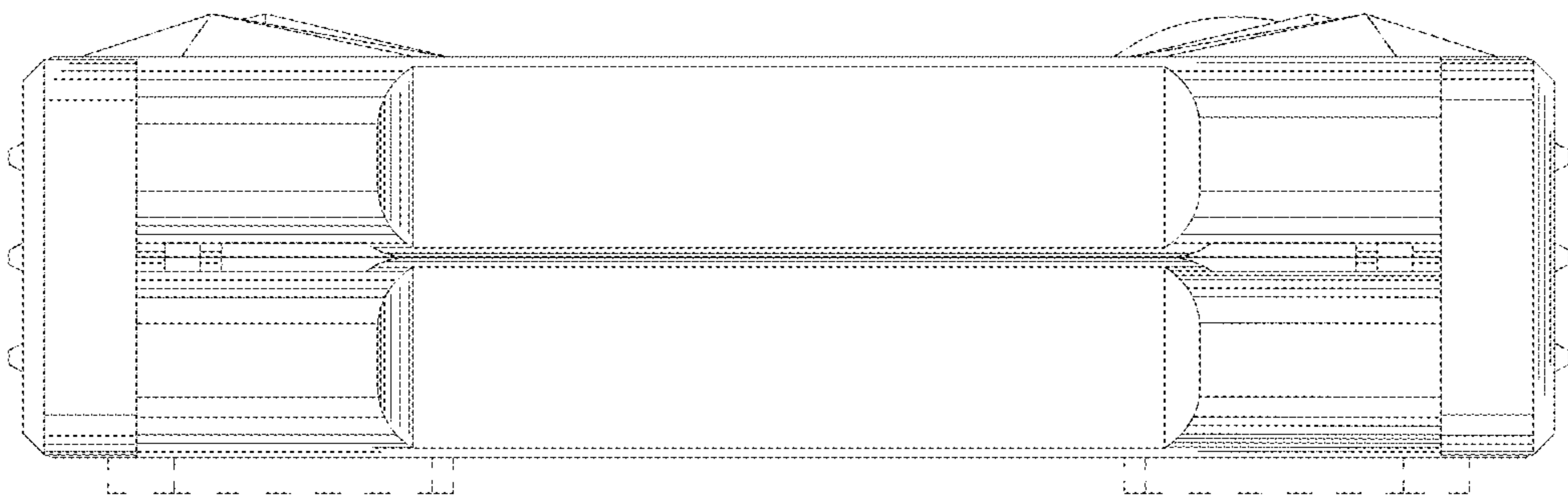

FIG. 23

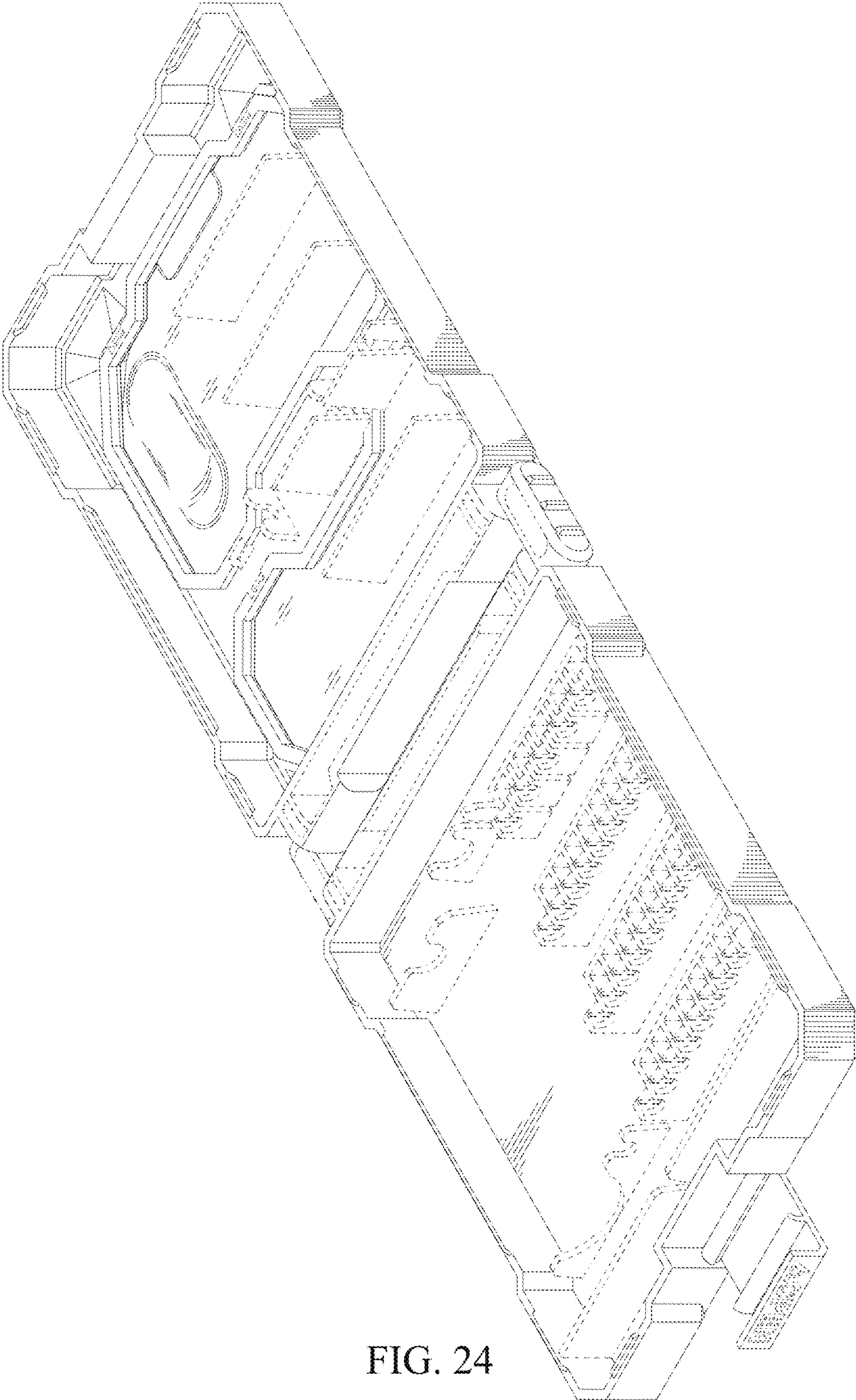

FIG. 24

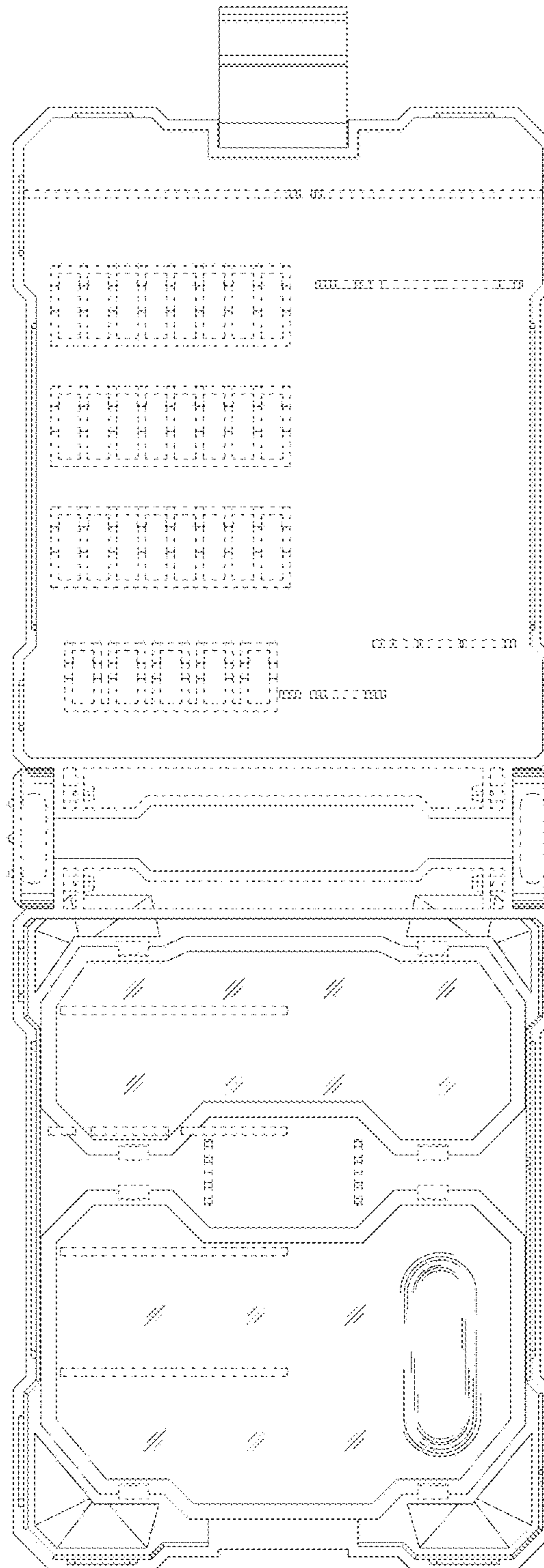

FIG. 25

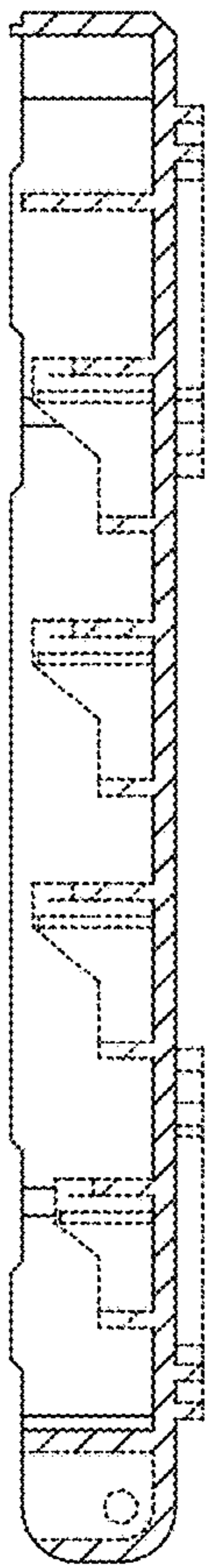

FIG. 27

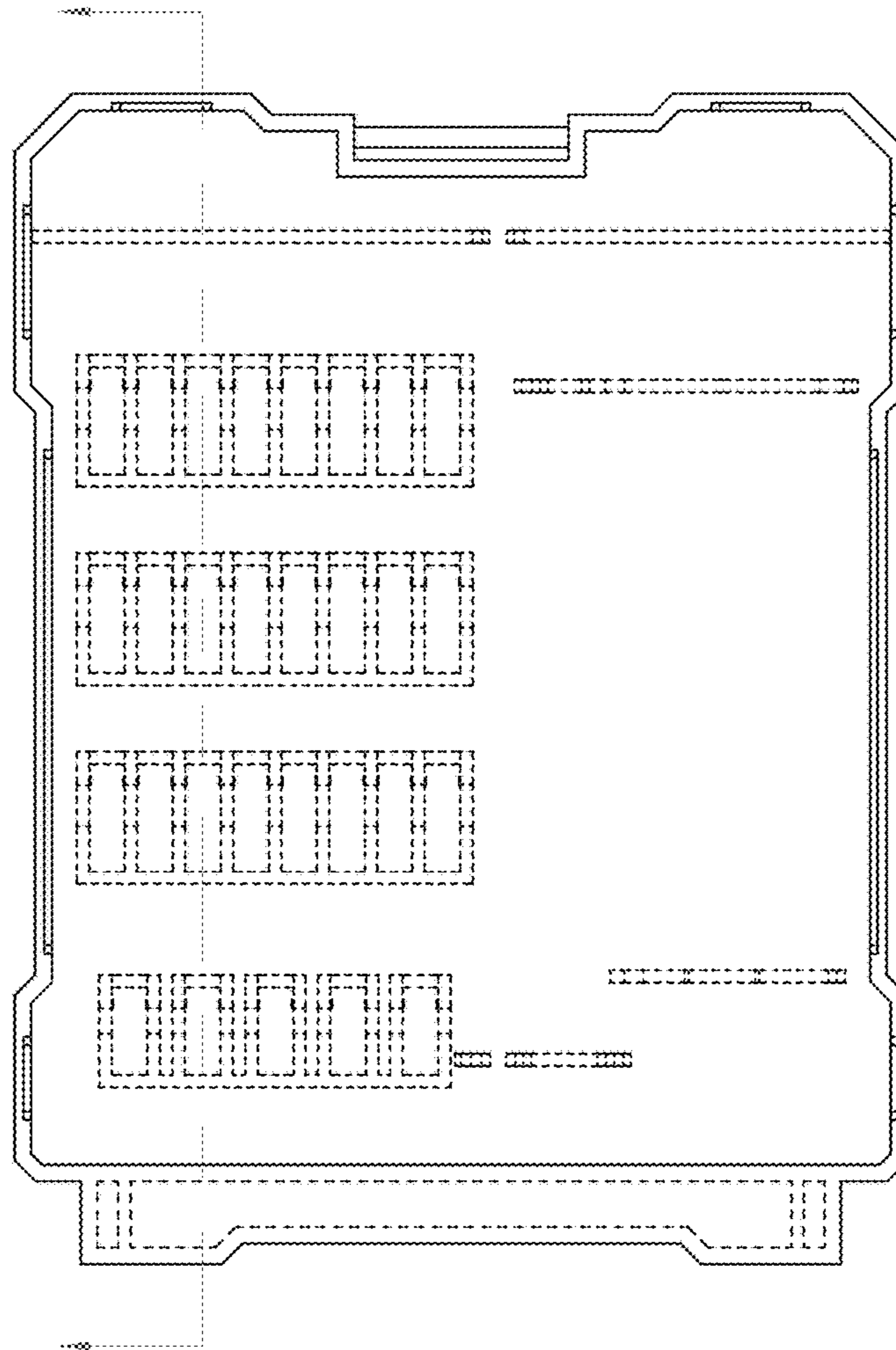

FIG. 26

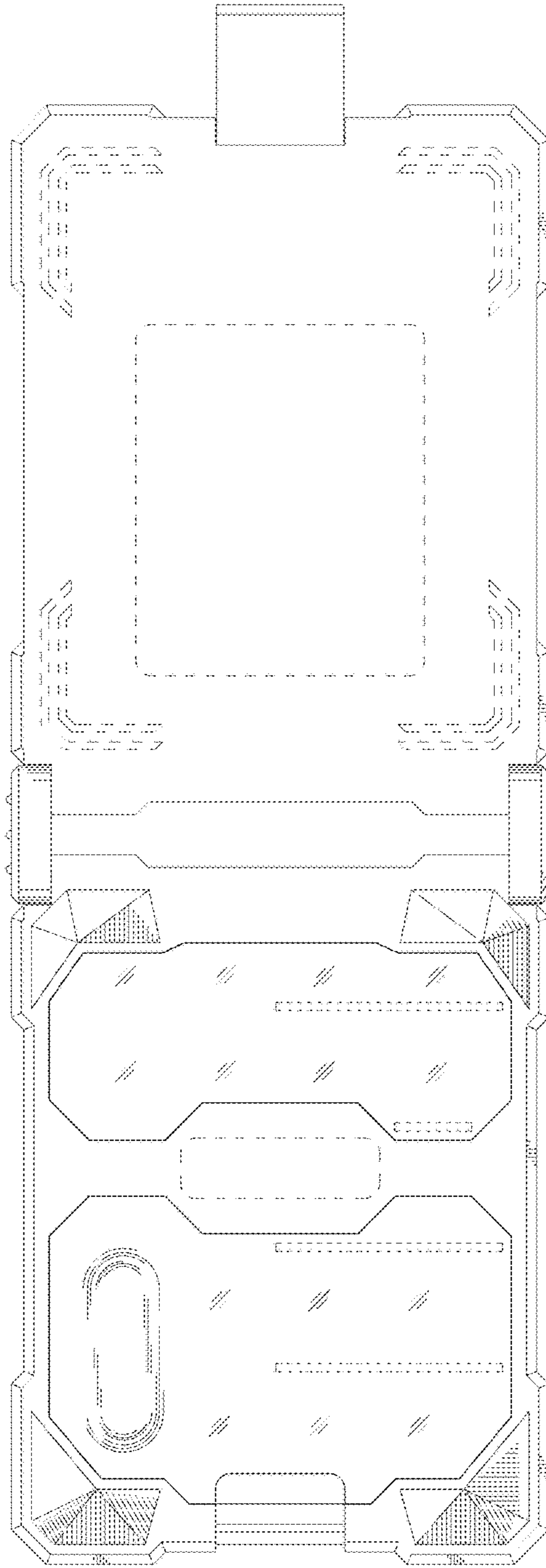

FIG. 28

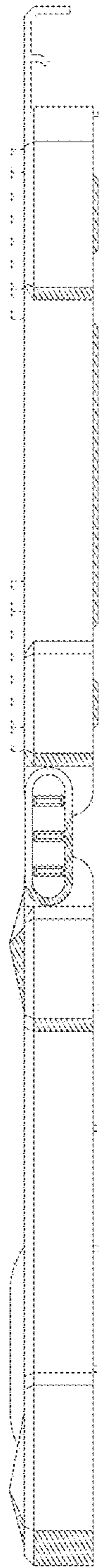

FIG. 29

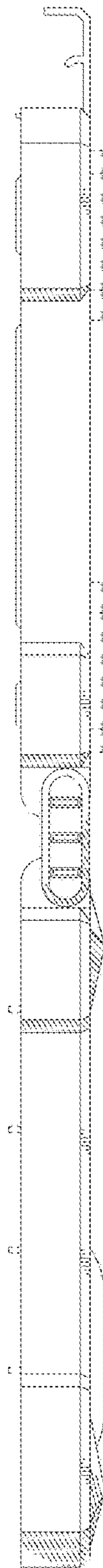

FIG. 30

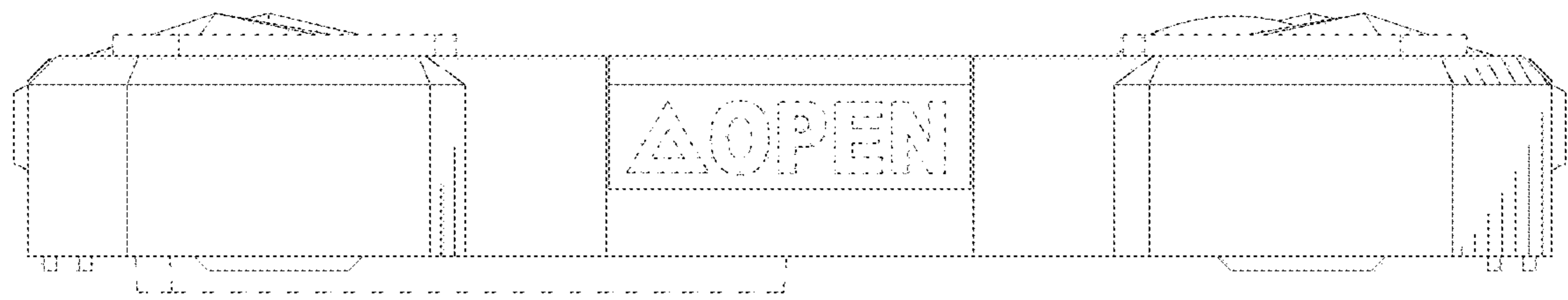

FIG. 31

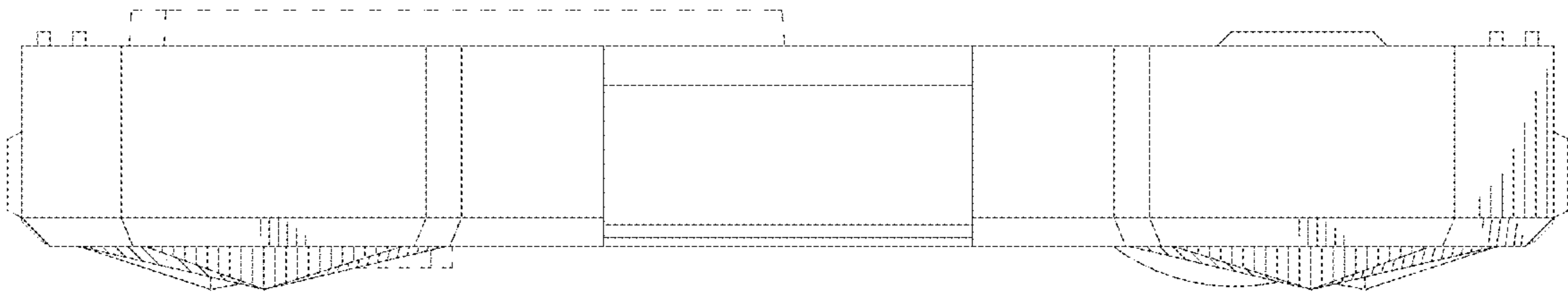

FIG. 32