



US00D848732S

(12) **United States Design Patent**  
**Nix et al.**

(10) **Patent No.:** **US D848,732 S**

(45) **Date of Patent:** **\*\* May 21, 2019**

(54) **HANDBAG**

(71) Applicant: **THE BIG O, LLC**, Dallas, TX (US)

(72) Inventors: **Mary Caroline Nix**, Dallas, TX (US);  
**Jane Dunne Cooke**, Dallas, TX (US)

(73) Assignee: **THE BIG O, LLC**, Dallas, TX (US)

(\*\*) Term: **15 Years**

(21) Appl. No.: **29/632,809**

(22) Filed: **Jan. 10, 2018**

(51) **LOC (11) Cl.** ..... **03-01**

(52) **U.S. Cl.**  
USPC ..... **D3/232**

(58) **Field of Classification Search**  
USPC ..... D3/232-233, 240-243, 245-246  
CPC ..... A45C 1/024; A45C 3/06  
See application file for complete search history.

(56) **References Cited**

**U.S. PATENT DOCUMENTS**

D621,610 S \* 8/2010 Parsley ..... D3/232  
D693,117 S \* 11/2013 Maier ..... D3/232

D742,635 S \* 11/2015 Coleman ..... D3/232  
D811,732 S \* 3/2018 Barclay et al. .... D3/232  
D811,733 S \* 3/2018 Barclay et al. .... D3/232

\* cited by examiner

*Primary Examiner* — Holly H Baynham

(74) *Attorney, Agent, or Firm* — Haynes and Boone, LLP

(57) **CLAIM**

The ornamental design for a handbag, as shown and described.

**DESCRIPTION**

FIG. 1 is a perspective view of a handbag showing our new design;  
FIG. 2 is a front elevational view thereof;  
FIG. 3 is a rear elevational view thereof;  
FIG. 4 is a right side elevational view thereof;  
FIG. 5 is a left side elevational view thereof;  
FIG. 6 is a top plan view thereof;  
FIG. 7 is a bottom plan view thereof;  
FIG. 8 is another perspective view thereof; and,  
FIG. 9 is yet another perspective view thereof.

**1 Claim, 7 Drawing Sheets**

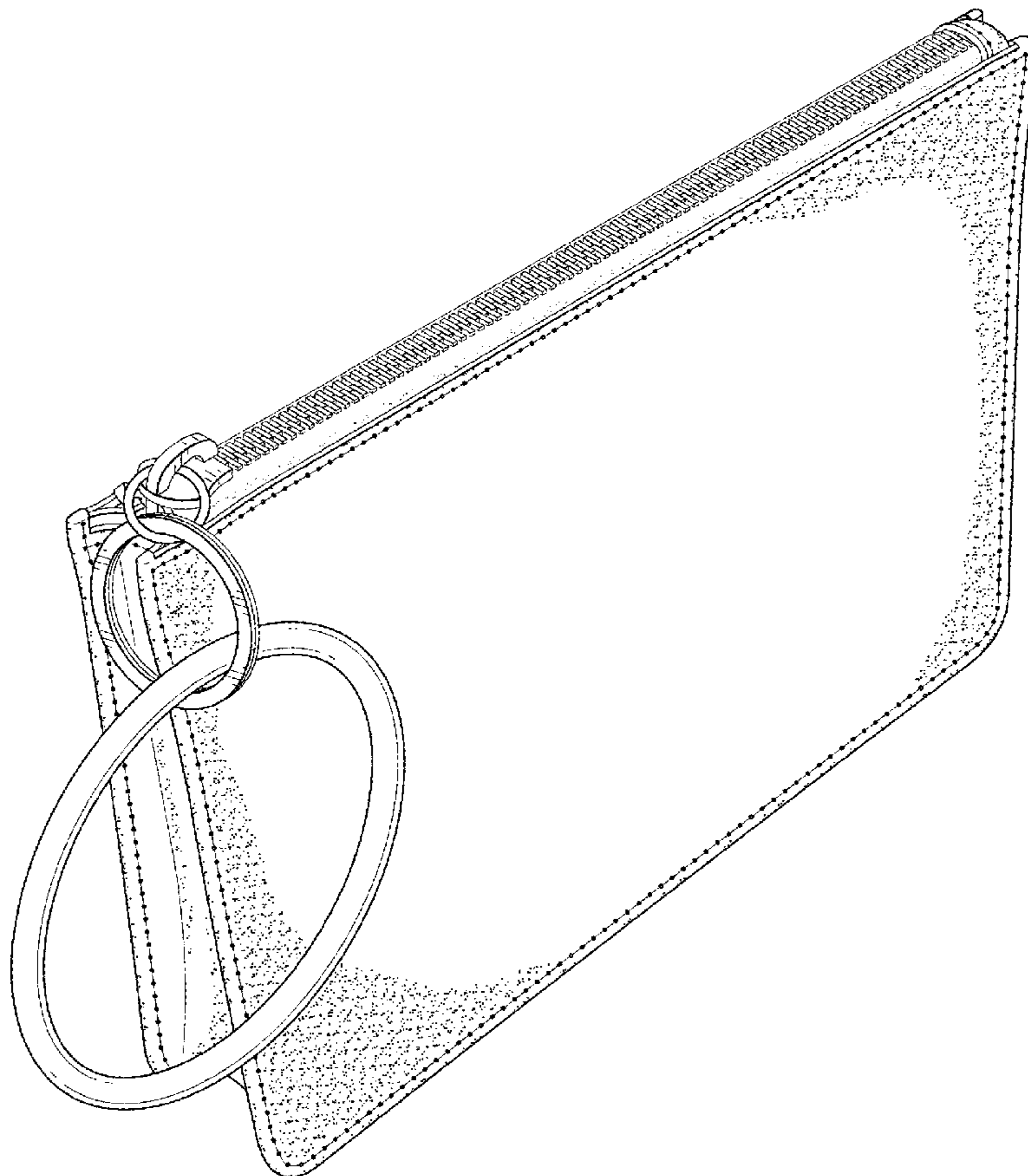

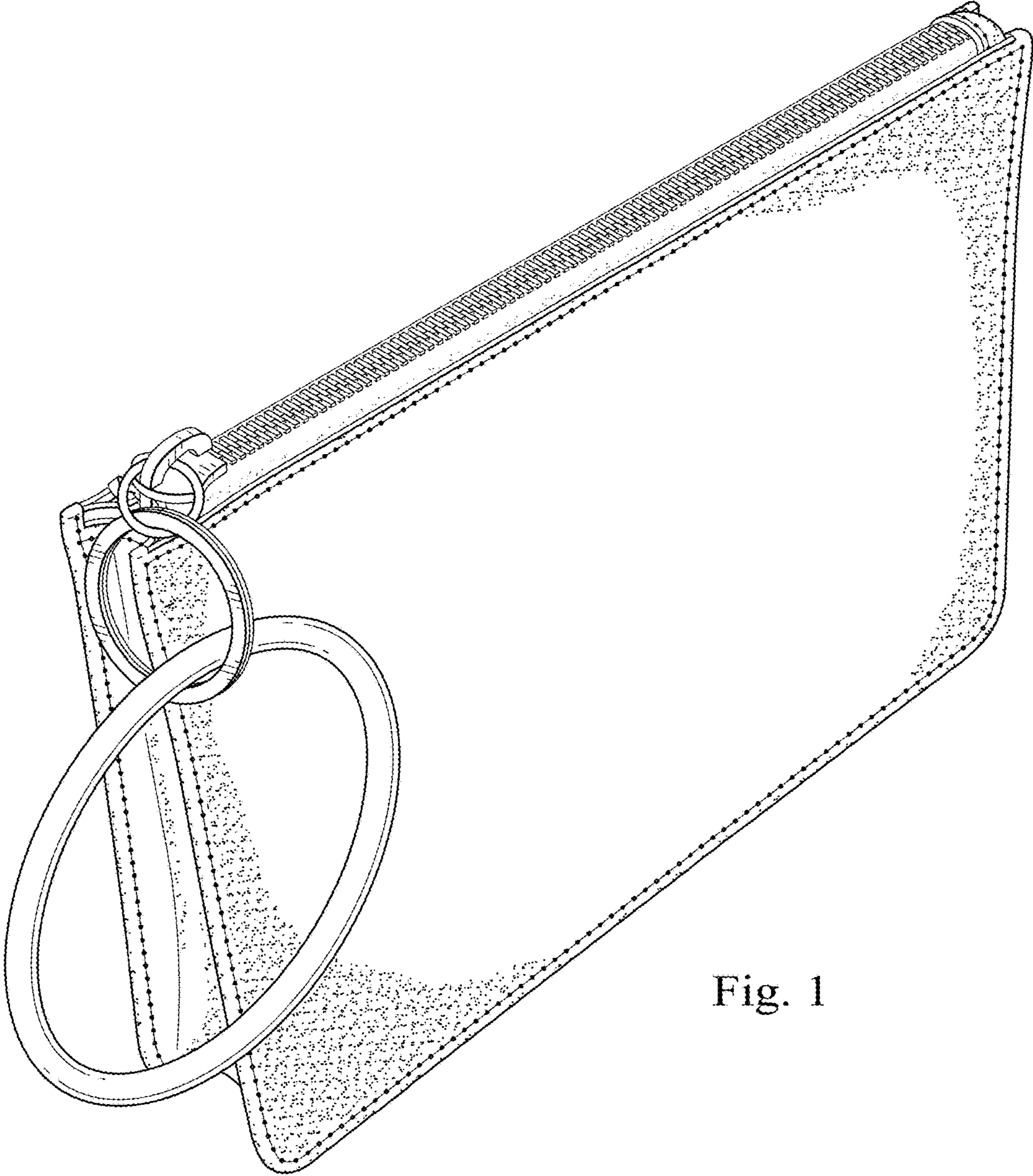

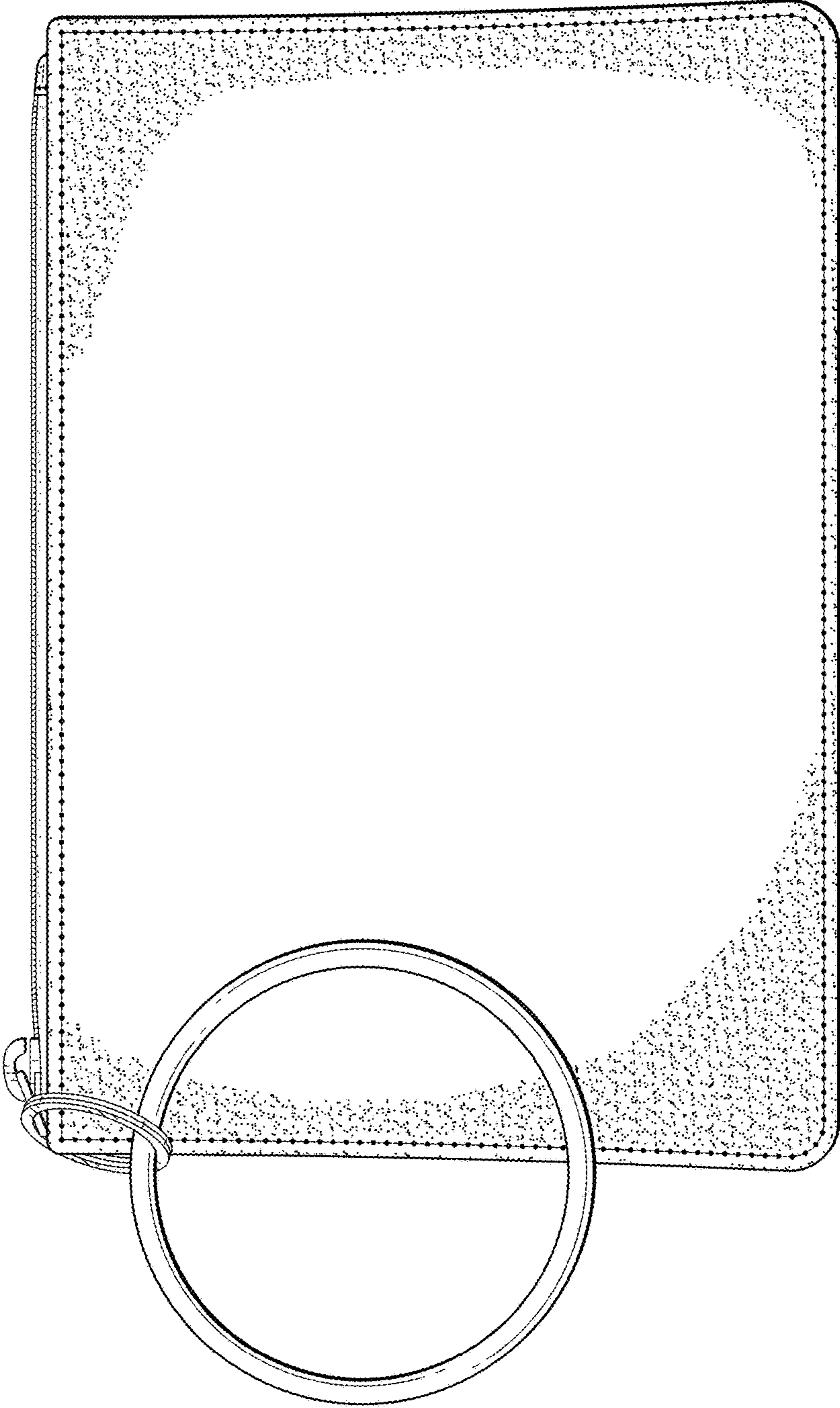

Fig. 2



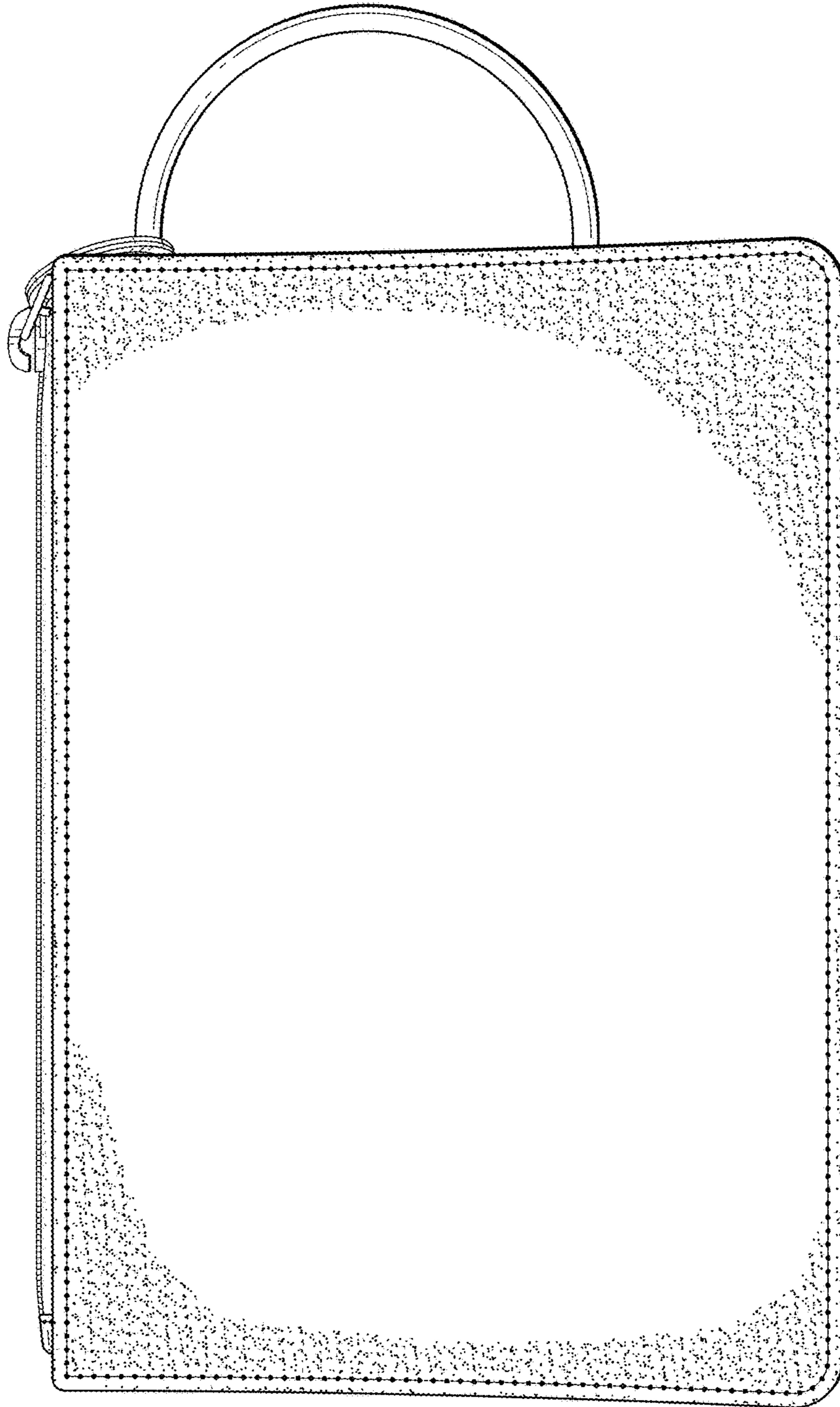

Fig. 3

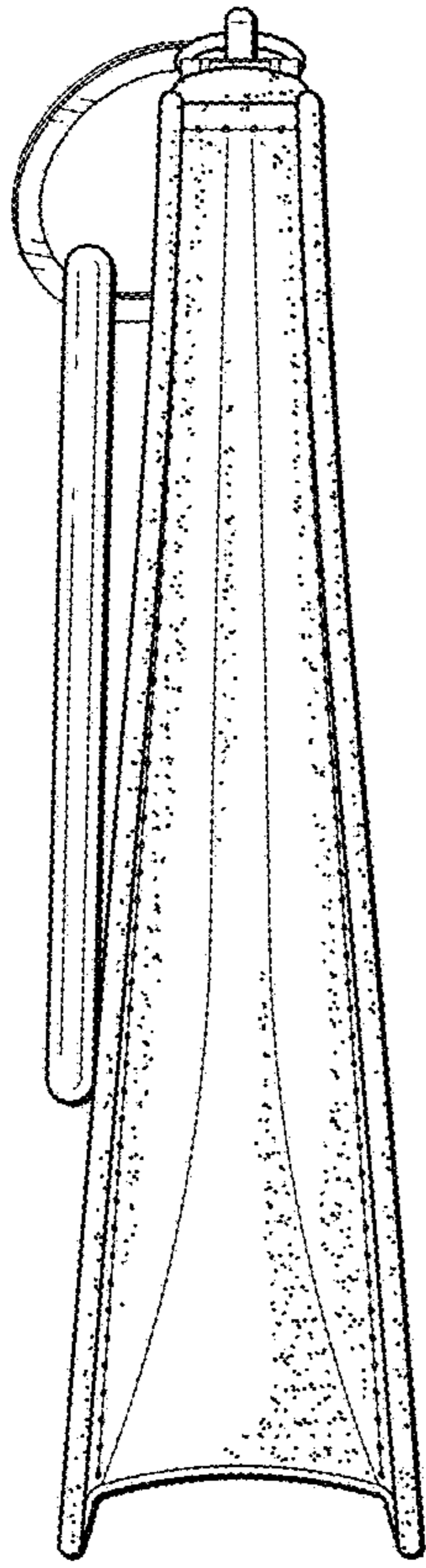

Fig. 4

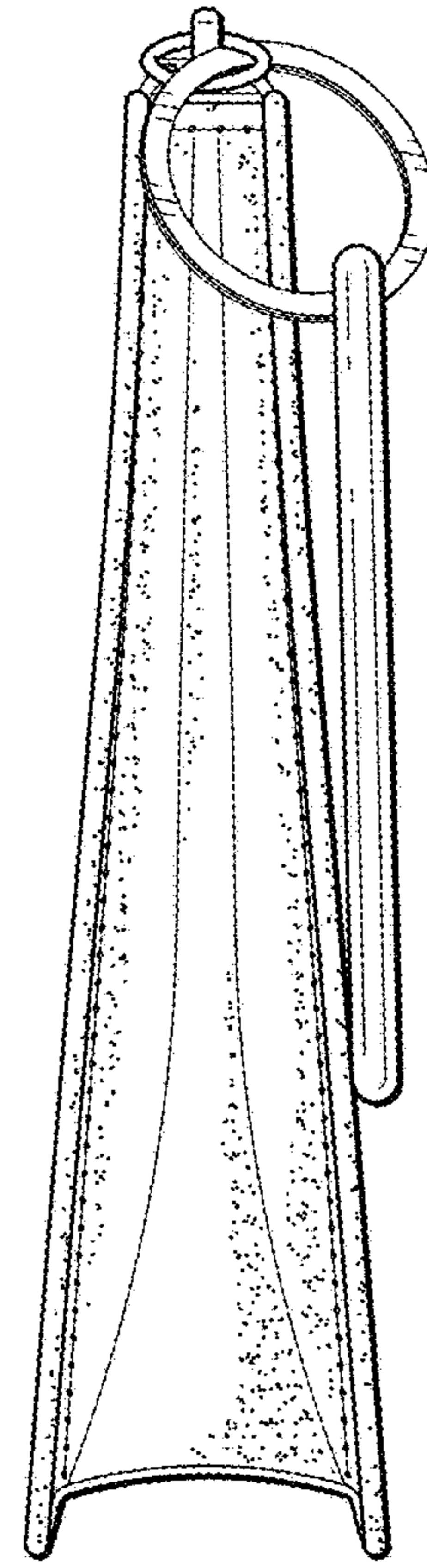

Fig. 5

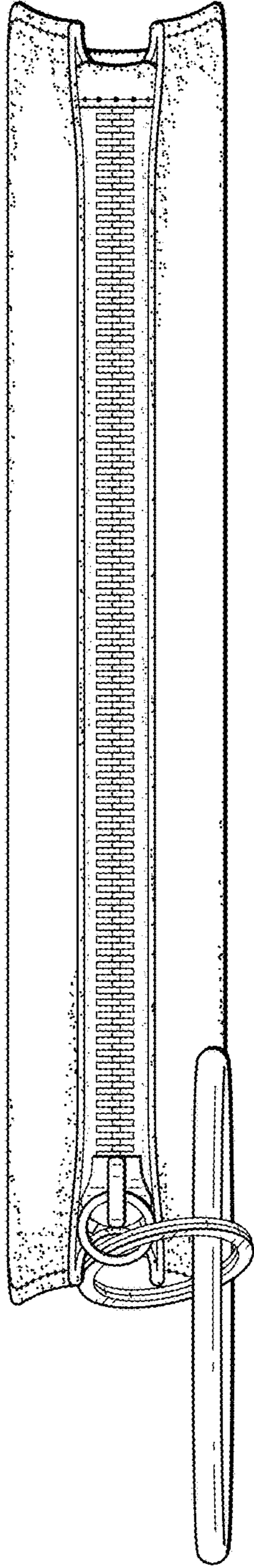

Fig. 6

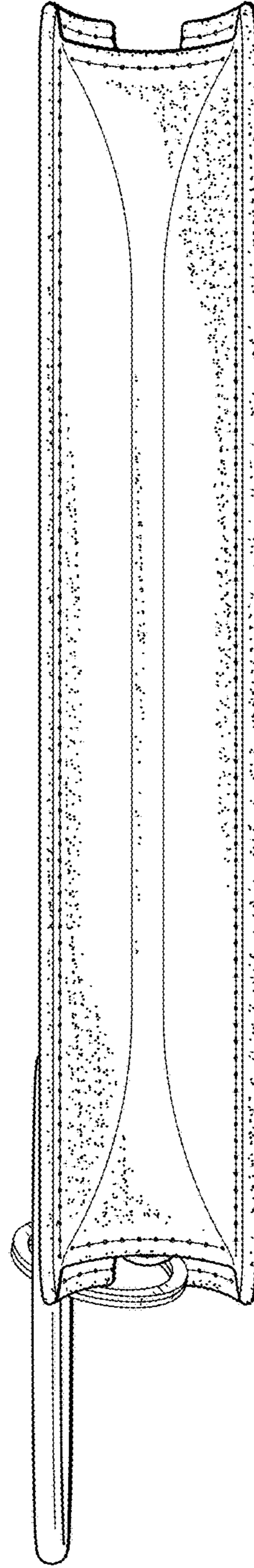

Fig. 7

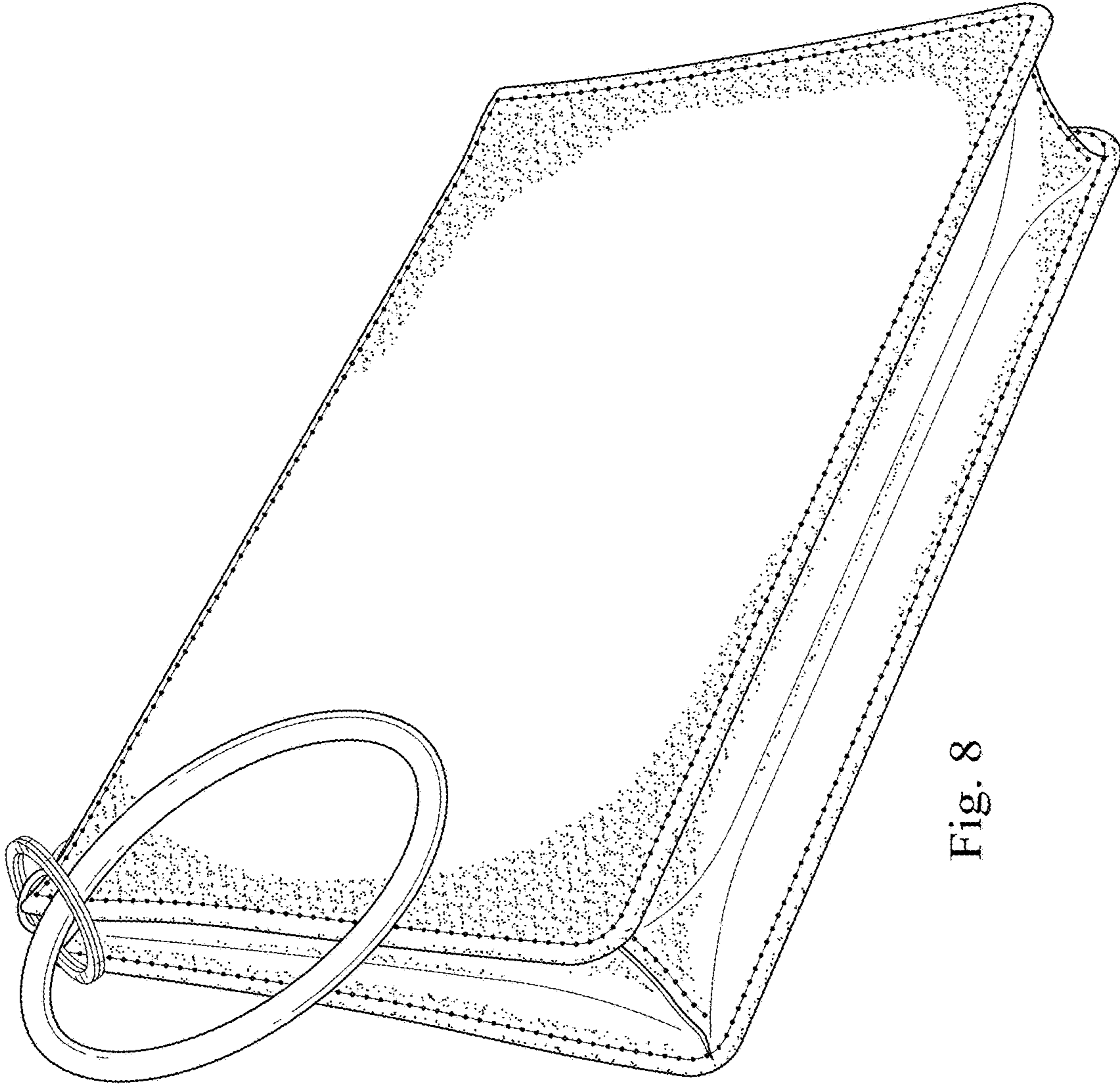

Fig. 8



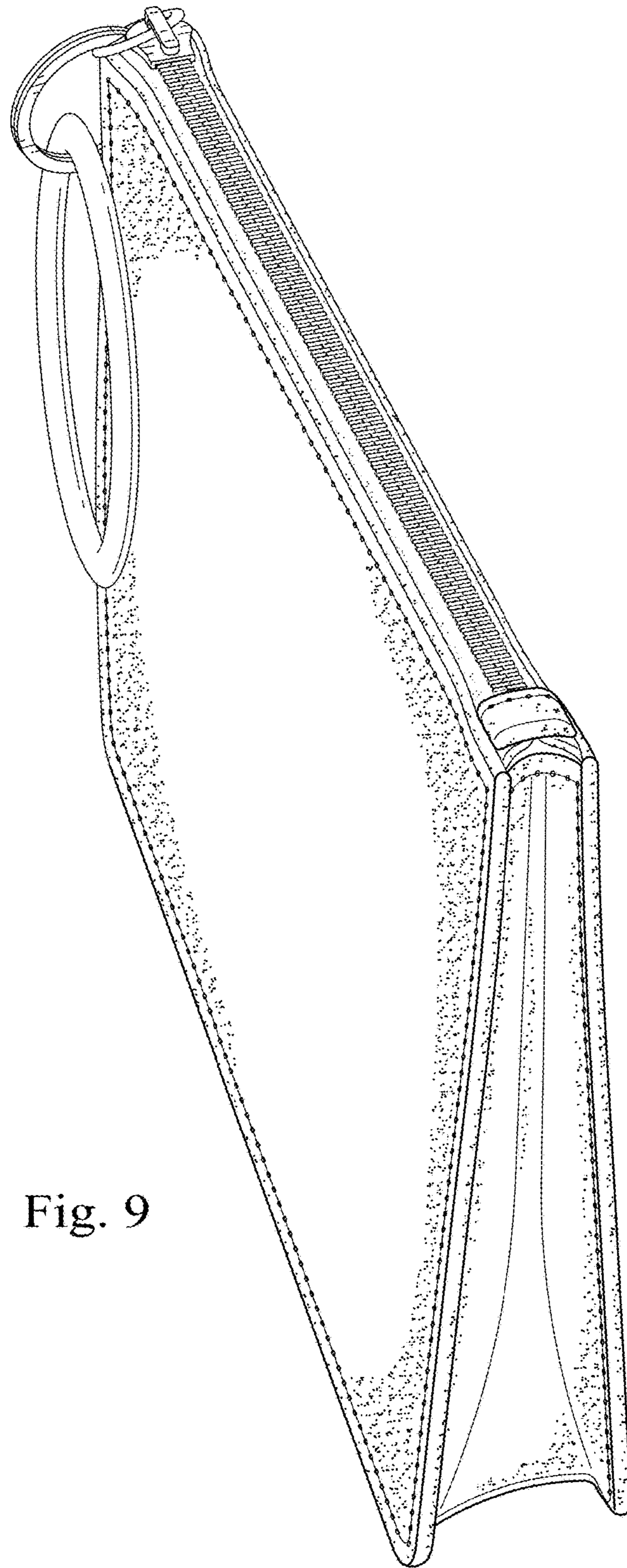

Fig. 9



UNITED STATES PATENT AND TRADEMARK OFFICE  
**CERTIFICATE OF CORRECTION**

PATENT NO. : D848,732 S  
APPLICATION NO. : 29/632809  
DATED : May 21, 2019  
INVENTOR(S) : Mary Caroline Nix and Jane Dunne Cooke

Page 1 of 1

It is certified that error appears in the above-identified patent and that said Letters Patent is hereby corrected as shown below:

On the Title Page

Item (57), please add the following statement:

-- Cross-Reference to Related Applications

This application is related to U.S. Patent Application No. 29/632,812, filed January 10, 2018 bearing Attorney Docket No. 52815.27US01, the entire disclosure of which is hereby incorporated herein by reference.

This application is related to U.S. Patent Application No. 62/615,611, filed January 10, 2018 bearing Attorney Docket No. 52815.28PV01, the entire disclosure of which is hereby incorporated herein by reference. --

Signed and Sealed this  
Twentieth Day of August, 2019

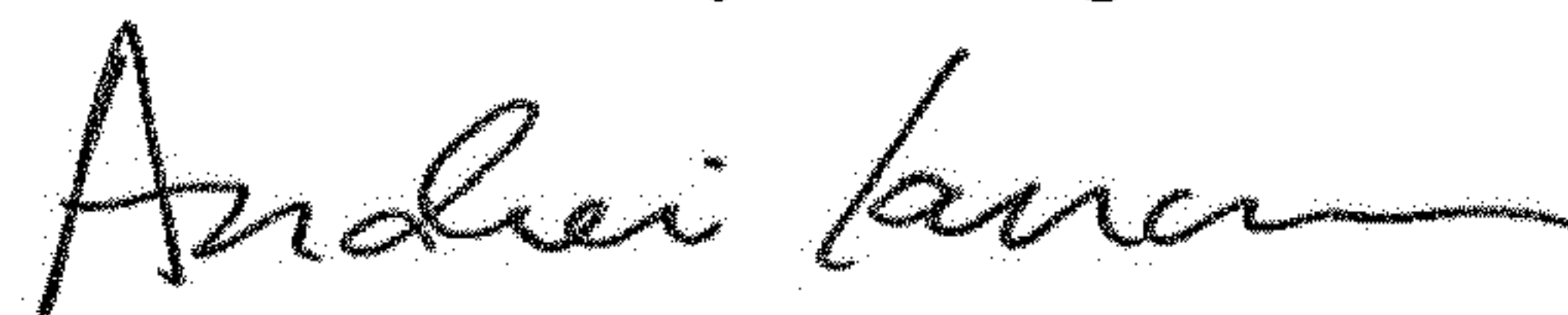

Andrei Iancu  
*Director of the United States Patent and Trademark Office*