



US00D848699S

(12) **United States Design Patent** (10) **Patent No.:** **US D848,699 S**  
**Busch** (45) **Date of Patent:** **\*\* May 14, 2019**

(54) **CONTAINER**  
(71) Applicant: **BUSCH SYSTEMS INTERNATIONAL INC.**, Barrie (CA)  
(72) Inventor: **Craig Busch**, Barrie (CA)  
(73) Assignee: **BUSCH SYSTEMS INTERNATIONAL INC.**, Barrie (CA)  
(\*\*) Term: **15 Years**  
(21) Appl. No.: **29/666,262**  
(22) Filed: **Oct. 11, 2018**

D327,348 S 6/1992 Skorheim  
5,181,297 A 1/1993 Andrews, Jr. et al.  
5,476,187 A 12/1995 Marisco  
5,577,628 A \* 11/1996 O'Neil ..... A45C 13/005  
220/840  
D378,153 S \* 2/1997 Freedland ..... D34/1  
D410,124 S \* 5/1999 Nilsson ..... D34/1  
D447,304 S \* 8/2001 Niemeyer ..... D34/1

(Continued)

*Primary Examiner* — Cynthia Ramirez  
*Assistant Examiner* — Michael A Maharajh  
(74) *Attorney, Agent, or Firm* — Marshall, Gerstein & Borun LLP

**Related U.S. Application Data**

(62) Division of application No. 29/579,546, filed on Sep. 30, 2016, now Pat. No. Des. 835,373.

(51) **LOC (11) Cl.** ..... **09-09**

(52) **U.S. Cl.**  
USPC ..... **D34/7**

(58) **Field of Classification Search**  
USPC ..... D34/1, 2, 3, 4, 5, 6, 7, 8, 9, 10, 11, 37, D34/39; D6/403; D9/737, 738, 770, D9/772, 778, 781; D11/143; D19/77, D19/99; D23/202, 203, 205; 220/211, 220/4.04, 484, 495.08, 569, 62.12, 62.13, 220/703, 737, 748, 908.1, 908.2, 908, 220/909, 495.09, 810, 495.06  
CPC ..... A47G 19/2205; A47G 19/23; B65D 2543/00194  
See application file for complete search history.

(56) **References Cited**

**U.S. PATENT DOCUMENTS**

D275,618 S 9/1984 Agard  
D319,123 S \* 8/1991 DeRewal ..... D34/5  
D324,121 S \* 2/1992 Schierlinger ..... D34/1  
5,101,997 A \* 4/1992 Bagwell ..... B65F 1/0066  
D34/5

(57) **CLAIM**

The ornamental design for a container, as shown and described.

**DESCRIPTION**

FIG. 1 is a perspective view of a container showing a first variant of the design;  
FIG. 2 is a front view thereof;  
FIG. 3 is a rear view thereof;  
FIG. 4 is a left side view thereof;  
FIG. 5 is a right side view thereof;  
FIG. 6 is a top view thereof;  
FIG. 7 is a bottom view thereof;  
FIG. 8 is a perspective view of a container showing a second variant of the design;  
FIG. 9 is a front view thereof;  
FIG. 10 is a rear view thereof;  
FIG. 11 is a left side view thereof;  
FIG. 12 is a right side view thereof;  
FIG. 13 is a top view thereof; and,  
FIG. 14 is a bottom view thereof.

The broken lines shown in the figures are for the purpose of illustrating portions of the container, which form no part of the claimed design.

**1 Claim, 10 Drawing Sheets**

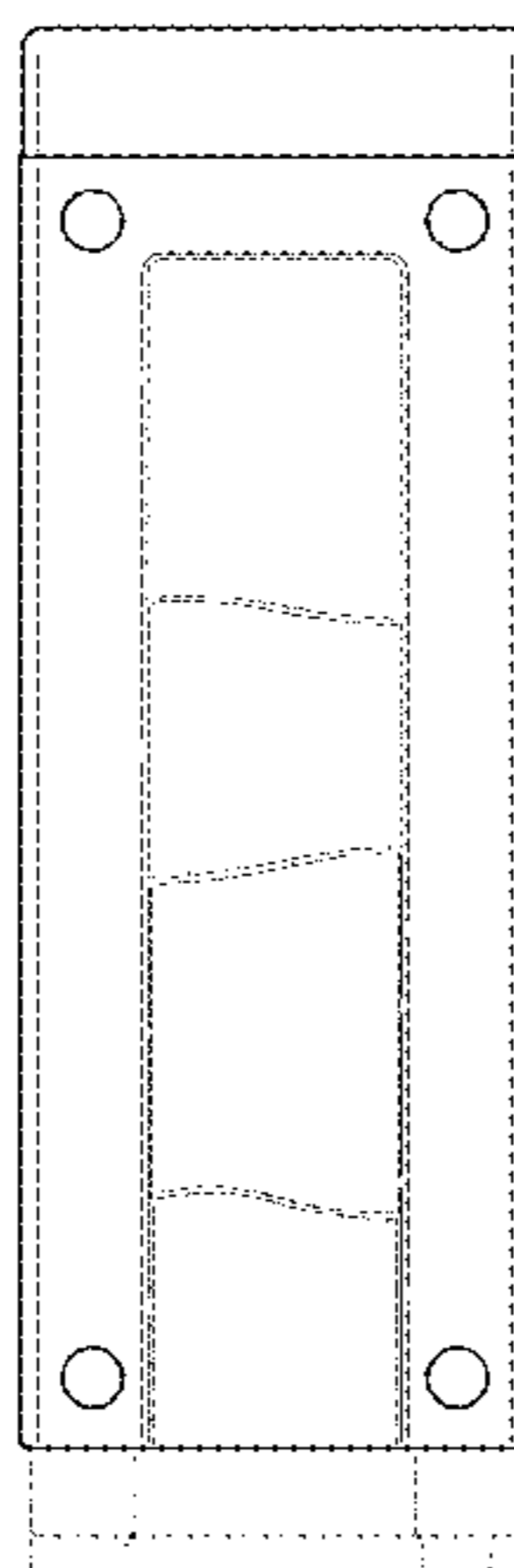

(56)

**References Cited**

U.S. PATENT DOCUMENTS

6,626,317 B2 \* 9/2003 Pfiefer ..... B65F 1/16  
220/263  
D556,054 S \* 11/2007 Stephens ..... D9/734  
D573,917 S \* 7/2008 Bigoski ..... D11/143  
D580,613 S 11/2008 Yang et al.  
D618,415 S \* 6/2010 Greseth ..... D34/1  
D644,806 S \* 9/2011 Yang ..... D34/1  
D730,007 S 5/2015 Machen  
D758,037 S 5/2016 Madrid  
D761,154 S \* 7/2016 Agar ..... D11/143  
D770,296 S 11/2016 Rothfos  
D811,035 S \* 2/2018 Lavoie ..... D34/1  
D825,876 S \* 8/2018 Chen ..... D34/1  
2009/0250471 A1 10/2009 Askonen  
2015/0060460 A1 3/2015 Corbitt  
2016/0167858 A1 6/2016 Sanfilippo et al.

\* cited by examiner

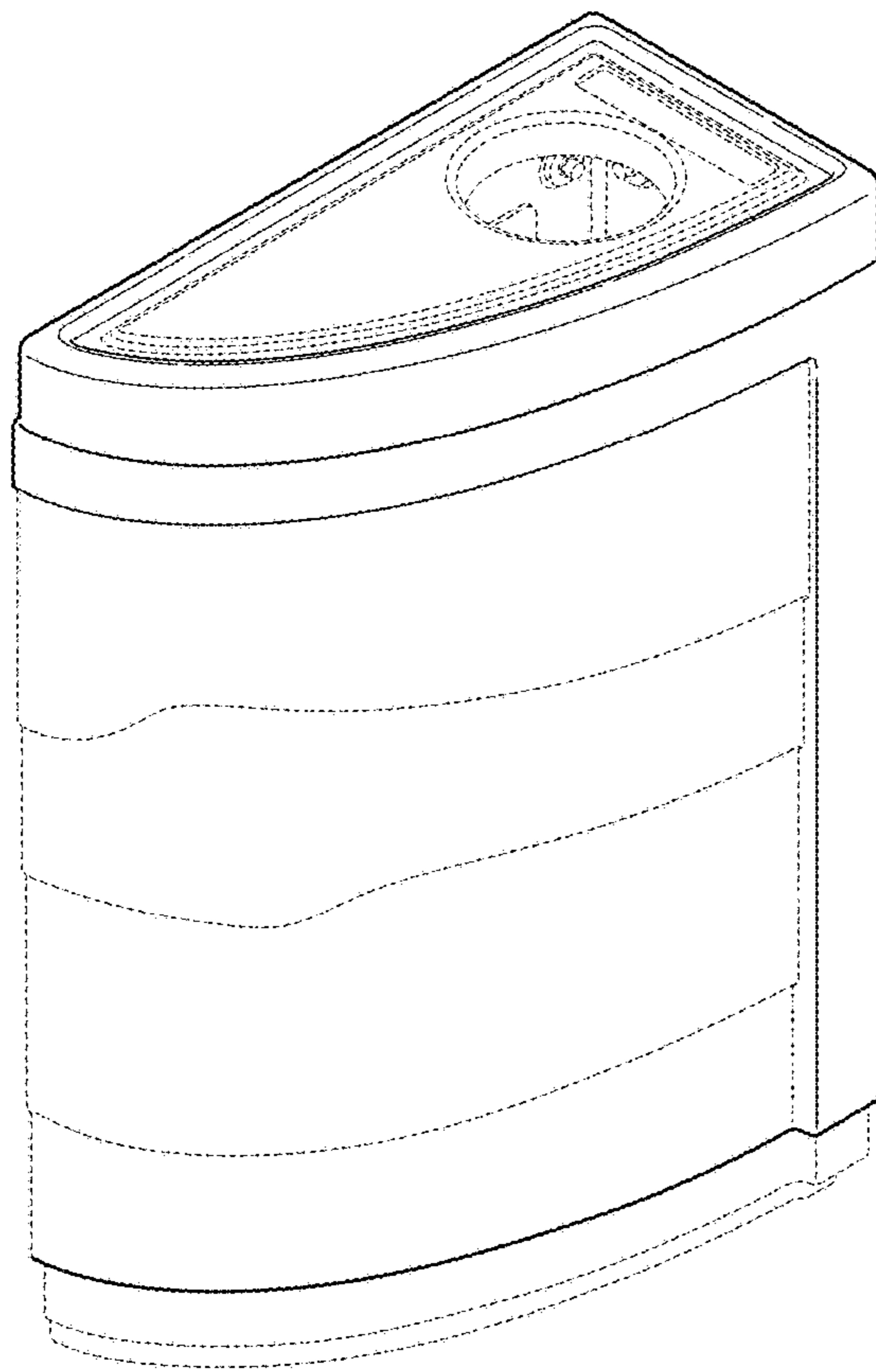

**FIG. 1**

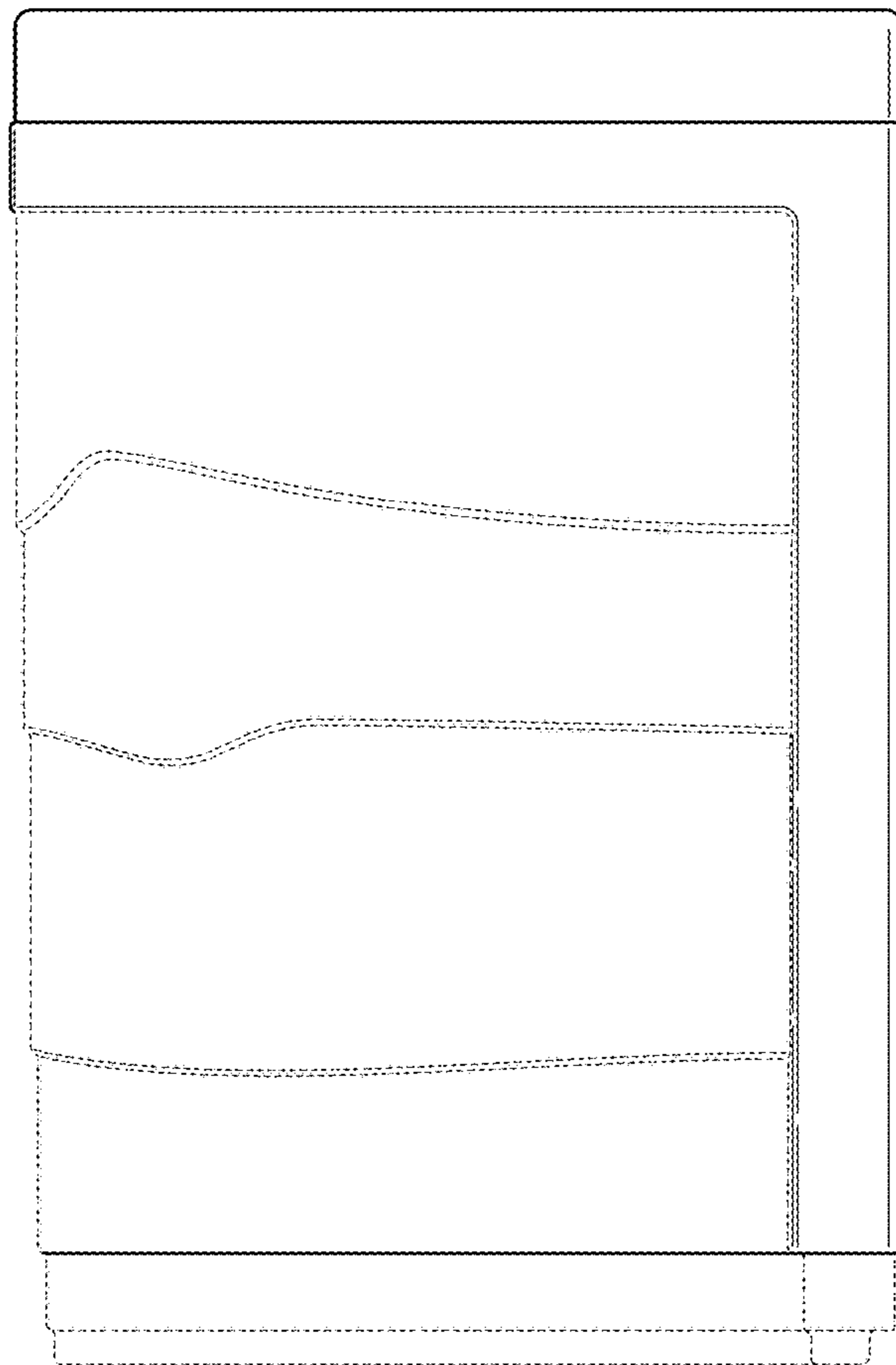

FIG. 2

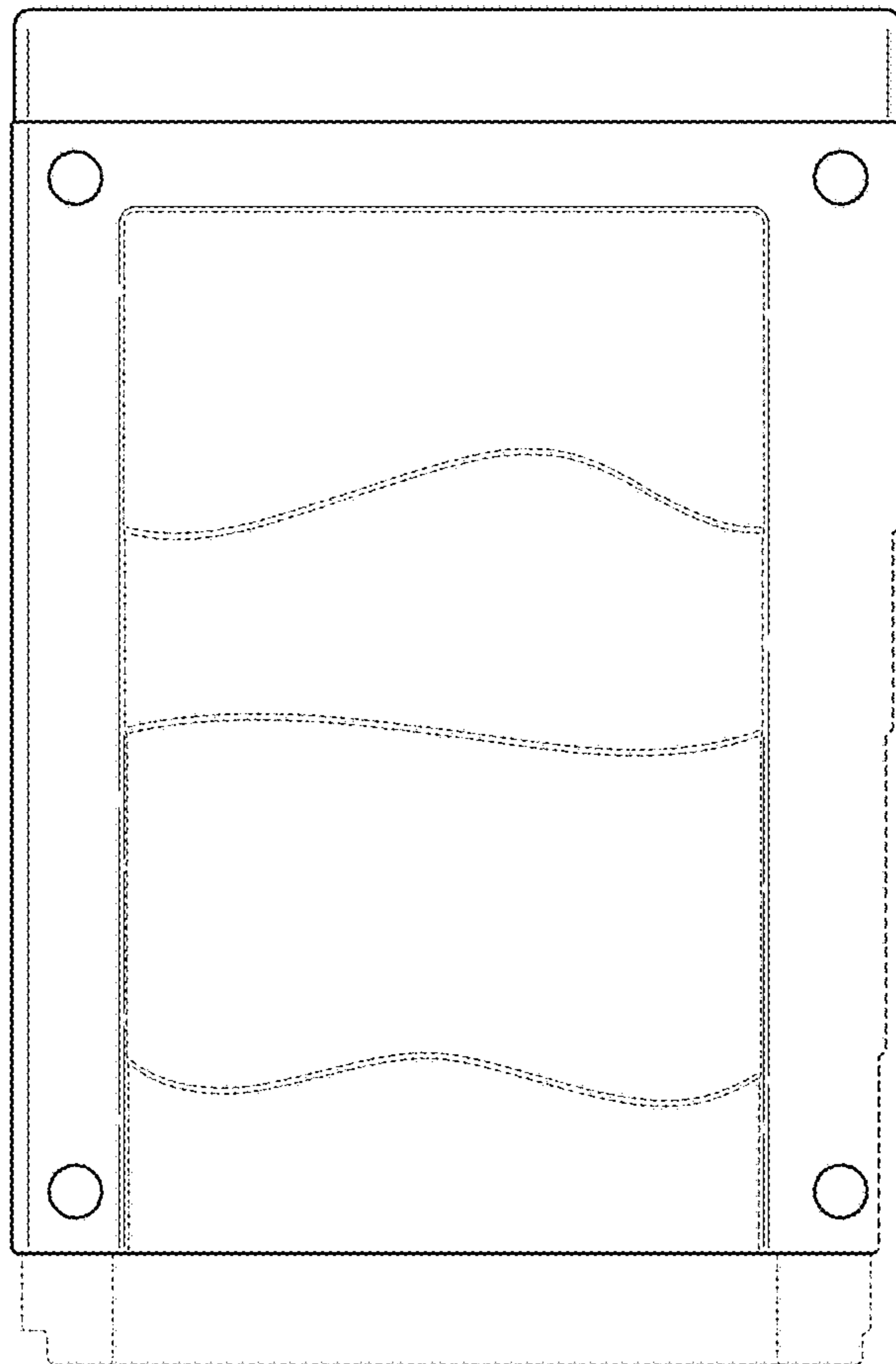

FIG. 3

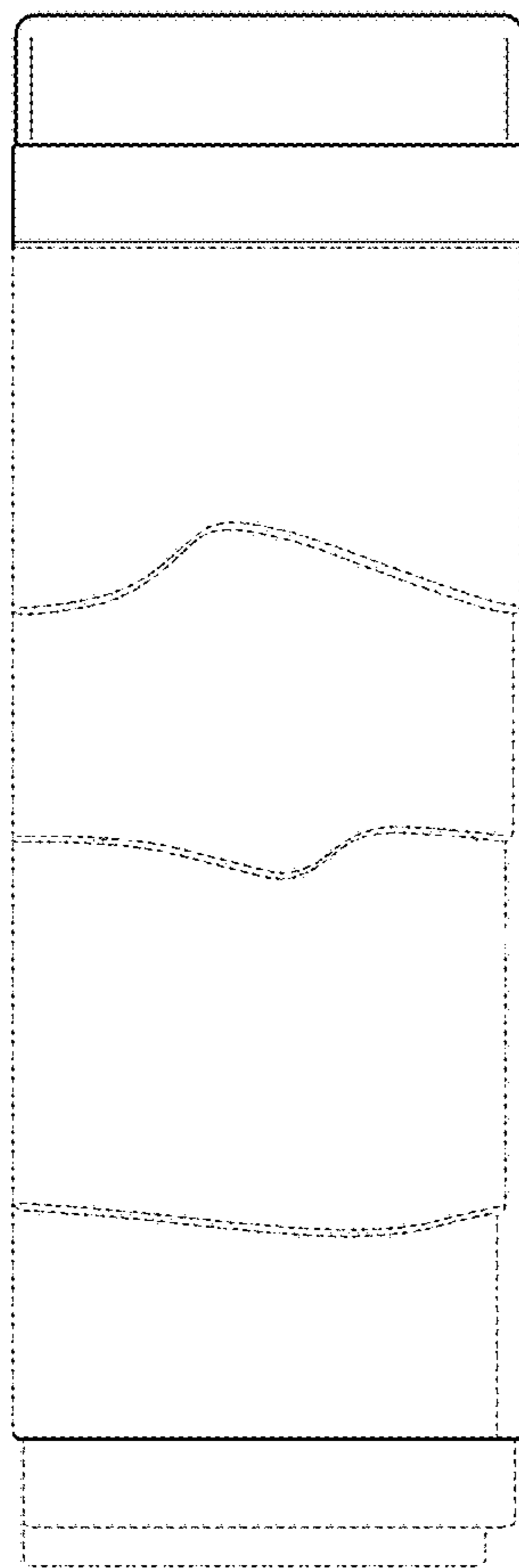

FIG. 4

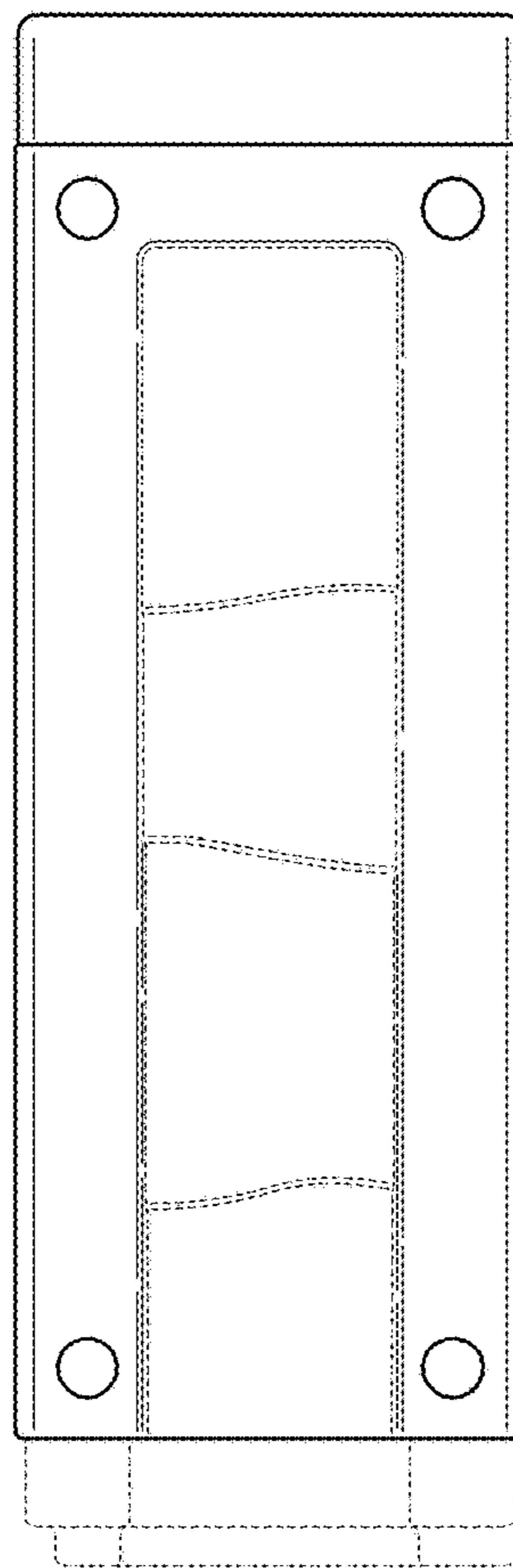

FIG. 5

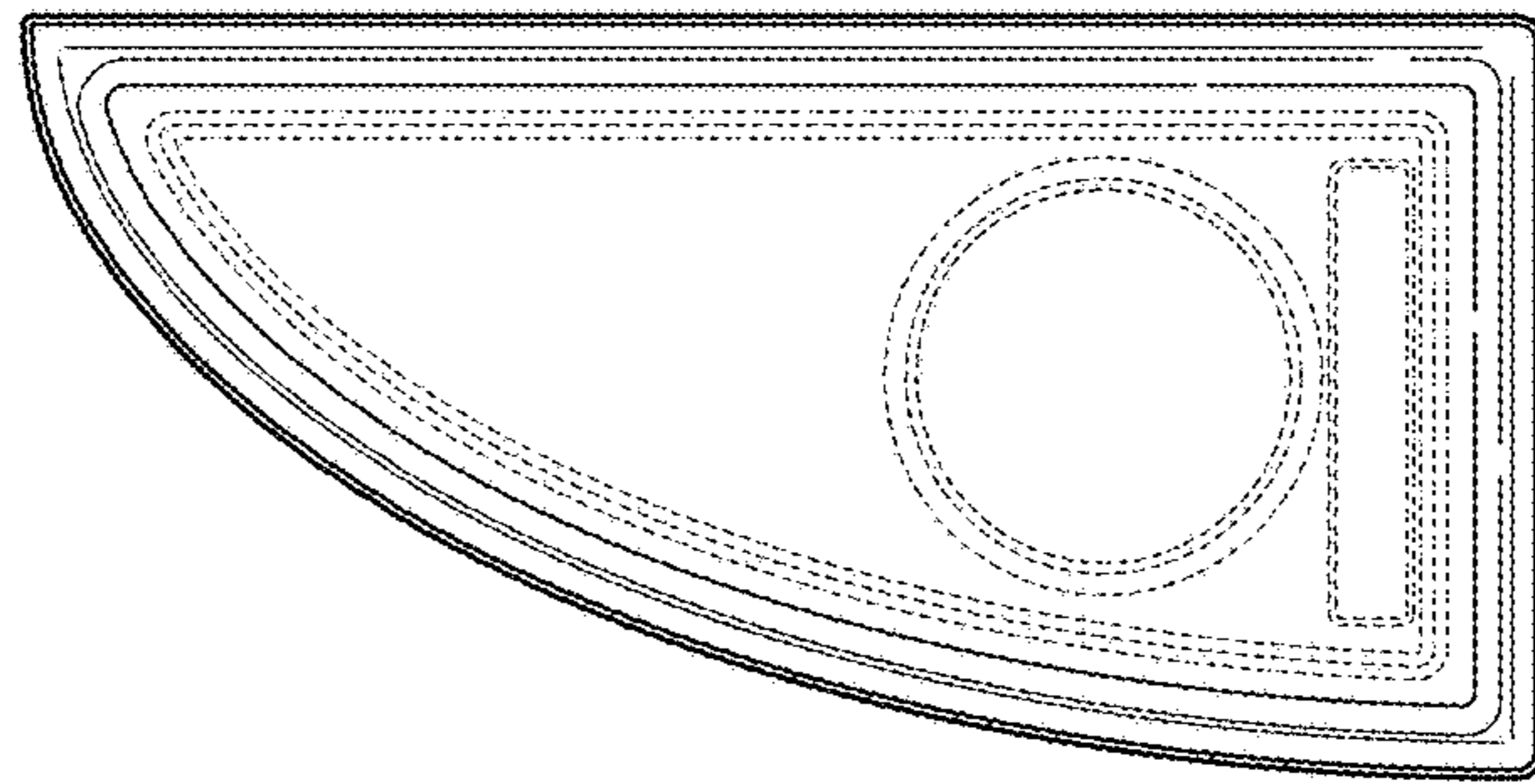

FIG. 6

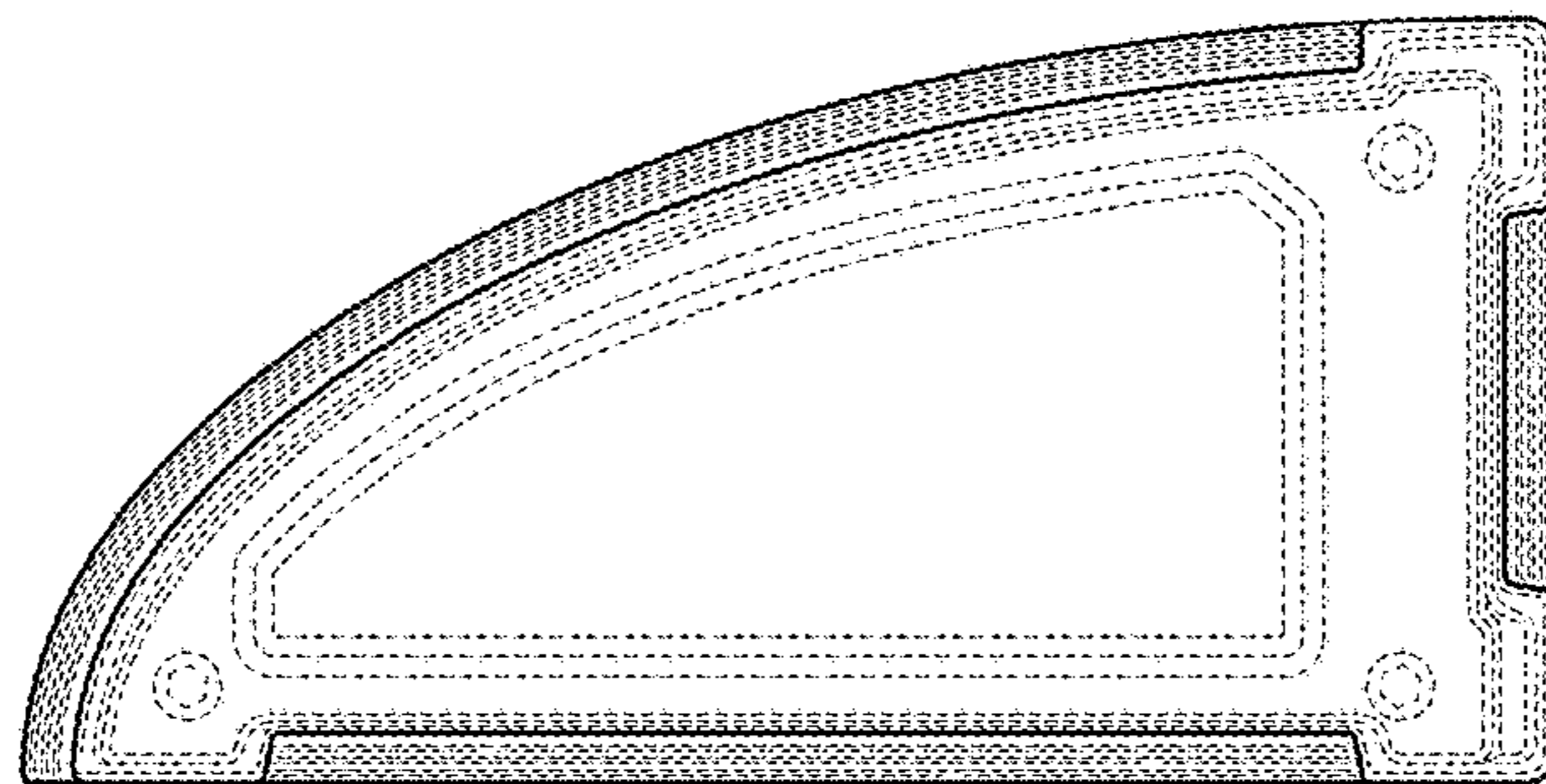

FIG. 7



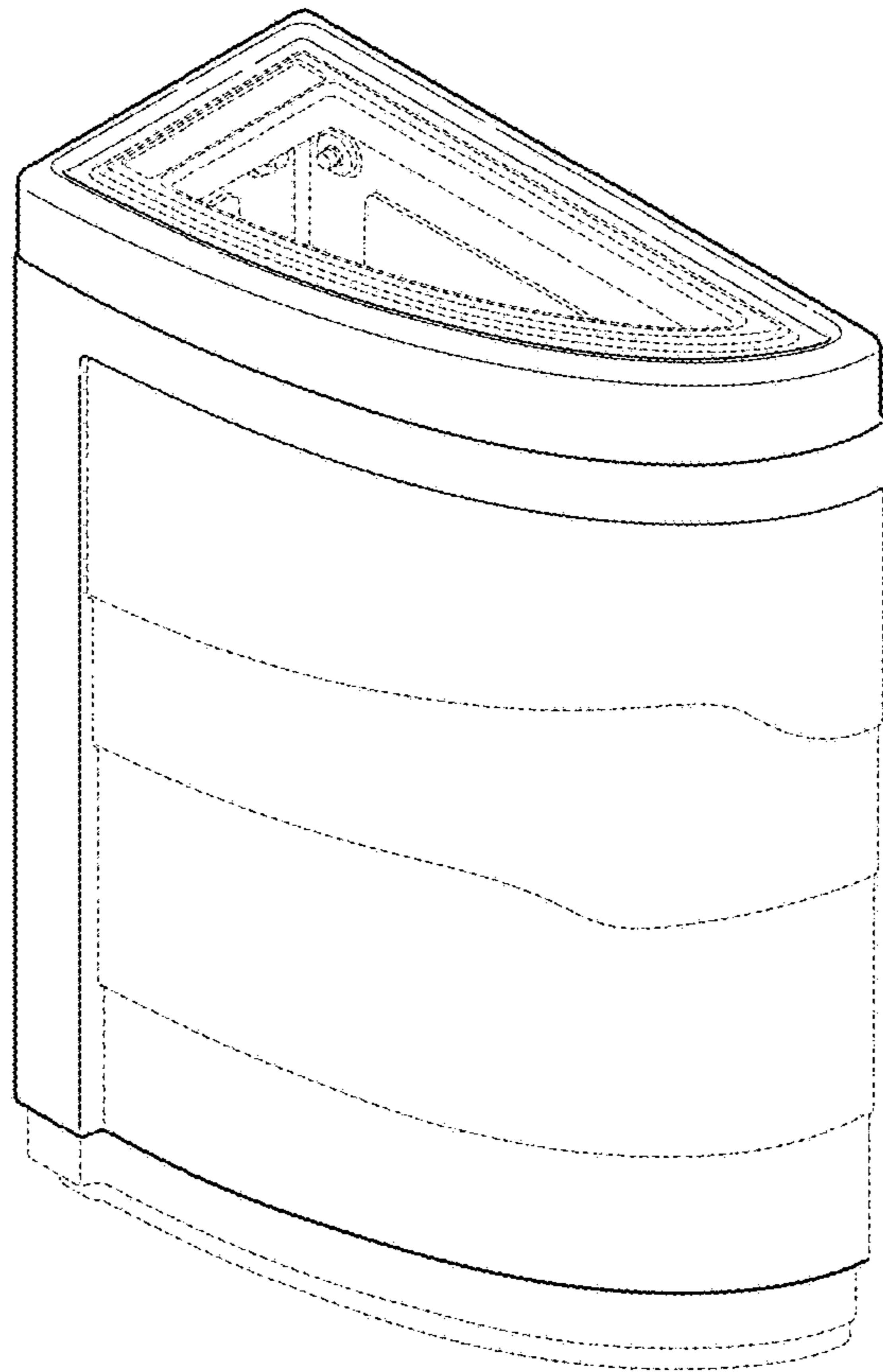

FIG. 8



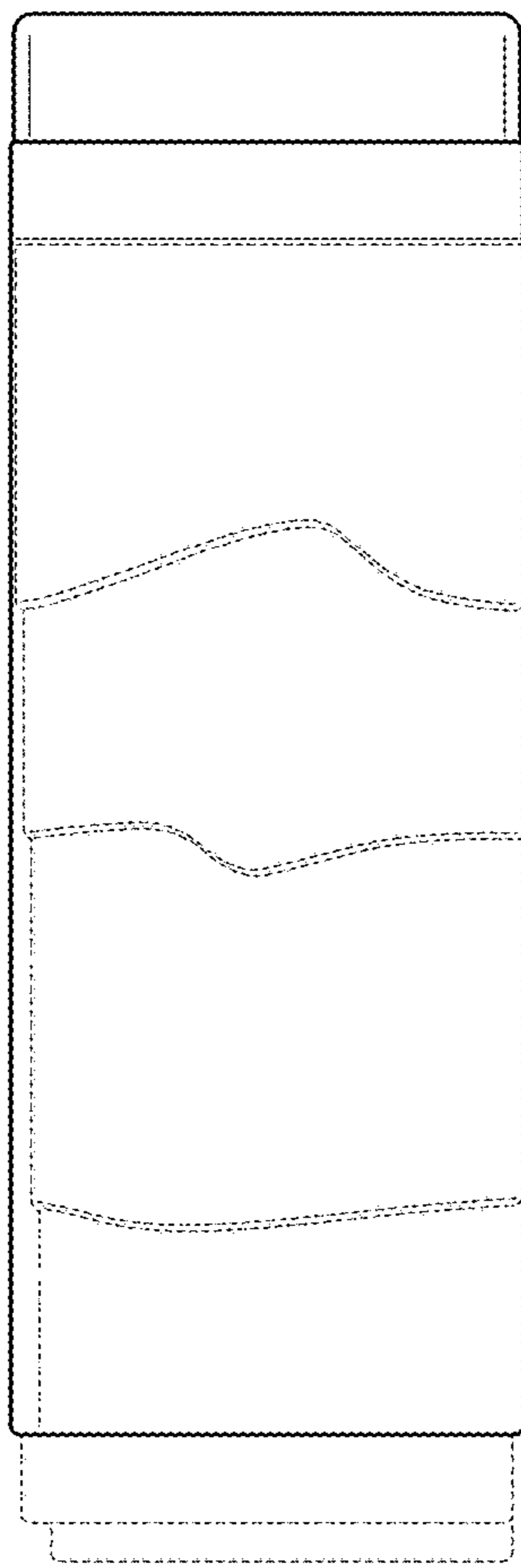

FIG. 9

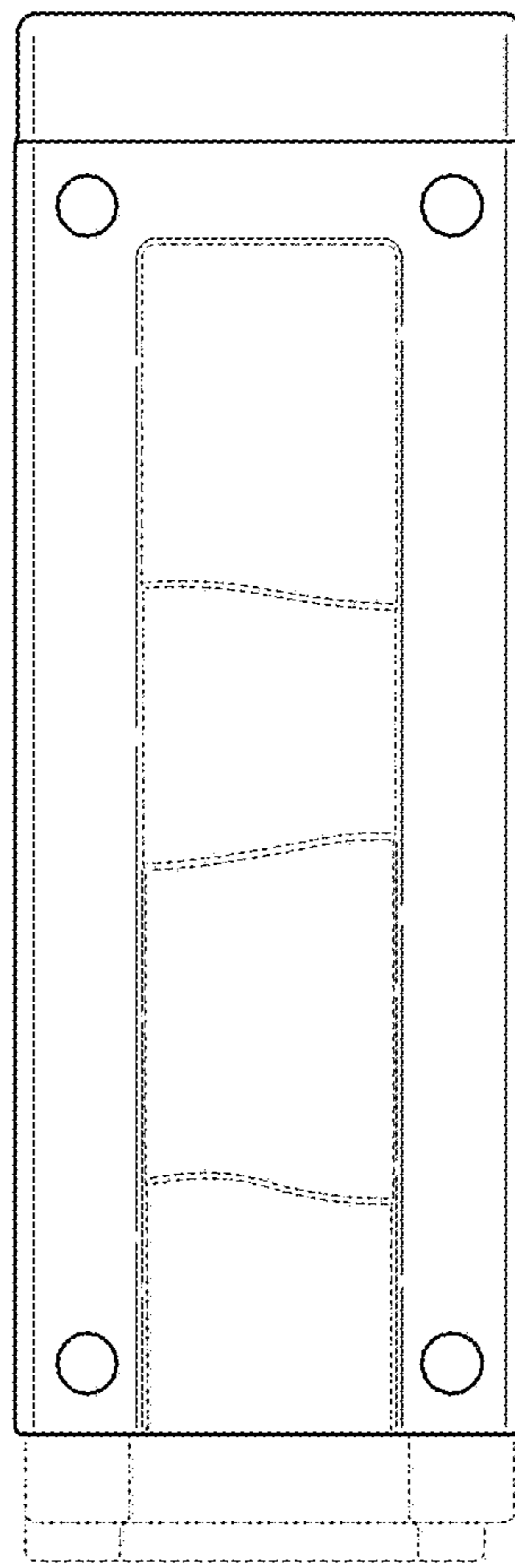

FIG. 10

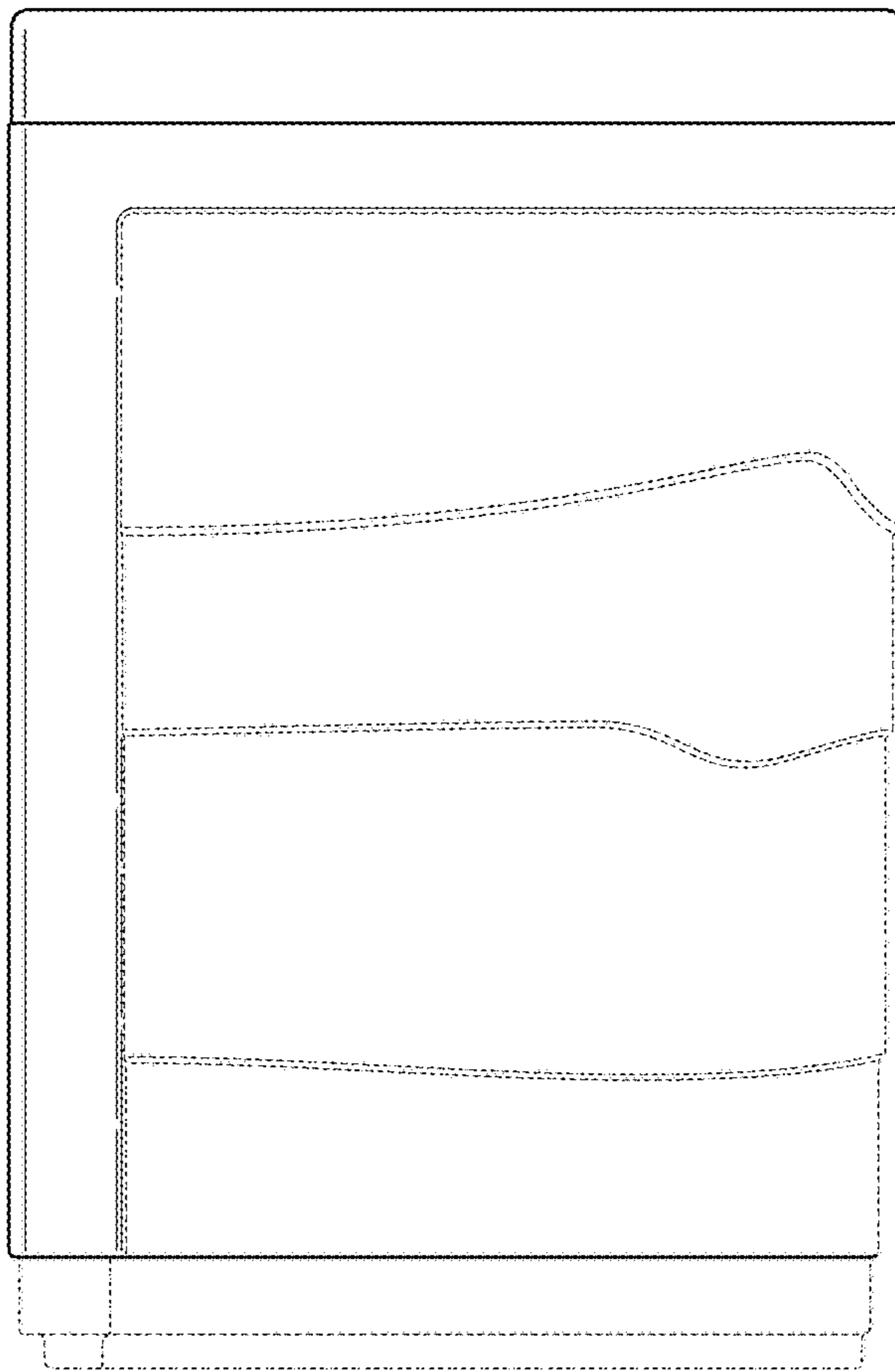

FIG. 11

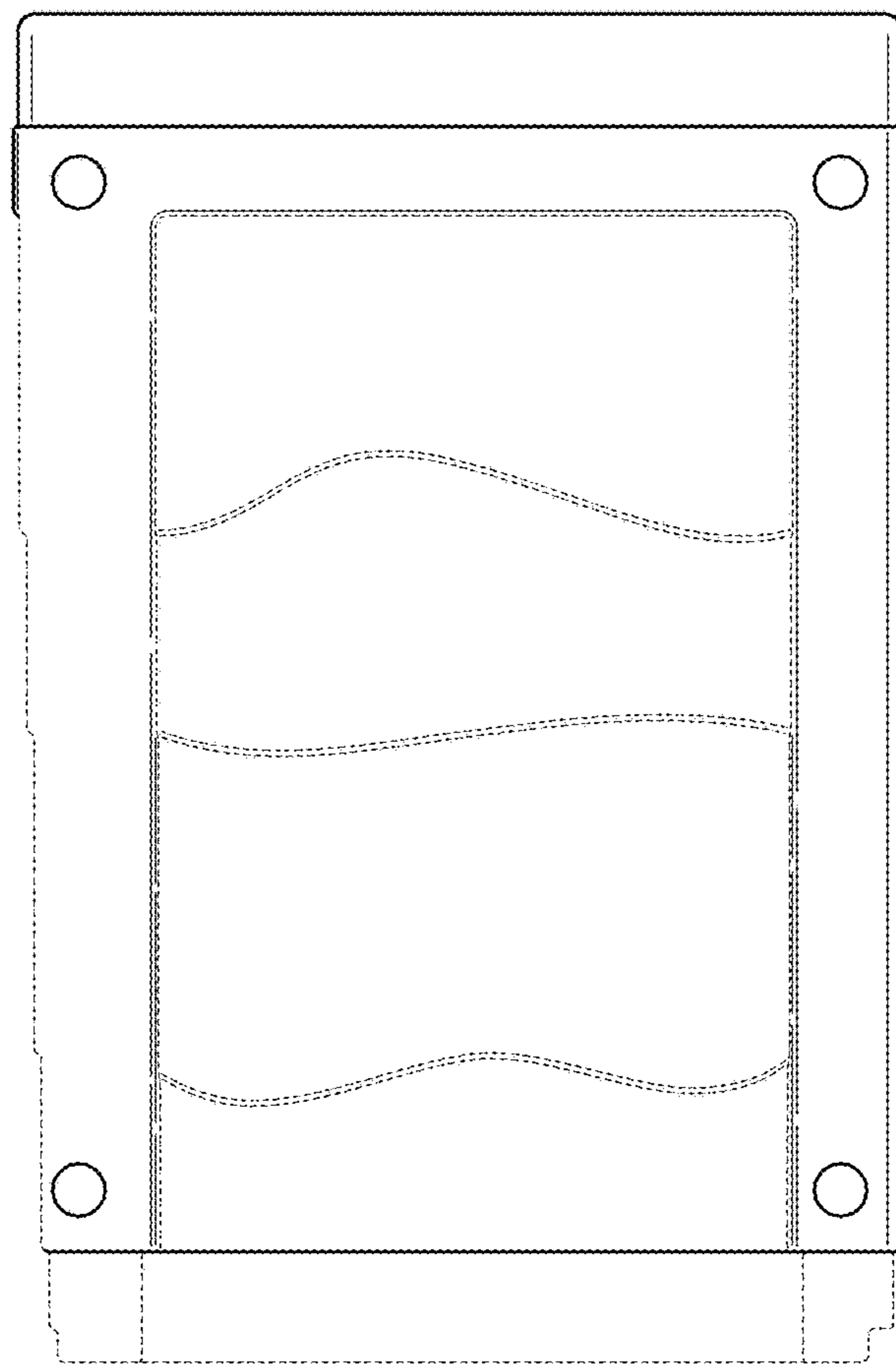

FIG. 12

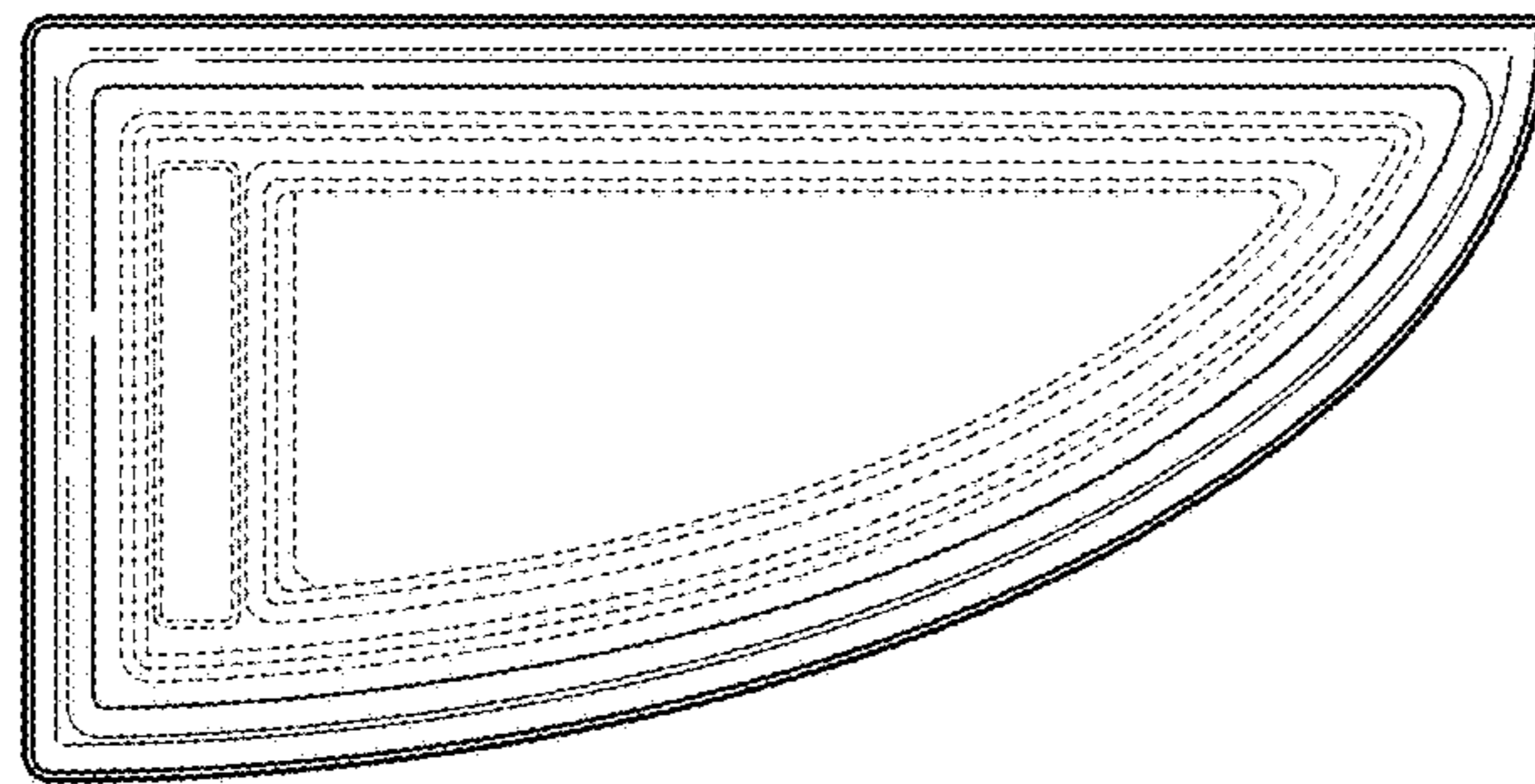

FIG. 13

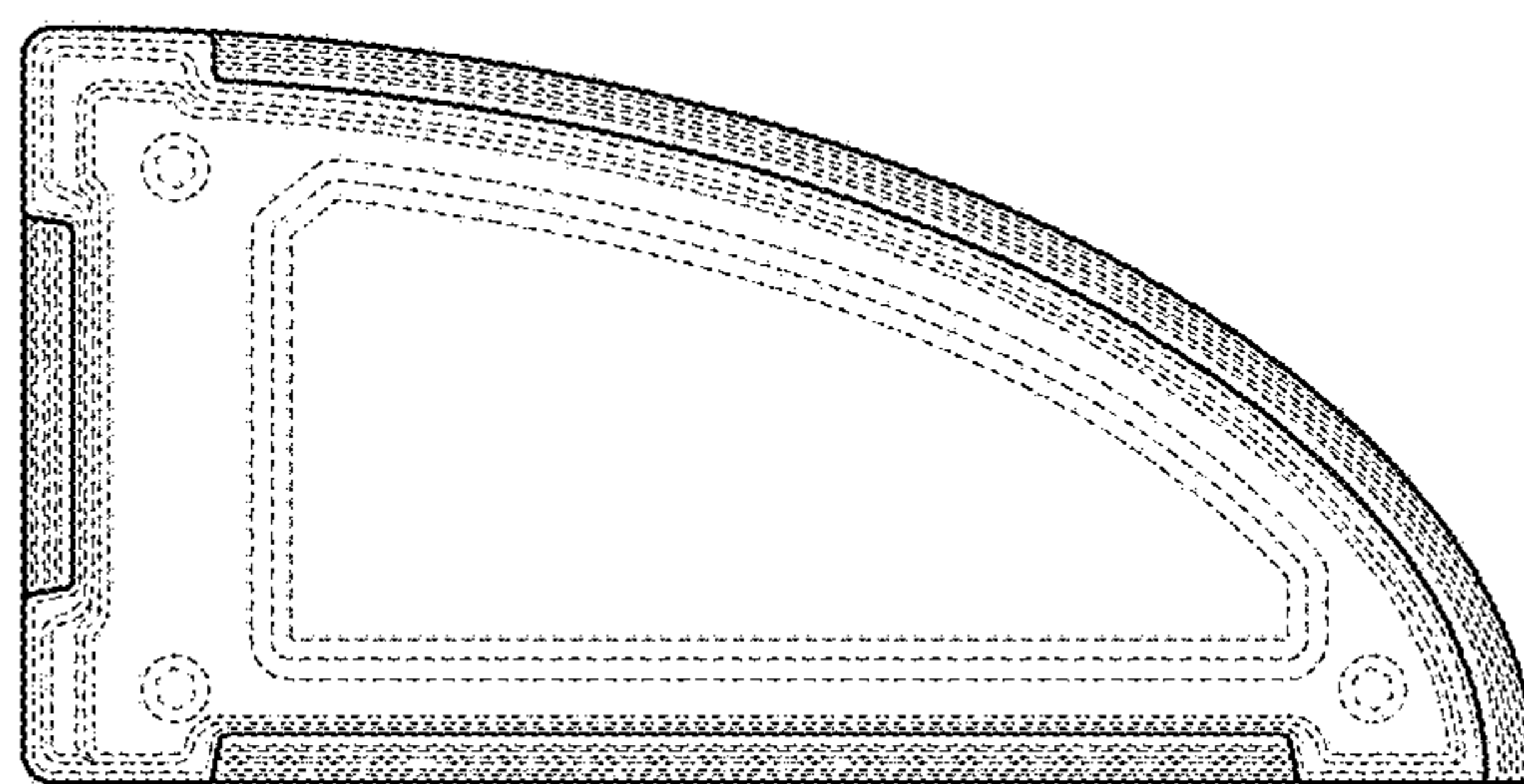

FIG. 14