



US00D848683S

(12) **United States Design Patent**
Pinto et al.

(10) **Patent No.:** **US D848,683 S**

(45) **Date of Patent:** **** May 14, 2019**

(54) **PET TOY**

(71) Applicant: **Doskocil Manufacturing Company, Inc.**, Arlington, TX (US)

(72) Inventors: **Sunil Pinto**, Arlington, TX (US); **Jack Renforth**, Azle, TX (US)

(73) Assignee: **DOSKOCIL MANUFACTURING COMPANY, INC.**, Arlington, TX (US)

(**) Term: **15 Years**

(21) Appl. No.: **29/611,463**

(22) Filed: **Jul. 21, 2017**

(51) **LOC (11) Cl.** **30-99**

(52) **U.S. Cl.**

USPC **D30/160**

(58) **Field of Classification Search**

USPC D21/398, 400, 402, 412, 415, 426, 436, D21/439, 440, 441, 443, 455, 460-462, D21/466-468, 479, 495, 563, 656, 712, D21/713, 788, 799.1, 470, 681, 386, 484, D21/707, 408, 437, 673, 678, 679, 682; D24/211, 214, 215, 193-195, 212; D30/160, 112, 119; D1/125-127, 120
CPC A63H 5/00; A63H 33/26; A63H 33/18; A63H 29/22; A63H 29/24; A63H 2200/00; A63H 11/00; A63H 13/00; A63H 18/02; A63H 18/14; A63H 18/16; A63H 29/00; A63H 33/009; A63H 33/22; A63H 33/3055; A63H 3/003; A63H 3/006; A63H 3/008; A63H 3/24; A63H 3/28; A63H 3/31; A63H 3/36; A63H 9/00; A63B 59/20; A63B 69/406; A63B 47/04; A63B 2220/51; A63B 2220/53; A63B 2220/56; A63B 2220/805; A63B 2071/0625; A63B 2071/063; A63B 2220/17; A63B 2220/18; A63B 2220/40;

(Continued)

(56) **References Cited**

U.S. PATENT DOCUMENTS

1,531,162 A * 3/1925 Valero A63B 37/12
473/600
5,048,829 A * 9/1991 Prokupek A63B 43/002
473/595

(Continued)

Primary Examiner — Lilyana Bekic

Assistant Examiner — Aula Soroush

(74) *Attorney, Agent, or Firm* — Global IP Counselors, LLP

(57) **CLAIM**

The ornamental design for a pet toy, as shown and described.

DESCRIPTION

FIG. 1 is a top perspective view of a first embodiment of a pet toy in accordance with our new design; FIG. 2 is a bottom perspective view thereof; FIG. 3 is a side perspective view thereof; FIG. 4 is a top view thereof; FIG. 5 is a bottom view thereof; FIG. 6 is a front view thereof; FIG. 7 is a back view thereof; FIG. 8 is a right side view thereof; FIG. 9 is a left side view thereof; FIG. 10 is a top perspective view of a second embodiment of a pet toy in accordance with our new design; FIG. 11 is a bottom perspective view thereof; FIG. 12 is a side perspective view thereof; FIG. 13 is a top view thereof; FIG. 14 is a bottom view thereof; FIG. 15 is a front view thereof; FIG. 16 is a back view thereof; FIG. 17 is a right side view thereof; and, FIG. 18 is a left side view thereof. The broken lines in the drawings illustrate portions of the pet toy that form no part of the claimed design.

1 Claim, 18 Drawing Sheets

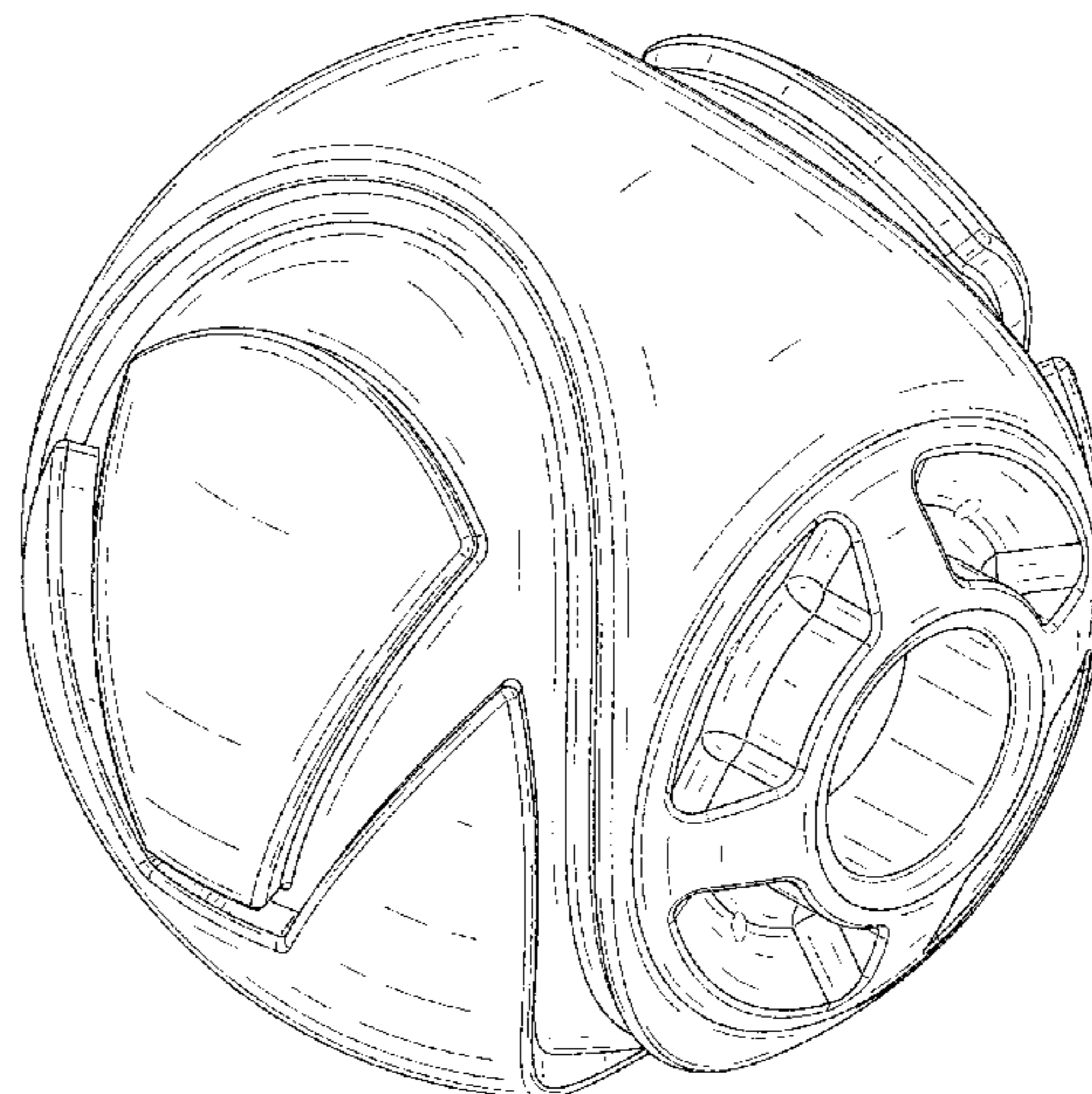
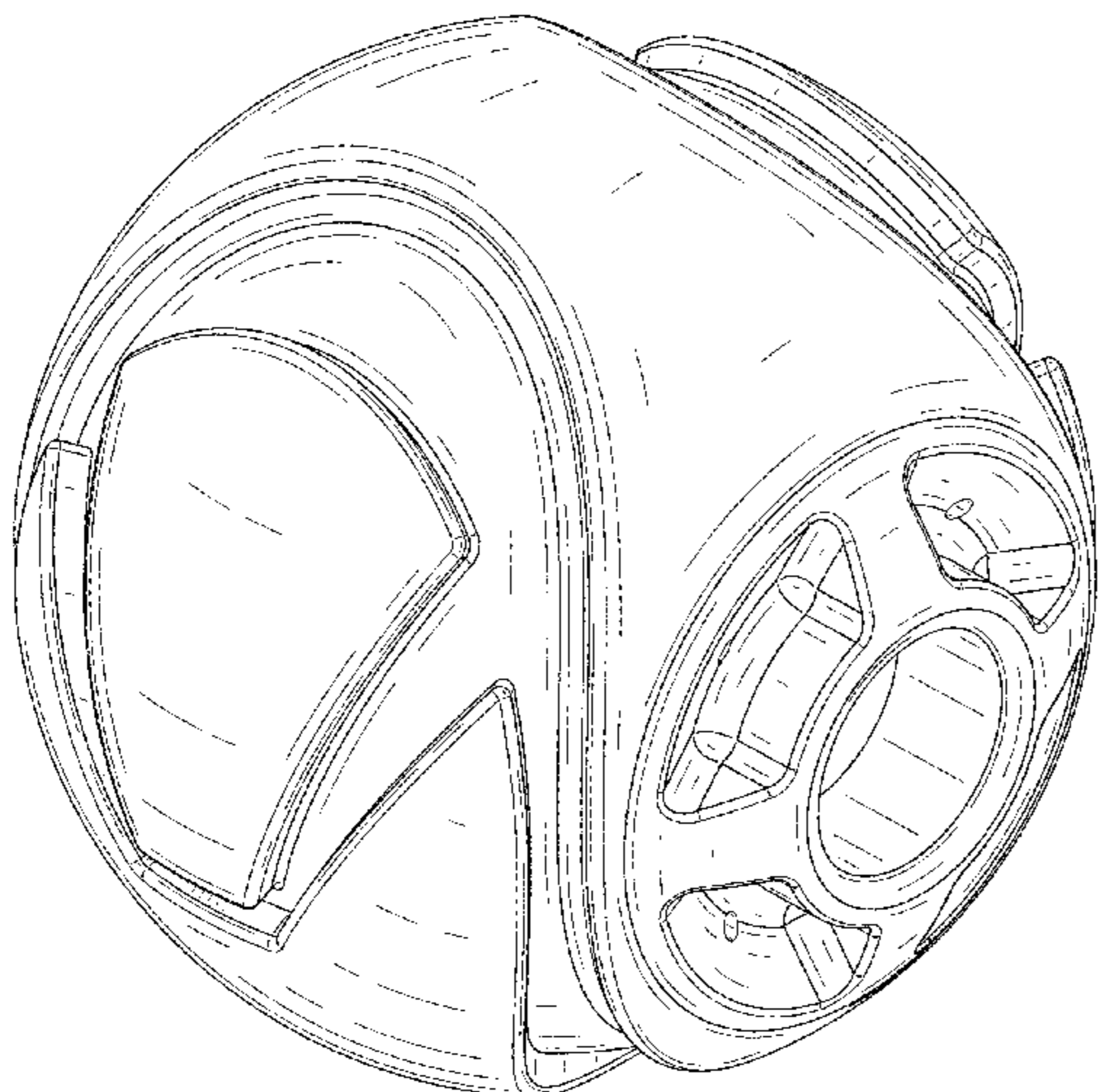

(58) **Field of Classification Search**

CPC A63B 2220/803; A63B 2220/833; A63B
43/004; A63B 43/06; A63B 71/0622;
A63B 2071/0602; A63B 21/0055; A63B
2207/02; A63B 2225/54; A63B 69/0053;
A63B 2047/043

See application file for complete search history.

(56) **References Cited**

U.S. PATENT DOCUMENTS

5,588,648 A * 12/1996 Stebbins A63B 37/02
473/451
D424,256 S * 5/2000 Lindgren D21/714
6,224,513 B1 * 5/2001 Chow A63B 23/16
473/601
D456,959 S * 5/2002 Simon D30/160
D516,145 S * 2/2006 Oblack D21/713
D577,396 S * 9/2008 Burger D21/713
D609,290 S * 2/2010 Oblack D21/713
D617,509 S * 6/2010 Rutherford D30/160
D673,740 S * 1/2013 Burger D21/707
D707,303 S * 6/2014 Saber D21/398
D722,730 S * 2/2015 Simon D30/160
D736,483 S * 8/2015 Crane D30/160
D746,002 S * 12/2015 Crane D30/160
D776,371 S * 1/2017 Tome D30/160
D817,562 S * 5/2018 Markham D30/160
D822,918 S * 7/2018 Woods D30/160
D822,919 S * 7/2018 Woods D30/160

* cited by examiner

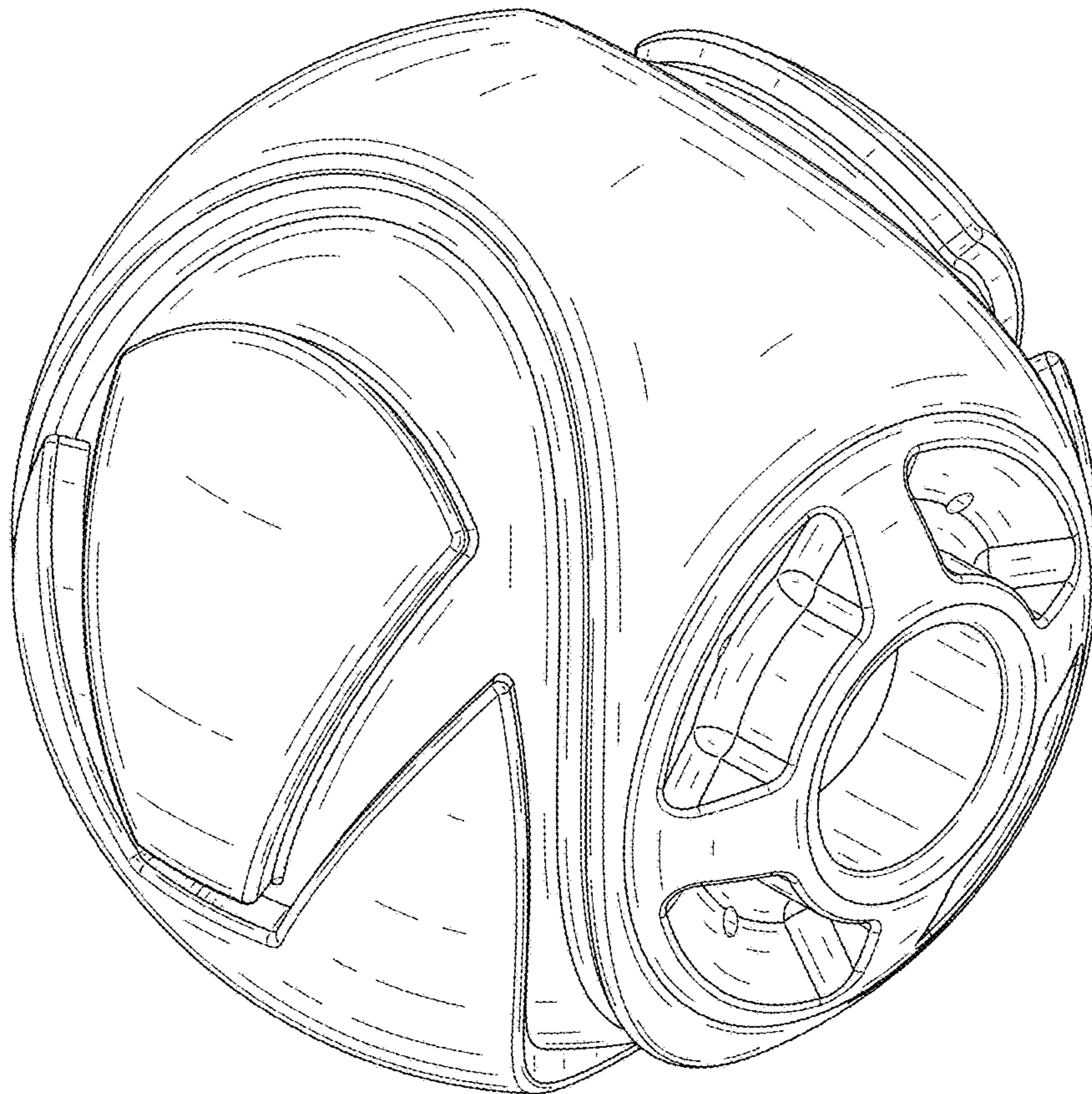

FIG. 1

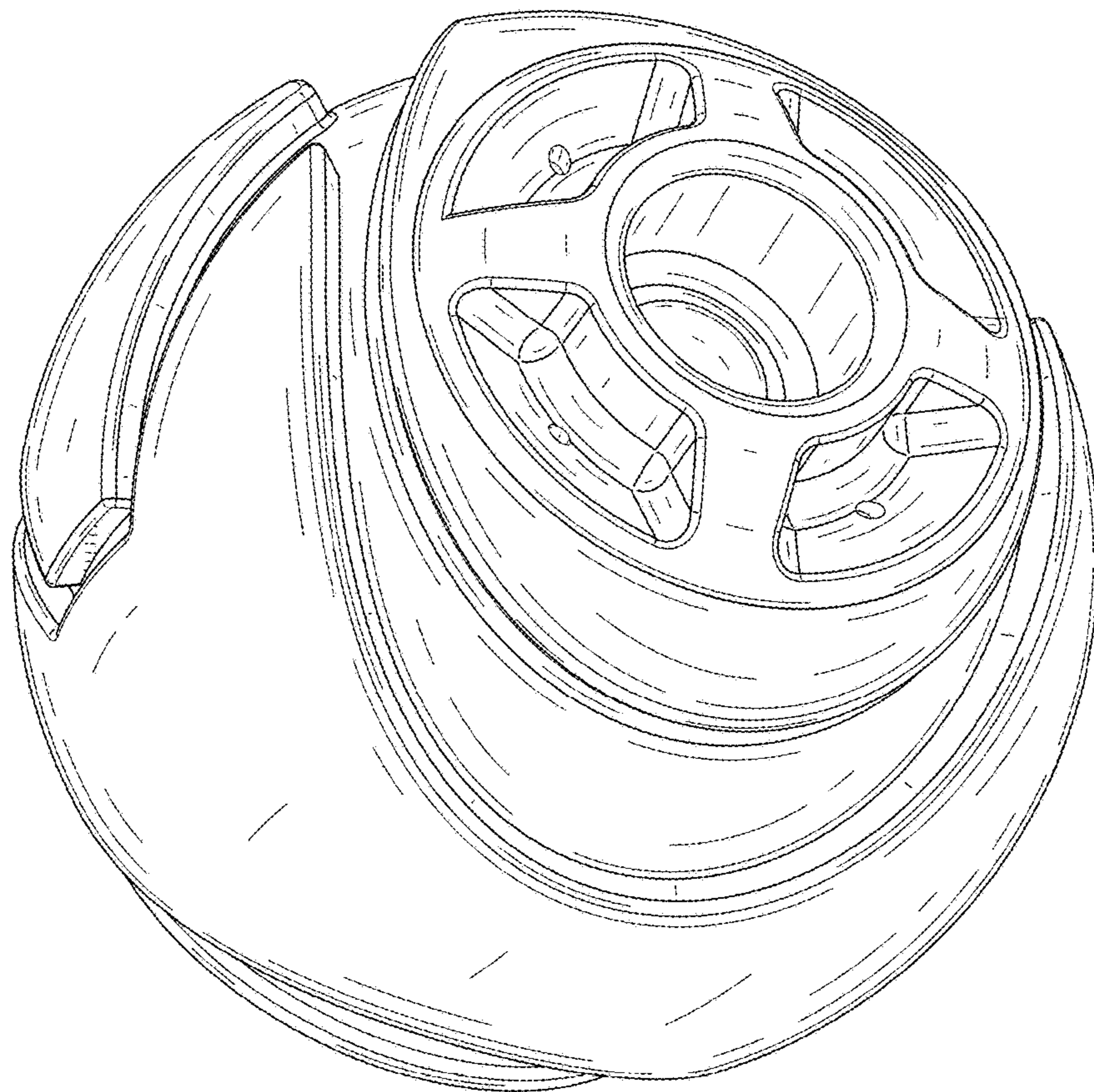

FIG. 2



FIG. 3

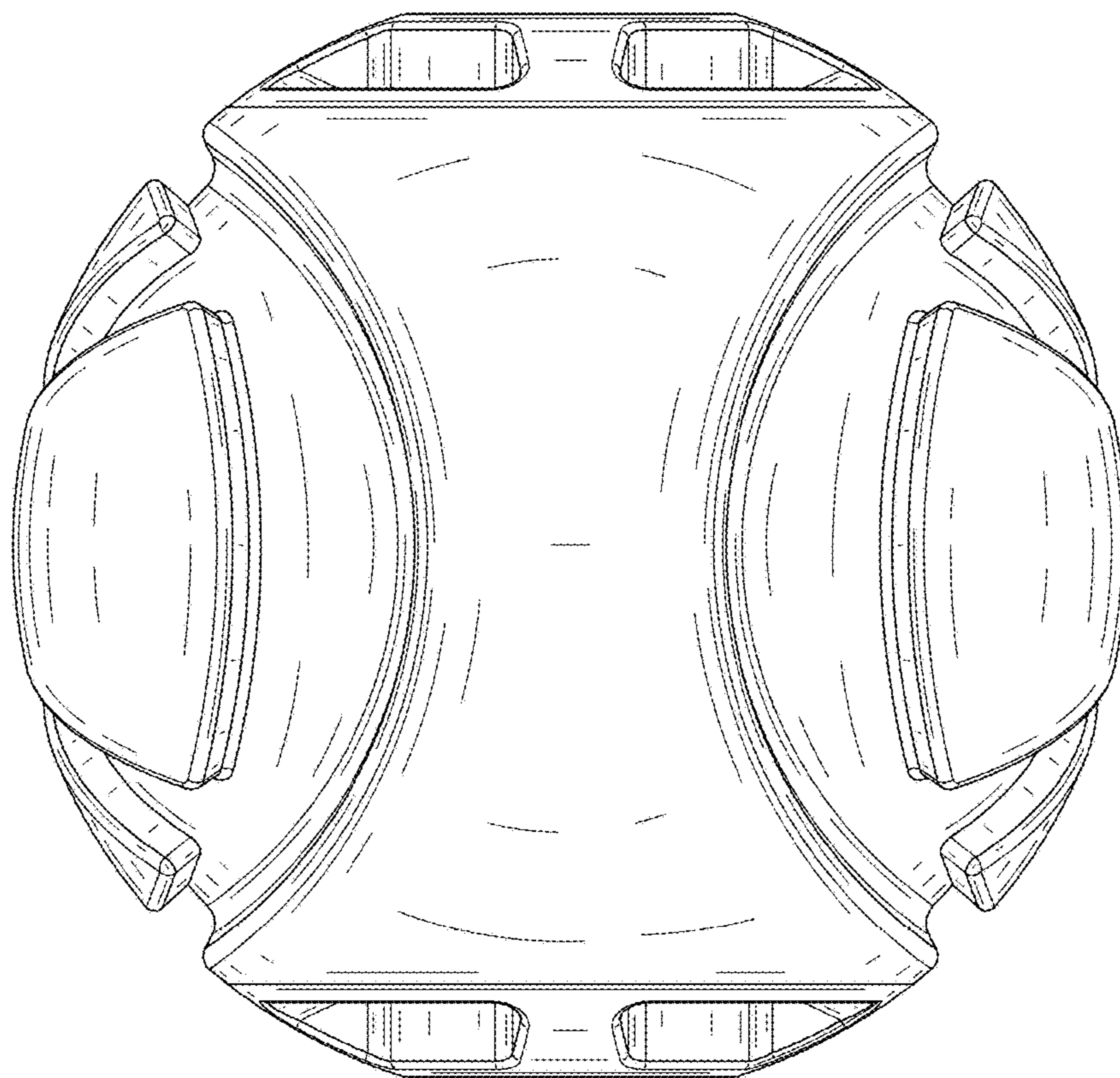

FIG. 4

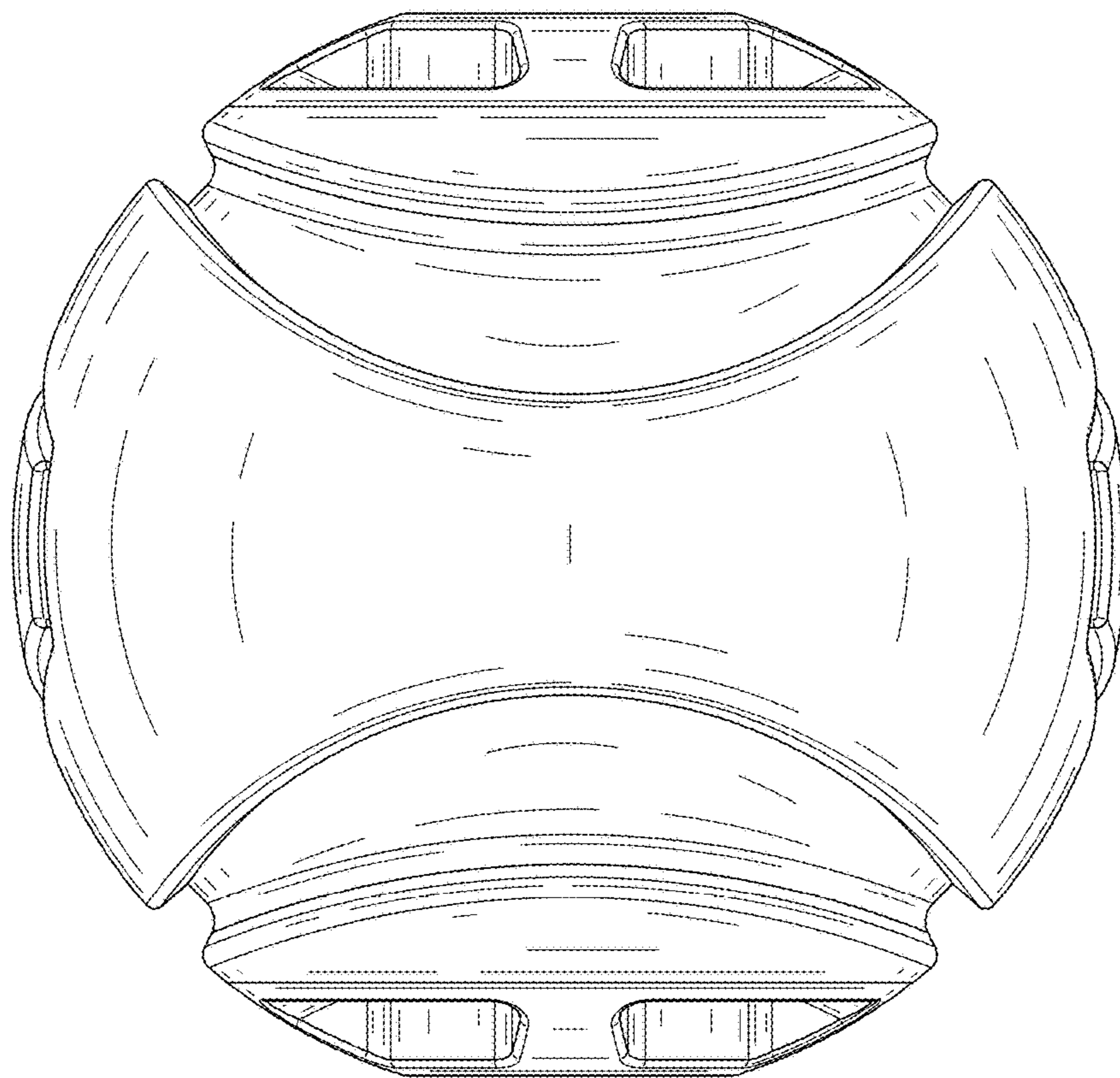

FIG. 5

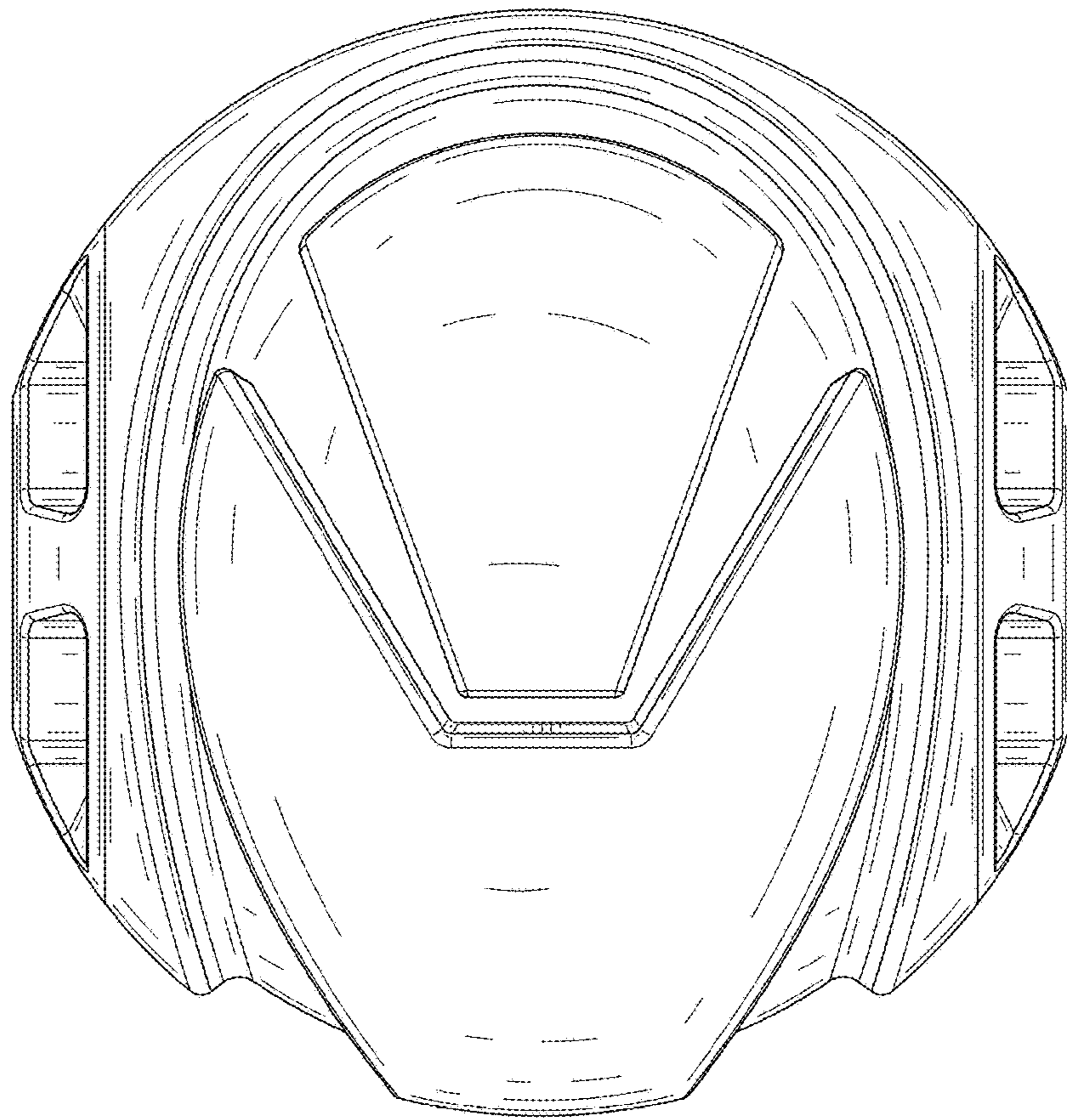

FIG. 6

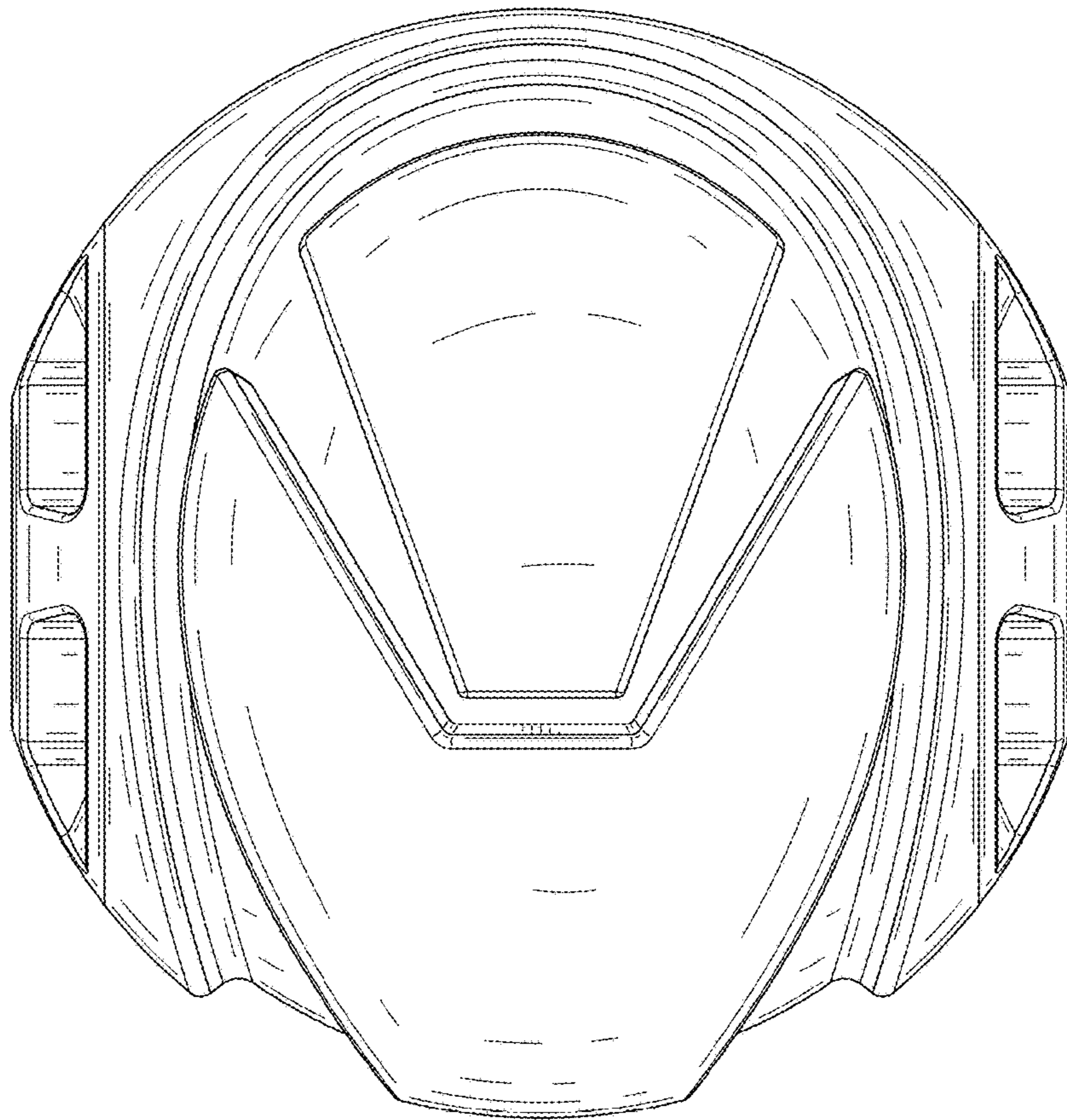

FIG. 7

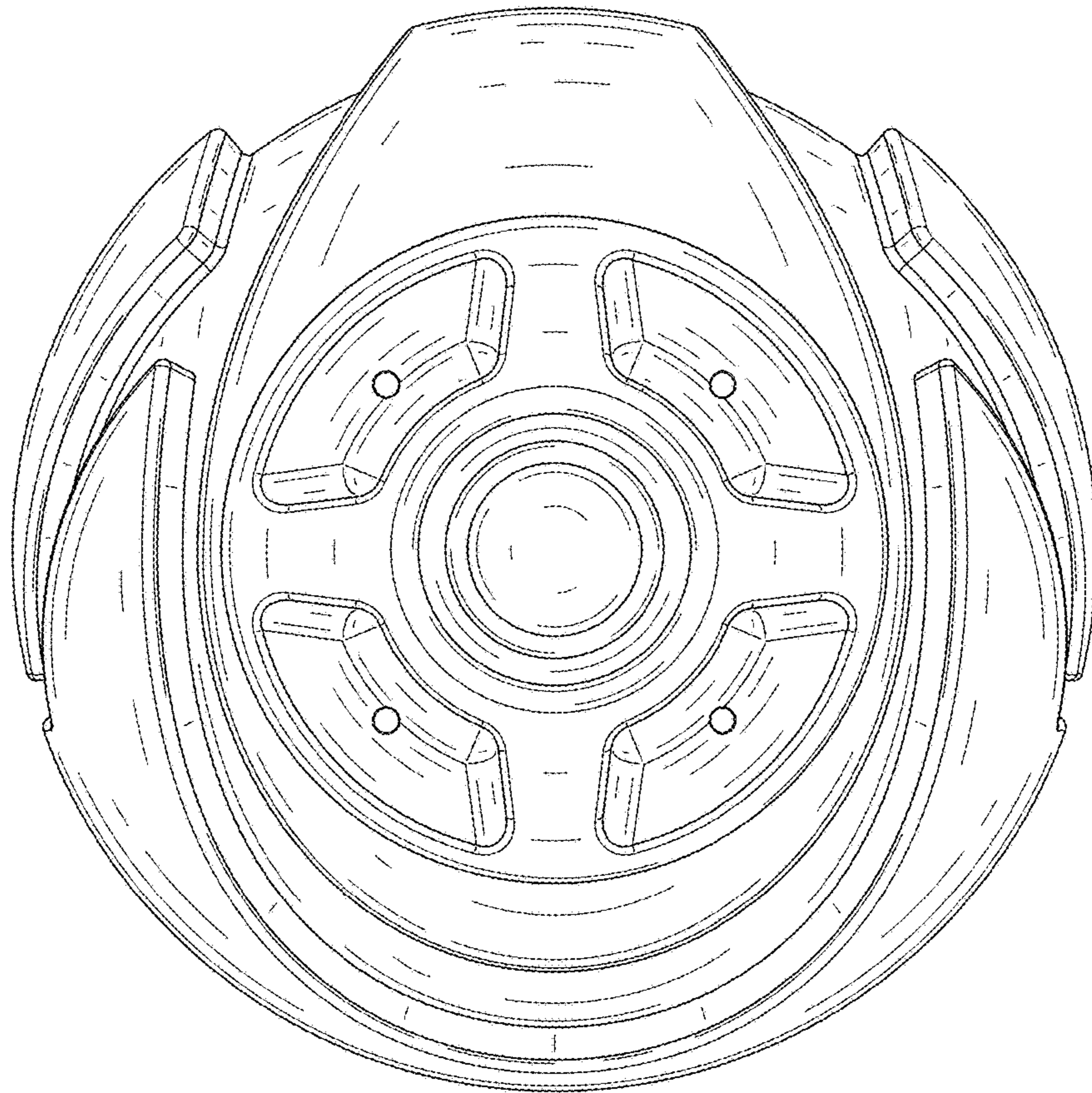

FIG. 8

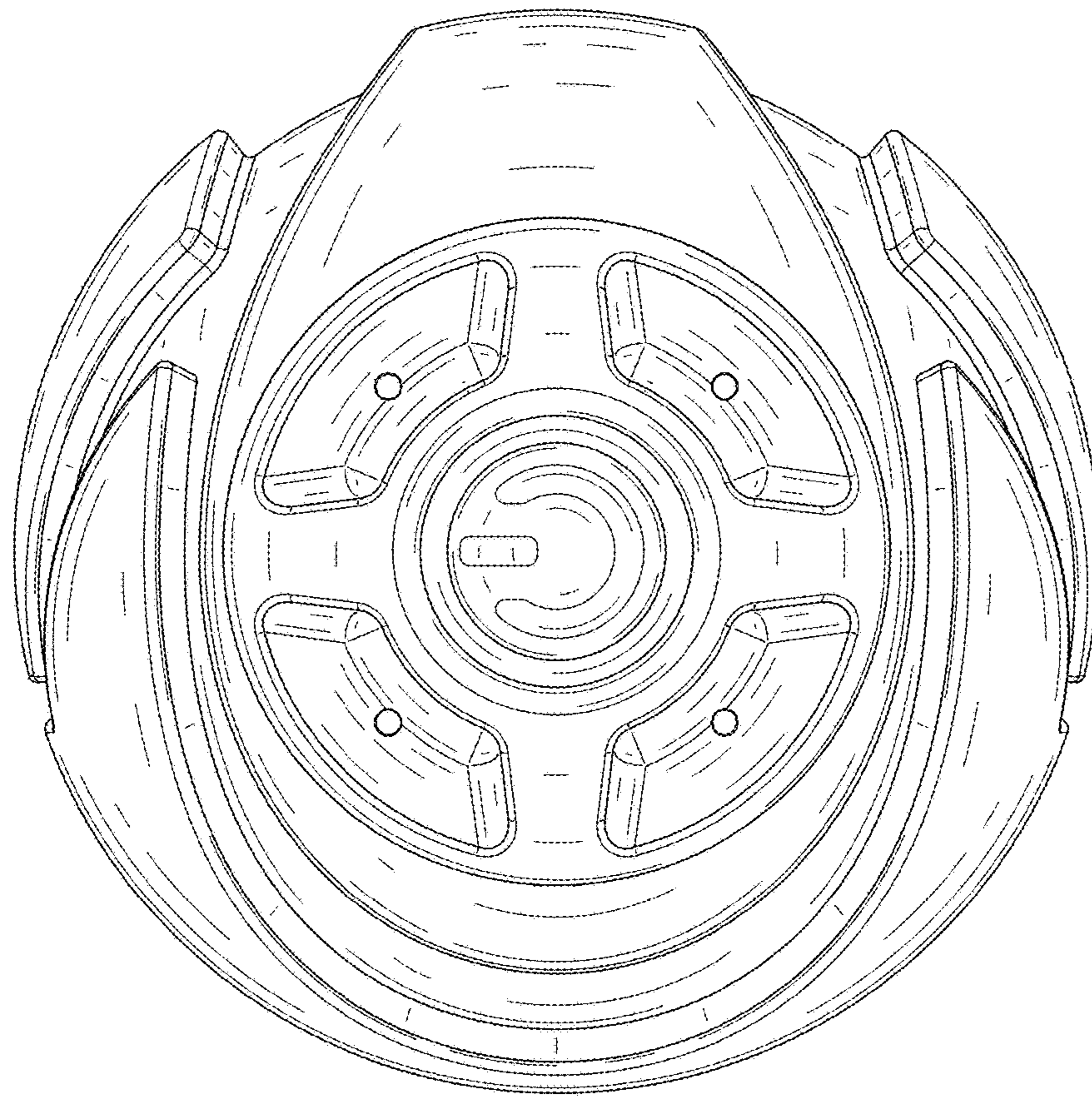

FIG. 9

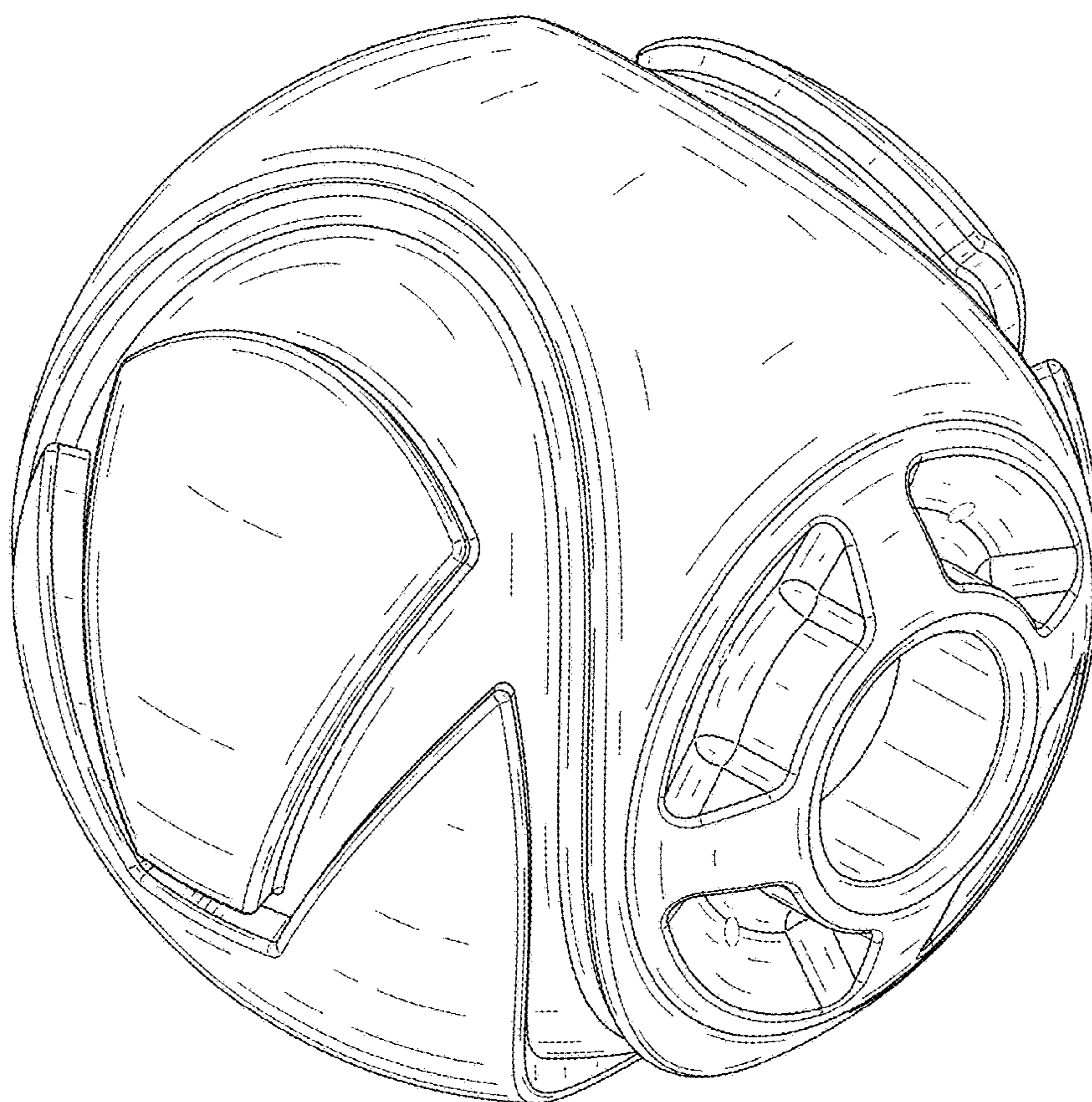

FIG. 10

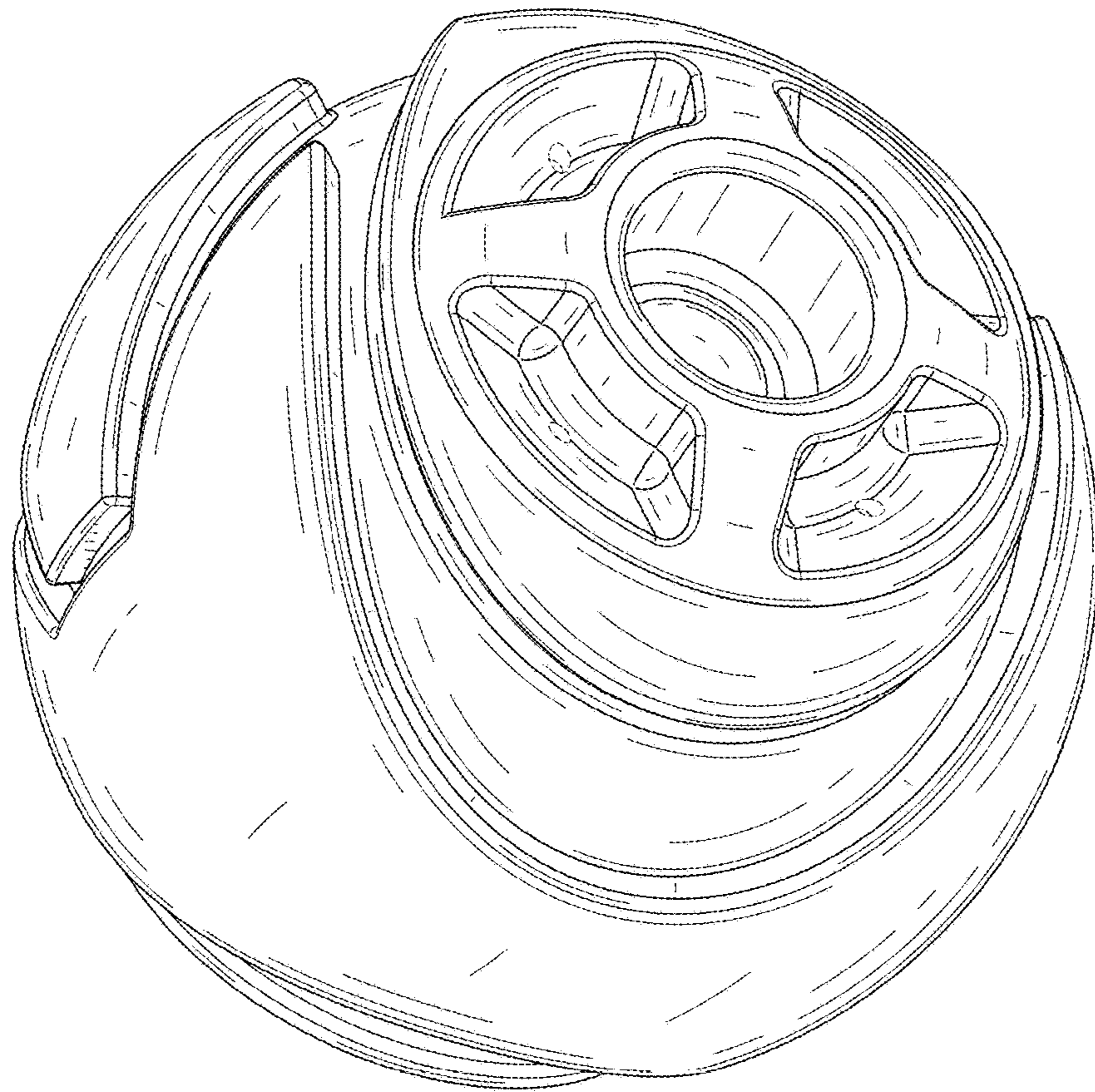

FIG. 11



FIG. 12

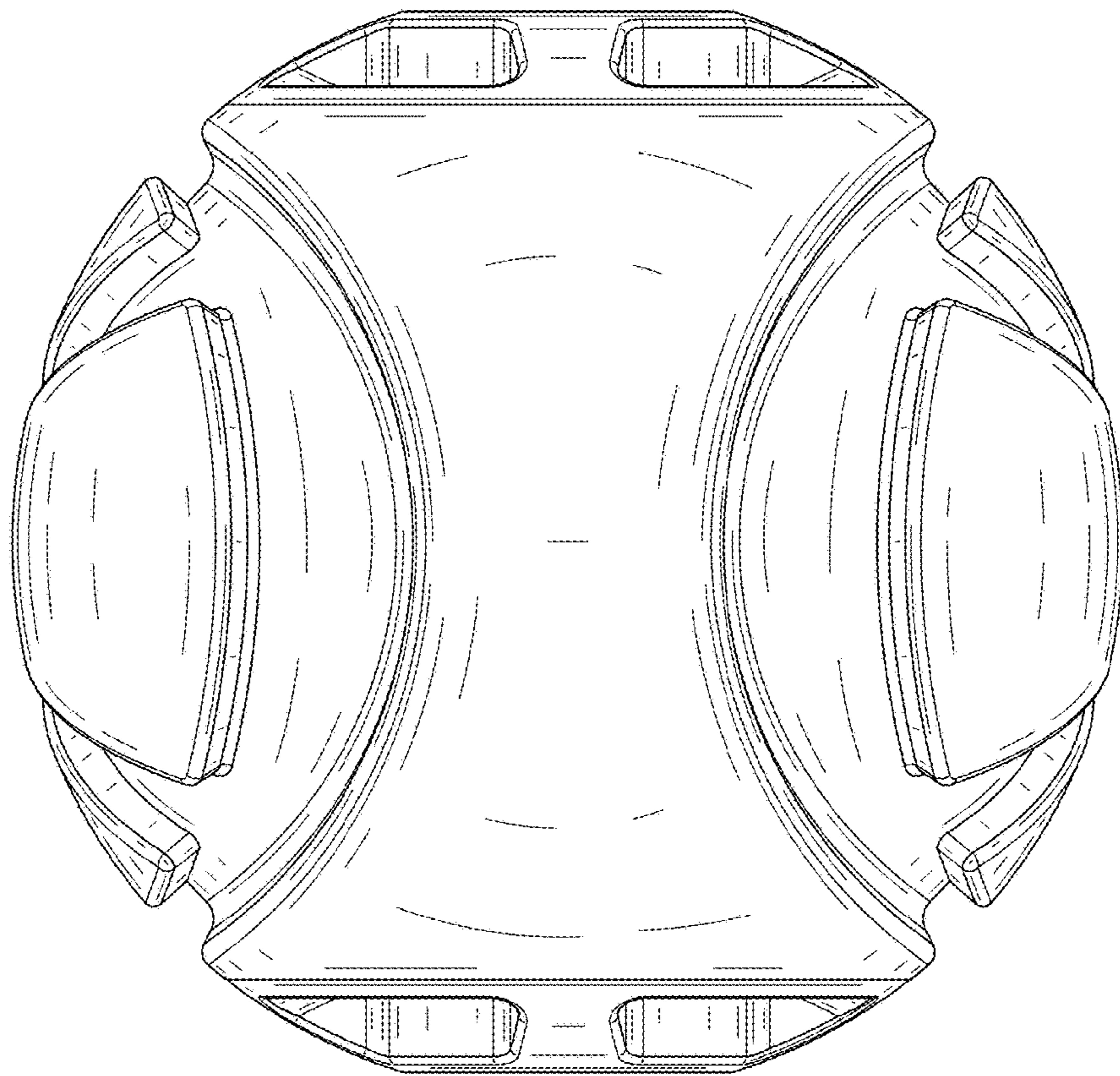

FIG. 13

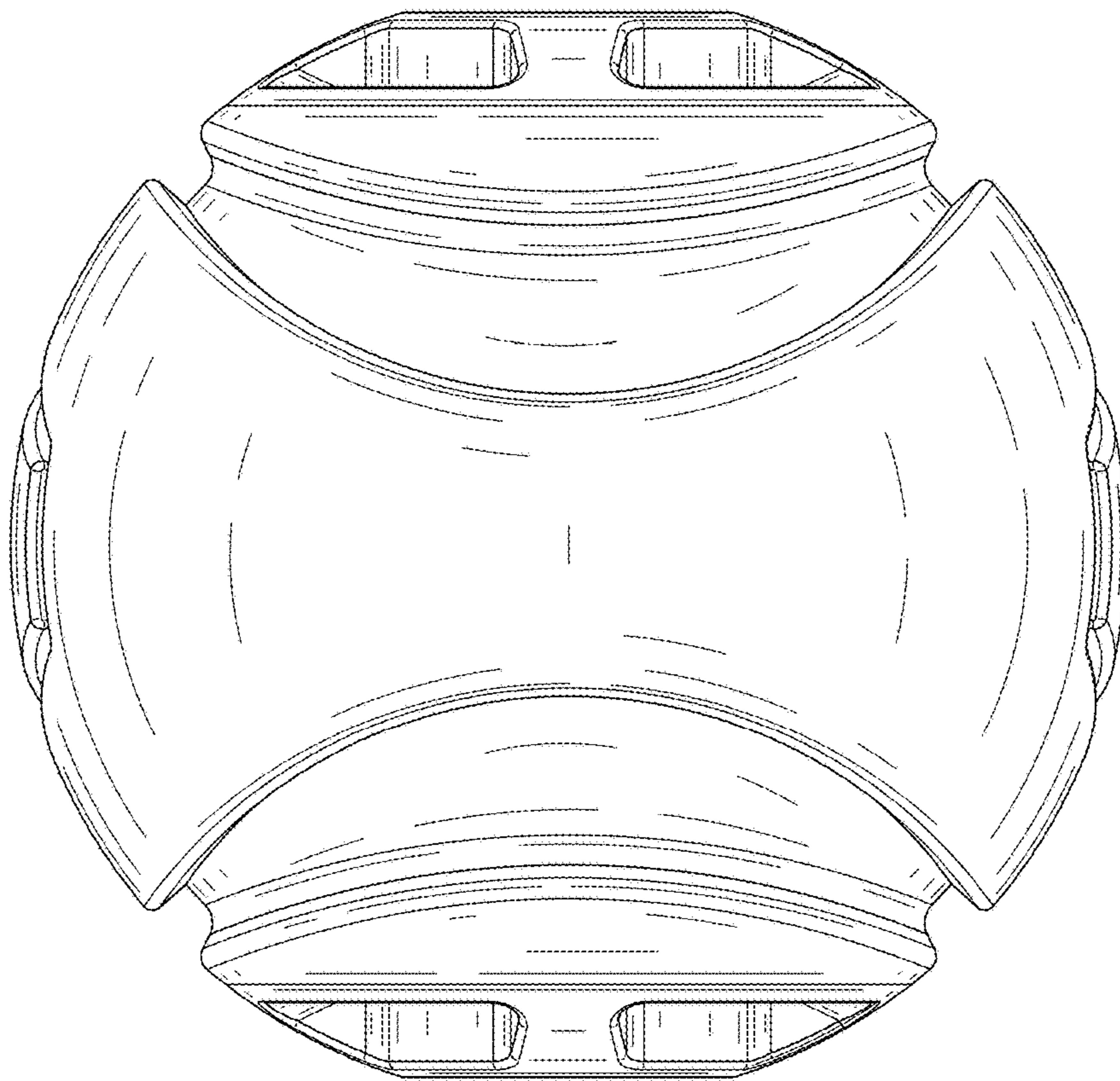

FIG. 14

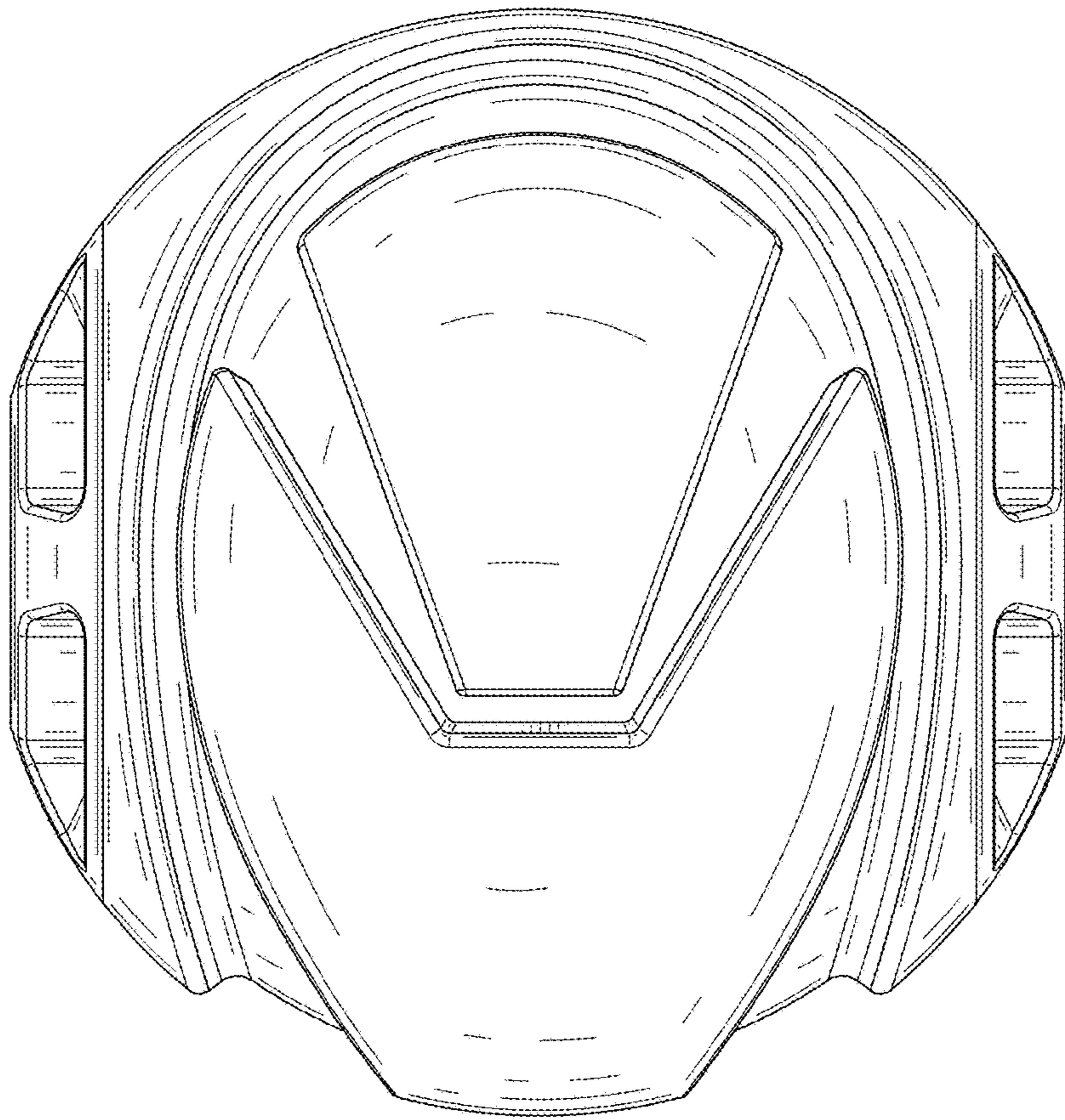

FIG. 15

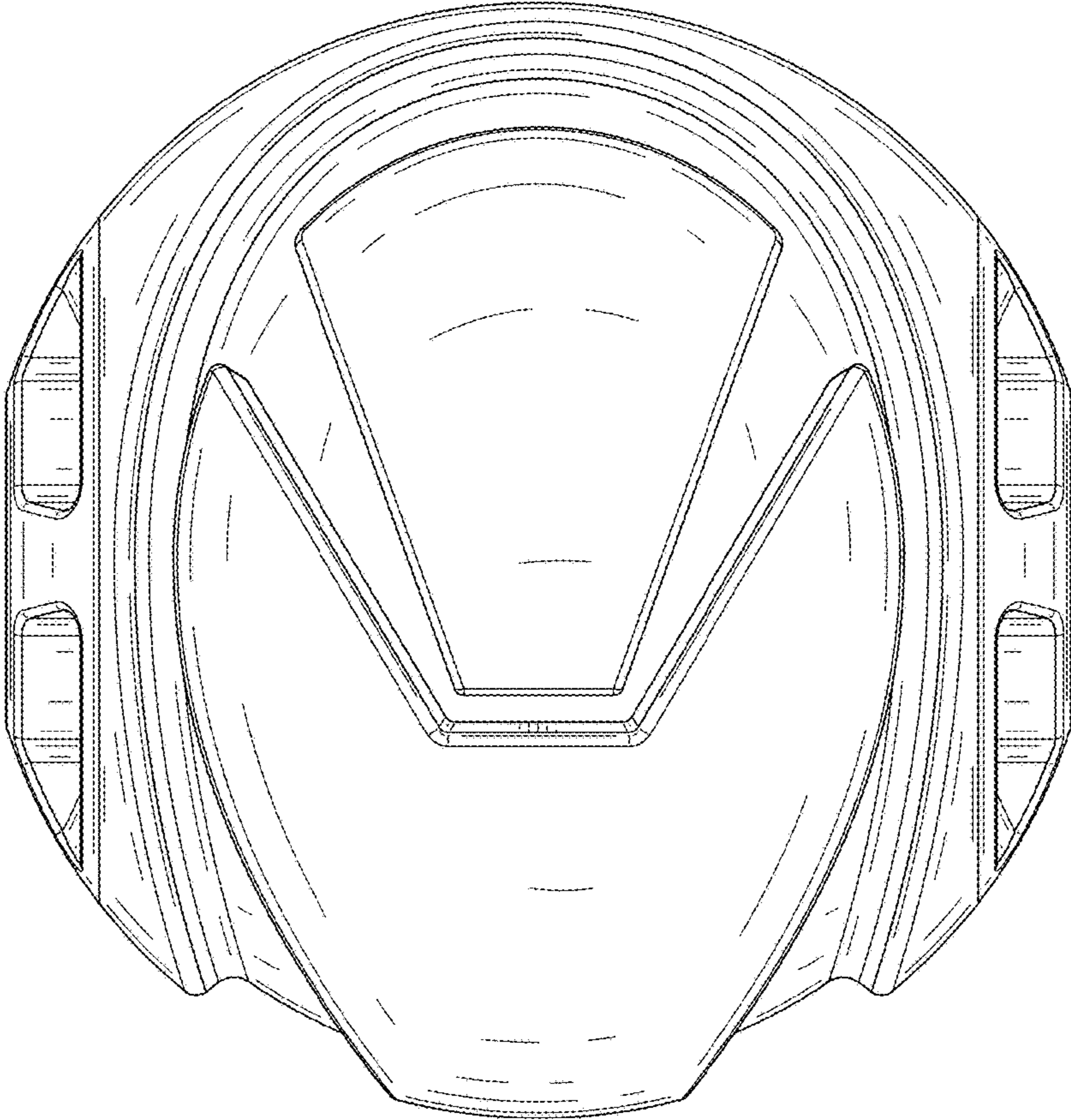

FIG. 16

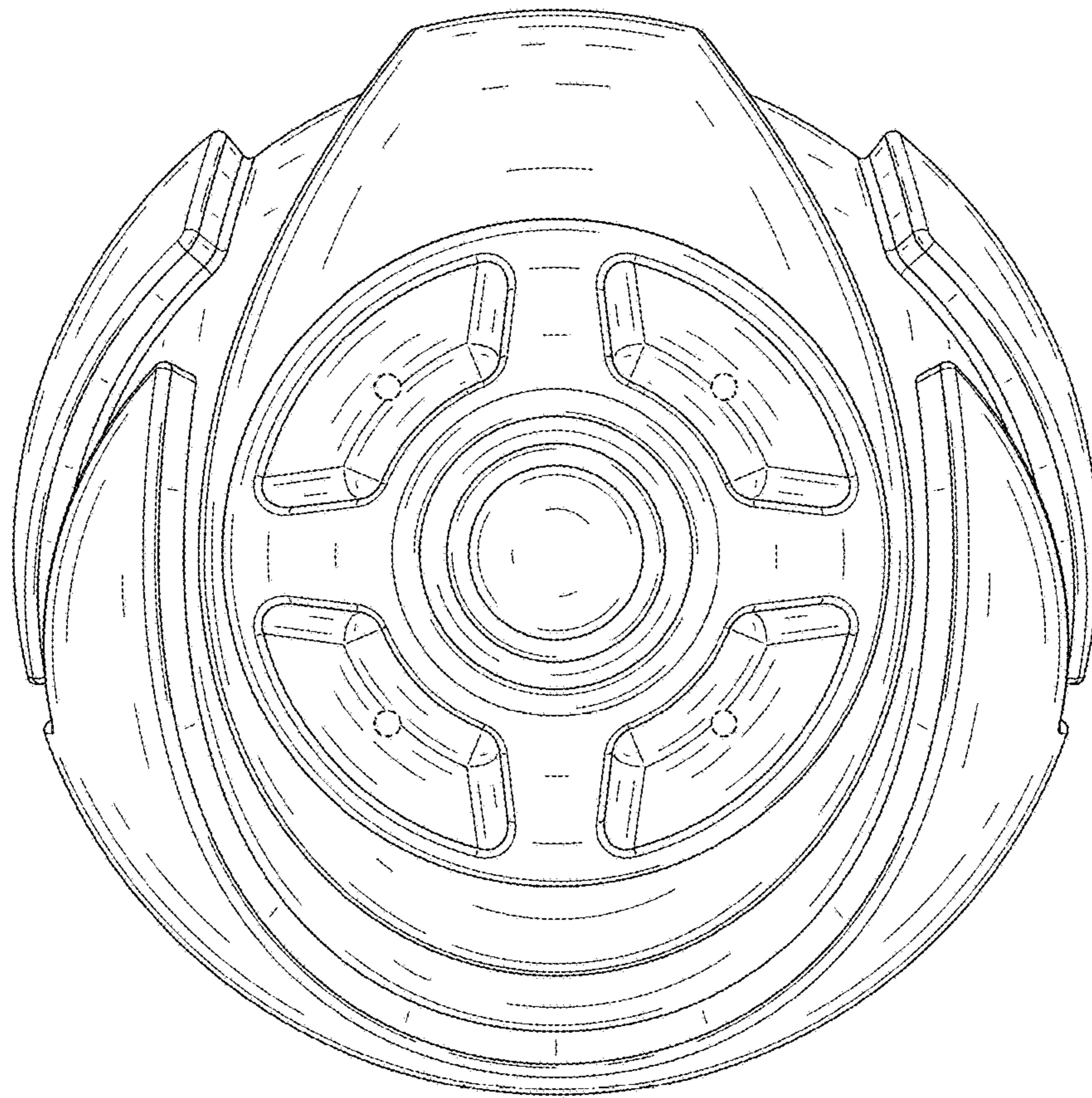

FIG. 17

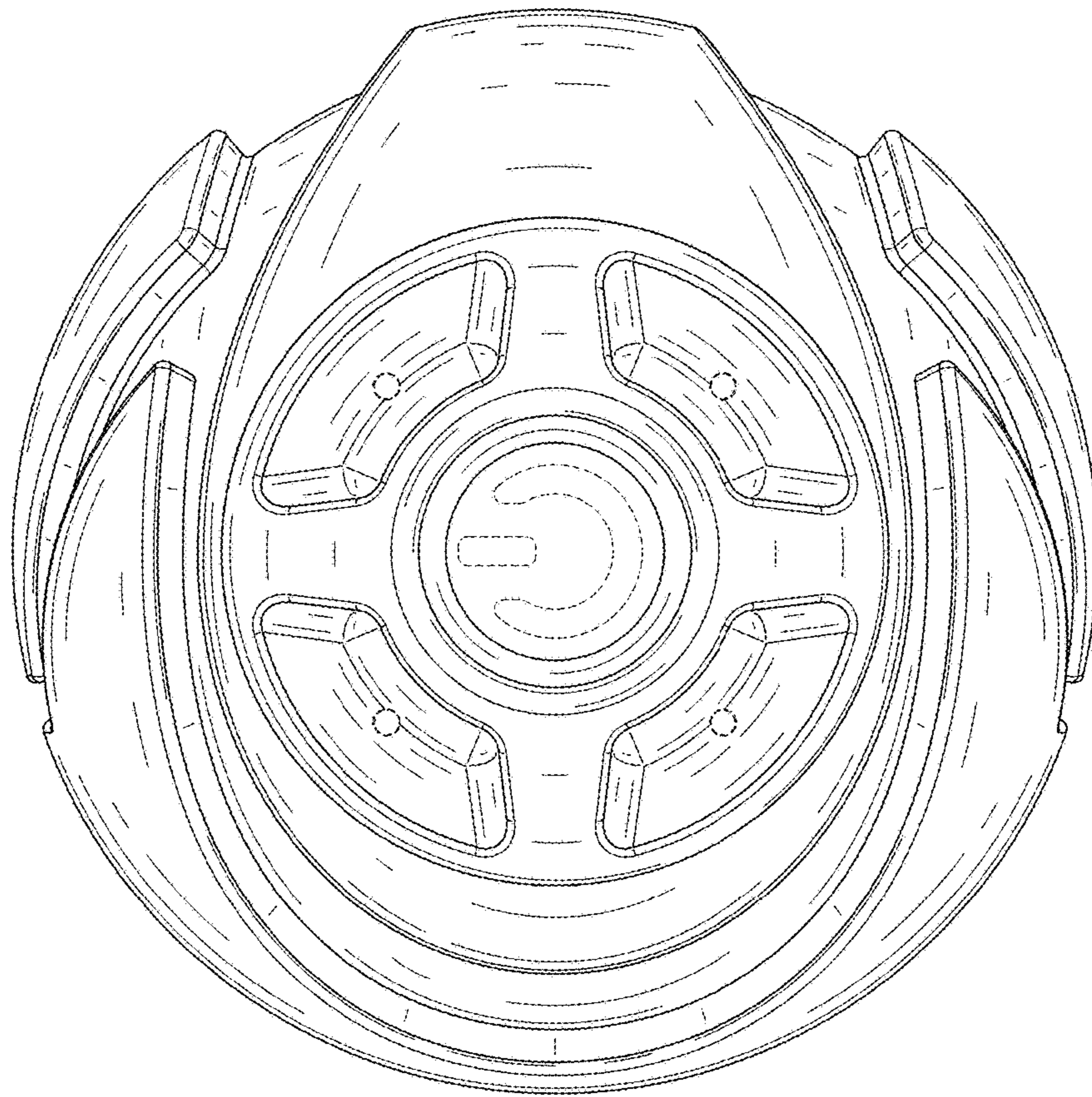

FIG. 18