



US00D848592S

(12) **United States Design Patent**
Zhang

(10) **Patent No.:** **US D848,592 S**

(45) **Date of Patent:** **** May 14, 2019**

(54) **AIR CONDITIONER**

(71) Applicants: **GD MIDEA AIR-CONDITIONING EQUIPMENT CO., LTD.**, Foshan (CN); **MIDEA GROUP CO., LTD.**, Foshan (CN)

(72) Inventor: **Quanfan Zhang**, Foshan (CN)

(73) Assignees: **GD MIDEA AIR-CONDITIONING EQUIPMENT CO., LTD.**, Foshan (CN); **MIDEA GROUP CO., LTD.**, Foshan (CN)

(**) Term: **15 Years**

(21) Appl. No.: **29/621,257**

(22) Filed: **Oct. 5, 2017**

(30) **Foreign Application Priority Data**

Sep. 28, 2017 (CN) 2017 3 0467275

(51) **LOC (11) Cl.** **23-04**

(52) **U.S. Cl.**
USPC **D23/351**

(58) **Field of Classification Search**

USPC D23/333, 335, 341, 342, 351, 353, 354,
D23/355, 356, 359, 364, 365, 370, 385,
D23/386, 388, 393

CPC F24F 1/00; F24F 1/0007; F24F 1/02; F24F
1/08; F24F 1/42; F24F 1/56; F24F 1/60;
F24F 3/044; F24F 3/048; F24F 3/16;
F24F 7/00; F24F 7/04; F24F 12/001;
F24F 12/006

See application file for complete search history.

(56) **References Cited**

U.S. PATENT DOCUMENTS

D394,098 S * 5/1998 Cho D23/351
D465,017 S * 10/2002 Choi D23/353

D465,273 S * 11/2002 Yoo D23/353
D465,563 S * 11/2002 Lee D23/353
D474,533 S * 5/2003 Zhu D23/353
D495,408 S * 8/2004 Song D23/353
D523,944 S * 6/2006 Oh D23/353
D534,261 S * 12/2006 Oh D23/353
D534,638 S * 1/2007 Ryu D23/353
D558,868 S * 1/2008 Choi D23/353
D616,084 S * 5/2010 Lingrey D23/353
D777,896 S * 1/2017 Rizzi D23/354
D819,794 S * 6/2018 Yin D23/351
D819,795 S * 6/2018 Yin D23/351
D820,421 S * 6/2018 Yin D23/351
D820,961 S * 6/2018 Yin D23/351

* cited by examiner

Primary Examiner — Natasha Vujcic

(74) *Attorney, Agent, or Firm* — Kilpatrick Townsend & Stockton LLP

(57) **CLAIM**

I claim, the ornamental design for an air conditioner, as shown and described.

DESCRIPTION

FIG. 1 is a perspective view of an air conditioner, showing our new design;
FIG. 2 is a front view thereof;
FIG. 3 is a back view thereof;
FIG. 4 is a right side view thereof;
FIG. 5 is a left side view thereof;
FIG. 6 is a top view thereof; and,
FIG. 7 is a bottom view thereof.

The broken lines in the drawings illustrate portions of the air conditioner which form no part of the claimed design.

1 Claim, 7 Drawing Sheets

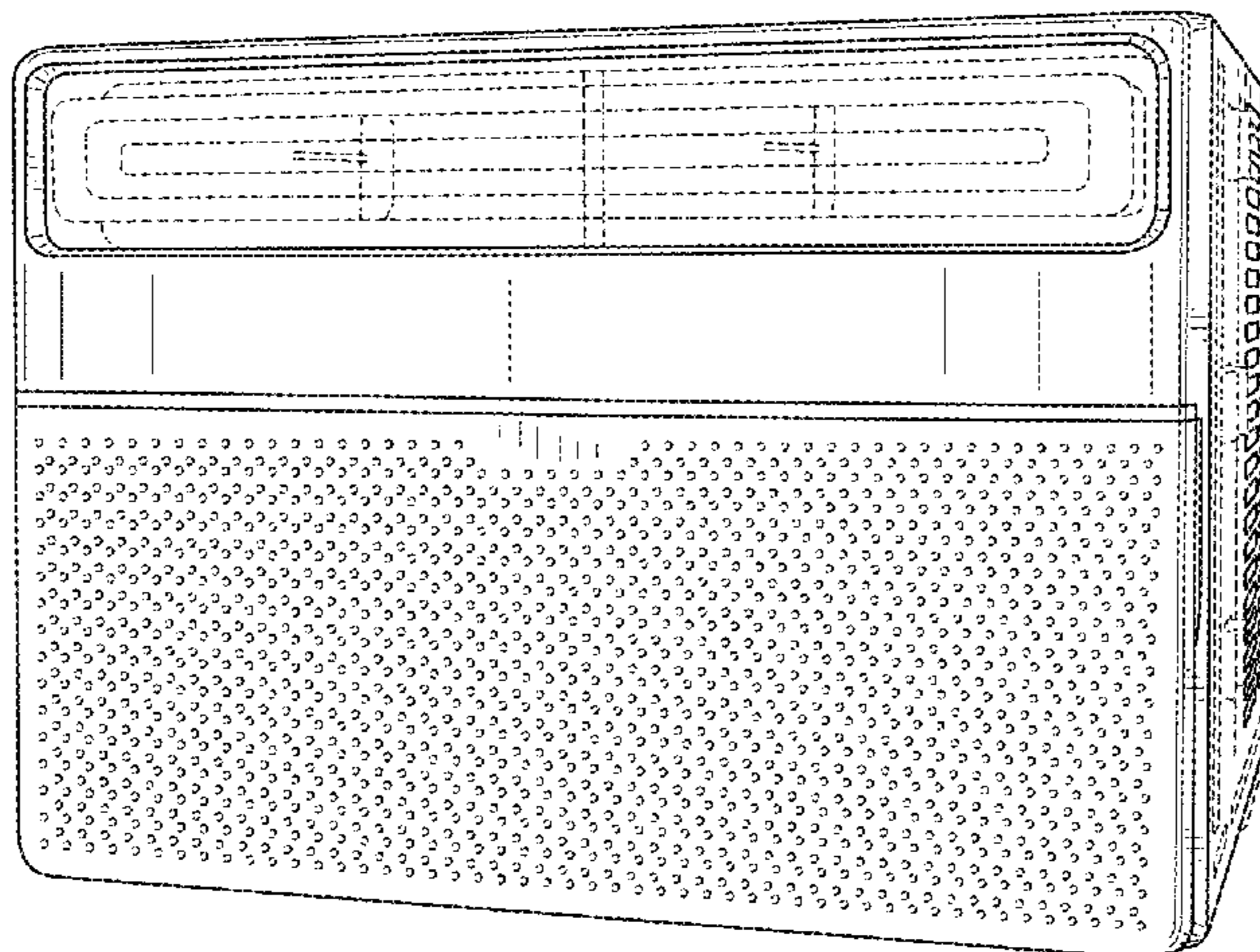

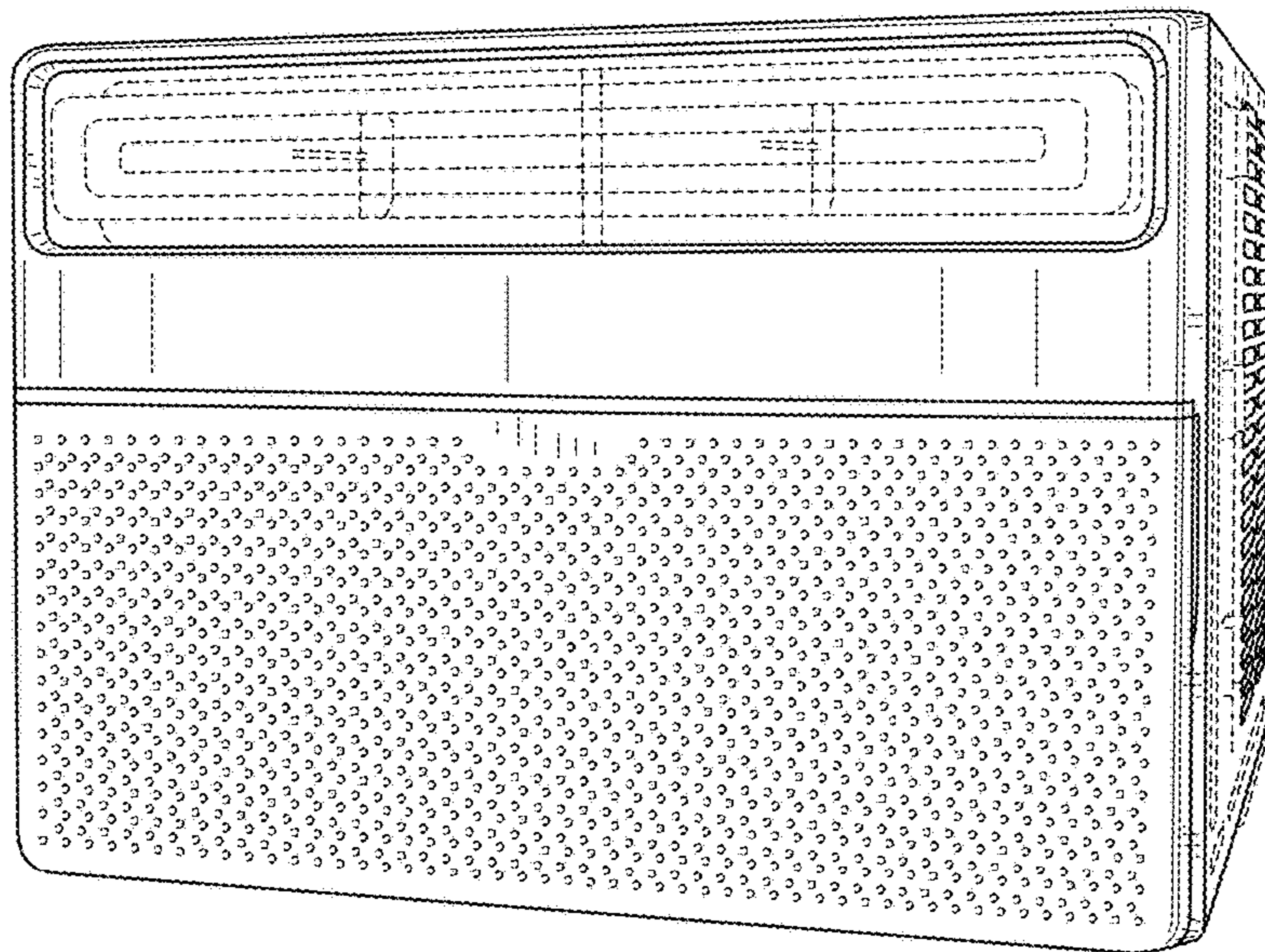

FIG.1

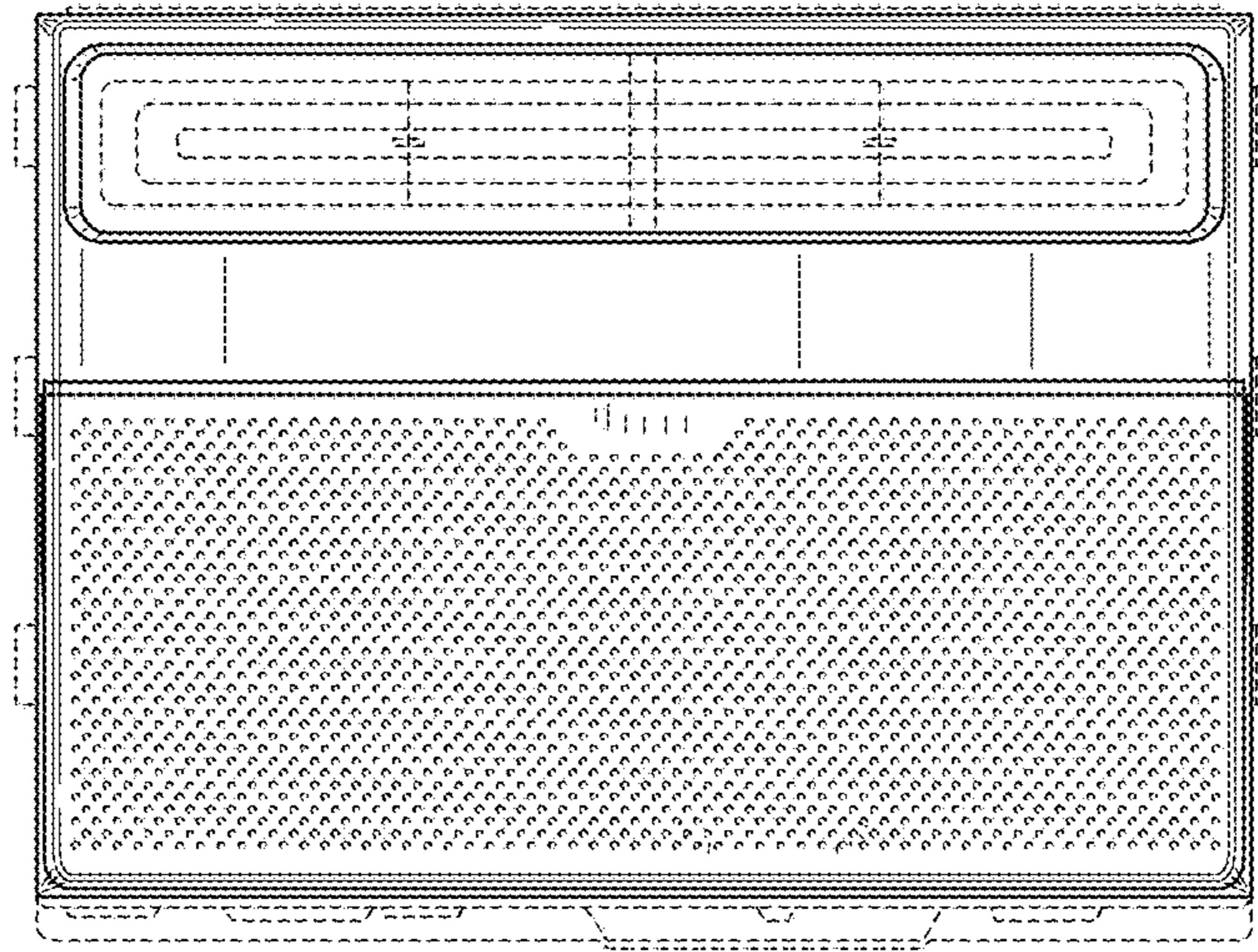

FIG.2

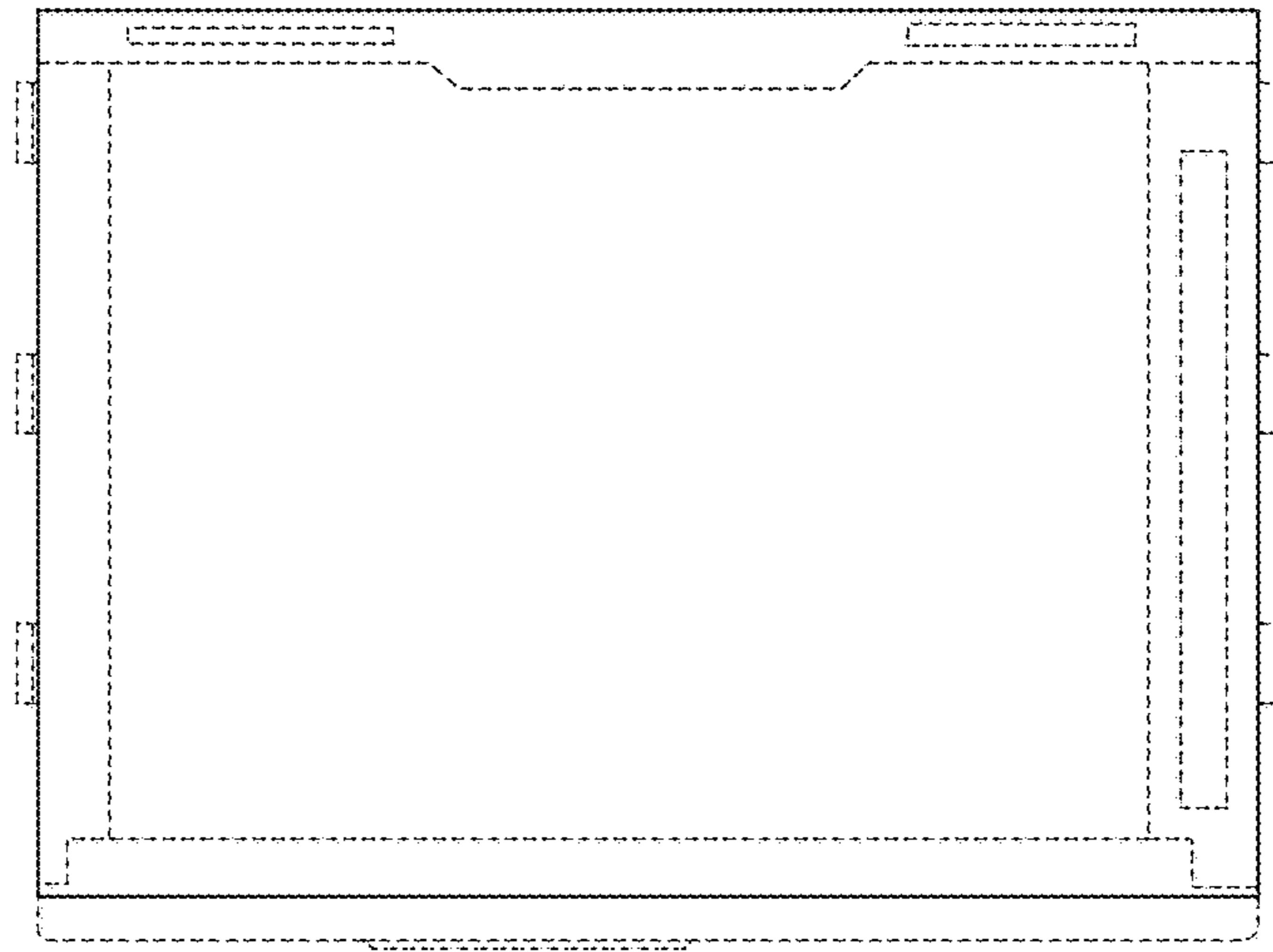

FIG.3

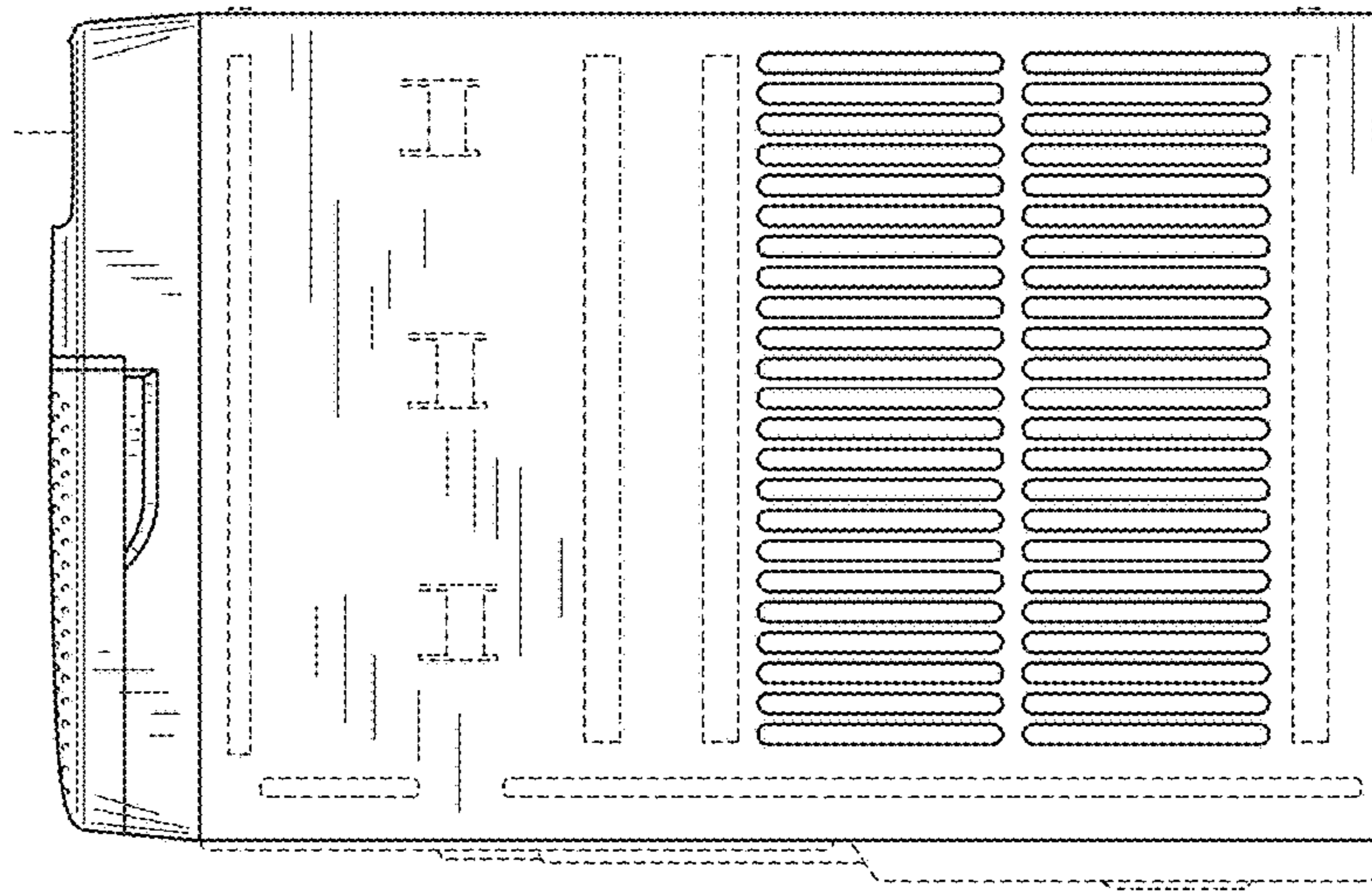

FIG.4

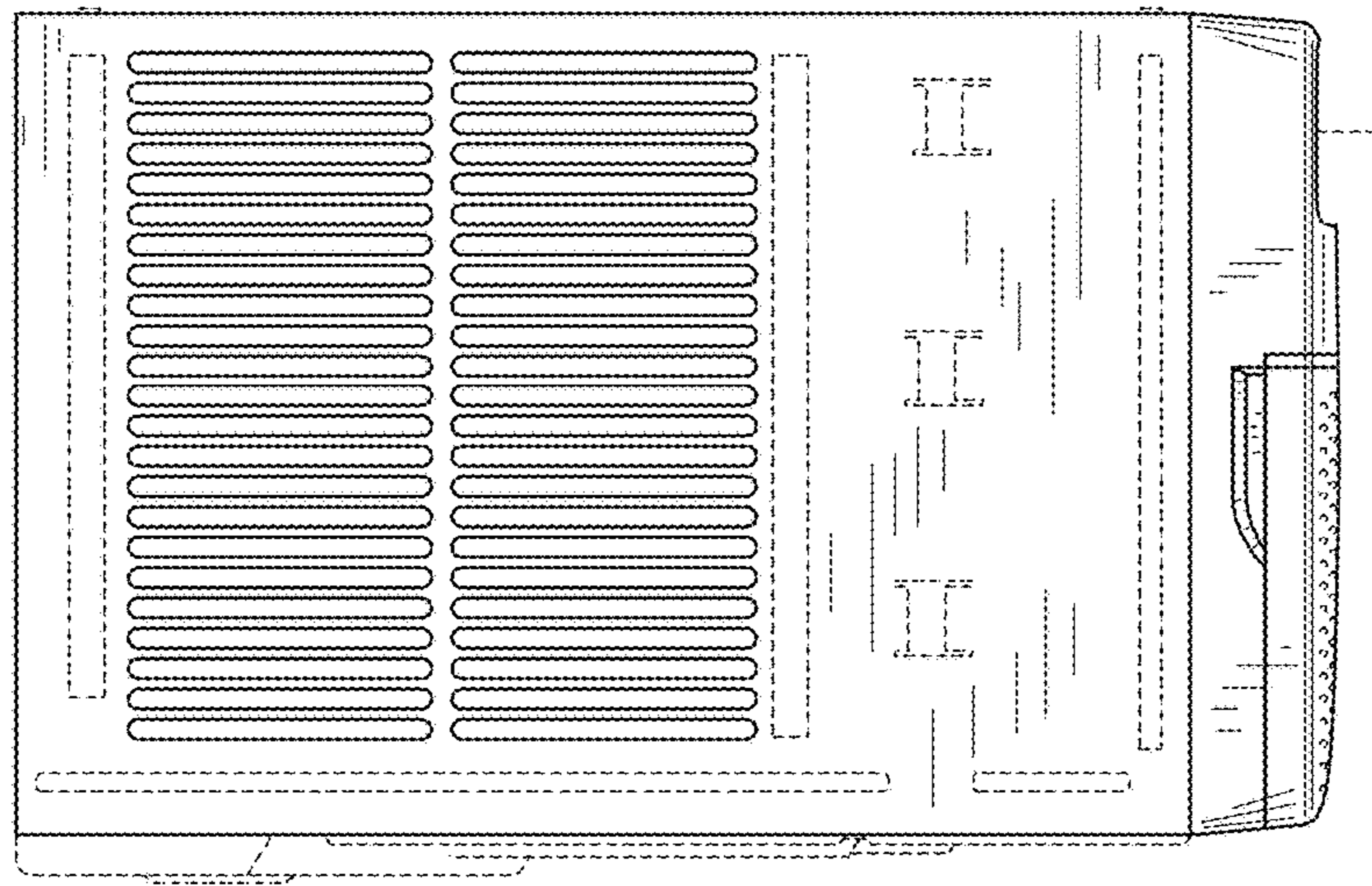

FIG.5

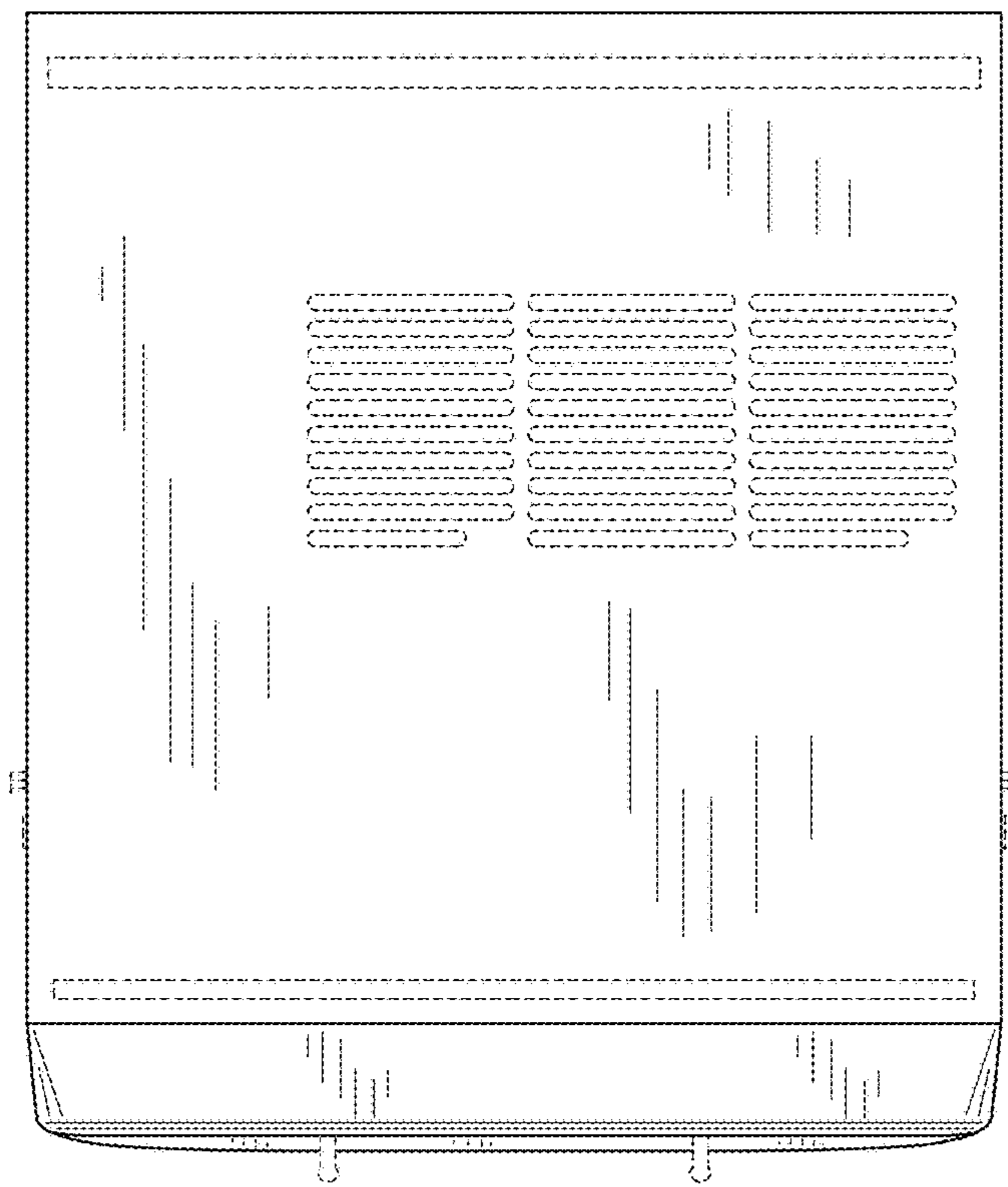

FIG.6

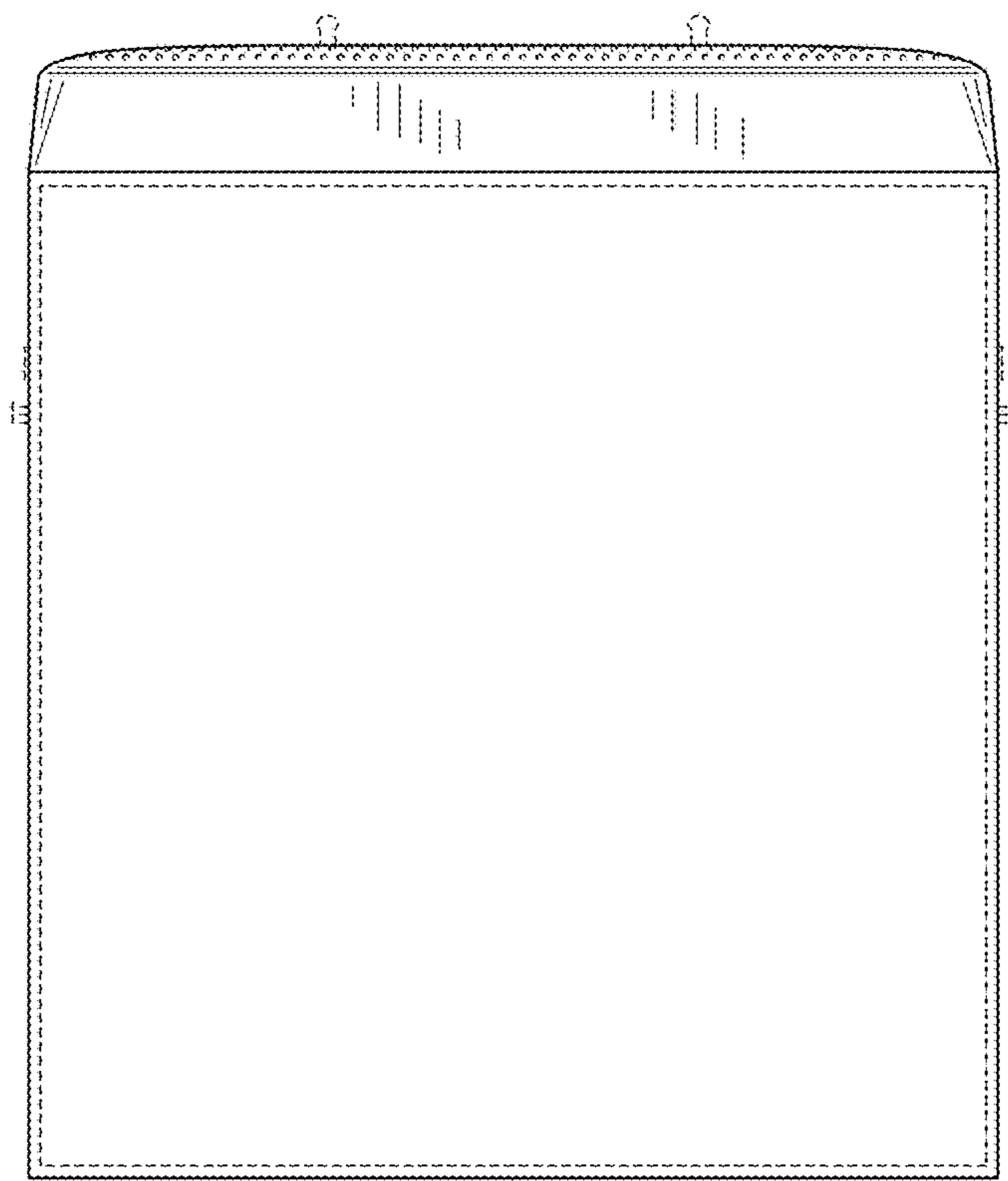

FIG.7