



US00D848562S

(12) **United States Design Patent** (10) **Patent No.:** **US D848,562 S**
Nicolette et al. (45) **Date of Patent:** **** *May 14, 2019**

(54) **GOLF CLUB HEAD**

OTHER PUBLICATIONS

- (71) Applicant: **PARSONS XTREME GOLF, LLC**,
Scottsdale, AZ (US)
- (72) Inventors: **Michael R. Nicolette**, Scottsdale, AZ
(US); **Bradley D. Schweigert**, Anthem,
AZ (US)
- (73) Assignee: **PARSONS XTREME GOLF, LLC**,
Scottsdale, AZ (US)
- (*) Notice: This patent is subject to a terminal dis-
claimer.
- (**) Term: **15 Years**
- (21) Appl. No.: **29/619,130**
- (22) Filed: **Sep. 27, 2017**

U.S. Appl. No. 29/523,587, Schweigert, "Golf Club Head," filed
Apr. 10, 2015.

(Continued)

Primary Examiner — Mitchell I. Siegel

(57) **CLAIM**

The ornamental design for a golf club head, as shown and
described.

DESCRIPTION

FIG. 1 is a top perspective view of a golf club head;
FIG. 2 is a bottom perspective view of the golf club head of
FIG. 1;
FIG. 3 is a front elevational view of the golf club head of
FIG. 1;
FIG. 4 is a rear elevational view of the golf club head of FIG.
1;
FIG. 5 is a top view of the golf club head of FIG. 1;
FIG. 6 is a bottom view of the golf club head of FIG. 1;
FIG. 7 is a left side view of the golf club head of FIG. 1;
FIG. 8 is a right side view of the golf club head of FIG. 1;
FIG. 9 is a top perspective view of a golf club head;
FIG. 10 is a bottom perspective view of the golf club head
of FIG. 9;
FIG. 11 is a front elevational view of the golf club head of
FIG. 9;
FIG. 12 is a rear elevational view of the golf club head of
FIG. 9;
FIG. 13 is a top view of the golf club head of FIG. 9;
FIG. 14 is a bottom view of the golf club head of FIG. 9;
FIG. 15 is a left side view of the golf club head of FIG. 9;
and,
FIG. 16 is a right side view of the golf club head of FIG. 9.
The broken lines are included for the purpose of illustration
only. None of the broken lines forms part of the claimed
design.

Related U.S. Application Data

- (63) Continuation-in-part of application No. 29/599,081,
filed on Mar. 30, 2017, which is a
(Continued)
- (51) **LOC (11) Cl.** **21-02**
- (52) **U.S. Cl.**
USPC **D21/736**
- (58) **Field of Classification Search**
USPC D21/736-746, 759
(Continued)

(56) **References Cited**

U.S. PATENT DOCUMENTS

- 922,444 A 5/1909 Youds
 - RE19,178 E 5/1934 Spiker
- (Continued)

FOREIGN PATENT DOCUMENTS

- JP 2005/160691 A 6/2005

1 Claim, 12 Drawing Sheets

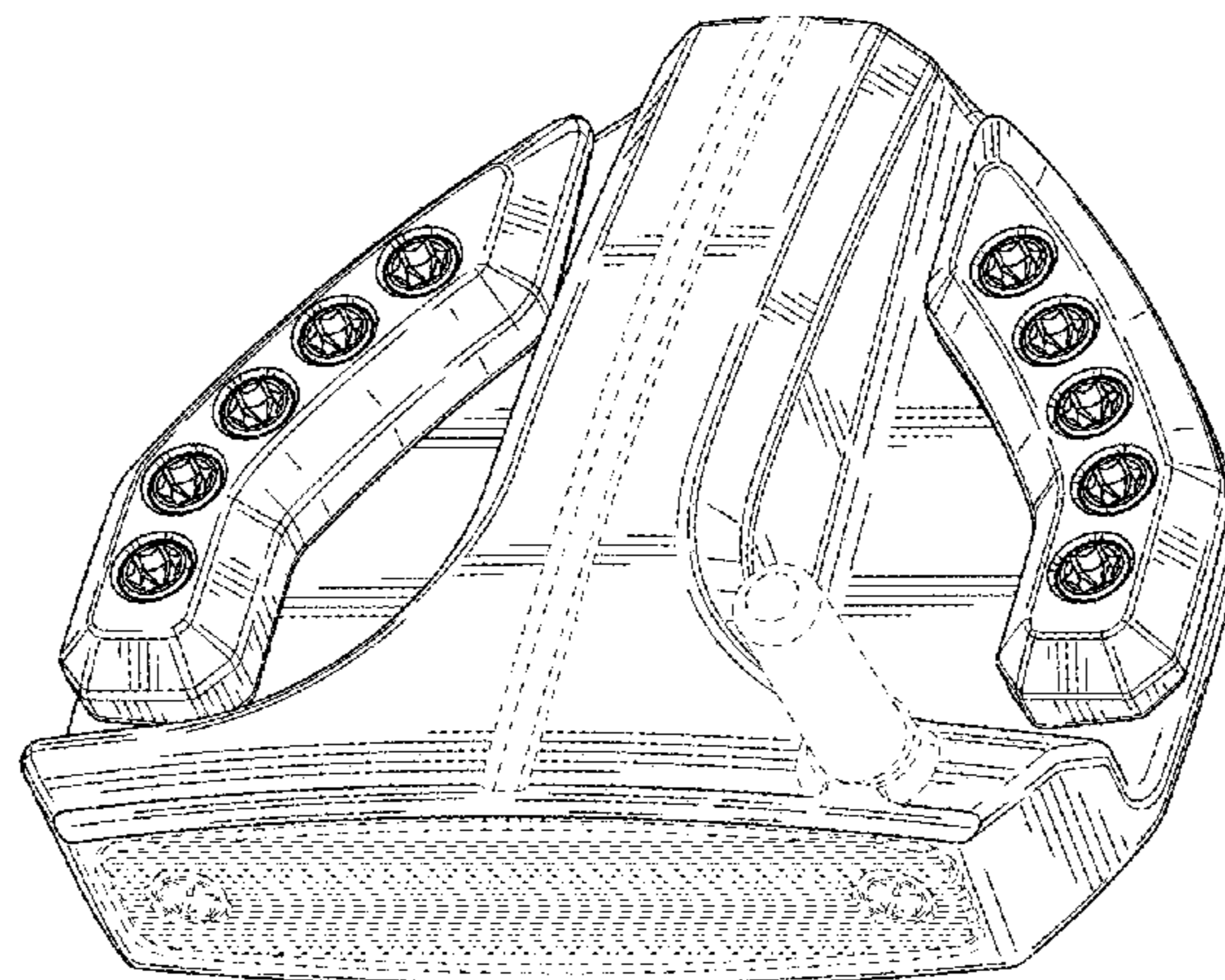

Related U.S. Application Data

continuation-in-part of application No. 29/550,730,
filed on Jan. 6, 2016, now Pat. No. Des. 783,101.

(58) **Field of Classification Search**

CPC A63B 53/00; A63B 53/04; A63B 53/007;
A63B 53/065; A63B 53/0487; A63B
60/00; A63B 60/46

See application file for complete search history.

(56)

References Cited

U.S. PATENT DOCUMENTS

4,043,562 A 8/1977 Shillington
4,754,977 A 7/1988 Sahn
4,869,507 A 9/1989 Sahn
D335,317 S 5/1993 Shearer
D335,692 S 5/1993 Antonious
D336,757 S 6/1993 Antonious
D350,582 S 9/1994 Miansian et al.
5,429,366 A 7/1995 McCabe
D363,101 S 10/1995 Sturm
D365,864 S 1/1996 Sturm
5,489,097 A 2/1996 Simmons
D368,751 S 4/1996 Rife
D369,393 S 4/1996 Takahashi et al.
5,571,053 A 11/1996 Lane
D378,688 S 4/1997 Cameron
D385,609 S 10/1997 Cameron
5,683,307 A 11/1997 Rife
D388,143 S 12/1997 Huan-Chiang
D389,207 S 1/1998 Cameron
D396,685 S 9/1998 Masuda
D399,290 S 10/1998 Sizemore, Jr.
D399,911 S 10/1998 Nicolette et al.
5,839,974 A 11/1998 McAllister
D405,836 S 2/1999 Nicolette et al.
D409,701 S 5/1999 Ashcraft et al.
5,924,938 A 7/1999 Hines
D422,655 S 4/2000 Hicks
D426,276 S 6/2000 Besnard et al.
D431,854 S 10/2000 Cameron
D432,192 S 10/2000 Hicks
D436,151 S 1/2001 Nicolette et al.
D437,374 S 2/2001 Cameron
D441,820 S 5/2001 Nicolette et al.
D443,668 S 6/2001 Nicolette et al.
D443,905 S 6/2001 Nicolette et al.
D444,833 S 7/2001 Wells et al.
6,264,571 B1 7/2001 Lekavich
D449,664 S 10/2001 Beebe et al.
D449,865 S 10/2001 Fife, Jr. et al.
D450,799 S 11/2001 Nicolette et al.
D451,973 S 12/2001 Wells et al.
6,348,014 B1 2/2002 Chiu
6,354,959 B1 3/2002 Nicolette et al.
6,394,910 B1 5/2002 McCarthy
D472,949 S 4/2003 Serrano
D474,821 S 5/2003 Wells et al.
D474,949 S 5/2003 Schaffeld et al.
D483,086 S 12/2003 Schweigert et al.
D486,872 S 2/2004 Schweigert et al.
D488,200 S * 4/2004 Olsavsky D21/743
D498,276 S 11/2004 Schweigert et al.
6,902,496 B2 6/2005 Solheim et al.
D512,116 S 11/2005 Mirafflor et al.
6,988,956 B2 1/2006 Cover et al.
D520,088 S 5/2006 Parr
D531,242 S 10/2006 Adams
D532,067 S 11/2006 Soracco et al.
7,153,220 B2 12/2006 Lo
D534,595 S 1/2007 Hasebe
7,156,752 B1 1/2007 Bennett
D536,401 S 2/2007 Kawami
D536,403 S 2/2007 Kawami
D538,371 S 3/2007 Kawami

7,204,765 B2 4/2007 Cover et al.
D542,869 S 5/2007 Adams
D543,598 S 5/2007 Kuan et al.
D543,601 S 5/2007 Kawami
D555,219 S 11/2007 Lin
D556,277 S 11/2007 Broom
D561,854 S 2/2008 Morris
7,331,876 B2 2/2008 Klein
7,351,162 B2 4/2008 Soracco et al.
D569,461 S 5/2008 Morris
D569,930 S 5/2008 Nehrbas
7,396,289 B2 7/2008 Soracco et al.
D577,085 S 9/2008 Nicolette et al.
D577,086 S 9/2008 Nicolette et al.
D579,506 S 10/2008 Nicolette et al.
D579,995 S 11/2008 Nicolette et al.
D582,497 S 12/2008 Rollinson
7,473,189 B2 1/2009 Schweigert et al.
7,491,131 B2 * 2/2009 Vinton A63B 53/0487
473/251
D595,793 S * 7/2009 Rollinson D21/736
D599,425 S 9/2009 Laub
D600,763 S 9/2009 Cameron
7,744,485 B2 6/2010 Jones et al.
D620,993 S 8/2010 Laub
D621,461 S * 8/2010 Serrano D12/742
D623,709 S 9/2010 Serrano et al.
D631,925 S 2/2011 Broom
7,887,432 B2 2/2011 Jones et al.
7,909,707 B2 3/2011 Klein
7,918,745 B2 4/2011 Morris et al.
D636,891 S 5/2011 Nicolette et al.
D642,643 S 8/2011 Nicolette et al.
D643,485 S * 8/2011 Nicolette D21/736
D645,104 S 9/2011 Nicolette et al.
8,096,039 B2 1/2012 Soracco et al.
D653,718 S * 2/2012 Stokke D21/743
D661,753 S 6/2012 Cameron et al.
D666,260 S * 8/2012 Cynn D21/742
8,376,878 B2 2/2013 Bennett et al.
D688,339 S 8/2013 Hilton et al.
D688,341 S 8/2013 Rollinson
D691,226 S 10/2013 Hilton et al.
D699,308 S 2/2014 Rollinson
D704,782 S 5/2014 Rollinson
8,721,472 B2 5/2014 Kuan et al.
8,790,193 B2 7/2014 Serrano et al.
D711,483 S 8/2014 Wong
D715,388 S * 10/2014 Serrano D21/743
D722,350 S * 2/2015 Schweigert D21/735
D722,351 S * 2/2015 Parsons D21/736
D722,352 S * 2/2015 Nicolette D21/747
D723,120 S * 2/2015 Nicolette D21/747
D724,164 S * 3/2015 Schweigert D21/752
D725,208 S * 3/2015 Schweigert D21/743
D726,265 S * 4/2015 Nicolette D21/747
D726,846 S * 4/2015 Schweigert D21/743
D730,462 S * 5/2015 Becktor D21/742
D732,122 S * 6/2015 Becktor D21/742
D732,618 S * 6/2015 Becktor D21/742
D733,234 S * 6/2015 Nicolette D21/752
D738,447 S * 9/2015 Schweigert D21/736
D738,449 S * 9/2015 Schweigert D21/759
D739,487 S 9/2015 Schweigert
D741,426 S * 10/2015 Schweigert D21/736
D748,213 S * 1/2016 Parsons D21/742
D748,215 S * 1/2016 Parsons D21/759
9,233,283 B2 1/2016 Schweigert
D750,186 S * 2/2016 Schweigert D21/746
D753,252 S * 4/2016 Schweigert D21/759
9,440,124 B2 9/2016 Parsons et al.
D774,607 S * 12/2016 Serrano D21/743
D774,610 S * 12/2016 Serrano D21/744
D777,267 S * 1/2017 Dolezel D21/742
D777,269 S * 1/2017 Becktor D21/742
D783,101 S * 4/2017 Schweigert D21/736
D793,502 S * 8/2017 Cardani D21/743
D796,604 S * 9/2017 Serrano D21/744
D801,458 S * 10/2017 Rollinson D21/742

(56)

References Cited

U.S. PATENT DOCUMENTS

D812,164 S * 3/2018 Parsons D21/742
D815,703 S * 4/2018 Schweigert D21/736
D823,410 S * 7/2018 Parsons D21/759
2007/0142122 A1 6/2007 Bonneau
2007/0207875 A1 9/2007 Kuan et al.
2007/0238548 A1 10/2007 Johnson
2008/0139333 A1 6/2008 Klein
2008/0146372 A1 6/2008 John
2008/0176672 A1 7/2008 Roach et al.
2011/0165959 A1 7/2011 Klein
2013/0165256 A1 6/2013 Stevenson
2013/0210537 A1 8/2013 Ainscough et al.

OTHER PUBLICATIONS

TourSpecGolf (Gold's Factory Multi Weighted Custom Putter)
[online]. Nov. 20, 2010 [retrieved Apr. 21, 2016]. Retrieved from
the internet: <URL: <http://www.tourspecgolf.com/blog/golds-factory-multi-weighted-custom-putter/>>.

* cited by examiner

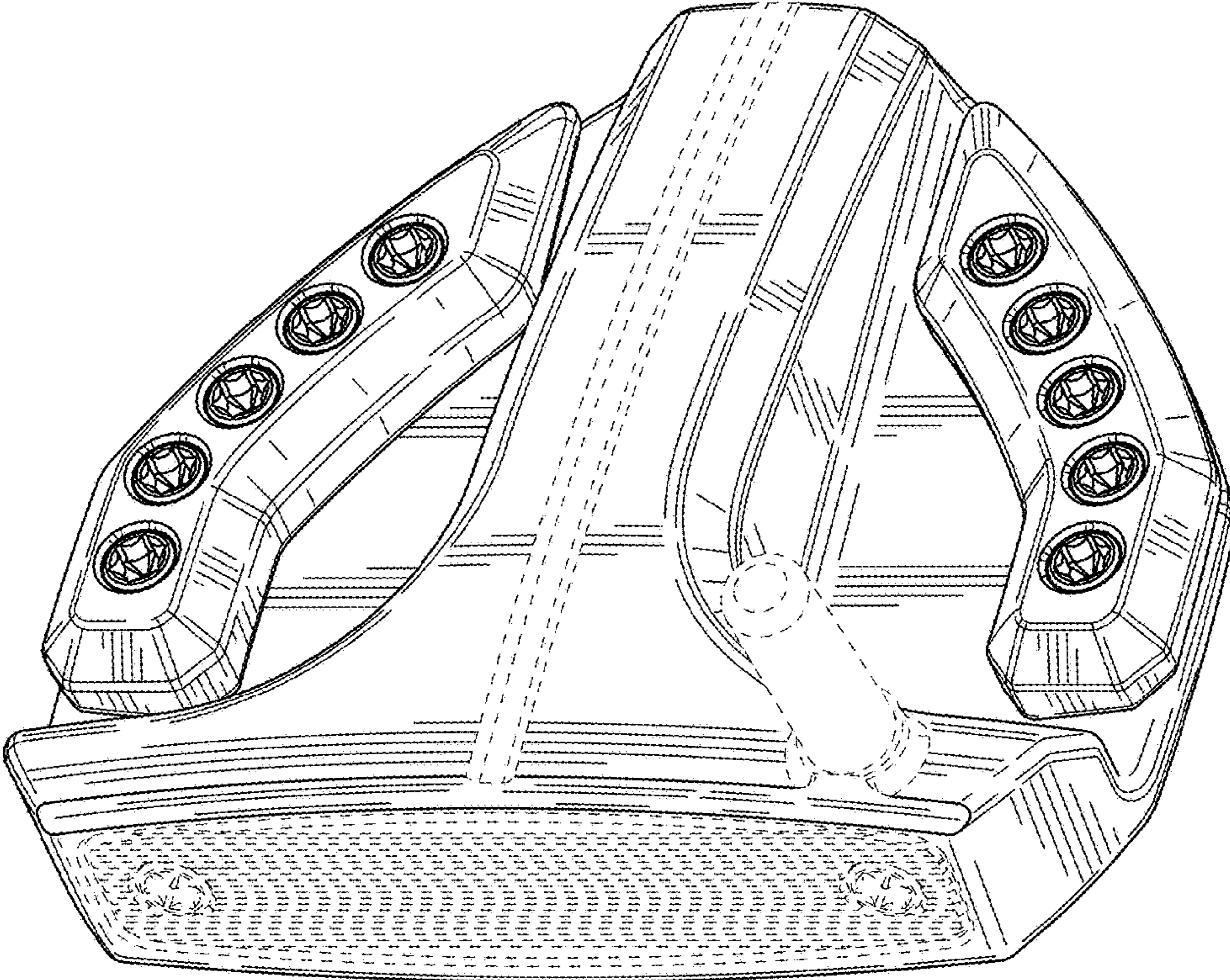

FIG. 1

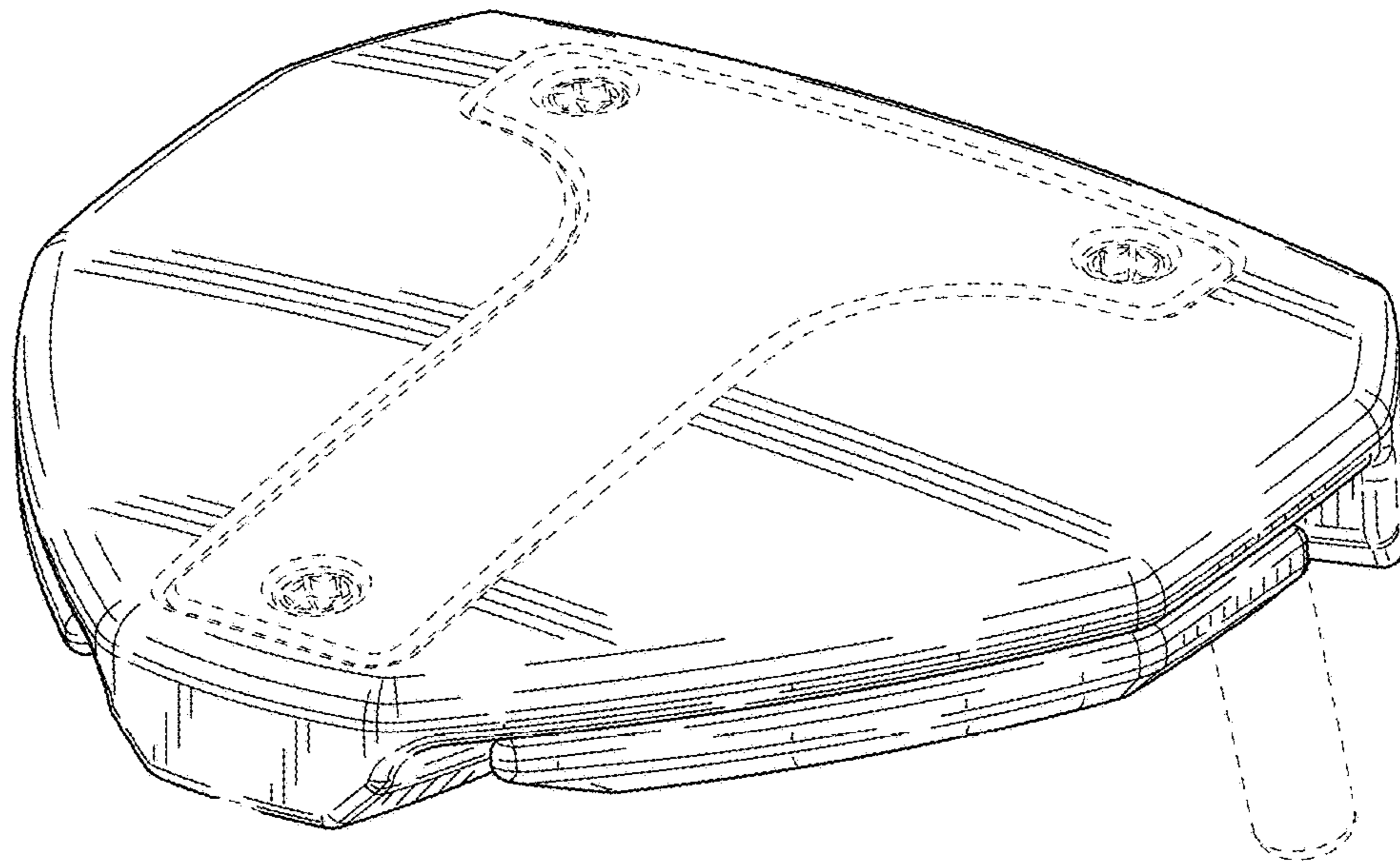

FIG. 2

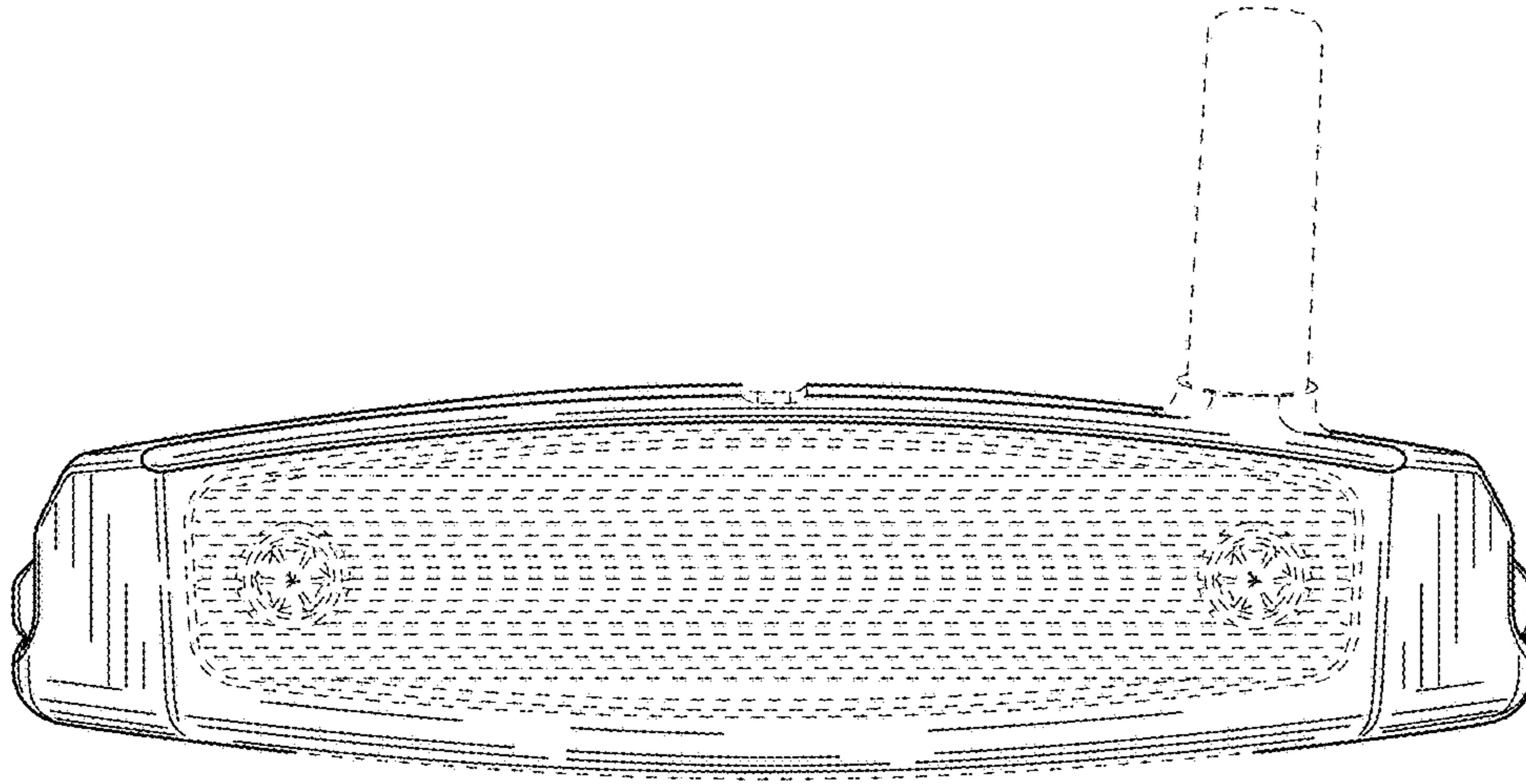

FIG. 3

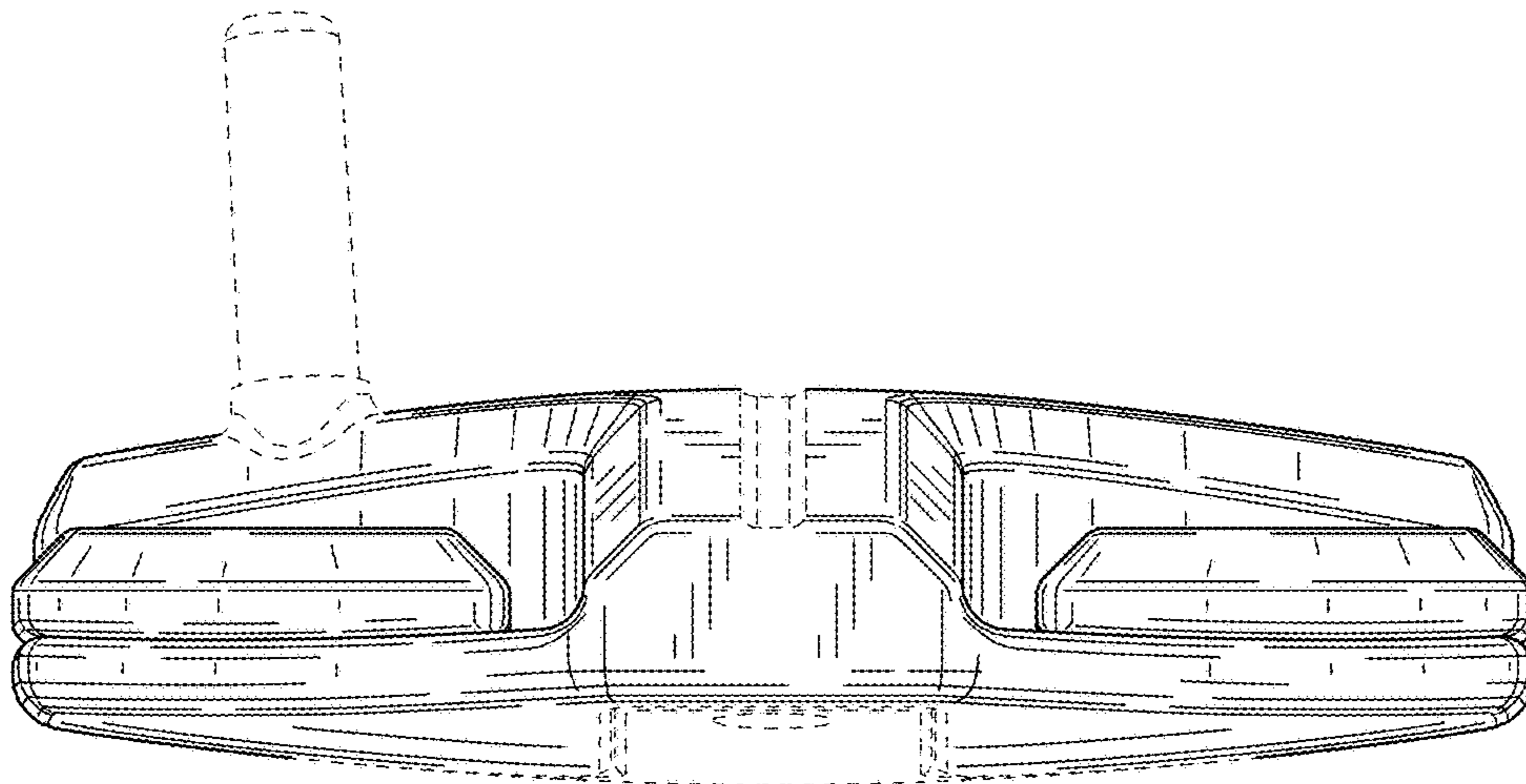

FIG. 4

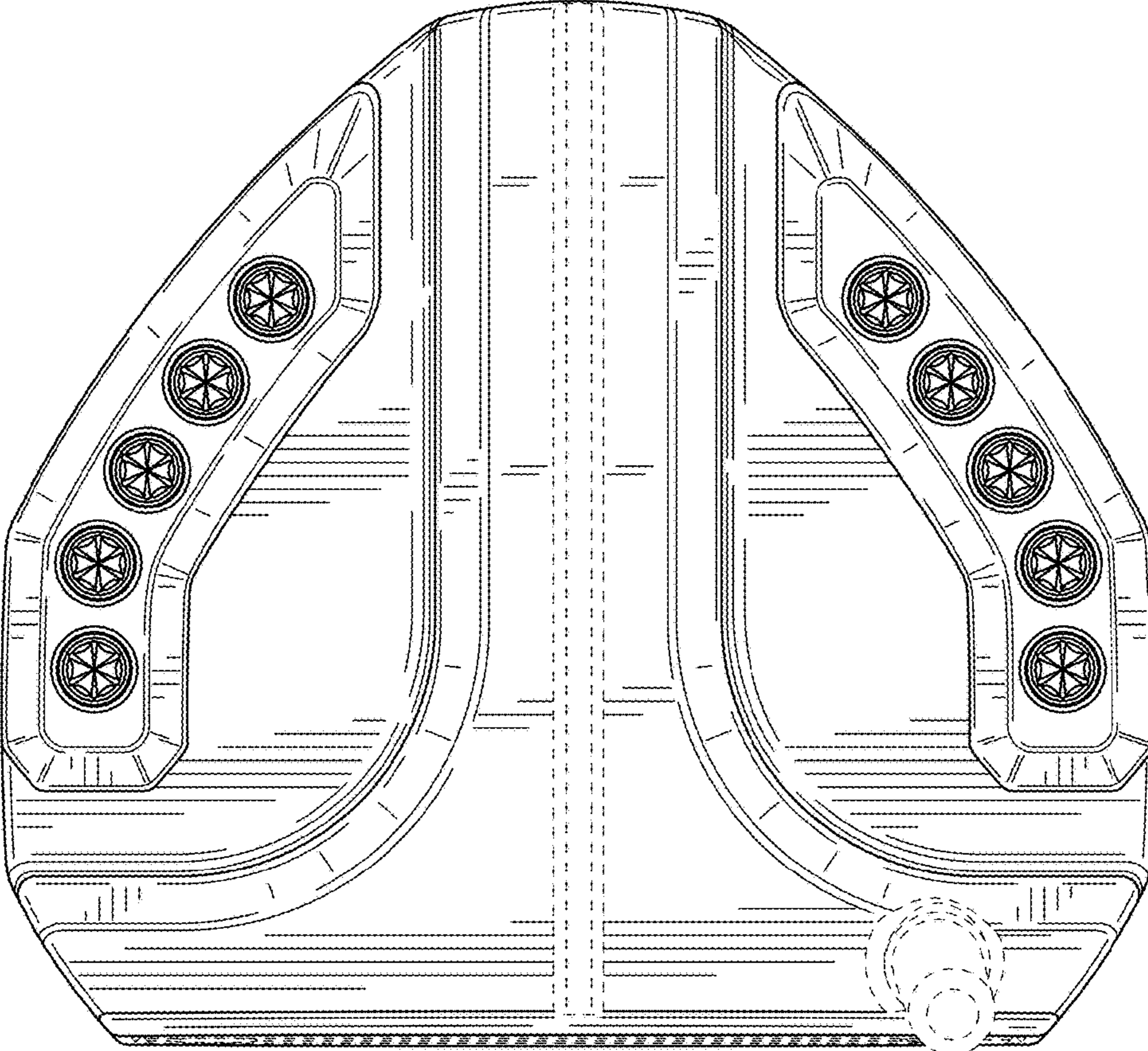

FIG. 5

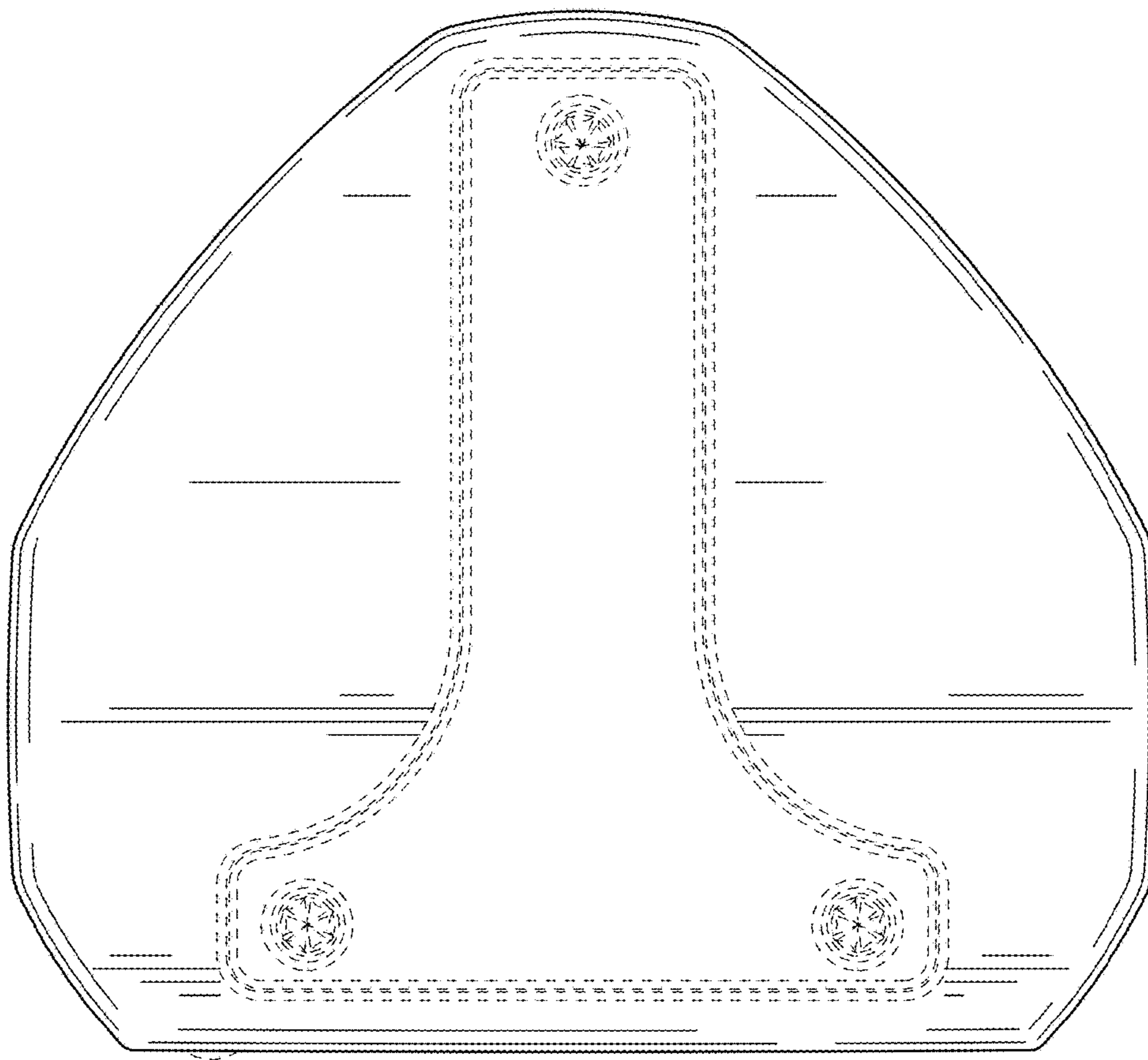

FIG. 6

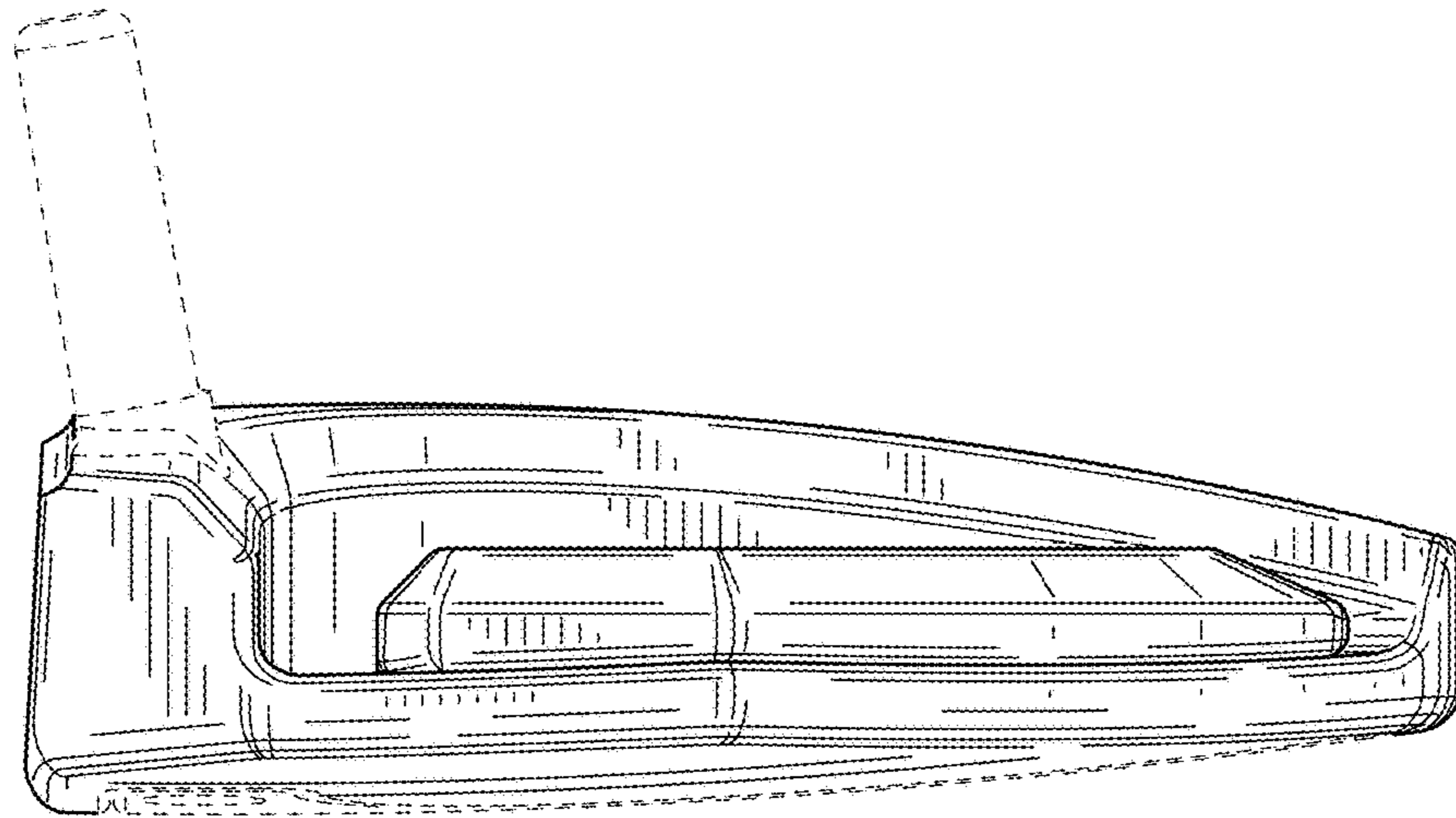

FIG. 7

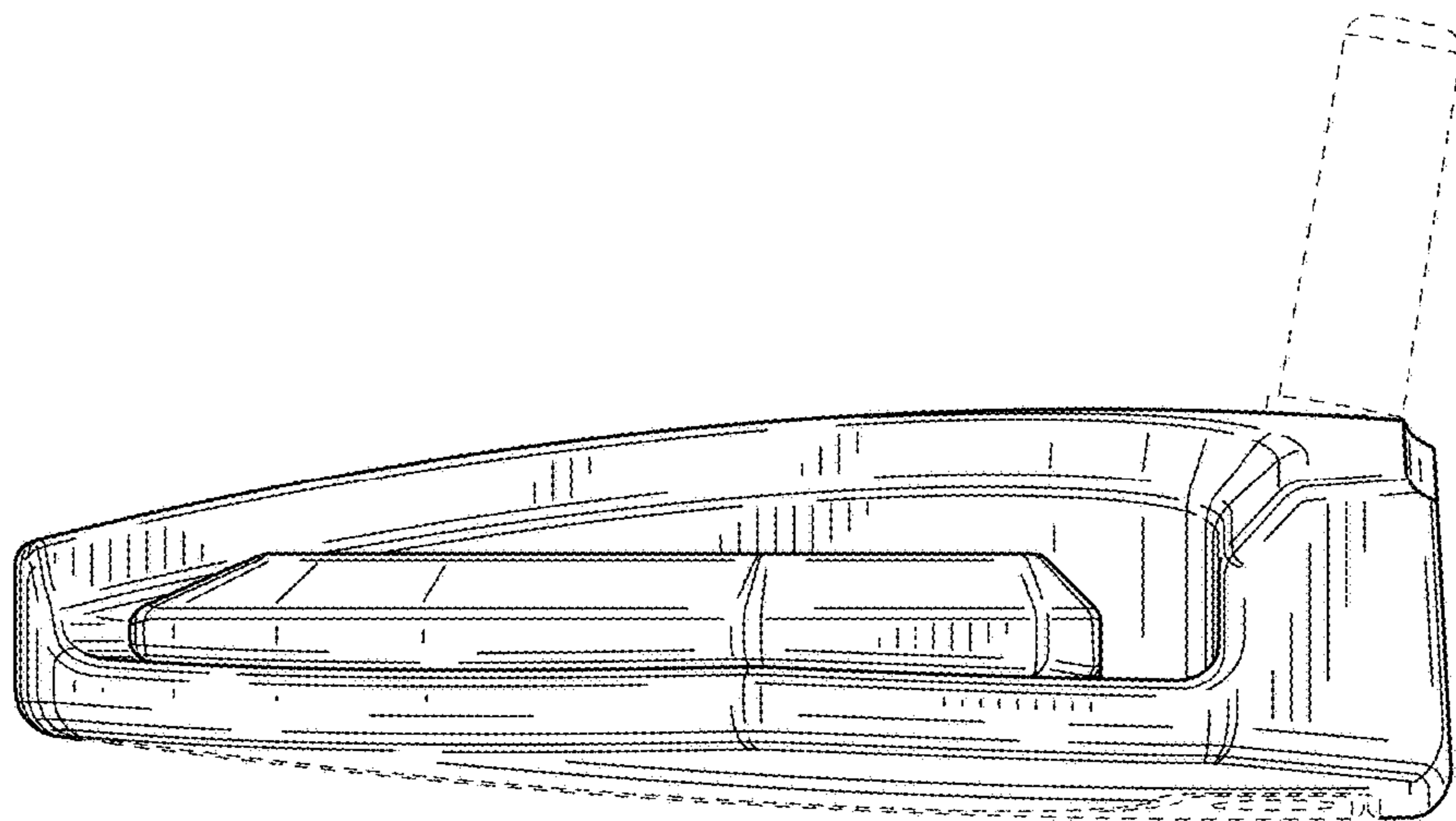

FIG. 8

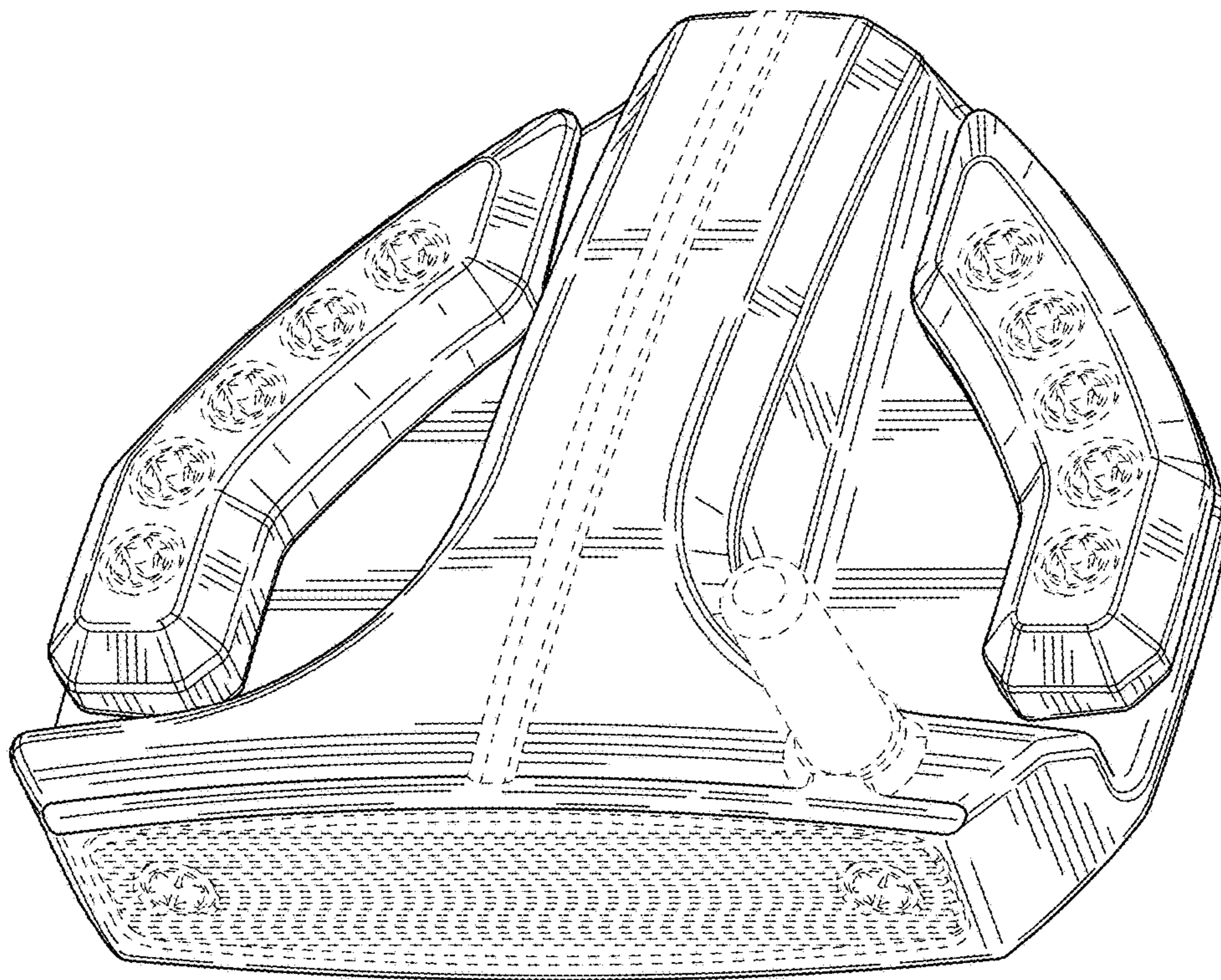

FIG. 9

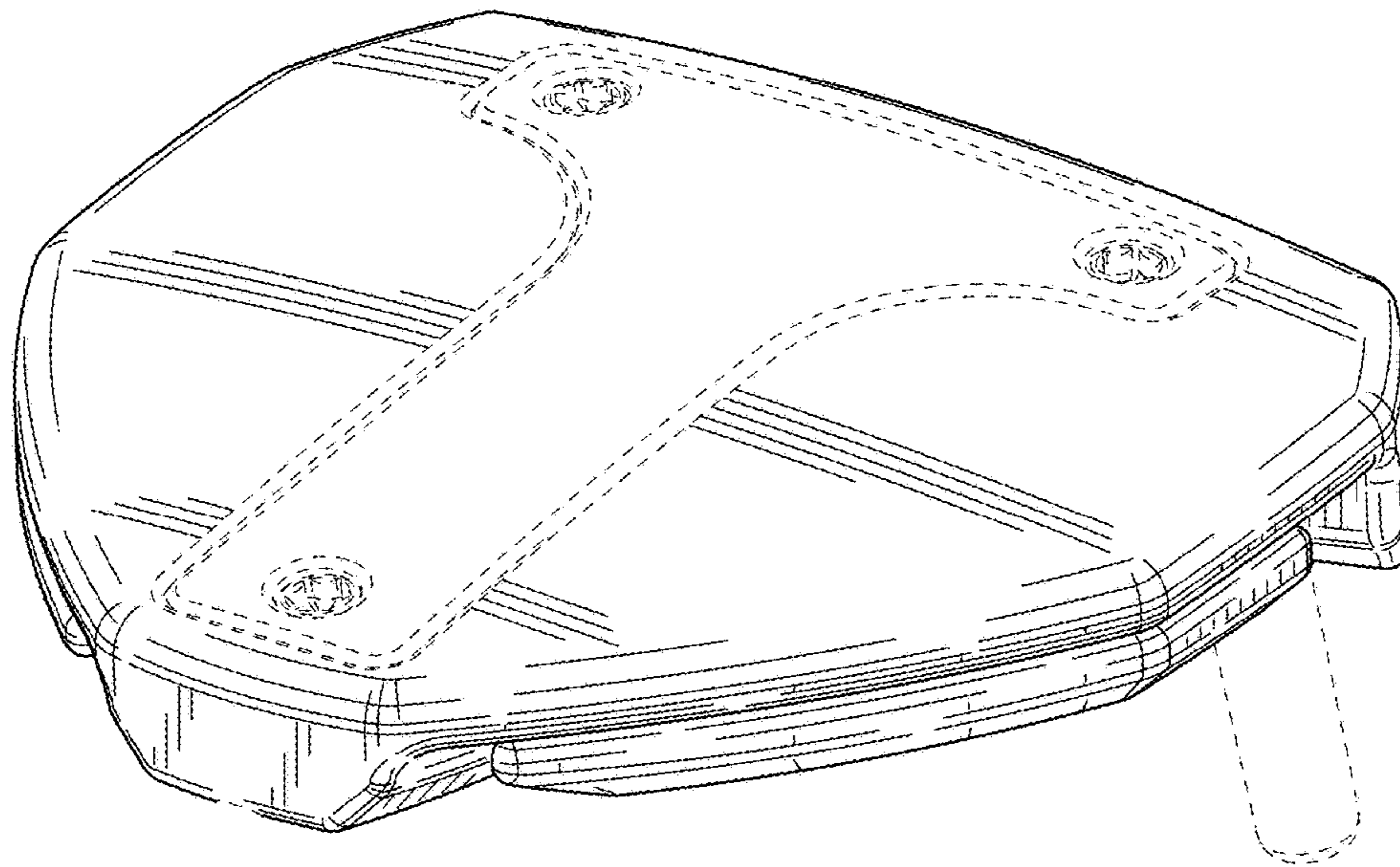

FIG. 10

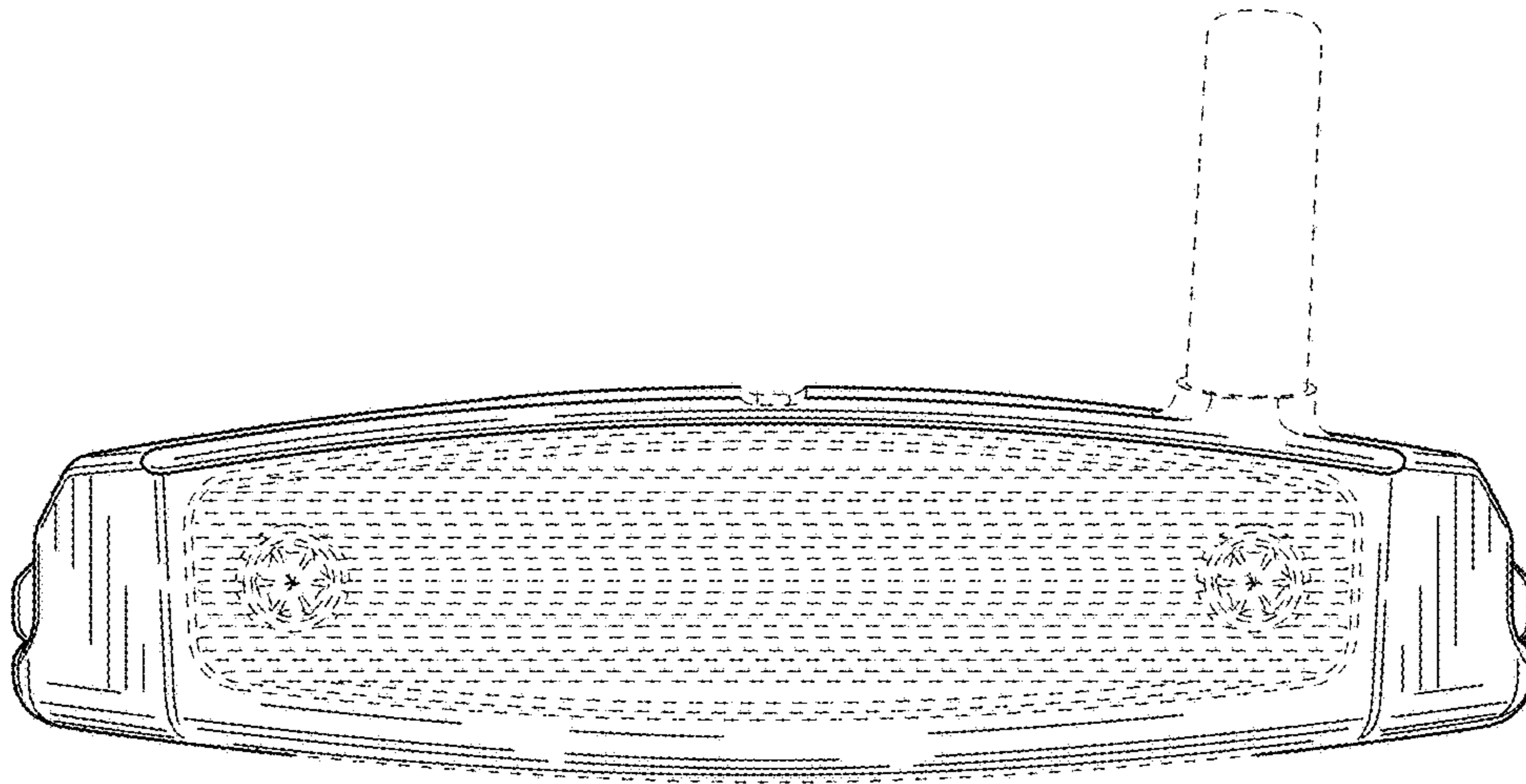

FIG. 11

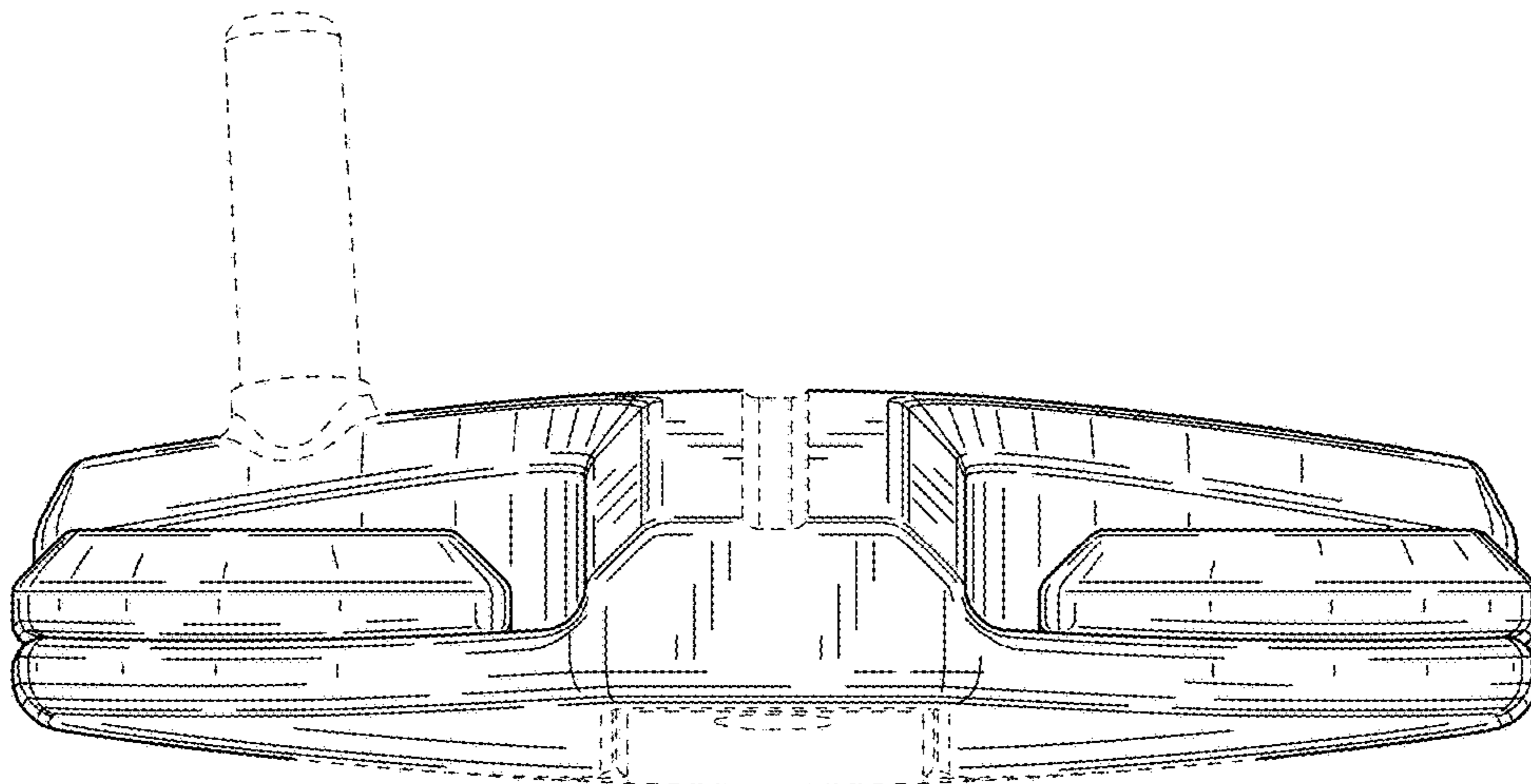

FIG. 12

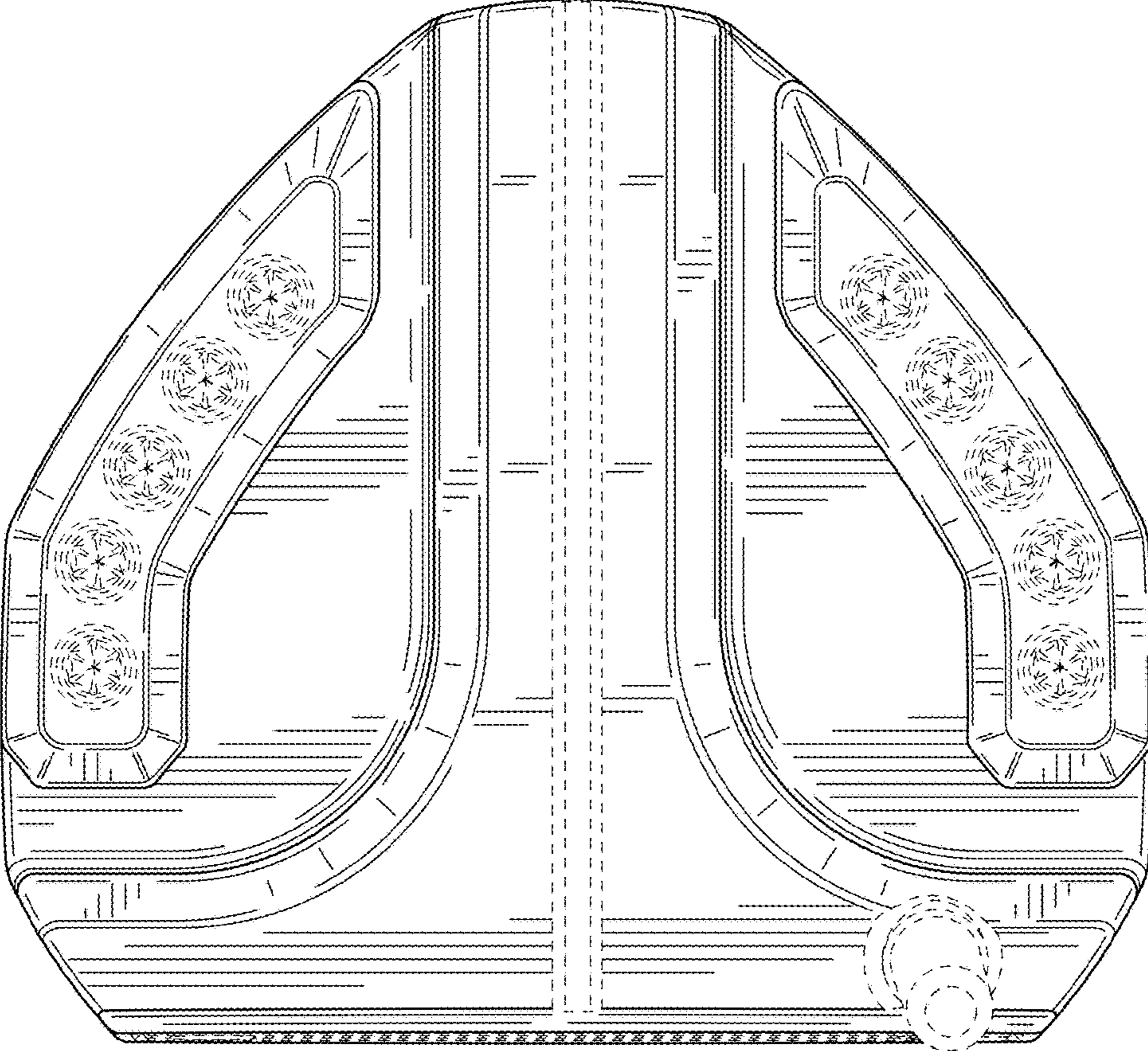

FIG. 13

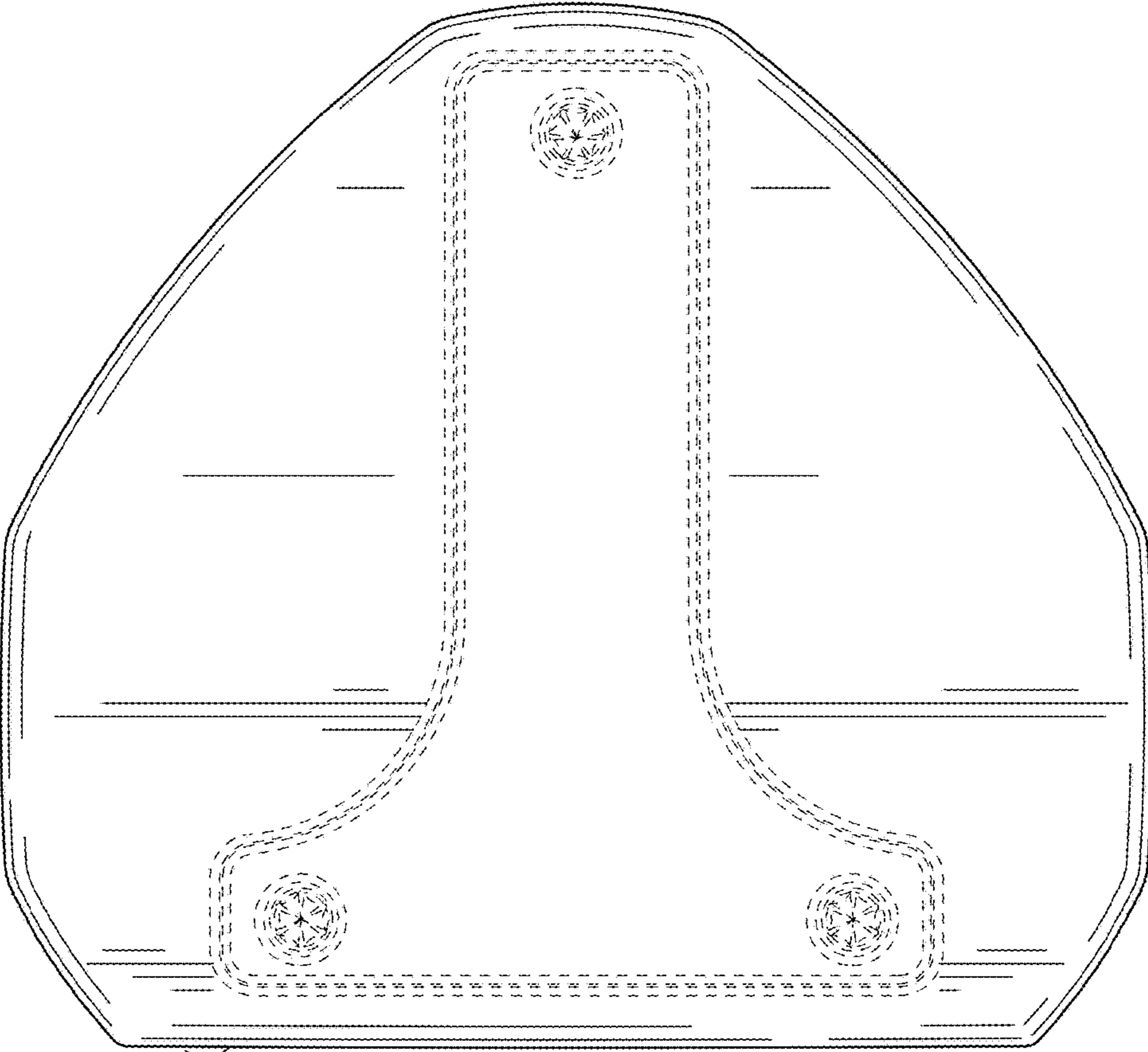

FIG. 14

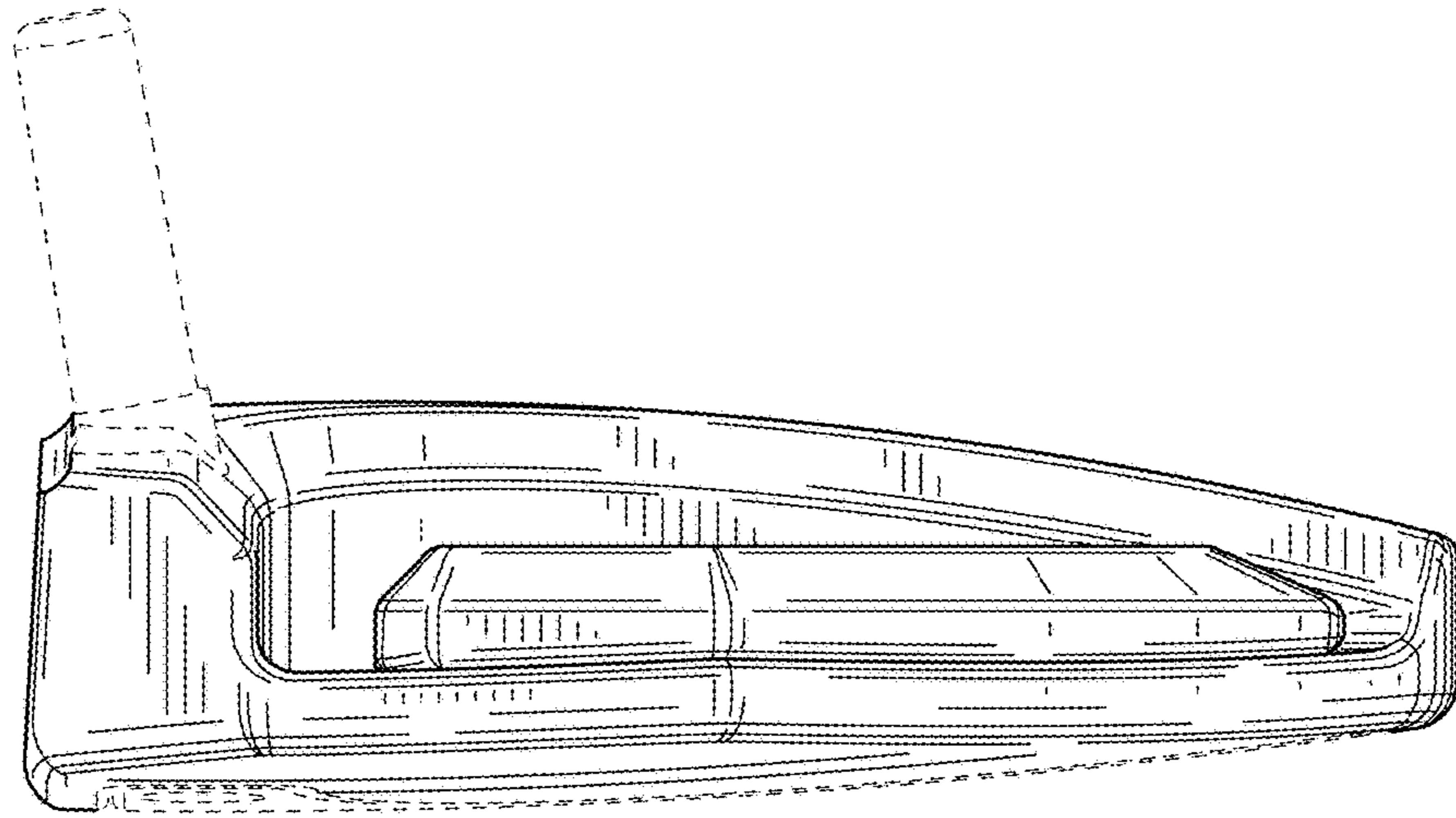

FIG. 15

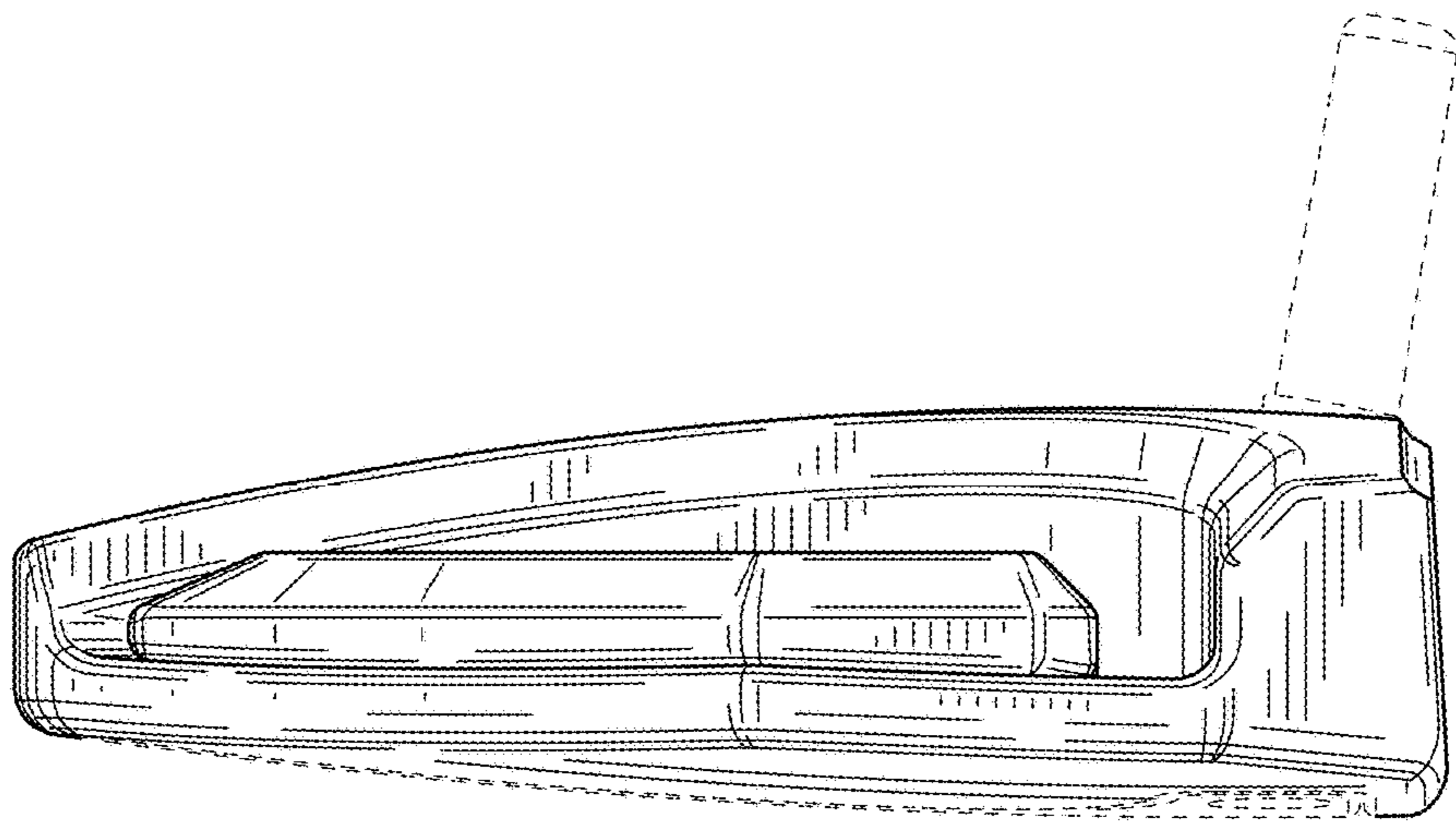

FIG. 16