



US00D848552S

(12) **United States Design Patent**
Cummings et al.

(10) **Patent No.:** **US D848,552 S**
(45) **Date of Patent:** **** May 14, 2019**

- (54) **POSABLE TOY HORSE**
- (71) Applicant: **KMA Concepts Limited**, Tsim Sha Tsui, Kowloon (HK)
- (72) Inventors: **Peter John Cummings**, Kowloon (HK); **Chun Kit Ng**, Kowloon (HK)
- (73) Assignee: **KMA Concepts Limited**, North Point (HK)
- (**) Term: **15 Years**
- (21) Appl. No.: **29/621,388**
- (22) Filed: **Oct. 6, 2017**
- (51) **LOC (11) Cl.** **21-01**
- (52) **U.S. Cl.**
USPC **D21/620; D21/578**
- (58) **Field of Classification Search**
USPC D6/598; D11/158, 162; D21/576-595, D21/611-613, 620; 446/368-369, 376, 446/428, 487; 180/8.6; D30/160
CPC ... A63H 3/00; A63H 3/02; A63H 3/04; A63H 3/16; A63H 3/28; A63H 33/00; A63H 7/06; A63H 11/00; A63H 11/10; A63H 11/20; A63H 13/00
See application file for complete search history.

D385,596 S *	10/1997	Nielsen	D21/620
D385,597 S *	10/1997	Nielsen	D21/620
D402,322 S *	12/1998	Hall	D21/620
D418,551 S *	1/2000	Kageyama	D21/576
D431,270 S *	9/2000	Kawakita	D21/611
D445,849 S *	7/2001	Saito	D21/578
D457,203 S *	5/2002	Onishi	D21/578
6,458,011 B1 *	10/2002	Inoue	A63H 3/006 446/376
D467,630 S *	12/2002	Kawakita	D21/578
6,952,629 B2 *	10/2005	Takamura	G05D 1/0246 250/208.1
D511,188 S *	11/2005	Takeda	D21/585
D531,681 S *	11/2006	Larian	D21/620
D566,794 S *	4/2008	Judkins	A63H 3/16 D21/576
D689,963 S *	9/2013	Thorsen	D21/620
D725,201 S *	3/2015	Shalgi	D21/620
D760,851 S *	7/2016	Cummings	D21/578
D778,372 S *	2/2017	Cummings	D21/578

* cited by examiner

Primary Examiner — Sandra L Morris
(74) *Attorney, Agent, or Firm* — LaMorte & Associates, P.C.

(57) **CLAIM**

The ornamental design for a posable toy horse, as shown and described.

DESCRIPTION

FIG. 1 is a perspective view of a posable toy horse;
FIG. 2 is a front view thereof;
FIG. 3 is a rear view thereof;
FIG. 4 is a right side view thereof;
FIG. 5 is a left side view thereof;
FIG. 6 is a top view thereof; and,
FIG. 7 is a bottom view thereof.

1 Claim, 7 Drawing Sheets

(56) **References Cited**

U.S. PATENT DOCUMENTS

D140,076 S *	1/1945	Caplan et al.	D21/620
D239,554 S *	4/1976	Schoenfield et al.	D21/620
4,186,515 A *	2/1980	Ogawa	A63H 3/16 446/123
D258,371 S *	2/1981	Cox	D21/620
D278,072 S *	3/1985	Urabe	D21/620
D378,840 S *	4/1997	Rahbek	D21/620

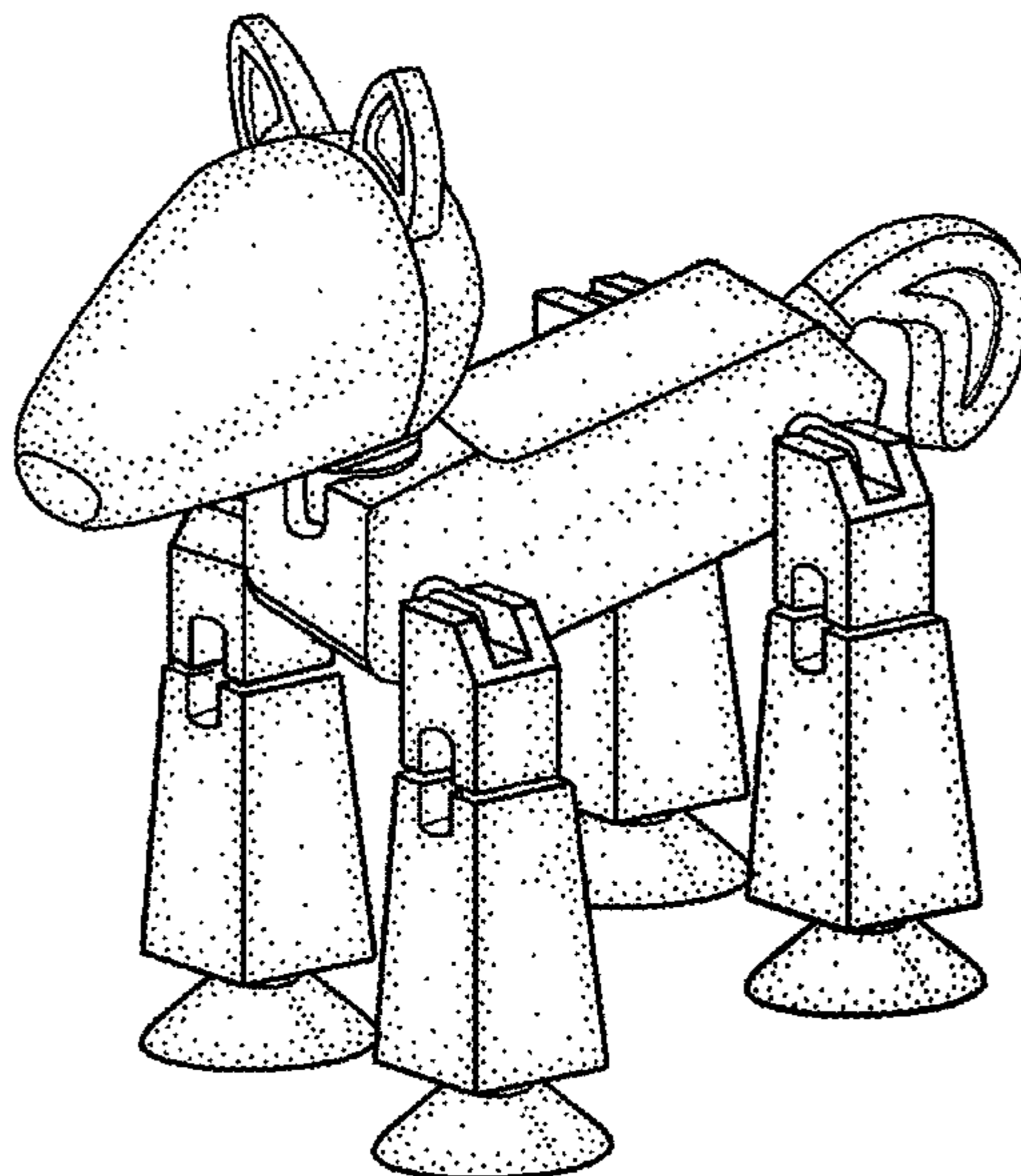

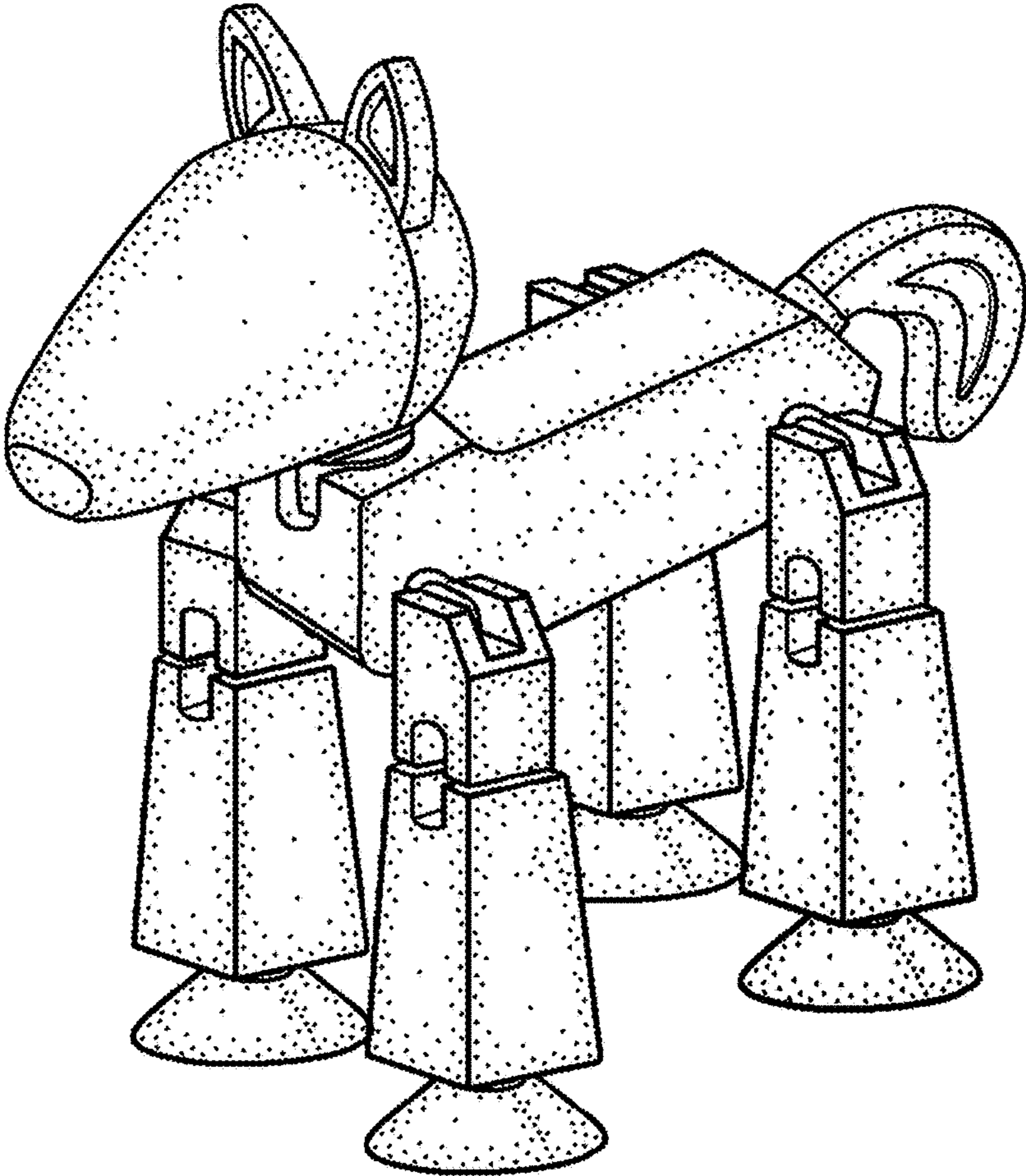

FIG. 1

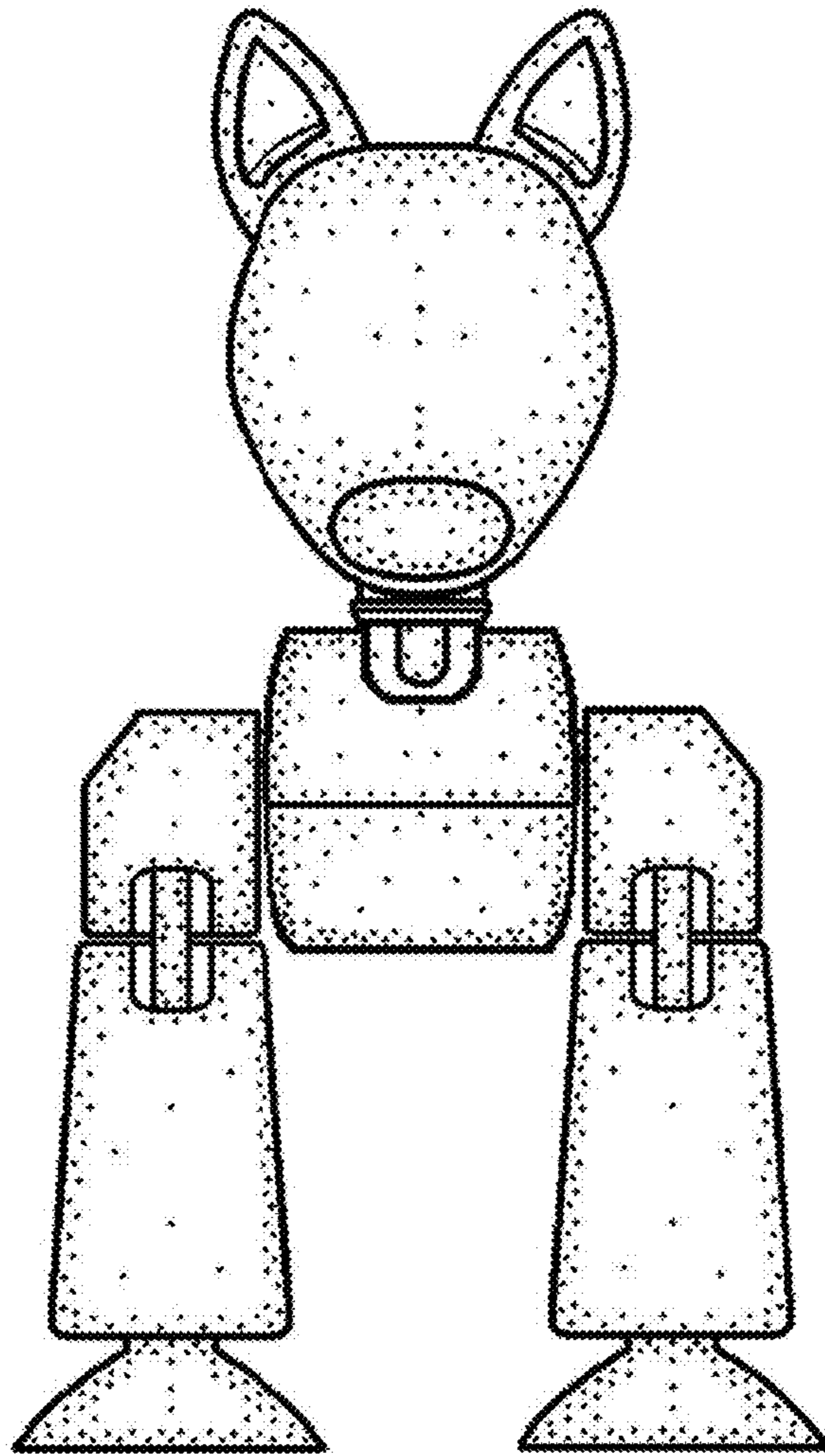

FIG. 2

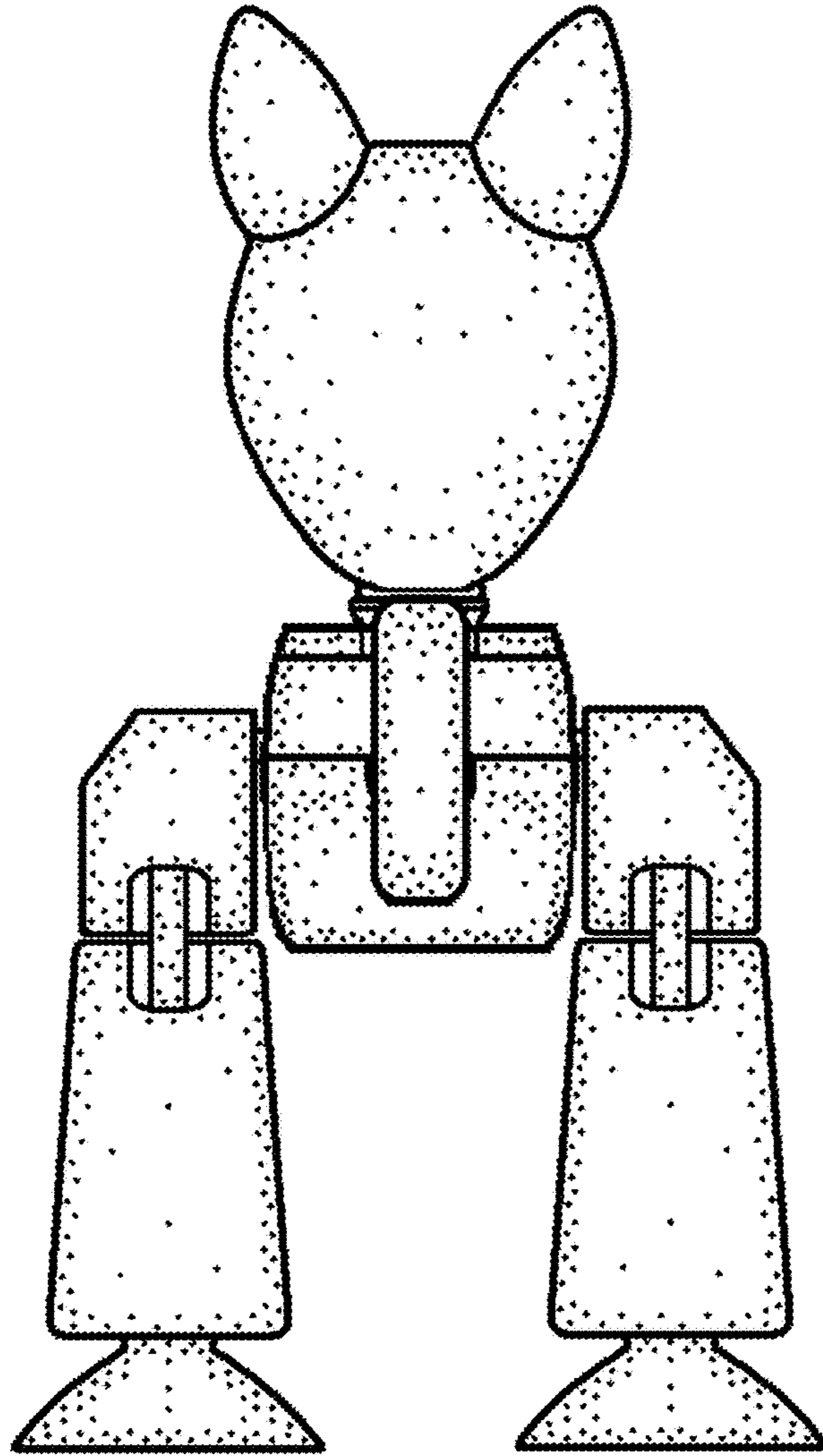

FIG. 3

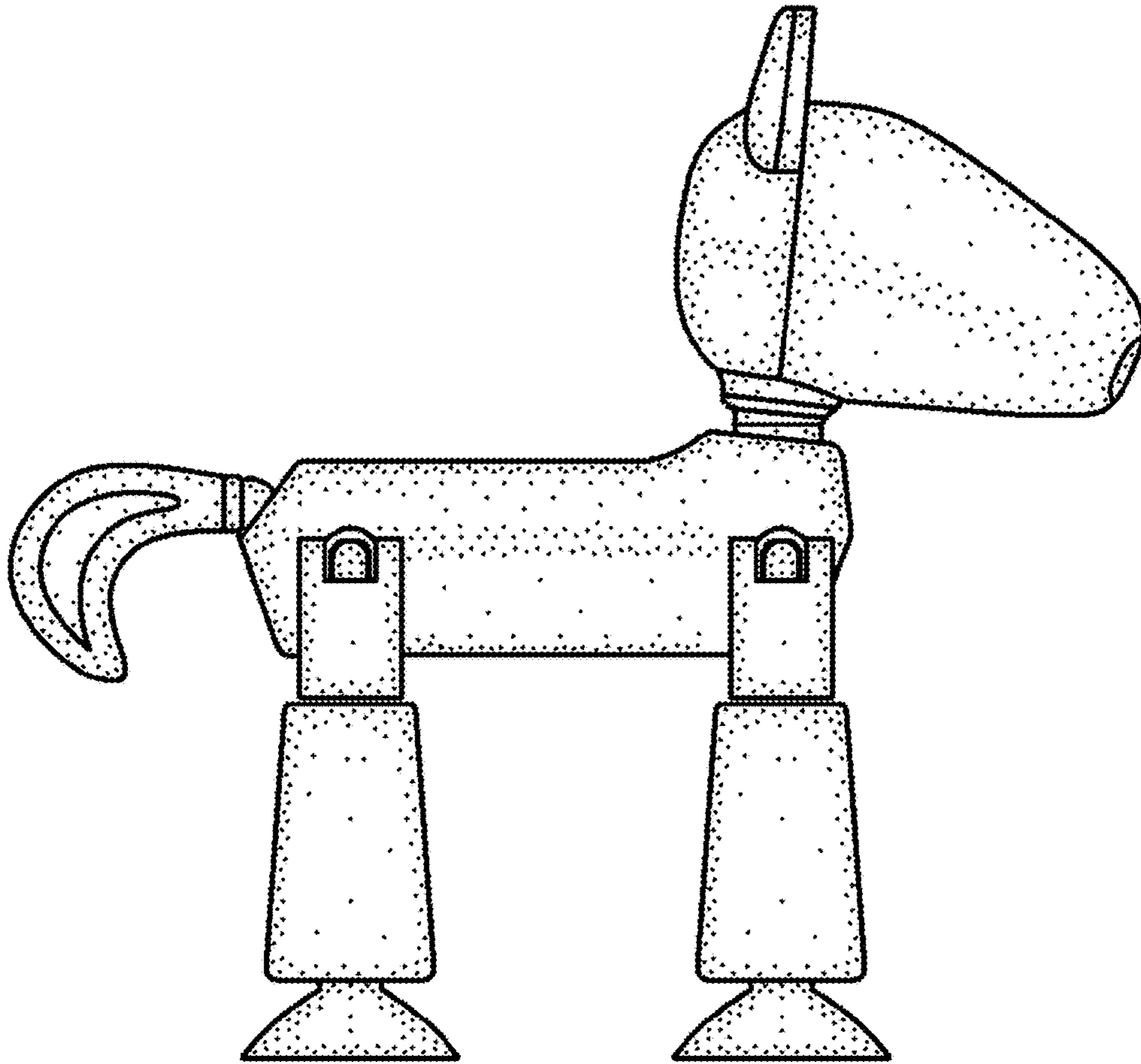

FIG. 4

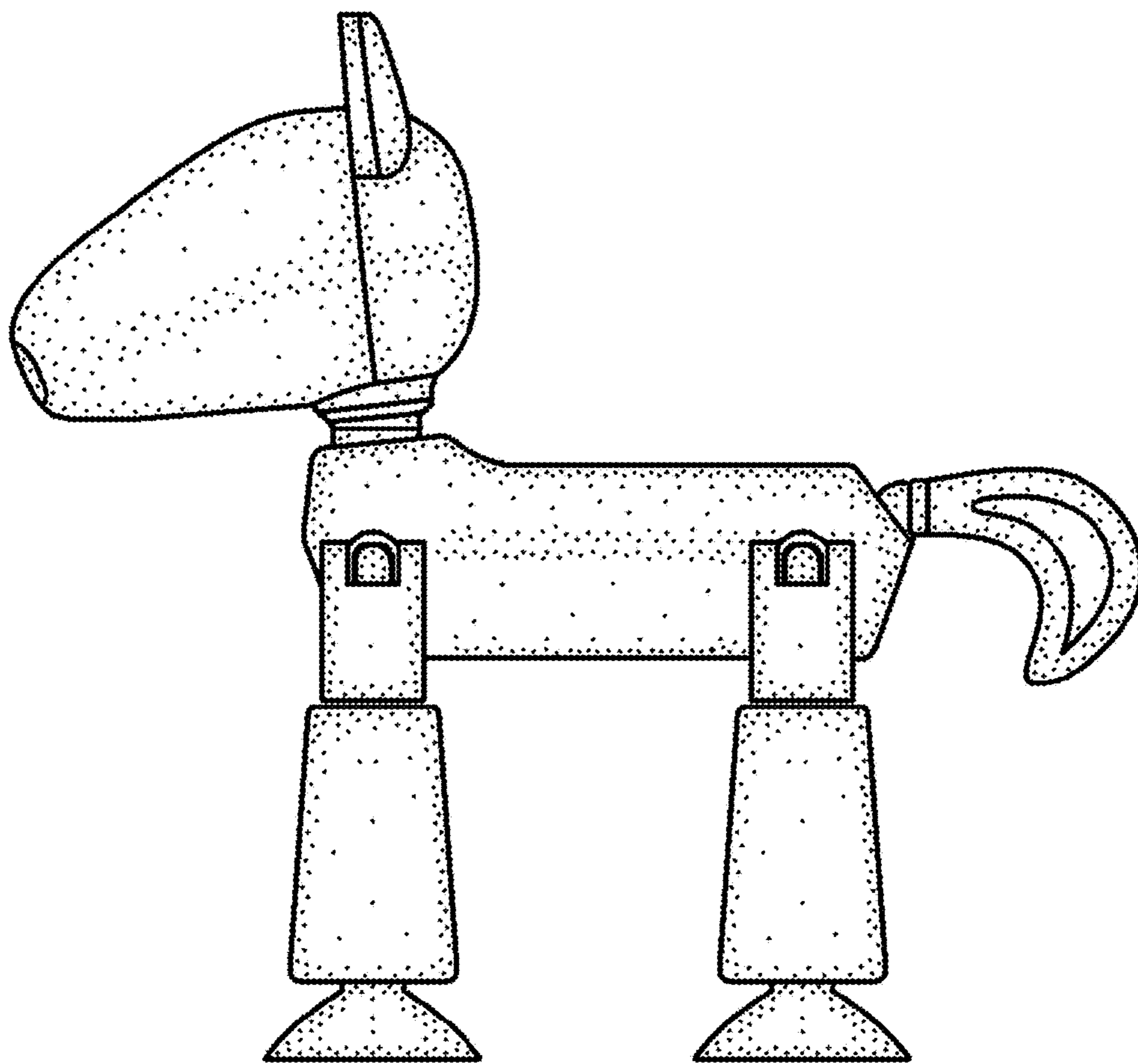

FIG. 5

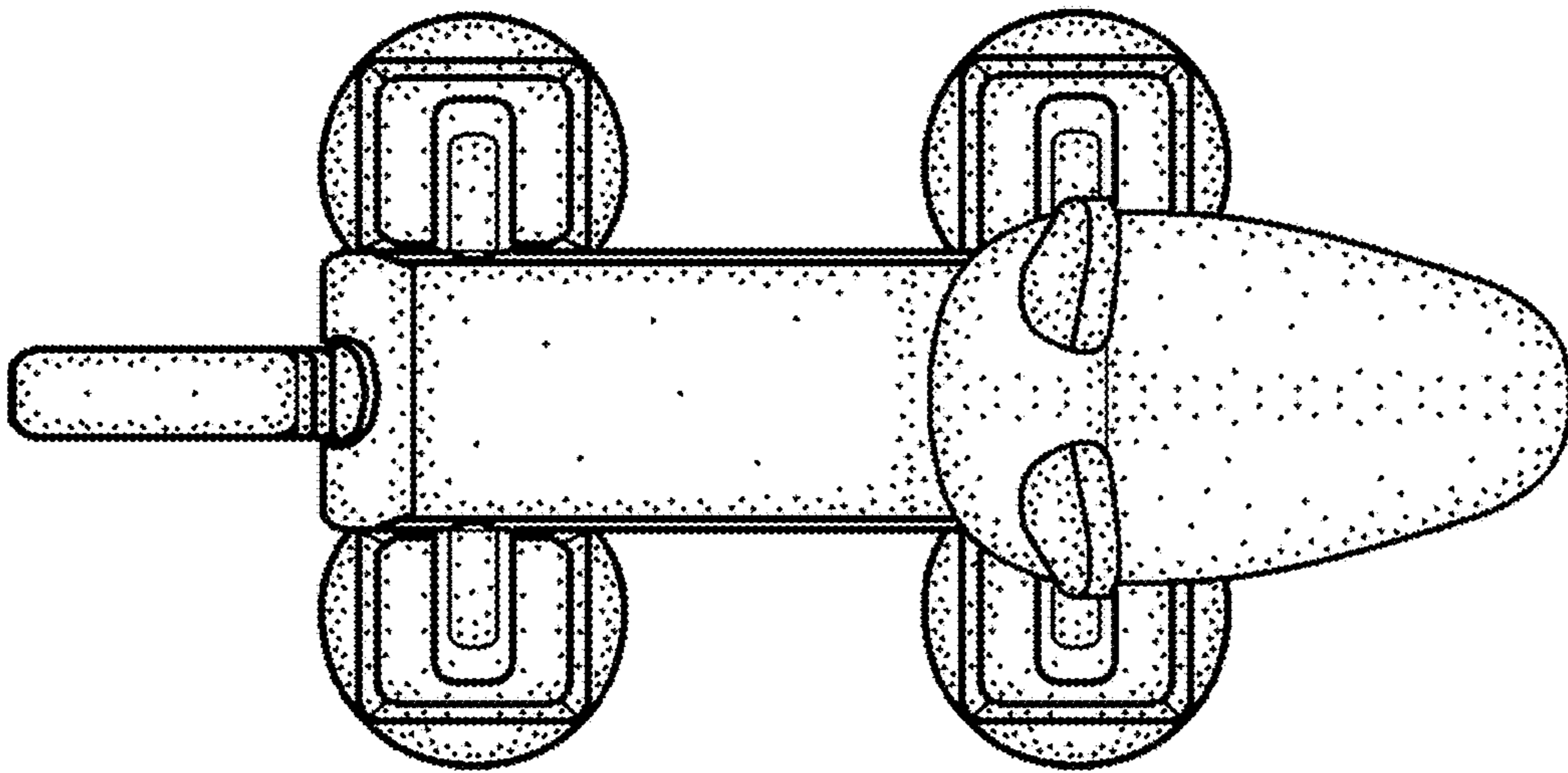

FIG. 6

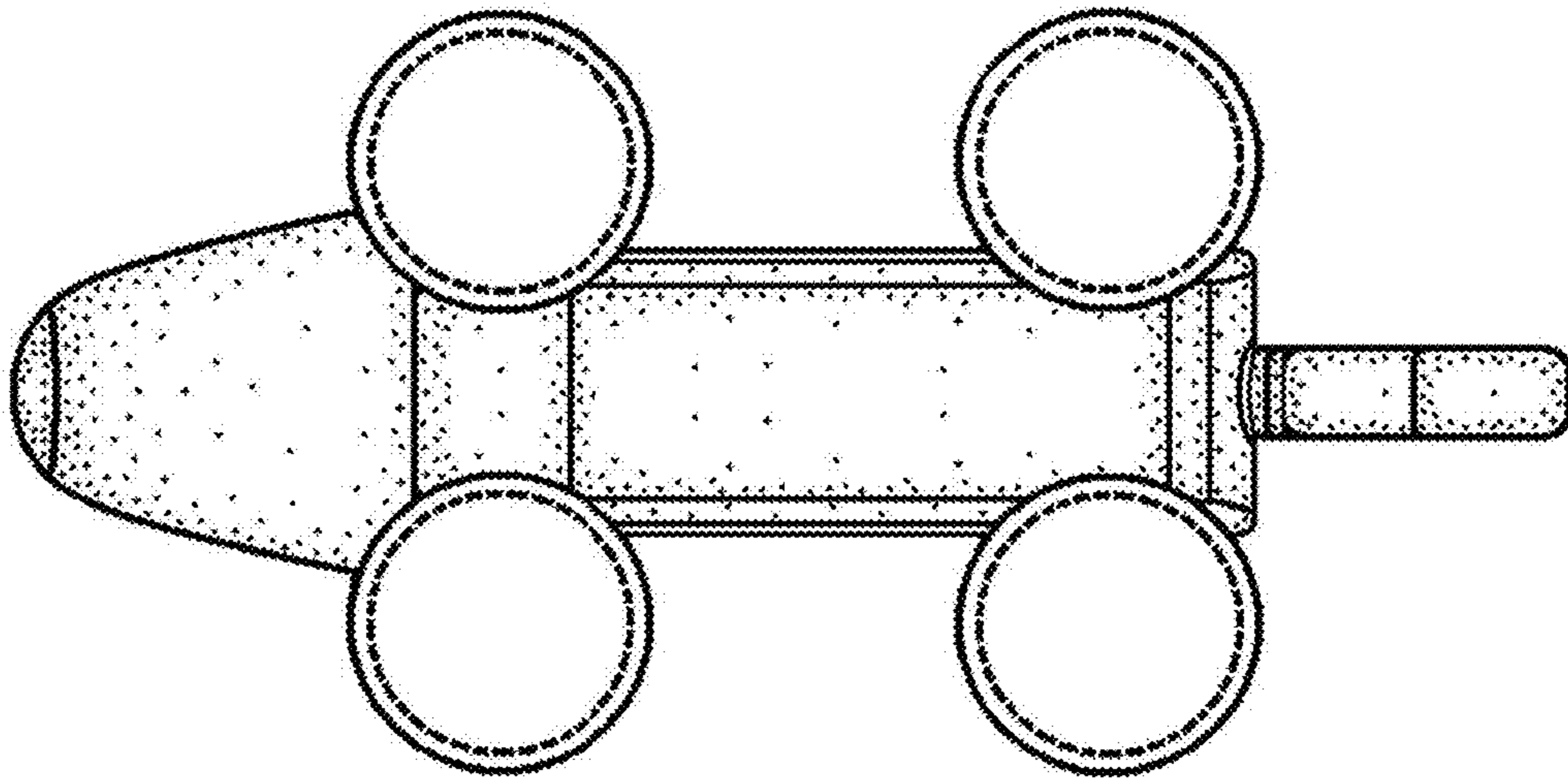

FIG. 7