



US00D848550S

(12) **United States Design Patent** (10) **Patent No.:** **US D848,550 S**
Cummings et al. (45) **Date of Patent:** **** May 14, 2019**

(54) **POSABLE TOY BULLDOG** 6,458,011 B1 * 10/2002 Inoue A63H 3/006
446/376
(71) Applicant: **KMA Concepts Limited**, Tsim Sha D467,630 S * 12/2002 Kawakita D21/578
Tsui, Kowloon (HK) D468,374 S * 1/2003 So D21/611
D468,375 S * 1/2003 So D21/611
(72) Inventors: **Peter John Cummings**, Kowloon 6,952,629 B2 * 10/2005 Takamura G05D 1/0246
(HK); **Chun Kit Ng**, Kowloon (HK) 250/208.1
D511,188 S * 11/2005 Takeda D21/611
D566,795 S * 4/2008 Judkins G05D 1/0246
(73) Assignee: **KMA Concepts Limited**, North Point D21/611
(HK) D667,510 S * 9/2012 Hayakawa A63H 3/006
D21/611
(**) Term: **15 Years** D760,851 S * 7/2016 Cummings D21/578
D778,372 S * 2/2017 Cummings D21/578

(21) Appl. No.: **29/621,377**

* cited by examiner

(22) Filed: **Oct. 6, 2017**

Primary Examiner — Sandra L Morris

(51) **LOC (11) Cl.** **21-01**

(74) *Attorney, Agent, or Firm* — LaMorte & Associates, P.C.

(52) **U.S. Cl.**
USPC **D21/611; D21/578**

(58) **Field of Classification Search**
USPC D6/598; D11/158, 162; D21/576–595,
D21/611–613; 446/368–369, 376, 428,
446/487; 180/8.6; D30/160
CPC ... A63H 3/00; A63H 3/02; A63H 3/04; A63H
3/16; A63H 3/28; A63H 33/00; A63H
7/06; A63H 11/00; A63H 11/10; A63H
11/20; A63H 13/00
See application file for complete search history.

(57) **CLAIM**

The ornamental design for a posable toy bulldog, as shown and described.

DESCRIPTION

FIG. 1 is a perspective view of a posable toy bulldog;
FIG. 2 is a front view thereof;
FIG. 3 is a rear view thereof;
FIG. 4 is a right side view thereof;
FIG. 5 is a left side view thereof;
FIG. 6 is a top view thereof; and,
FIG. 7 is a bottom view thereof.
The broken lines in FIG. 7 are included for the purpose of illustrating a portion of the bottom that forms no part of the claimed design.

(56) **References Cited**
U.S. PATENT DOCUMENTS
D418,551 S * 1/2000 Kageyama D21/611
D445,849 S * 7/2001 Saito D21/611
D448,433 S * 9/2001 Ueda D21/611
D457,203 S * 5/2002 Onishi D21/611
D457,205 S * 5/2002 Hornsby D21/611

1 Claim, 7 Drawing Sheets

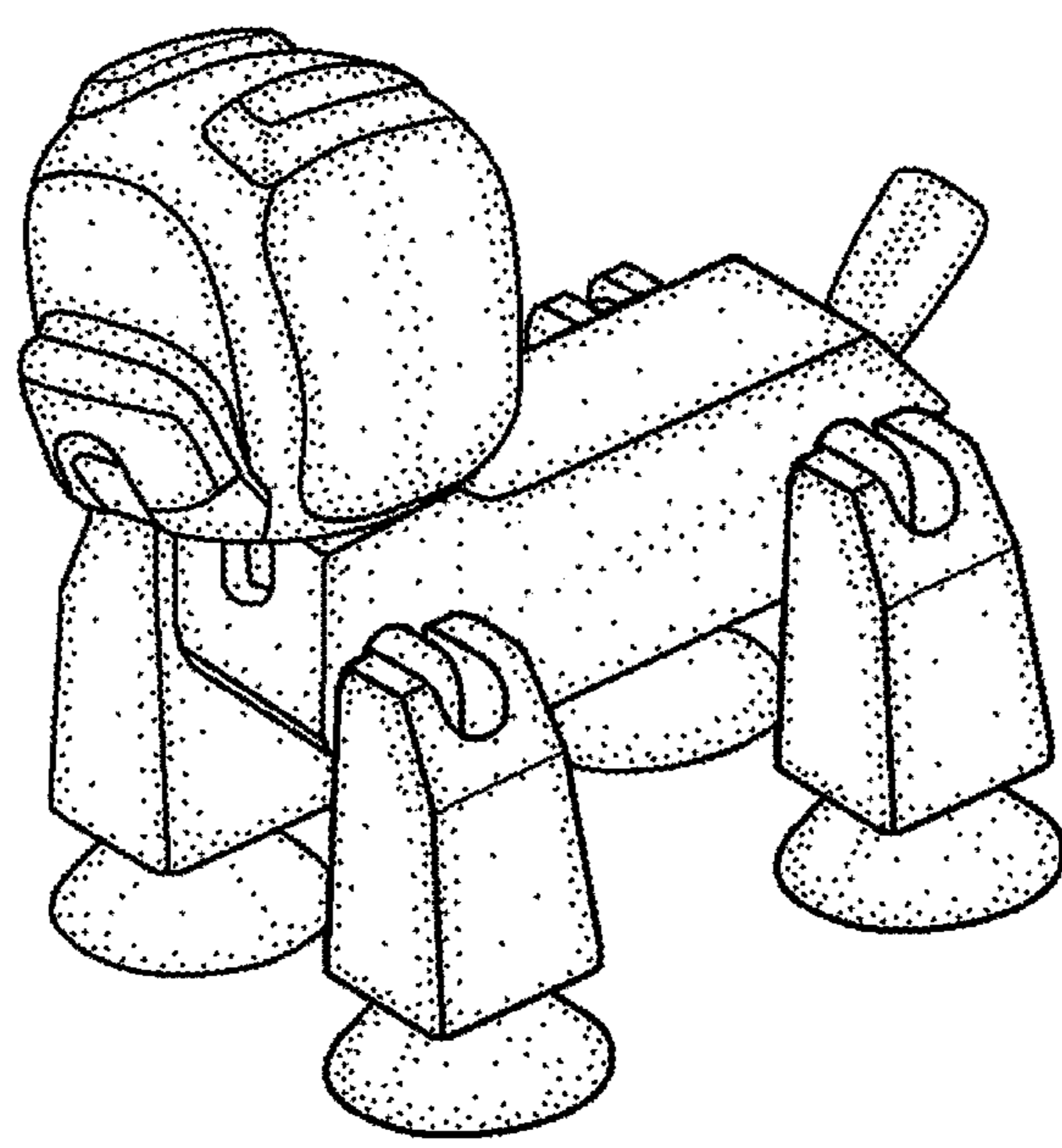

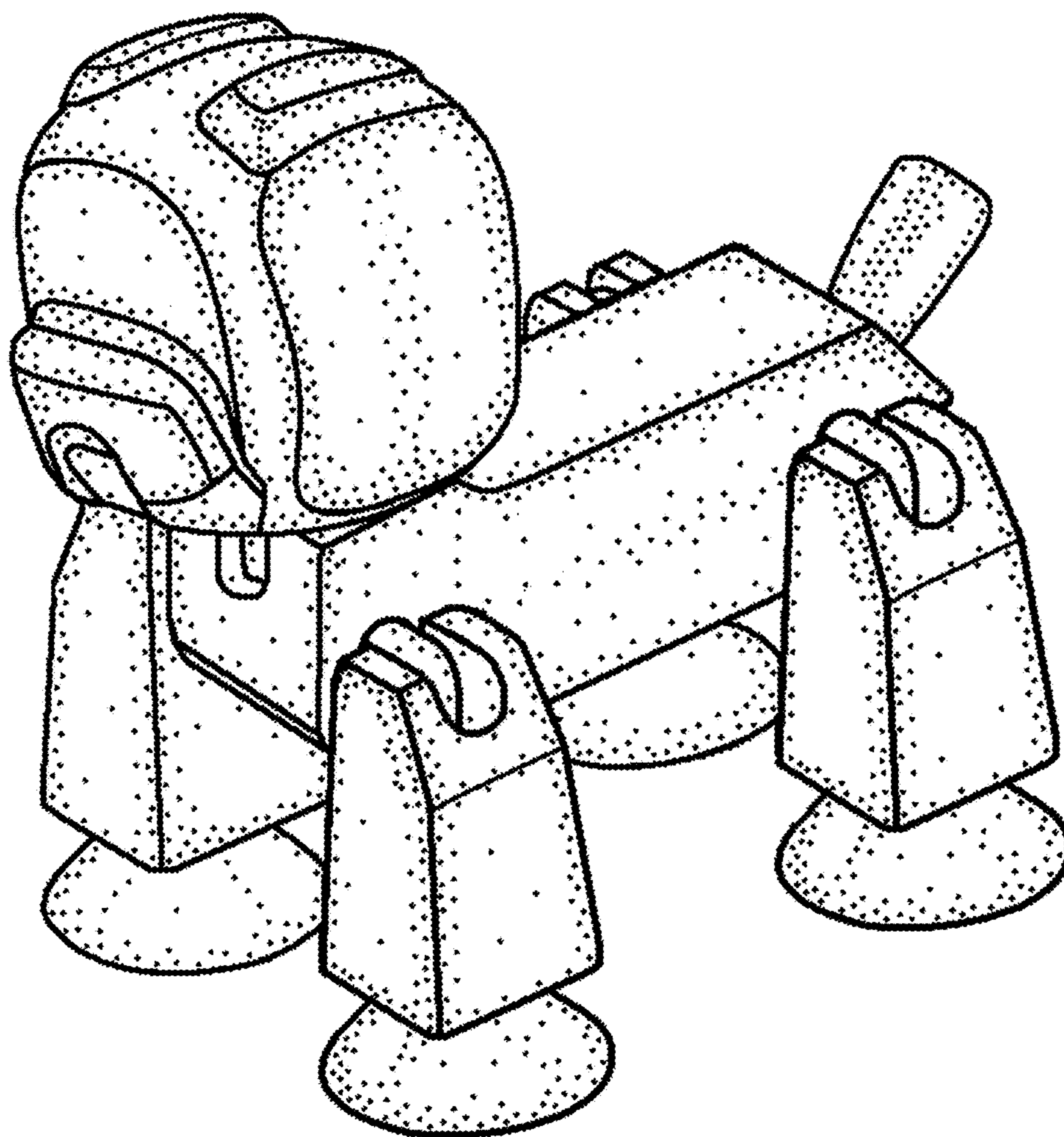

FIG. 1

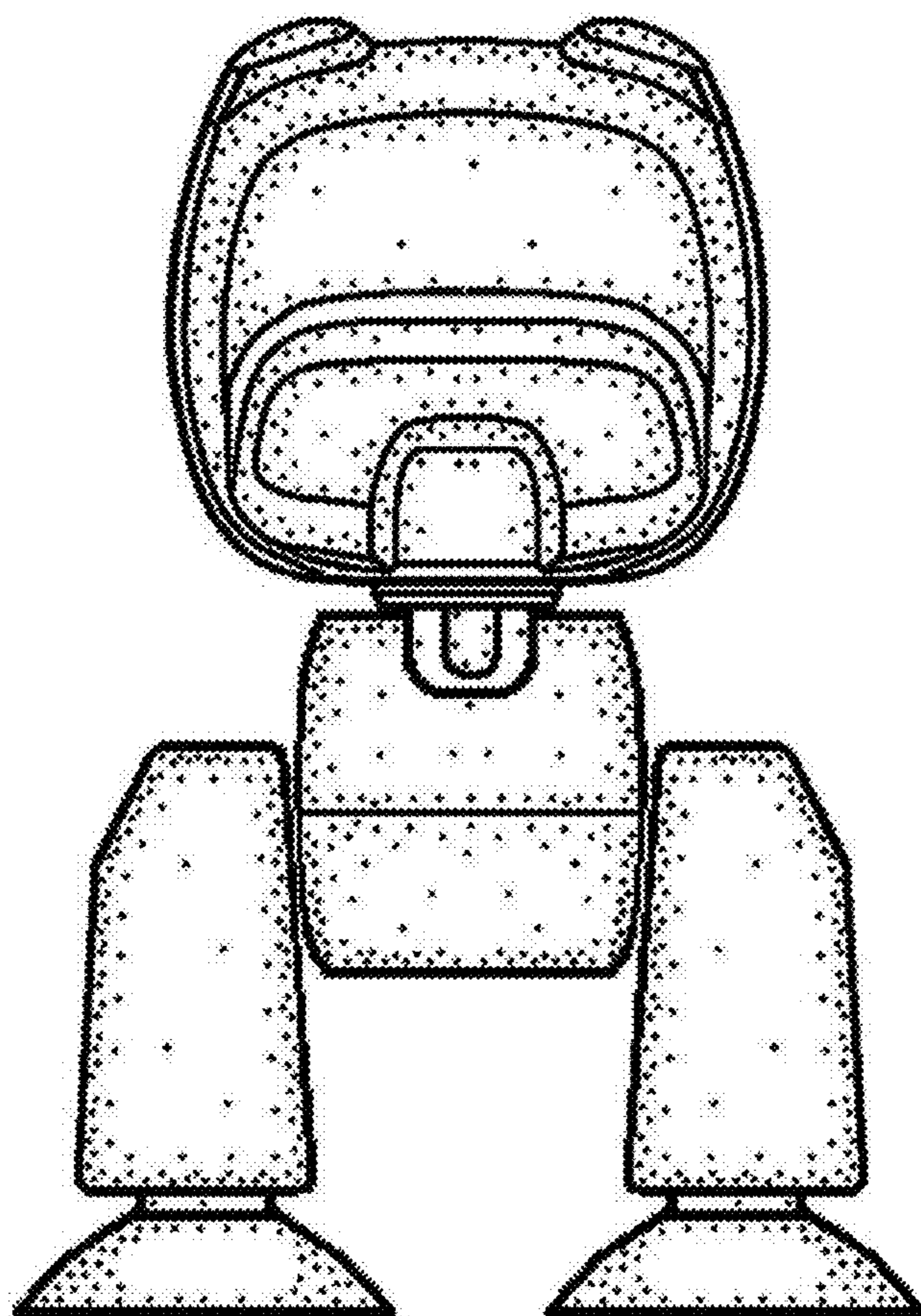

FIG. 2

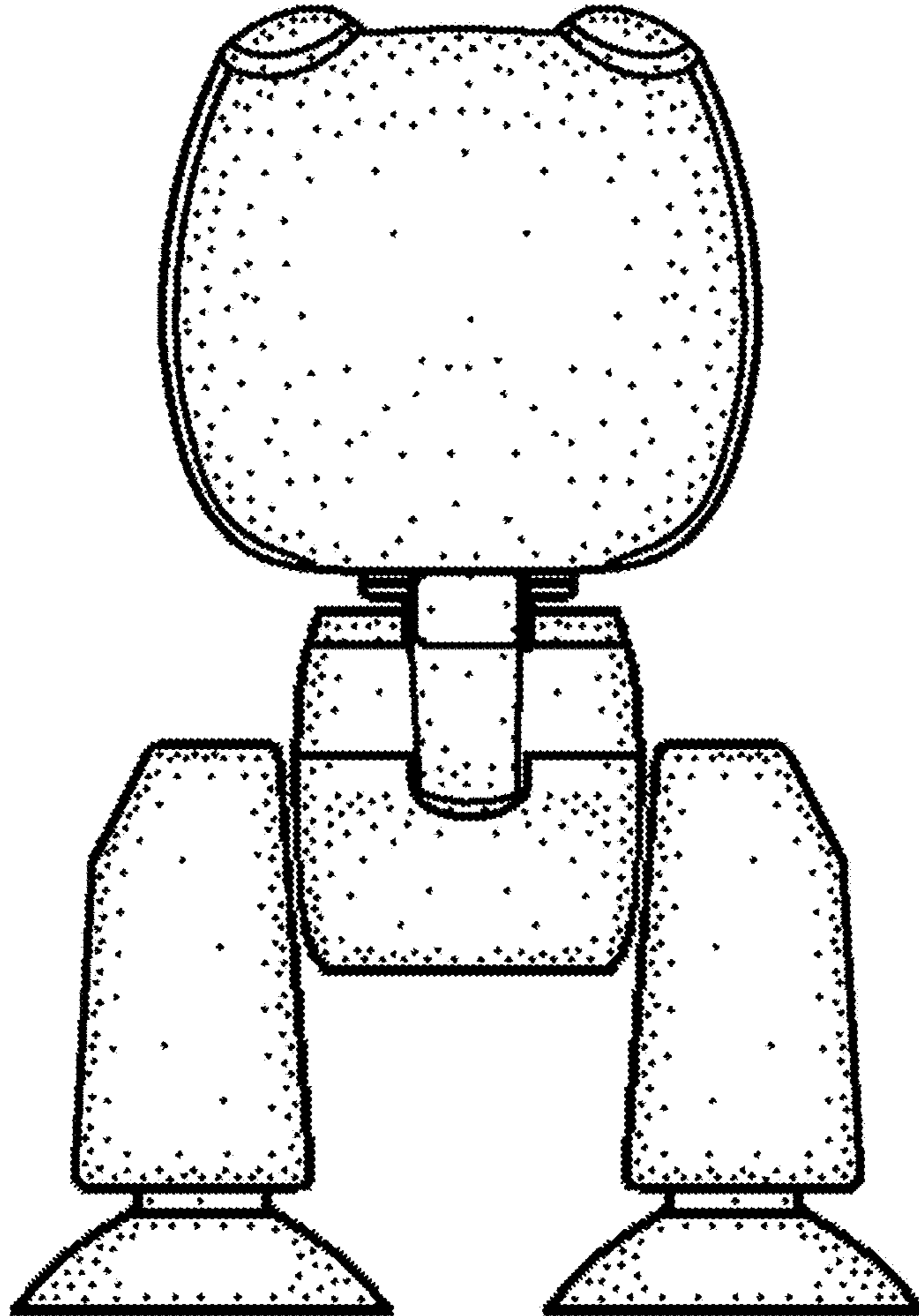

FIG. 3

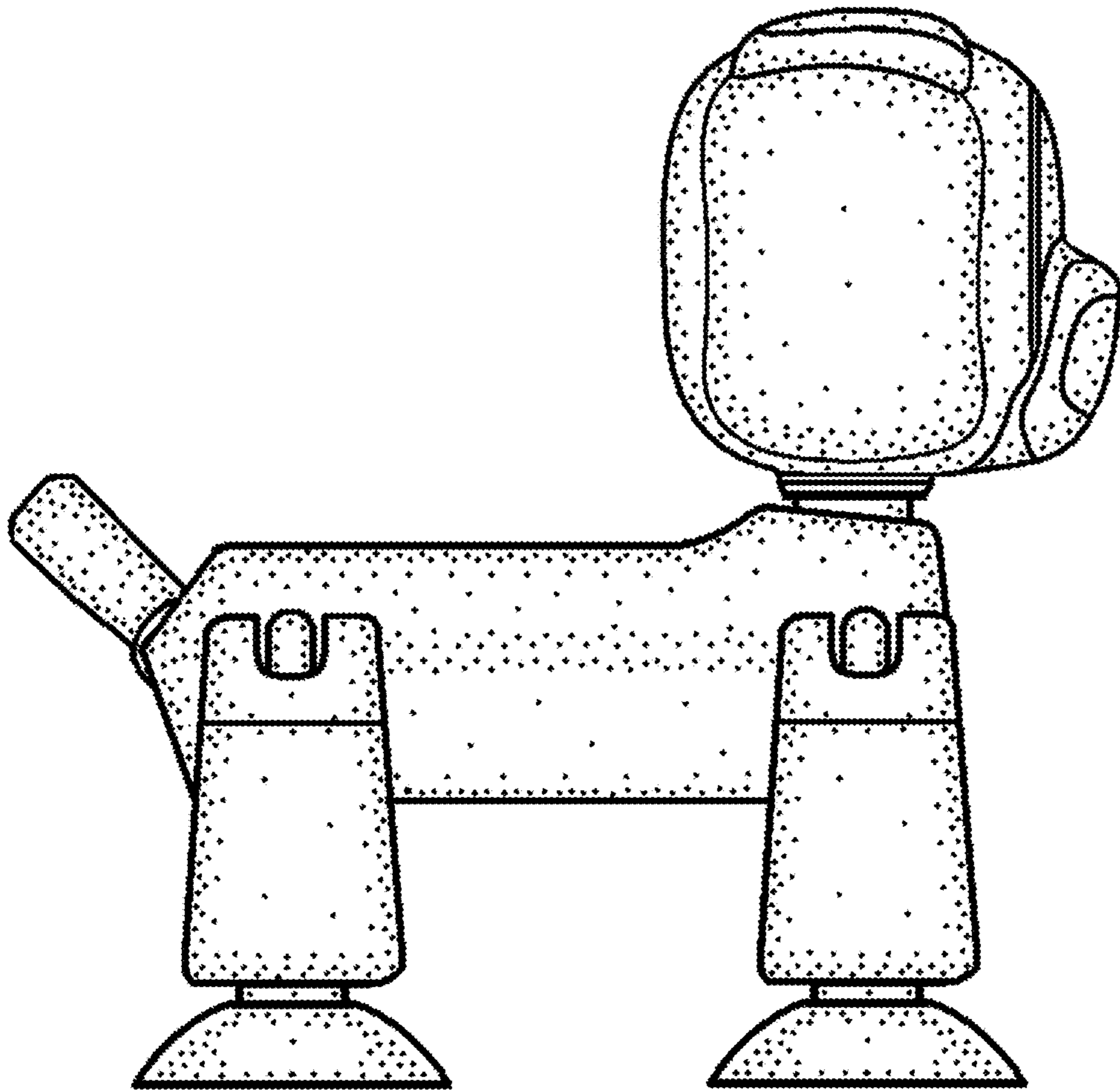

FIG. 4

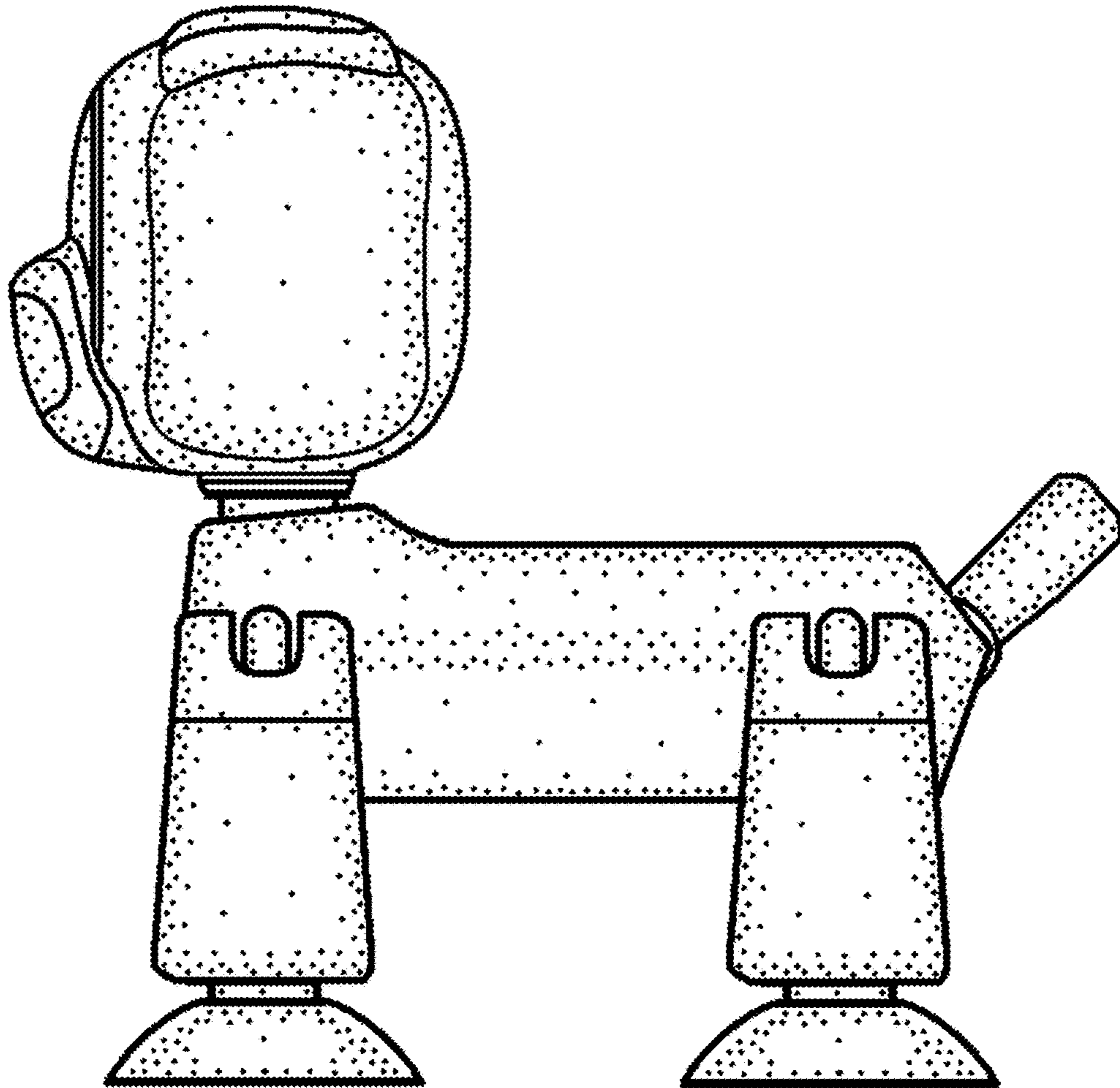

FIG. 5

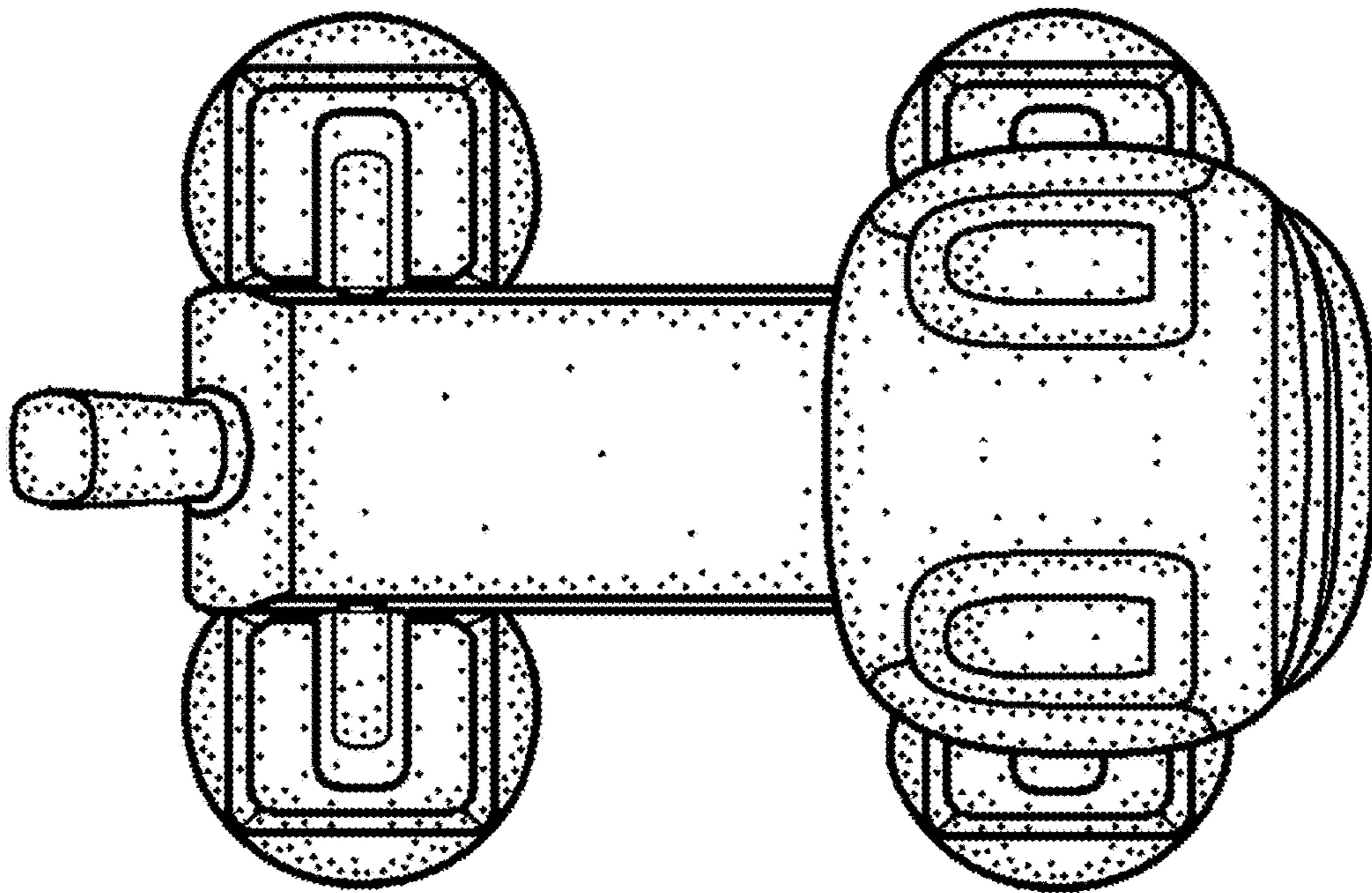

FIG. 6

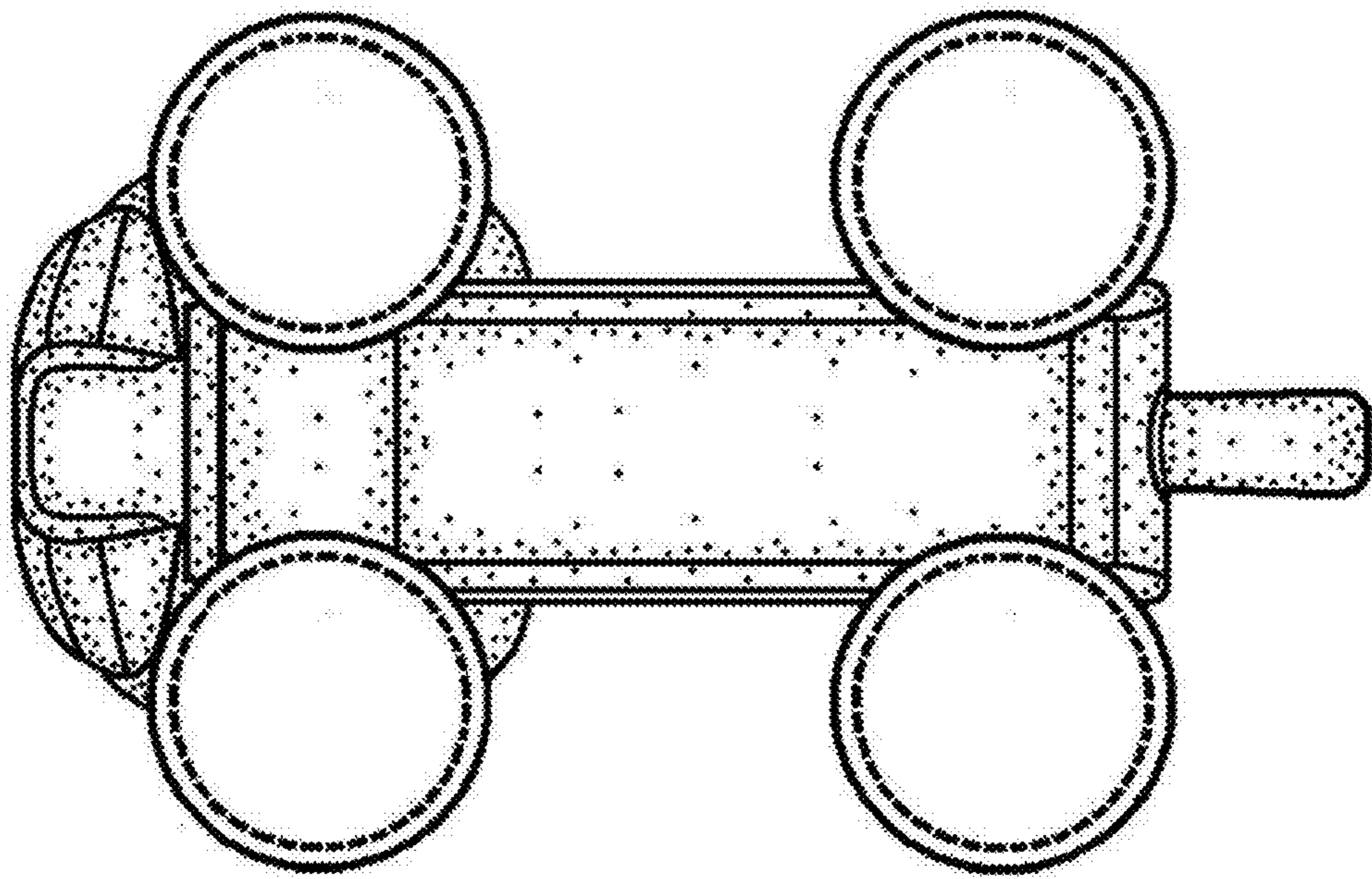

FIG. 7